

Ordinary Location Fittings

Easy Access for Pulling, Splicing, Mounting and Maintenance!

OCAL-BLUE™ Double-Coat Conduit Bodies

With OCAL-BLUE™ Double-Coat Conduit Bodies, you can connect sections of conduit — with or without 90° bends — and provide easy access for wire pulling, making splices in branch conductors and maintenance and future system changes. Conduit bodies can also serve as mounting outlets for wiring devices and lighting fixtures.

- Flat surface molded on conduit body seals with molded flange on cover
- Available in Form 7 and Form 8 ferrous as well as Mark 9 and Form 7 aluminum
- All OCAL-BLUE™ conduit bodies offer double corrosion protection — both bodies and covers coated inside and out with a nominal 0.002 in. (2 mils) blue urethane, then exterior coated with a nominal 0.040 in. (40 mils) PVC
- All threaded hubs fitted with pressure-sealing sleeves
- Conduit bodies ship complete with covers and encapsulated stainless steel screws
- Covers also sold separately for replacement or retrofit purposes



3/4 in. B Form 8 conduit body and cover



2-1/2 in. LB Form 8 conduit body and cover



2-1/2 in. LB Form 7 conduit body and cover



3/4 in. X Form 7 conduit body and cover



3/4 in. LB Mark 9 conduit body and cover

Cat. No.	Material	Colour
LB27	—	— = space for colour identifier
	Blank = Steel	G = Grey
	SA = Aluminum	W = White
		B = Blue
		R = Red
<i>Catalogue No. Example:</i> LB27-W is 3/4 in. LB ferrous conduit body and cover coated in white PVC.		
Custom colours also available - Std. min. quantities are required. Please contact your Regional Sales Office.		



Up to and including 2 in.

Ordinary Location Fittings

OCAL-BLUE™ Conduit Bodies Quick Reference



Up to and including 2 in.

NOTE: Fittings shown uncoated			Size in. (mm) 1/2 in. to 2 in.*								
Shape	Style	1/2 (16)	3/4 (21)	1 (27)	1-1/4 (35)	1-1/2 (41)	2 (53)	2-1/2 (63)	3 (78)	3-1/2 (91)	4 (103)
	Form 7	C17-	C27-	C37-	C47-	C57-	C67-	C77-	C87-	—	—
	Form 8	C18-	C28-	C38-	C448-	C58-	C68-	C78-	C88-	—	—
	Mark 9	C19-	C29-	C39-	C49-	C59-	C69-	C789-	C889-	C989-	C1089-
	Form 7 Aluminum	C17SA-	C27SA-	C37SA-	C47SA-	C57SA-	C67SA-	C77SA-	C87SA-	—	—
	Form 7	L17-	L27-	L37-	L47-	L57-	L67-	—	—	—	—
	Form 7 Aluminum	L17SA-	L27SA-	L37SA-	L47SA-	L57SA-	L67SA-	—	—	—	—
	Double faced — may be use as LL or LR — has 2 openings. Not CSA certified										
	Form 7	LB17-	LB27-	LB37-	LB47-	LB57-	LB67-	LB777-	LB87-	LB97-	LB107-
	Form 8	LB18-	LB28-	LB38-	LB448-	LB58-	LB68-	LB78-	LB888-	LB98-	LB108-
	Mark 9	LB19-	LB29-	LB39-	LB49-	LB59-	LB69-	LB789-	LB889-	LB989-	LB1089-
	Form 7 Aluminum	LB17SA-	LB27SA-	LB37SA-	LB47SA-	LB57SA-	LB67SA-	LB777SA-	LB87SA-	LB97SA-	LB107SA-
	Form 7	LL17-	LL27-	LL37-	LL47-	LL57-	LL67-	LL777-	LL87-	LL97-	LL107-
	Form 8	LL18-	LL28-	LL38-	LL448-	LL58-	LL68-	LL78-	LL888-	—	—
	Mark 9	LL19-	LL29-	LL39-	LL49-	LL59-	LL69-	LL789-	LL889-	LL989-	LL1089-
	Form 7 Aluminum	LL17SA-	LL27SA-	LL37SA-	LL47SA-	LL57SA-	LL67SA-	LL777SA-	LL87SA-	LL97SA-	LL107SA-
	Form 7	LR17-	LR27-	LR37-	LR47-	LR57-	LR67-	LR777-	LR87-	LR97-	LR107-
	Form 8	LR18-	LR28-	LR38-	LR448-	LR58-	LR68-	LR78-	LR888-	—	—
	Mark 9	LR19-	LR29-	LR39-	LR49-	LR59-	LR69-	LR789-	LR889-	LR989-	LR1089-
	Form 7 Aluminum	LR17SA-	LR27SA-	LR37SA-	LR47SA-	LR57SA-	LR67SA-	LR777SA-	LR87SA-	LR97SA-	LR107SA-
	Form 7	T17-	T27-	T37-	T47-	T57-	T67-	T77-	T87-	T97-	T107-
	Form 8	T18-	T28-	T38-	T448-	T58-	T68-	T78-	T88-	—	—
	Mark 9	T19-	T29-	T39-	T49-	T59-	T69-	T789-	T889-	T989-	T1089-
	Form 7 Aluminum	T17SA-	T27SA-	T37SA-	T47SA-	T57SA-	T67SA-	T77SA-	T87SA-	T97SA-	T107SA-
	Form 7	TB17-	TB27-	TB37-	TB47-	TB57-	TB67-	—	—	—	—
	Form 8	TB18-	TB28-	TB38-	TB448-	TB58-	TB68-	—	—	—	—
	Mark 9	TB19-	TB29-	TB39-	TB49-	—	—	—	—	—	—
	Form 7 Aluminum	TB17SA-	TB27SA-	TB37SA-	TB47SA-	TB57SA-	TB67SA-	—	—	—	—
	Form 7	X17-	X27-	X37-	X47-	X57-	X67-	—	—	—	—
	Form 8	X18-	X28-	X38-	X448-	X58-	X68-	—	—	—	—
	Mark 9	X19-	X29-	X39-	—	—	—	—	—	—	—
	Form 7 Aluminum	X17SA-	X27SA-	X37SA-	X47SA-	X57SA-	X67SA-	—	—	—	—

* PVC coated "OCAL-BLUE™" conduit bodies with covers for threaded rigid conduit series C, LB, LL, LR, T, TB and X with supports 28-4X, 38-4X, 448-4X, J8-4X and 6R-4X. Type 4X ratings in 1/2 in. (16) to 2 in. (53) trade size.

OCAL-BLUE™ Conduit Body Covers

		Size in. (mm)									
	STYLE	1/2 (16)	3/4 (21)	1 (27)	1-1/4 (35)	1-1/2 (41)	2 (53)	2-1/2 (63)	3 (78)	3-1/2 (91)	4 (103)
	Form 7	170F-	270F-	370F-	470F-	570F-	670F-	870F-	870F-	970F-	970F-
	Form 8	180F-	280F-	380F-	480F-	580F-	680F-	880F-	880F-	980F-	980F-
	Mark 9	190-	290-	390-	490-	590-	690-	889-	889-	989-	989-
	Form 7 Aluminum	170SA-	270SA-	370SA-	470SA-	570SA-	670SA-	870SA-	870SA-	970SA-	970SA-

Ordinary Location Fittings

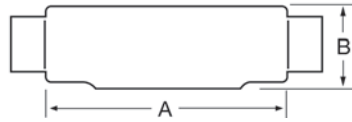

C Form 7 Ferrous Conduit Bodies with Covers

Cat. No.	Hub Size in. (mm)	Dimensions in. (mm)*					Vol. Cap. (cu.in./cu.cm)
		A	B	C	D	E	
C17-	1/2 (16)	5.45 (138.43)	1.40 (35.56)	1.45 (36.83)	0.95 (24.13)	3.20 (81.28)	4.00 (65.55)
C27-	3/4 (21)	6.05 (153.67)	1.60 (40.64)	1.65 (41.91)	1.15 (29.21)	3.80 (96.52)	6.60 (108.15)
C37-	1 (27)	6.75 (171.45)	1.90 (48.26)	1.80 (45.72)	1.35 (34.29)	4.55 (115.57)	10.60 (173.70)
C47-	1-1/4 (35)	7.30 (185.42)	2.30 (58.42)	2.20 (55.88)	1.80 (45.72)	5.00 (127.00)	18.80 (308.08)
C57-	1-1/2 (41)	8.60 (218.44)	2.60 (66.04)	2.45 (62.23)	2.05 (52.07)	5.45 (138.43)	26.40 (432.62)
C67-	2 (53)	9.50 (241.30)	3.20 (81.28)	3.05 (77.47)	2.45 (62.23)	6.40 (162.56)	51.00 (835.74)
C77-	2-1/2 (63)	12.10 (307.34)	3.65 (92.71)	4.25 (107.95)	3.60 (91.44)	8.40 (213.36)	102.00 (1671.48)
C87-	3 (78)	12.10 (307.34)	4.40 (111.76)	4.25 (107.95)	3.60 (91.44)	8.40 (213.36)	132.00 (2163.09)

C Mark 9 Aluminium Conduit Bodies with Covers

Cat. No.	Hub Size in. (mm)	Dimensions in. (mm)*					Vol. Cap. (cu.in./cu.cm)
		A	B	C	D	E	
C19-	1/2 (16)	5.00 (127.00)	1.38 (35.05)	1.38 (35.05)	1.19 (30.23)	3.31 (84.07)	—
C29-	3/4 (21)	5.69 (144.53)	1.63 (41.40)	1.56 (39.62)	1.38 (35.05)	3.94 (100.08)	—
C39-	1 (27)	6.59 (167.39)	1.88 (47.75)	1.75 (44.45)	1.50 (38.10)	4.56 (115.82)	—
C49-	1-1/4 (35)	7.50 (190.50)	2.50 (63.50)	2.19 (55.63)	1.94 (49.28)	5.31 (134.87)	—
C59-	1-1/2 (41)	8.25 (209.55)	2.75 (69.85)	2.50 (63.50)	2.25 (57.15)	6.00 (152.40)	—
C69-	2 (53)	10.50 (266.70)	3.44 (87.38)	3.19 (81.03)	2.88 (73.15)	8.06 (204.72)	—
C789-	2-1/2 (63)	15.63 (397.00)	4.44 (112.78)	5.00 (127.00)	4.25 (107.95)	10.88 (276.35)	—
C889-	3 (78)	15.63 (397.00)	4.81 (122.17)	5.00 (127.00)	4.25 (107.95)	10.88 (276.35)	—
C989-	3-1/2 (91)	18.75 (476.25)	5.69 (144.53)	6.25 (158.75)	5.44 (138.18)	13.44 (341.38)	—
C1089-	4 (103)	18.75 (476.25)	5.94 (150.88)	6.25 (158.75)	5.44 (138.18)	13.44 (341.38)	—

C Form 8 Ferrous Conduit Bodies with Covers

Cat. No.	Hub Size in. (mm)	Dimensions in. (mm)*					Vol. Cap. (cu.in./cu.cm)
		A	B	C	D	E	
C18-	1/2 (16)	5.53 (140.49)	1.44 (36.51)	1.38 (34.93)	1.00 (25.40)	3.31 (84.14)	4.90 (80.30)
C28-	3/4 (21)	6.28 (159.54)	1.53 (38.89)	1.19 (30.16)	1.19 (30.16)	3.94 (100.01)	8.00 (131.10)
C38-	1 (27)	7.31 (185.74)	1.94 (49.21)	1.75 (44.45)	1.38 (34.93)	4.56 (115.89)	13.00 (213.03)
C448-	1-1/4 (35)	8.50 (215.90)	2.38 (60.33)	2.19 (55.56)	1.75 (44.45)	5.31 (134.94)	23.50 (385.10)
C58-	1-1/2 (41)	10.38 (263.53)	2.78 (70.64)	2.75 (69.85)	2.13 (53.98)	6.50 (165.10)	45.00 (737.42)
C68-	2 (53)	12.25 (311.15)	3.56 (90.49)	3.75 (95.25)	3.00 (76.20)	8.56 (217.49)	88.00 (1442.06)
C78-	2-1/2 (63)	15.63 (396.88)	4.44 (112.71)	5.00 (127.00)	4.25 (107.95)	10.88 (276.23)	110.00 (1802.58)
C88-	3 (78)	15.63 (396.88)	4.81 (122.24)	5.00 (127.00)	4.25 (107.95)	10.88 (276.23)	110.00 (1802.58)

C Form 7 Aluminum Conduit Bodies with Covers

Cat. No.	Hub Size in. (mm)	Dimensions in. (mm)*					Vol. Cap. (cu.in./cu.cm)
		A	B	C	D	E	
C17SA-	1/2 (16)	5.45 (138.43)	1.40 (35.56)	1.45 (36.83)	0.95 (24.13)	3.20 (81.28)	4.00 (65.55)
C27SA-	3/4 (21)	6.05 (153.67)	1.60 (40.64)	1.65 (41.91)	1.15 (29.21)	3.80 (96.52)	6.60 (108.15)
C37SA-	1 (27)	6.75 (171.45)	1.90 (48.26)	1.80 (45.72)	1.35 (34.29)	4.55 (115.57)	10.60 (173.70)
C47SA-	1-1/4 (35)	7.30 (185.42)	2.30 (58.42)	2.20 (55.88)	1.80 (45.72)	5.00 (127.00)	18.80 (308.08)
C57SA-	1-1/2 (41)	8.60 (218.44)	2.60 (66.04)	2.45 (62.23)	2.05 (52.07)	5.45 (138.43)	26.40 (432.62)
C67SA-	2 (53)	9.50 (241.30)	3.20 (81.28)	3.05 (77.47)	2.45 (62.23)	6.40 (162.56)	51.00 (835.74)
C77SA-	2-1/2 (63)	12.10 (307.34)	3.65 (92.71)	4.25 (107.95)	3.60 (91.44)	8.40 (213.36)	102.00 (1671.48)
C87SA-	3 (78)	12.10 (307.34)	4.40 (111.76)	4.25 (107.95)	3.60 (91.44)	8.40 (213.36)	132.00 (2163.09)

Metric size designator (ANSI C80.1-1994). * Dimensions shown are for uncoated conduit bodies.

Ordinary Location Fittings

LB

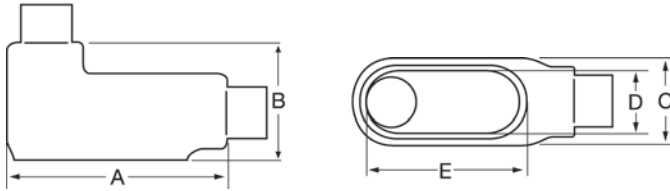

LB Form 7 Ferrous Conduit Bodies with Covers

Cat. No.	Hub Size in. (mm)	Dimensions in. (mm)*					Vol. Cap. (cu.in./cu.cm)
		A	B	C	D	E	
LB17-	1/2 (16)	4.60 (116.84)	2.20 (55.88)	1.35 (34.29)	0.95 (24.13)	3.20 (81.28)	4.00 (65.55)
LB27-	3/4 (21)	5.25 (133.35)	2.40 (60.96)	1.65 (41.91)	1.15 (29.21)	3.80 (96.52)	6.60 (108.15)
LB37-	1 (27)	6.00 (152.40)	2.65 (67.31)	1.80 (45.72)	1.35 (34.29)	4.55 (115.57)	10.60 (173.70)
LB47-	1-1/4 (35)	6.45 (163.83)	3.20 (81.28)	2.20 (55.88)	1.80 (45.72)	5.00 (127.00)	18.80 (308.08)
LB57-	1-1/2 (41)	7.25 (184.15)	3.90 (99.06)	2.45 (62.23)	2.05 (52.07)	5.45 (138.43)	26.40 (432.62)
LB67-	2 (53)	8.30 (210.82)	4.45 (113.03)	3.10 (78.74)	2.45 (62.23)	6.40 (162.56)	51.00 (835.74)
LB777-	2-1/2 (63)	10.55 (267.97)	5.20 (132.08)	4.25 (107.95)	3.60 (91.44)	8.40 (213.36)	102.00 (1671.48)
LB87-	3 (78)	10.55 (267.97)	5.95 (151.13)	4.25 (107.95)	3.60 (91.44)	8.40 (213.36)	132.00 (2163.09)
LB97-	3-1/2 (91)	12.85 (326.39)	6.70 (170.18)	5.25 (133.35)	4.55 (115.57)	10.25 (260.35)	210.00 (3441.28)
LB107-	4 (103)	12.85 (326.39)	7.20 (182.88)	5.25 (133.35)	4.55 (115.57)	10.25 (260.35)	243.00 (3982.06)

LB Mark 9 Aluminum Conduit Bodies with Covers

Cat. No.	Hub Size in. (mm)	Dimensions in. (mm)*					Vol. Cap. (cu.in./cu.cm)
		A	B	C	D	E	
LB19-	1/2 (16)	4.59 (116.68)	2.13 (53.98)	1.38 (34.93)	1.19 (30.16)	3.31 (84.14)	—
LB29-	3/4 (21)	5.25 (133.35)	2.41 (61.12)	1.56 (39.69)	1.38 (34.93)	3.94 (100.01)	—
LB39-	1 (27)	6.09 (154.78)	2.84 (72.23)	1.75 (44.45)	1.50 (38.10)	4.56 (115.89)	—
LB49-	1-1/4 (35)	7.03 (178.59)	3.47 (88.11)	2.19 (55.56)	1.94 (49.21)	5.31 (134.94)	—
LB59-	1-1/2 (41)	7.75 (196.85)	3.75 (95.25)	2.50 (63.50)	2.25 (57.15)	6.00 (152.40)	—
LB69-	2 (53)	10.03 (254.79)	4.47 (113.51)	3.19 (80.96)	2.88 (73.03)	8.06 (204.79)	—
LB789-	2-1/2 (63)	13.94 (354.01)	6.13 (155.58)	5.00 (127.00)	4.25 (107.95)	10.88 (276.23)	—
LB889-	3 (78)	13.94 (354.01)	6.50 (165.10)	5.00 (127.00)	4.25 (107.95)	10.88 (276.23)	—
LB989-	3-1/2 (91)	16.88 (428.63)	7.56 (192.09)	6.25 (158.75)	5.44 (138.11)	13.44 (341.31)	—
LB1089-	4 (103)	16.88 (428.63)	7.81 (198.44)	6.25 (158.75)	5.44 (138.11)	13.44 (341.31)	—

LB Form 8 Ferrous Conduit Bodies with Covers

Cat. No.	Hub Size in. (mm)	Dimensions in. (mm)*					Vol. Cap. (cu.in./cu.cm)
		A	B	C	D	E	
LB18-	1/2 (16)	4.94 (125.41)	2.22 (56.36)	1.38 (34.93)	1.00 (25.40)	3.31 (84.14)	4.90 (80.30)
LB28-	3/4 (21)	5.56 (141.29)	2.44 (61.93)	1.56 (39.69)	1.19 (30.16)	3.31 (84.14)	8.00 (131.10)
LB38-	1 (27)	6.50 (165.10)	2.81 (71.45)	1.75 (44.45)	1.38 (34.93)	4.56 (115.89)	13.00 (213.03)
LB448-	1-1/4 (35)	7.53 (191.29)	3.34 (84.93)	2.19 (55.56)	1.75 (44.45)	5.31 (134.94)	23.50 (385.10)
LB58-	1-1/2 (41)	9.13 (231.78)	4.03 (102.39)	2.75 (69.85)	2.13 (53.98)	6.50 (165.10)	45.00 (737.42)
LB68-	2 (53)	11.00 (279.40)	4.41 (111.92)	3.75 (95.25)	3.00 (76.20)	8.56 (217.49)	88.00 (1442.06)
LB78-	2-1/2 (63)	13.94 (354.01)	6.13 (155.58)	5.00 (127.00)	4.25 (107.95)	10.88 (276.23)	110.00 (1802.58)
LB888-	3 (78)	13.94 (354.01)	6.50 (165.10)	5.00 (127.00)	4.25 (107.95)	10.88 (276.23)	110.00 (1802.58)
LB98-	3-1/2 (91)	16.88 (428.63)	7.56 (192.09)	6.25 (158.75)	5.44 (138.11)	13.44 (341.31)	250.00 (4096.77)
LB108-	4 (103)	16.88 (428.63)	7.81 (198.44)	6.25 (158.75)	5.44 (138.11)	13.44 (341.31)	250.00 (4096.77)

LB Form 7 Aluminum Conduit Bodies with Covers

Cat. No.	Hub Size in. (mm)	Dimensions in. (mm)*					Vol. Cap. (cu.in./cu.cm)
		A	B	C	D	E	
LB17SA-	1/2 (16)	4.60 (116.84)	2.20 (55.88)	1.35 (34.29)	0.95 (24.13)	3.20 (81.28)	4.00 (65.55)
LB27SA-	3/4 (21)	5.25 (133.35)	2.40 (60.96)	1.65 (41.91)	1.15 (29.21)	3.80 (96.52)	6.60 (108.15)
LB37SA-	1 (27)	6.00 (152.40)	2.65 (67.31)	1.80 (45.72)	1.35 (34.29)	4.55 (115.57)	10.60 (173.70)
LB47SA-	1-1/4 (35)	6.45 (163.83)	3.20 (81.28)	2.20 (55.88)	1.80 (45.72)	5.00 (127.00)	18.80 (308.08)
LB57SA-	1-1/2 (41)	7.25 (184.15)	3.90 (99.06)	2.45 (62.23)	2.05 (52.07)	5.45 (138.43)	26.40 (432.62)
LB67SA-	2 (53)	8.30 (210.82)	4.45 (113.03)	3.10 (78.74)	2.45 (62.23)	6.40 (162.56)	51.00 (835.74)
LB777SA-	2-1/2 (63)	10.55 (267.97)	5.20 (132.08)	4.25 (107.95)	3.60 (91.44)	8.40 (213.36)	102.00 (1671.48)
LB87SA-	3 (78)	10.55 (267.97)	5.95 (151.13)	4.25 (107.95)	3.60 (91.44)	8.40 (213.36)	132.00 (2163.09)
LB97SA-	3-1/2 (91)	12.85 (326.39)	6.70 (170.18)	5.25 (133.35)	4.55 (115.57)	10.25 (260.35)	210.00 (3441.28)
LB107SA-	4 (103)	12.85 (326.39)	7.20 (182.88)	5.25 (133.35)	4.55 (115.57)	10.25 (260.35)	243.00 (3982.06)

Metric size designator (ANSI C80.1-1994). * Dimensions shown are for uncoated conduit bodies.

Ordinary Location Fittings

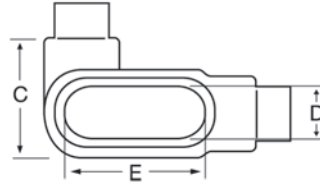
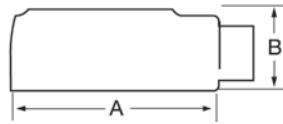

LL Form 7 Ferrous Conduit Bodies with Covers

Cat. No.	Hub Size in. (mm)	Dimensions in. (mm)*					Vol. Cap. (cu.in./cu.cm)
		A	B	C	D	E	
LL17-	1/2 (16)	4.60 (116.84)	1.40 (35.56)	1.45 (36.83)	0.95 (24.13)	3.20 (81.28)	4.00 (65.55)
LL27-	3/4 (21)	5.25 (133.35)	1.60 (40.64)	1.65 (41.91)	1.15 (29.21)	3.80 (96.52)	6.60 (108.15)
LL37-	1 (27)	6.00 (152.40)	1.90 (48.26)	2.60 (66.04)	1.35 (34.29)	4.55 (115.57)	10.60 (173.70)
LL47-	1-1/4 (35)	6.45 (163.83)	2.30 (58.42)	3.05 (77.47)	1.80 (45.72)	5.00 (127.00)	18.60 (304.80)
LL57-	1-1/2 (41)	7.90 (200.66)	2.60 (66.04)	3.80 (96.52)	2.05 (52.07)	5.45 (138.43)	26.40 (432.62)
LL67-	2 (53)	8.30 (210.82)	3.20 (81.28)	4.25 (107.95)	2.45 (62.23)	6.40 (162.56)	51.00 (835.74)
LL777-	2-1/2 (63)	10.55 (267.97)	3.65 (92.71)	5.80 (147.32)	3.60 (91.44)	8.40 (213.36)	102.00 (1671.48)
LL87-	3 (78)	10.55 (267.97)	4.40 (111.76)	5.80 (147.32)	3.60 (91.44)	8.40 (213.36)	132.00 (2163.09)
LL97-	3-1/2 (91)	12.85 (326.39)	4.90 (124.46)	7.03 (178.56)	4.55 (115.57)	10.25 (260.35)	210.00 (3441.28)
LL107-	4 (103)	12.85 (326.39)	5.40 (137.16)	7.03 (178.56)	4.55 (115.57)	10.25 (260.35)	243.00 (3982.06)

LL Mark 9 Aluminum Conduit Bodies with Covers

Cat. No.	Hub Size in. (mm)	Dimensions in. (mm)*					Vol. Cap. (cu.in./cu.cm)
		A	B	C	D	E	
LL19-	1/2 (16)	4.59 (116.68)	1.38 (34.93)	2.13 (53.98)	1.19 (30.16)	3.31 (84.14)	—
LL29-	3/4 (21)	5.25 (133.35)	1.63 (41.28)	2.38 (60.33)	1.38 (34.93)	3.94 (100.01)	—
LL39-	1 (27)	6.09 (154.78)	1.88 (47.63)	2.63 (66.68)	1.50 (38.10)	4.56 (115.89)	—
LL49-	1-1/4 (35)	7.03 (178.59)	2.50 (63.50)	3.09 (78.58)	1.94 (49.21)	5.31 (134.94)	—
LL59-	1-1/2 (41)	7.75 (196.85)	2.75 (69.85)	3.44 (87.31)	2.25 (57.15)	6.00 (152.40)	—
LL69-	2 (53)	10.03 (254.79)	3.44 (87.31)	4.13 (104.78)	2.88 (73.03)	8.06 (204.79)	—
LL789-	2-1/2 (63)	13.94 (354.01)	4.44 (112.71)	6.69 (169.86)	4.25 (107.95)	10.88 (276.23)	—
LL889-	3 (78)	13.94 (354.01)	4.81 (122.24)	6.69 (169.93)	4.25 (107.95)	10.88 (276.35)	—
LL989-	3-1/2 (91)	16.88 (428.63)	5.69 (144.46)	8.13 (206.38)	5.44 (138.11)	13.44 (341.31)	—
LL1089-	4 (103)	16.88 (428.63)	5.94 (150.81)	8.13 (206.38)	5.44 (138.11)	13.44 (341.31)	—

LL Form 8 Ferrous Conduit Bodies with Covers

Cat. No.	Hub Size in. (mm)	Dimensions in. (mm)*					Vol. Cap. (cu.in./cu.cm)
		A	B	C	D	E	
LL18-	1/2 (16)	4.94 (125.41)	1.44 (36.51)	2.16 (54.77)	1.00 (25.40)	3.31 (84.14)	4.90 (80.30)
LL28-	3/4 (21)	5.56 (141.29)	1.69 (42.86)	2.31 (58.74)	1.19 (30.16)	3.94 (100.01)	8.00 (131.10)
LL38-	1 (27)	6.47 (164.31)	1.94 (49.21)	2.63 (66.68)	1.38 (34.93)	4.56 (115.89)	13.00 (213.03)
LL448-	1-1/4 (35)	7.53 (191.29)	2.38 (60.33)	3.16 (80.17)	1.75 (44.45)	5.31 (134.94)	23.50 (385.10)
LL58-	1-1/2 (41)	9.13 (231.78)	2.78 (70.64)	4.00 (101.60)	2.13 (53.98)	6.50 (165.10)	45.00 (737.42)
LL68-	2 (53)	11.00 (279.40)	3.56 (90.49)	5.00 (127.00)	3.00 (76.20)	8.56 (217.49)	88.00 (1442.06)
LL78-	2-1/2 (63)	13.94 (354.01)	4.44 (112.71)	6.69 (169.86)	4.25 (107.95)	10.88 (276.23)	110.00 (1802.58)
LL888-	3 (78)	13.94 (354.01)	4.81 (122.24)	6.69 (169.86)	4.25 (107.95)	10.88 (276.23)	110.00 (1802.58)

Metric size designator (ANSI C80.1-1994). * Dimensions shown are for uncoated conduit bodies.

LL Form 7 Aluminum Conduit Bodies with Covers

Cat. No.	Hub Size in. (mm)	Dimensions in. (mm)*					Vol. Cap. (cu.in./cu.cm)
		A	B	C	D	E	
LL17SA-	1/2 (16)	4.60 (116.84)	1.40 (35.56)	1.45 (36.83)	0.95 (24.13)	3.20 (81.28)	4.00 (65.55)
LL27SA-	3/4 (21)	5.25 (133.35)	1.60 (40.64)	1.65 (41.91)	1.15 (29.21)	3.80 (96.52)	6.60 (108.15)
LL37SA-	1 (27)	6.00 (152.40)	1.90 (48.26)	2.60 (66.04)	1.35 (34.29)	4.55 (115.57)	10.60 (173.70)
LL47SA-	1-1/4 (35)	6.45 (163.83)	2.30 (58.42)	3.05 (77.47)	1.80 (45.72)	5.00 (127.00)	18.60 (304.80)
LL57SA-	1-1/2 (41)	7.90 (200.66)	2.60 (66.04)	3.80 (96.52)	2.05 (52.07)	5.45 (138.43)	26.40 (432.62)
LL67SA-	2 (53)	8.30 (210.82)	3.20 (81.28)	4.25 (107.95)	2.45 (62.23)	6.40 (162.56)	51.00 (835.74)
LL777SA-	2-1/2 (63)	10.55 (267.97)	3.65 (92.71)	5.80 (147.32)	3.60 (91.44)	8.40 (213.36)	102.00 (1671.48)
LL87SA-	3 (78)	10.55 (267.97)	4.40 (111.76)	5.80 (147.32)	3.60 (91.44)	8.40 (213.36)	132.00 (2163.09)
LL97SA-	3-1/2 (91)	12.85 (326.39)	4.90 (124.46)	7.03 (178.56)	4.55 (115.57)	10.25 (260.35)	210.00 (3441.28)
LL107SA-	4 (103)	12.85 (326.39)	5.40 (137.16)	7.03 (178.56)	4.55 (115.57)	10.25 (260.35)	243.00 (3982.06)

Ordinary Location Fittings

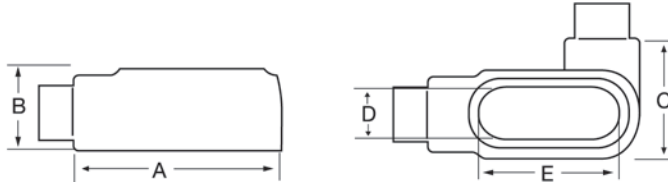

LR Form 7 Ferrous Conduit Bodies with Covers

Cat. No.	Hub Size in. (mm)	Dimensions in. (mm)*					Vol. Cap. (cu.in./cu.cm)
		A	B	C	D	E	
LR17-	1/2 (16)	4.60 (116.84)	1.40 (35.56)	1.45 (36.83)	0.95 (24.13)	3.20 (81.28)	4.00 (65.55)
LR27-	3/4 (21)	5.25 (133.35)	1.60 (40.64)	1.65 (41.91)	1.15 (29.21)	3.80 (96.52)	6.60 (108.15)
LR37-	1 (27)	6.00 (152.40)	1.90 (48.26)	2.60 (66.04)	1.35 (34.29)	4.55 (115.57)	10.60 (173.70)
LR47-	1-1/4 (35)	6.45 (163.83)	2.30 (58.42)	3.05 (77.47)	1.80 (45.72)	5.00 (127.00)	18.80 (308.08)
LR57-	1-1/2 (41)	7.90 (200.66)	2.60 (66.04)	3.80 (96.52)	2.05 (52.07)	5.45 (138.43)	26.40 (432.62)
LR67-	2 (53)	8.30 (210.82)	3.20 (81.28)	4.25 (107.95)	2.45 (62.23)	6.40 (162.56)	51.00 (835.74)
LR777-	2-1/2 (63)	10.55 (267.97)	3.65 (92.71)	5.80 (147.32)	3.60 (91.44)	8.40 (213.36)	102.00 (1671.48)
LR87-	3 (78)	10.55 (267.97)	4.40 (111.76)	5.80 (147.32)	3.60 (91.44)	8.40 (213.36)	132.00 (2163.09)
LR97-	3-1/2 (91)	12.85 (326.39)	4.90 (124.46)	7.03 (178.56)	4.55 (115.57)	10.25 (260.35)	210.00 (3441.28)
LR107-	4 (103)	12.85 (326.39)	5.40 (137.16)	7.03 (178.56)	4.55 (115.57)	10.25 (260.35)	243.00 (3982.06)

LR Mark 9 Aluminum Conduit Bodies with Covers

Cat. No.	Hub Size in. (mm)	Dimensions in. (mm)*					Vol. Cap. (cu.in./cu.cm)
		A	B	C	D	E	
LR19-	1/2 (16)	4.59 (116.68)	1.38 (34.93)	2.13 (53.98)	1.19 (30.16)	3.31 (84.14)	—
LR29-	3/4 (21)	5.25 (133.35)	1.63 (41.28)	2.38 (60.33)	1.38 (34.93)	3.94 (100.01)	—
LR39-	1 (27)	6.09 (154.78)	1.88 (47.63)	2.63 (66.68)	1.50 (38.10)	4.56 (115.89)	—
LR49-	1-1/4 (35)	7.03 (178.59)	2.50 (63.50)	3.09 (78.58)	1.94 (49.21)	5.31 (134.94)	—
LR59-	1-1/2 (41)	7.75 (196.85)	2.75 (69.85)	3.44 (87.31)	2.25 (57.15)	6.00 (152.40)	—
LR69-	2 (53)	10.03 (254.79)	3.44 (87.31)	4.13 (104.78)	2.88 (73.03)	8.06 (204.79)	—
LR789-	2-1/2 (63)	13.94 (354.01)	4.44 (112.71)	6.69 (169.86)	4.25 (107.95)	10.88 (276.23)	—
LR889-	3 (78)	13.94 (354.08)	4.81 (122.24)	6.69 (169.93)	4.25 (107.95)	10.88 (276.35)	—
LR989-	3-1/2 (91)	16.88 (428.63)	5.69 (144.46)	8.13 (206.38)	5.44 (138.11)	13.44 (341.31)	—
LR1089-	4 (103)	16.88 (428.63)	5.94 (150.81)	8.13 (206.38)	5.44 (138.11)	13.44 (341.31)	—

LR Form 8 Ferrous Conduit Bodies with Covers

Cat. No.	Hub Size in. (mm)	Dimensions in. (mm)*					Vol. Cap. (cu.in./cu.cm)
		A	B	C	D	E	
LR18-	1/2 (16)	4.94 (125.41)	1.44 (36.51)	2.16 (54.77)	1.00 (25.40)	3.31 (84.14)	4.90 (80.30)
LR28-	3/4 (21)	5.56 (141.29)	1.69 (42.86)	2.31 (58.74)	1.19 (30.16)	3.94 (100.01)	8.00 (131.10)
LR38-	1 (27)	6.47 (164.31)	1.94 (49.21)	2.63 (66.68)	1.38 (34.93)	4.56 (115.89)	13.00 (213.03)
LR448-	1-1/4 (35)	7.53 (191.29)	2.38 (60.33)	3.16 (80.17)	1.75 (44.45)	5.31 (134.94)	23.50 (385.10)
LR58-	1-1/2 (41)	9.13 (231.78)	2.78 (70.64)	4.00 (101.60)	2.13 (53.98)	6.50 (165.10)	45.00 (737.42)
LR68-	2 (53)	11.00 (279.40)	3.56 (90.49)	5.00 (127.00)	3.00 (76.20)	8.56 (217.49)	88.00 (1442.06)
LR78-	2-1/2 (63)	13.94 (354.01)	4.44 (112.71)	6.69 (169.86)	4.25 (107.95)	10.88 (276.23)	110.00 (1802.58)
LR888-	3 (78)	13.94 (354.01)	4.81 (122.24)	6.69 (169.86)	4.25 (107.95)	10.88 (276.23)	110.00 (1802.58)

Metric size designator (ANSI C80.1-1994). * Dimensions shown are for uncoated conduit bodies.

LR Form 7 Aluminum Conduit Bodies with Covers

Cat. No.	Hub Size in. (mm)	Dimensions in. (mm)*					Vol. Cap. (cu.in./cu.cm)
		A	B	C	D	E	
LR17SA-	1/2 (16)	4.60 (116.84)	1.40 (35.56)	1.45 (36.83)	0.95 (24.13)	3.20 (81.28)	4.00 (65.55)
LR27SA-	3/4 (21)	5.25 (133.35)	1.60 (40.64)	1.65 (41.91)	1.15 (29.21)	3.80 (96.52)	6.60 (108.15)
LR37SA-	1 (27)	6.00 (152.40)	1.90 (48.26)	2.60 (66.04)	1.35 (34.29)	4.55 (115.57)	10.60 (173.70)
LR47SA-	1-1/4 (35)	6.45 (163.83)	2.30 (58.42)	3.05 (77.47)	1.80 (45.72)	5.00 (127.00)	18.80 (308.08)
LR57SA-	1-1/2 (41)	7.90 (200.66)	2.60 (66.04)	3.80 (96.52)	2.05 (52.07)	5.45 (138.43)	26.40 (432.62)
LR67SA-	2 (53)	8.30 (210.82)	3.20 (81.28)	4.25 (107.95)	2.45 (62.23)	6.40 (162.56)	51.00 (835.74)
LR777SA-	2-1/2 (63)	10.55 (267.97)	3.65 (92.71)	5.80 (147.32)	3.60 (91.44)	8.40 (213.36)	102.00 (1671.48)
LR87SA-	3 (78)	10.55 (267.97)	4.40 (111.76)	5.80 (147.32)	3.60 (91.44)	8.40 (213.36)	132.00 (2163.09)
LR97SA-	3-1/2 (91)	12.85 (326.39)	4.90 (124.46)	7.03 (178.56)	4.55 (115.57)	10.25 (260.35)	210.00 (3441.28)
LR107SA-	4 (103)	12.85 (326.39)	5.40 (137.16)	7.03 (178.56)	4.55 (115.57)	10.25 (260.35)	243.00 (3982.06)

Ordinary Location Fittings

T

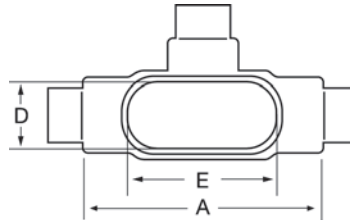
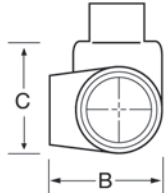

T Form 7 Ferrous Conduit Bodies with Covers

Cat. No.	Hub Size in. (mm)	Dimensions in. (mm)*					Vol. Cap. (cu.in./cu.cm)
		A	B	C	D	E	
T17-	1/2 (16)	5.60 (142.24)	1.80 (45.72)	2.35 (59.69)	0.95 (24.13)	3.20 (81.28)	6.00 (98.32)
T27-	3/4 (21)	6.20 (157.48)	2.00 (50.80)	2.60 (66.04)	1.15 (29.21)	3.80 (96.52)	9.10 (149.12)
T37-	1 (27)	7.35 (186.69)	2.30 (58.42)	3.10 (78.74)	1.35 (34.29)	4.55 (115.57)	16.90 (276.94)
T47-	1-1/4 (35)	7.30 (185.42)	2.30 (58.42)	3.05 (77.47)	1.80 (45.72)	5.00 (127.00)	19.30 (316.27)
T57-	1-1/2 (41)	8.60 (218.44)	2.60 (66.04)	3.80 (96.52)	2.05 (52.07)	5.45 (138.43)	27.50 (450.64)
T67-	2 (53)	9.50 (241.30)	3.20 (81.28)	4.25 (107.95)	2.45 (62.23)	6.40 (162.56)	50.00 (819.35)
T77-	2-1/2 (63)	12.10 (307.34)	3.65 (92.71)	5.80 (147.32)	3.60 (91.44)	8.40 (213.36)	102.00 (1671.48)
T87-	3 (78)	12.10 (307.34)	4.40 (111.76)	5.80 (147.32)	3.60 (91.44)	8.40 (213.36)	132.00 (2163.09)
T97-	3-1/2 (91)	14.65 (372.11)	4.90 (124.46)	7.05 (179.07)	4.55 (115.57)	10.25 (260.35)	210.00 (3441.28)
T107-	4 (103)	14.65 (372.11)	5.40 (137.16)	7.05 (179.07)	4.55 (115.57)	10.25 (260.35)	243.00 (3982.06)

T Mark 9 Aluminum Conduit Bodies with Covers

Cat. No.	Hub Size in. (mm)	Dimensions in. (mm)*					Vol. Cap. (cu.in./cu.cm)
		A	B	C	D	E	
T19-	1/2 (16)	5.00 (127.00)	1.38 (34.93)	2.13 (53.98)	1.19 (30.16)	3.31 (84.14)	—
T29-	3/4 (21)	5.69 (144.46)	1.63 (41.28)	2.38 (60.33)	1.38 (34.93)	3.94 (100.01)	—
T39-	1 (27)	6.59 (167.48)	1.88 (47.63)	2.63 (66.68)	1.50 (38.10)	4.56 (115.89)	—
T49-	1-1/4 (35)	7.50 (190.50)	2.50 (63.50)	3.09 (78.58)	1.94 (49.21)	5.31 (134.94)	—
T59-	1-1/2 (41)	8.25 (209.55)	2.75 (69.85)	3.44 (87.31)	2.25 (57.15)	6.00 (152.40)	—
T69-	2 (53)	10.50 (266.70)	3.44 (87.31)	4.13 (104.78)	2.88 (73.03)	8.06 (204.79)	—
T789-	2-1/2 (63)	15.63 (396.88)	4.44 (112.71)	6.69 (169.86)	4.25 (107.95)	10.88 (276.23)	—
T889-	3 (78)	15.63 (396.88)	4.81 (122.24)	6.69 (169.86)	4.25 (107.95)	10.88 (276.23)	—
T989-	3-1/2 (91)	18.75 (476.25)	5.69 (144.46)	8.13 (206.38)	5.44 (138.11)	13.44 (341.31)	—
T1089-	4 (103)	18.75 (476.25)	5.94 (150.81)	8.13 (206.38)	5.44 (138.11)	13.44 (341.31)	—

T Form 8 Ferrous Conduit Bodies with Covers

Cat. No.	Hub Size in. (mm)	Dimensions in. (mm)*					Vol. Cap. (cu.in./cu.cm)
		A	B	C	D	E	
T18-	1/2 (16)	5.69 (144.46)	1.75 (44.45)	2.16 (54.77)	1.00 (25.40)	3.31 (84.14)	6.00 (98.32)
T28-	3/4 (21)	6.28 (159.54)	2.00 (50.80)	2.31 (58.74)	1.19 (30.16)	3.94 (100.01)	9.00 (147.48)
T38-	1 (27)	7.31 (185.74)	2.25 (57.15)	2.63 (66.68)	1.38 (34.93)	4.56 (115.89)	15.00 (245.81)
T448-	1-1/4 (35)	8.50 (215.90)	2.63 (66.68)	3.16 (80.17)	1.75 (44.45)	5.31 (134.94)	24.00 (393.29)
T58-	1-1/2 (41)	10.38 (263.53)	2.78 (70.64)	4.00 (101.60)	2.13 (53.98)	6.50 (165.10)	46.50 (762.00)
T68-	2 (53)	12.25 (311.15)	3.56 (90.49)	5.00 (127.00)	3.00 (76.20)	8.56 (217.49)	88.00 (1442.06)
T78-	2-1/2 (63)	15.63 (396.88)	4.44 (112.71)	6.69 (169.86)	4.25 (107.95)	10.88 (276.23)	110.00 (1802.58)
T88-	3 (78)	15.63 (396.88)	4.81 (122.24)	6.69 (169.86)	4.25 (107.95)	10.88 (276.23)	110.00 (1802.58)

Metric size designator (ANSI C80.1-1994). * Dimensions shown are for uncoated conduit bodies.

T Form 7 Aluminum Conduit Bodies with Covers

Cat. No.	Hub Size in. (mm)	Dimensions in. (mm)*					Vol. Cap. (cu.in./cu.cm)
		A	B	C	D	E	
T17SA-	1/2 (16)	5.60 (142.24)	1.80 (45.72)	2.35 (59.69)	0.95 (24.13)	3.20 (81.28)	6.00 (98.32)
T27SA-	3/4 (21)	6.20 (157.48)	2.00 (50.80)	2.60 (66.04)	1.15 (29.21)	3.80 (96.52)	9.10 (149.12)
T37SA-	1 (27)	7.35 (186.69)	2.30 (58.42)	3.10 (78.74)	1.35 (34.29)	4.55 (115.57)	16.90 (276.94)
T47SA-	1-1/4 (35)	7.30 (185.42)	2.30 (58.42)	3.05 (77.47)	1.80 (45.72)	5.00 (127.00)	19.30 (316.27)
T57SA-	1-1/2 (41)	8.60 (218.44)	2.60 (66.04)	3.80 (96.52)	2.05 (52.07)	5.45 (138.43)	27.50 (450.64)
T67SA-	2 (53)	9.50 (241.30)	3.20 (81.28)	4.25 (107.95)	2.45 (62.23)	6.40 (162.56)	50.00 (819.35)
T77SA-	2-1/2 (63)	12.10 (307.34)	3.65 (92.71)	5.80 (147.32)	3.60 (91.44)	8.40 (213.36)	102.00 (1671.48)
T87SA-	3 (78)	12.10 (307.34)	4.40 (111.76)	5.80 (147.32)	3.60 (91.44)	8.40 (213.36)	132.00 (2163.09)
T97SA-	3-1/2 (91)	14.65 (372.11)	4.90 (124.46)	7.05 (179.07)	4.55 (115.57)	10.25 (260.35)	210.00 (3441.28)
T107SA-	4 (103)	14.65 (372.11)	5.40 (137.16)	7.05 (179.07)	4.55 (115.57)	10.25 (260.35)	243.00 (3982.06)

Ordinary Location Fittings

TB

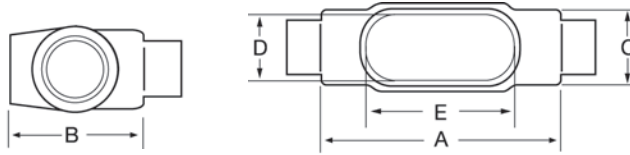

TB Form 7 Ferrous Conduit Bodies with Covers

Cat. No.	Hub Size in. (mm)	Dimensions in. (mm)*					Vol. Cap. (cu.in./cu.cm)
		A	B	C	D	E	
TB17_-	1/2 (16)	5.60 (142.24)	2.06 (52.32)	1.63 (41.40)	0.95 (24.13)	3.20 (81.28)	6.00 (98.32)
TB27_-	3/4 (21)	6.20 (157.48)	2.31 (58.67)	1.81 (45.97)	1.15 (29.21)	3.80 (96.52)	9.10 (149.12)
TB37_-	1 (27)	7.35 (186.69)	2.50 (63.50)	2.31 (58.67)	1.35 (34.29)	4.55 (115.57)	16.90 (276.94)
TB47_-	1-1/4 (35)	7.30 (185.42)	3.19 (81.03)	2.25 (57.15)	1.80 (45.72)	5.00 (127.00)	19.30 (316.27)
TB57_-	1-1/2 (41)	8.60 (218.44)	3.91 (99.31)	2.42 (61.47)	2.05 (52.07)	5.45 (138.43)	27.50 (450.64)
TB67_-	2 (53)	9.50 (241.30)	4.50 (114.30)	3.06 (77.72)	2.45 (62.23)	6.40 (162.56)	52.80 (865.24)

TB Mark 9 Aluminum Conduit Bodies with Covers

Cat. No.	Hub Size in. (mm)	Dimensions in. (mm)*					Vol. Cap. (cu.in./cu.cm)
		A	B	C	D	E	
TB19_-	1/2 (16)	5.00 (127.00)	2.13 (53.98)	1.38 (34.93)	1.19 (30.16)	3.31 (84.14)	—
TB29_-	3/4 (21)	5.69 (144.46)	2.41 (61.12)	1.56 (39.69)	1.38 (34.93)	3.94 (100.01)	—
TB39_-	1 (27)	6.59 (167.48)	2.84 (72.23)	1.75 (44.45)	1.50 (38.10)	4.56 (115.89)	—
TB49_-	1-1/4 (35)	7.50 (190.50)	3.47 (88.11)	2.19 (55.56)	1.94 (49.21)	5.31 (134.94)	—

TB Form 8 Ferrous Conduit Bodies with Covers

Cat. No.	Hub Size in. (mm)	Dimensions in. (mm)*					Vol. Cap. (cu.in./cu.cm)
		A	B	C	D	E	
TB18_-	1/2 (16)	5.69 (144.46)	2.63 (66.68)	1.38 (34.93)	1.00 (25.40)	3.31 (84.14)	6.00 (98.32)
TB28_-	3/4 (21)	6.28 (159.54)	2.88 (73.03)	1.19 (30.16)	1.19 (30.16)	3.94 (100.01)	9.00 (147.48)
TB38_-	1 (27)	7.31 (185.74)	3.25 (82.55)	1.75 (44.45)	1.38 (34.93)	4.56 (115.89)	15.00 (245.81)
TB448_-	1-1/4 (35)	8.50 (215.90)	3.31 (84.14)	2.19 (55.56)	1.75 (44.45)	5.31 (134.94)	24.00 (393.29)
TB58_-	1-1/2 (41)	10.38 (263.53)	3.69 (93.66)	2.75 (69.85)	2.13 (53.98)	6.50 (165.10)	46.50 (762.00)
TB68_-	2 (53)	12.25 (311.15)	4.25 (107.95)	3.75 (95.25)	3.00 (76.20)	8.56 (217.49)	88.00 (1442.06)

TB Form 7 Aluminum Conduit Bodies with Covers

Cat. No.	Hub Size in. (mm)	Dimensions in. (mm)*					Vol. Cap. (cu.in./cu.cm)
		A	B	C	D	E	
TB17SA_-	1/2 (16)	5.60 (142.24)	2.06 (52.32)	1.63 (41.40)	0.95 (24.13)	3.20 (81.28)	6.00 (98.32)
TB27SA_-	3/4 (21)	6.20 (157.48)	2.31 (58.67)	1.81 (45.97)	1.15 (29.21)	3.80 (96.52)	9.10 (149.12)
TB37SA_-	1 (27)	7.35 (186.69)	2.50 (63.50)	2.31 (58.67)	1.35 (34.29)	4.55 (115.57)	16.90 (276.94)
TB47SA_-	1-1/4 (35)	7.30 (185.42)	3.19 (81.03)	2.25 (57.15)	1.80 (45.72)	5.00 (127.00)	19.30 (316.27)
TB57SA_-	1-1/2 (41)	8.60 (218.44)	3.91 (99.31)	2.42 (61.47)	2.05 (52.07)	5.45 (138.43)	27.50 (450.64)
TB67SA_-	2 (53)	9.50 (241.30)	4.50 (114.30)	3.06 (77.72)	2.45 (62.23)	6.40 (162.56)	52.80 (865.24)

Metric size designator (ANSI C80.1-1994). * Dimensions shown are for uncoated conduit bodies.

**L Form 7 Ferrous Conduit Bodies with Covers

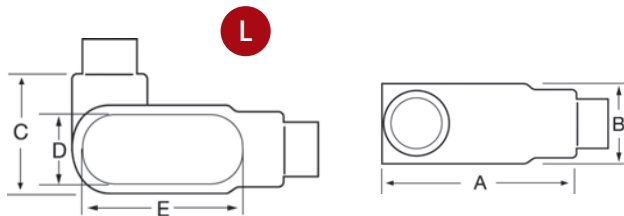

Metric size designator (ANSI C80.1-1994).
 *Dimensions shown are for uncoated conduit bodies.
 ** Not CSA Certified.

Cat. No.	Hub Size in. (mm)	Dimensions in. (mm)*					Vol. Cap. (cu.in./cu.cm)
		A	B	C	D	E	
L17_-	1/2 (16)	4.60 (116.84)	1.40 (35.56)	1.45 (36.83)	0.95 (24.13)	3.20 (81.28)	—
L27_-	3/4 (21)	5.25 (133.35)	1.60 (40.64)	1.65 (41.91)	1.15 (29.21)	3.80 (96.52)	—
L37_-	1 (27)	6.00 (152.40)	1.90 (48.26)	2.60 (66.04)	1.35 (34.29)	4.55 (115.57)	—
L47_-	1-1/4 (35)	6.45 (163.83)	2.30 (58.42)	3.05 (77.47)	1.80 (45.72)	5.00 (127.00)	—
L57_-	1-1/2 (41)	7.90 (200.66)	2.60 (66.04)	3.80 (96.52)	2.05 (52.07)	5.45 (138.43)	—
L67_-	2 (53)	8.30 (210.82)	3.20 (81.28)	4.25 (107.95)	2.45 (62.23)	6.40 (162.56)	—

Ordinary Location Fittings

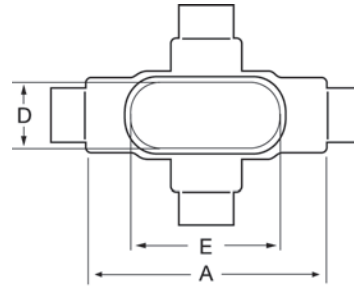
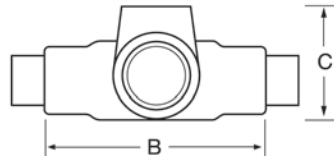

X Form 7 Ferrous Conduit Bodies with Covers

Cat. No.	Hub Size in. (mm)	Dimensions in. (mm)*					Vol. Cap. (cu.in./cu.cm)
		A	B	C	D	E	
X17-	1/2 (16)	5.60 (142.24)	1.80 (45.72)	3.05 (77.47)	0.95 (24.13)	3.20 (81.28)	6.00 (98.32)
X27-	3/4 (21)	6.20 (157.48)	2.00 (50.80)	3.30 (83.82)	1.15 (29.21)	3.80 (96.52)	9.10 (149.12)
X37-	1 (27)	7.35 (186.69)	2.30 (58.42)	3.80 (96.52)	1.35 (34.29)	4.55 (115.57)	16.90 (276.94)
X47-	1-1/4 (35)	7.30 (185.42)	2.30 (58.42)	3.85 (97.79)	1.80 (45.72)	5.00 (127.00)	19.30 (316.27)
X57-	1-1/2 (41)	8.60 (218.44)	2.60 (66.04)	5.05 (128.27)	2.05 (52.07)	5.45 (138.43)	27.50 (450.64)
X67-	2 (53)	9.50 (241.30)	3.20 (81.28)	5.45 (138.43)	2.45 (62.23)	6.40 (162.56)	52.80 (865.24)

X Mark 9 Aluminum Conduit Bodies with Covers

Cat. No.	Hub Size in. (mm)	Dimensions in. (mm)*					Vol. Cap. (cu.in./cu.cm)
		A	B	C	D	E	
X19-	1/2 (16)	5.69 (144.46)	2.91 (73.82)	1.75 (44.45)	1.00 (25.40)	3.31 (84.14)	—
X29-	3/4 (21)	6.28 (159.54)	3.06 (77.79)	2.00 (50.80)	1.19 (30.16)	3.94 (100.01)	—
X39-	1 (27)	7.31 (185.74)	3.50 (88.90)	2.25 (57.15)	1.38 (34.93)	4.56 (115.89)	—

X Form 8 Ferrous Conduit Bodies with Covers

Cat. No.	Hub Size in. (mm)	Dimensions in. (mm)*					Vol. Cap. (cu.in./cu.cm)
		A	B	C	D	E	
X18-	1/2 (16)	5.69 (144.46)	1.75 (44.45)	2.91 (73.82)	1.00 (25.40)	3.31 (84.14)	6.00 (98.32)
X28-	3/4 (21)	6.28 (159.54)	2.00 (50.80)	3.06 (77.79)	1.38 (34.93)	3.94 (100.01)	9.00 (147.48)
X38-	1 (27)	7.31 (185.74)	2.25 (57.15)	3.50 (88.90)	1.38 (34.93)	4.56 (115.89)	15.00 (245.81)
X448-	1-1/4 (35)	8.50 (215.90)	2.63 (66.68)	4.13 (104.78)	1.75 (44.45)	5.31 (134.94)	24.00 (393.29)
X58-	1-1/2 (41)	10.38 (263.53)	2.47 (62.71)	5.25 (133.35)	2.13 (53.98)	6.50 (165.10)	46.50 (762.00)
X68-	2 (53)	12.25 (311.15)	3.56 (90.49)	6.25 (158.75)	3.00 (76.20)	8.56 (217.49)	88.00 (1442.06)

X Form 7 Aluminum Conduit Bodies with Covers

Cat. No.	Hub Size in. (mm)*	Dimensions in. (mm)*					Vol. Cap. (cu.in./cu.cm)
		A	B	C	D	E	
X17SA-	1/2 (16)	5.60 (142.24)	1.80 (45.72)	3.05 (77.47)	0.95 (24.13)	3.20 (81.28)	6.00 (98.32)
X27SA-	3/4 (21)	6.20 (157.48)	2.00 (50.80)	3.30 (83.82)	1.15 (29.21)	3.80 (96.52)	9.10 (149.12)
X37SA-	1 (27)	7.35 (186.69)	2.30 (58.42)	3.80 (96.52)	1.35 (34.29)	4.55 (115.57)	16.90 (276.94)
X47SA-	1-1/4 (35)	7.30 (185.42)	2.30 (58.42)	3.85 (97.79)	1.80 (45.72)	5.00 (127.00)	19.30 (316.27)
X57SA-	1-1/2 (41)	8.60 (218.44)	2.60 (66.04)	5.05 (128.27)	2.05 (52.07)	5.45 (138.43)	27.50 (450.64)
X67SA-	2 (53)	9.50 (241.30)	3.20 (81.28)	5.45 (138.43)	2.45 (62.23)	6.40 (162.56)	52.80 (865.24)

Metric size designator (ANSI C80.1-1994). * Dimensions shown are for uncoated conduit bodies.

Ordinary Location Fittings

Unique Sealing Ring and Groove Design for Optimum Performance!

OCAL-BLUE™ Double-Coat and Stainless Steel Hubs

- Captive sealing ring won't buckle or slip during installation and provides a complete 360° seal — even when conduit isn't perpendicular to the enclosure
- Hexagonal/splined body and locknut enables fast and easy installation
- Insulated throat molded from 105°C-rated thermoplastic, UL94V0 flammability rated
- Sharper and deeper teeth provide a more penetrating bite for improved bonding to the enclosure
- Zinc or copper-free aluminum with a nominal 0.040 in. (40 mils) PVC coating bonded to exterior
- Pressure-sealing sleeves protect your connections



STG6-G

PVC-Coated Zinc Grounded Hub



HUB1-1/4-G

PVC-Coated Zinc Hub

Cat. No.	Colour
HUB-1	_ = space for colour identifier
	G = Grey
	W = White
	B = Blue
	R = Red

Custom colours also available - Std. min. quantities are required. Please contact your Regional Sales Office.

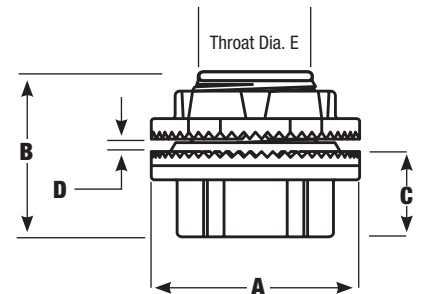

Knockout Hubs

PVC-Coated Zinc Hub Cat. No.	PVC-Coated Aluminum Hub Cat. No.	PVC-Coated Zinc Grounded Hub Cat. No.	Pipe Size in. (mm)	Dimensions (Uncoated Hub)				
				A (Overall Dia.)	B	C	D (Max. Panel Thickness)	E (Throat Dia.)
HUB1/2- <u> </u>	HUB1/2SA- <u> </u>	STG1- <u> </u>	1/2 (16)	1.44 (36.58)	1.56 (39.62)	0.88 (22.35)	0.19 (4.83)	0.59 (14.99)
HUB3/4- <u> </u>	HUB3/4SA- <u> </u>	STG2- <u> </u>	3/4 (21)	1.44 (36.58)	1.59 (40.39)	0.91 (23.11)	0.19 (4.83)	0.78 (19.81)
HUB1- <u> </u>	HUB1SA- <u> </u>	STG3- <u> </u>	1 (27)	2.00 (50.80)	1.81 (45.97)	1.06 (26.92)	0.25 (6.35)	1.00 (25.40)
HUB1-1/4- <u> </u>	HUB1-1/4SA- <u> </u>	STG4- <u> </u>	1-1/4 (35)	2.38 (60.45)	1.88 (47.75)	1.06 (26.92)	0.25 (6.35)	1.31 (33.35)
HUB1-1/2- <u> </u>	HUB1-1/2SA- <u> </u>	STG5- <u> </u>	1-1/2 (41)	2.75 (69.85)	1.88 (47.75)	1.06 (26.92)	0.25 (6.35)	1.53 (38.86)
HUB2- <u> </u>	HUB2SA- <u> </u>	STG6- <u> </u>	2 (53)	3.25 (82.55)	1.94 (49.28)	1.16 (29.46)	0.25 (6.35)	1.97 (50.04)
HUB2-1/2- <u> </u>	HUB2-1/2SA- <u> </u>	STG7- <u> </u>	2-1/2 (63)	3.75 (95.25)	2.56 (65.02)	1.56 (39.62)	0.25 (6.35)	2.41 (61.21)
HUB3- <u> </u>	HUB3SA- <u> </u>	STG8- <u> </u>	3 (78)	4.38 (111.25)	2.44 (61.98)	1.59 (40.39)	0.25 (6.35)	2.97 (75.44)
HUB3-1/2- <u> </u>	HUB3-1/2SA- <u> </u>	STG9- <u> </u>	3-1/2 (91)	5.00 (127.00)	2.72 (69.09)	1.63 (41.40)	0.25 (6.35)	3.41 (86.61)
HUB4- <u> </u>	HUB4SA- <u> </u>	STG10- <u> </u>	4 (103)	5.50 (139.70)	2.72 (69.09)	1.63 (41.40)	0.25 (6.35)	3.88 (98.55)
HUB5- <u> </u>	HUB5SA- <u> </u>	STG11- <u> </u>	5 (129)	6.88 (174.75)	3.03 (76.96)	1.94 (49.28)	0.25 (6.35)	4.94 (125.48)
HUB6- <u> </u>	HUB6SA- <u> </u>	STG12- <u> </u>	6 (155)	7.69 (195.33)	3.16 (80.26)	2.00 (50.80)	0.31 (7.87)	6.00 (152.40)

Ordinary Location Fittings

In Bulkhead and Through-Bulkhead Styles!



STTB2-G Bulkhead Fitting



STTTB2-G Through-Bulkhead Fitting

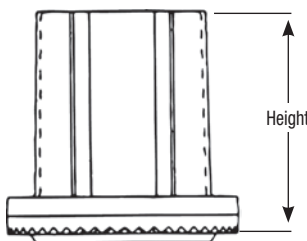
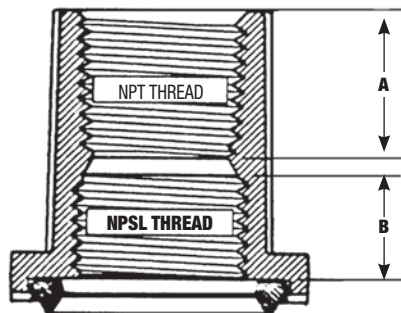
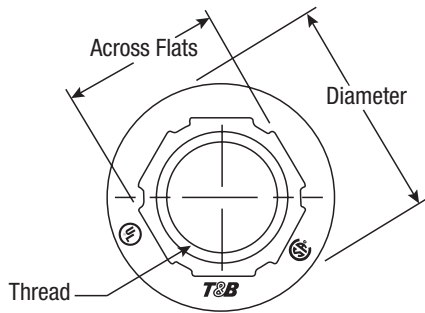

Ocal™ PVC-Coated Bulkhead Fittings

- Zinc body and locknut with thermoplastic insulating throat and nitrile sealing ring
- Nominal 0.040 in. (40 mils) PVC coating bonded to exterior
- Pressure-sealing sleeves protect your connections

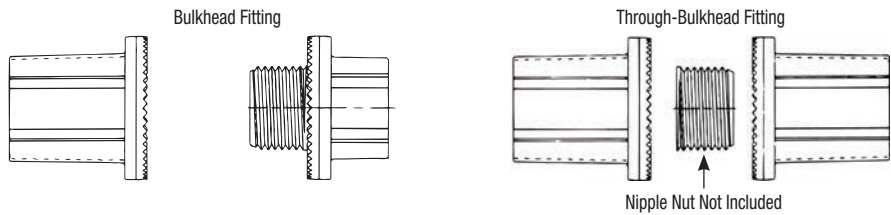

Bulkhead Fitting Cat. No.	Through-Bulkhead Fitting Cat. No.	Pipe Size in. (mm)	Thread	Height in. (mm)	Dia. in. (mm)	Across Flats in. (mm)	"A" in. (mm)	"B" in. (mm)
STTB1-	STTTB1-	1/2 (16)	1/2-14	1.41 (35.72)	1.44 (36.51)	1.00 (25.40)	0.75 (19.05)	0.50 (12.70)
STTB2-	STTTB2-	3/4 (21)	3/4-14	1.47 (37.31)	1.69 (42.86)	1.25 (31.75)	0.78 (19.84)	0.53 (13.49)
STTB3-	STTTB3-	1 (27)	1-11-1/2	1.69 (42.86)	2.00 (50.80)	1.53 (38.89)	0.91 (23.02)	0.59 (15.08)
STTB4-	STTTB4-	1-1/4 (35)	1-1/4-11-1/2	1.78 (45.24)	2.38 (60.33)	1.84 (46.83)	0.91 (23.02)	0.66 (16.67)
STTB5-	STTTB5-	1-1/2 (41)	1-1/2-11-1/2	1.81 (46.04)	2.75 (69.85)	1.13 (28.58)	0.91 (23.02)	0.66 (16.67)
STTB6-	STTTB6-	2 (53)	2-11-1/2	1.84 (46.83)	3.25 (82.55)	2.63 (66.68)	0.94 (23.81)	0.66 (16.67)
STTB7-	-	2-1/2 (63)	2-1/2-8	2.28 (57.94)	3.75 (95.25)	3.13 (79.38)	1.22 (30.96)	0.88 (22.23)
STTB8-	-	3 (78)	3-8	2.56 (65.09)	4.38 (111.13)	3.78 (96.04)	1.19 (30.16)	0.91 (23.02)
STTB9-	-	3-1/2 (91)	3-1/2-8	2.56 (65.09)	5.00 (127.00)	4.28 (108.74)	1.38 (34.93)	0.88 (22.23)
STTB10-	-	4 (103)	4-8	2.56 (65.09)	5.50 (139.70)	4.84 (123.03)	1.38 (34.93)	0.88 (22.23)
STTB11-	-	5 (129)	5-8	2.72 (69.06)	6.63 (168.28)	5.91 (150.02)	1.47 (37.31)	0.88 (22.23)
STTB12-	-	6 (155)	6-8	3.00 (76.20)	7.69 (195.26)	7.03 (178.58)	1.50 (38.10)	0.97 (24.61)

Metric size designator (ANSI C80.1-1994). Dimensions shown are for uncoated fittings.

Cat. No.	Colour
STTB1-	_ = space for colour identifier
	G = Grey
	W = White
	B = Blue

Custom colours also available - Std. min. quantities are required. Please contact your Regional Sales Office.

Ordinary Location Fittings

The Ultimate Liquidtight Solution for Corrosive Environments!

Ocal™ PVC-Coated Liquidtight Conduit Connectors

- Nominal 0.040 in. (40 mils) PVC coating bonded to exterior
- Pressure-sealing sleeves are designed to protect the connection
- Ocal™ uses only genuine T&B® liquidtight fittings to ensure quality installations

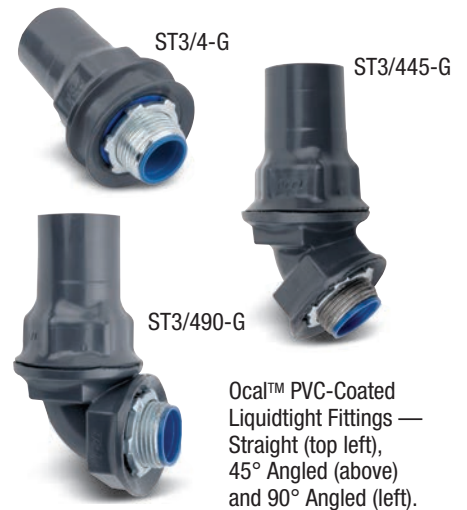

PVC-Coated Steel Straight Cat. No.	PVC-Coated Aluminum Straight Cat. No.	PVC-Coated Steel 45° Cat. No.	PVC-Coated Steel 90° Cat. No.	PVC-Coated Aluminum 90° Cat. No.	Pipe Size in. (mm)
ST3/8- <u> </u>	ST3/8SA- <u> </u>	ST3/845- <u> </u>	ST3/890- <u> </u>	ST3/890SA- <u> </u>	3/8 (10)
ST1/2- <u> </u>	ST1/2SA- <u> </u>	ST1/245- <u> </u>	ST1/290- <u> </u>	ST1/290SA- <u> </u>	1/2 (16)
ST3/4- <u> </u>	ST3/4SA- <u> </u>	ST3/445- <u> </u>	ST3/490- <u> </u>	ST3/490SA- <u> </u>	3/4 (21)
ST1- <u> </u>	ST1SA- <u> </u>	ST145- <u> </u>	ST190- <u> </u>	ST190SA- <u> </u>	1 (27)
ST1-1/4- <u> </u>	ST1-1/4SA- <u> </u>	ST1-1/445- <u> </u>	ST1-1/490- <u> </u>	ST1-1/490SA- <u> </u>	1-1/4 (35)
ST1-1/2- <u> </u>	ST1-1/2SA- <u> </u>	ST1-1/245- <u> </u>	ST1-1/290- <u> </u>	ST1-1/290SA- <u> </u>	1-1/2 (41)
ST2- <u> </u>	ST2SA- <u> </u>	ST245- <u> </u>	ST290- <u> </u>	ST290SA- <u> </u>	2 (53)
ST2-1/2- <u> </u>	ST2-1/2SA- <u> </u>	ST2-1/245- <u> </u>	ST2-1/290- <u> </u>	ST2-1/290SA- <u> </u>	2-1/2 (63)
ST3- <u> </u>	ST3SA- <u> </u>	ST345- <u> </u>	ST390- <u> </u>	ST390SA- <u> </u>	3 (78)
ST4- <u> </u>	ST4SA- <u> </u>	ST445- <u> </u>	ST490- <u> </u>	ST490SA- <u> </u>	4 (103)

Cat. No.	Material	Colour
ST3/4-	- Blank = Steel/Iron SA = Aluminum	- = space for colour identifier
		G = Grey
		W = White
		B = Blue
		R = Red

Custom colours also available - Std. min. quantities are required. Please contact your Regional Sales Office.

Ordinary Location Fittings

No Disassembly Required



- 1** Slide the fitting onto the conduit until it stops at the internal sliding bushing. Tighten and you're ready. No parts to reassemble!
- 2** With a wrench, tighten the gland nut to create a raintight seal around the conduit.
- 3** Thread the next length of conduit into the other end of the fitting and tighten. You're done!

Ocal™ PVC-Coated XJG Rigid Conduit Expansion Couplings

When you install a rigid expansion coupling in a long conduit run, you normally need three hands, two strong backs and lots of patience. Now you can relax.

With the no-hassle XJG Rigid Conduit Expansion Coupling, installation's just a few turns and you're done.

The XJG Rigid Conduit Expansion Coupling features innovations that provide convenience to the installer, saving time and money on the job. No disassembly is needed during installation, requiring fewer tools and less opportunity for lost pieces. It also features a true internal bonding jumper, eliminating the need for external jumpers, so there are fewer parts to buy and install.

If you need a fitting that can give and take without a lot of hassle, reach for the XJG Rigid Conduit Expansion Coupling. It's the latest breakthrough in the industry's leading line of conduit fittings.



8" Movement Coupling shown uncoated

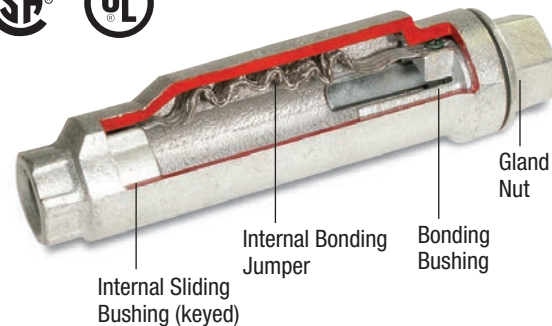

Coupling shown uncoated

Innovative Design Makes Installations Easier.

- No disassembly necessary to install
- Fast, simple and requires fewer steps
- True internal bonding jumper — no external grounding strap required
- Tamper-proof internal jumper protected from the environment
- Exceed code requirements for long conduit runs to permit linear movement
- Double coated with a nominal 0.002 in. (2 mils) blue urethane, on both the interior and exterior, before PVC coating is applied
- A minimum of 0.040 in. (40 mils) PVC Coating is bonded to the exterior
- Pressure sealing sleeve to seal the connection

Ordinary Location Fittings

Ocal™ PVC-Coated XJG Rigid Conduit Expansion Couplings (cont'd)

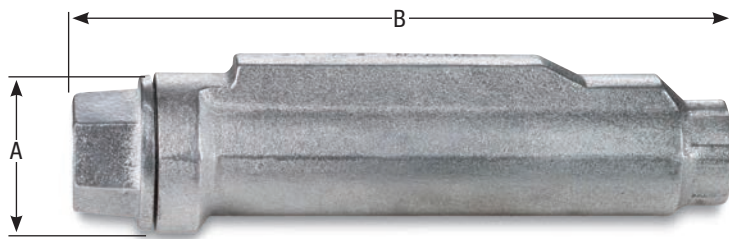

Coupling shown uncoated

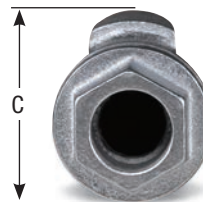

XJG24-G
4 in. Movement



Cat. No.	Pipe Size in. (mm)	Movement in. (mm)	A Diameter in. (mm)	B Length in. (mm)	C Height in. (mm)
XJG24-	3/4 (21)	4.00 (101.60)	2.43 (61.72)	10.00 (254.00)	2.75 (69.85)
XJG28-	3/4 (21)	8.00 (203.20)	2.43 (61.72)	14.00 (355.60)	2.75 (69.85)
XJG34-	1 (27)	4.00 (101.60)	2.67 (67.82)	10.00 (254.00)	2.99 (75.95)
XJG38-	1 (27)	8.00 (203.20)	2.67 (67.82)	14.00 (355.60)	2.99 (75.95)
XJG44-	1-1/4 (35)	4.00 (101.60)	3.36 (85.34)	10.56 (268.22)	3.68 (93.47)
XJG48-	1-1/4 (35)	8.00 (203.20)	3.36 (85.34)	14.56 (369.82)	3.68 (93.47)
XJG54-	1-1/2 (41)	4.00 (101.60)	3.36 (85.34)	10.56 (268.22)	3.68 (93.47)
XJG58-	1-1/2 (41)	8.00 (203.20)	3.36 (85.34)	14.56 (369.82)	3.68 (93.47)
XJG64-	2 (53)	4.00 (101.60)	3.86 (98.04)	11.25 (285.75)	4.18 (106.17)
XJG68-	2 (53)	8.00 (203.20)	3.86 (98.04)	15.25 (387.35)	4.18 (106.17)
XJG74-	2-1/2 (63)	4.00 (101.60)	4.96 (125.98)	12.12 (307.85)	5.25 (133.35)
XJG78-	2-1/2 (63)	8.00 (203.20)	4.96 (125.98)	16.12 (409.45)	5.25 (133.35)
XJG84-	3 (78)	4.00 (101.60)	4.96 (125.98)	12.12 (307.85)	5.25 (133.35)
XJG88-	3 (78)	8.00 (203.20)	4.96 (125.98)	16.12 (409.45)	5.25 (133.35)
XJG94-	3-1/2 (91)	4.00 (101.60)	6.37 (161.80)	12.87 (326.90)	6.75 (171.45)
XJG98-	3-1/2 (91)	8.00 (203.20)	6.37 (161.80)	16.87 (428.50)	6.75 (171.45)
XJG104-	4 (103)	4.00 (101.60)	6.37 (161.80)	12.87 (326.90)	6.75 (171.45)
XJG108-	4 (103)	8.00 (203.20)	6.37 (161.80)	16.87 (428.50)	6.75 (171.45)
XJG1208-	5 (129)	8.00 (203.20)	7.99 (161.80)	18.87 (479.30)	8.56 (217.42)

Metric size designator (ANSI C80.1-1994). Dimensions shown are for uncoated coupling.

Standard Materials / Finish

Body / Finish Ductiles iron with nominal
0.040 in. (40 mils) PVC
exterior coating

Internal Bonding Jumper Tinned copper braid

Cat. No.	Colour
XJG24-	_ = space for colour identifier
	G = Grey
	W = White
	B = Blue
	R = Red
Custom colours also available - Std. min. quantities are required. Please contact your Regional Sales Office.	

Ordinary Location Fittings

Variety of Styles Offers Versatility!

OCAL-BLUE™ Double-Coat FS and FD Series Device Boxes

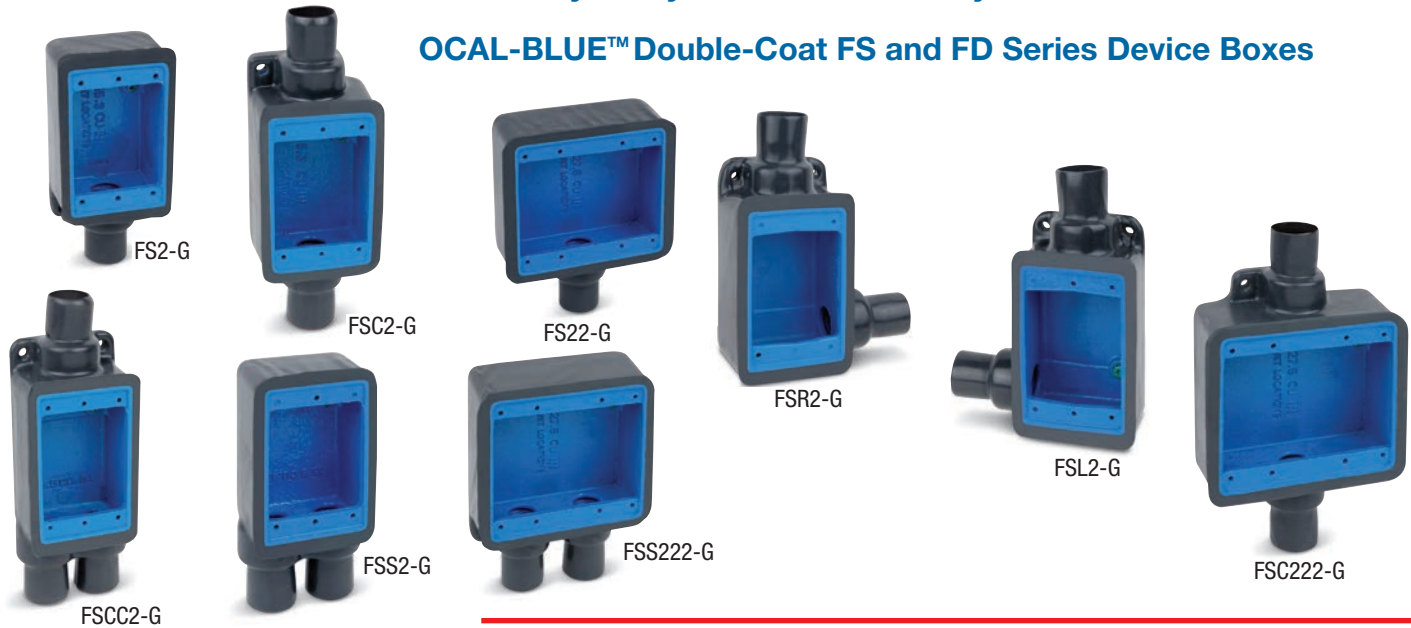

Install these boxes in conduit systems to accommodate wiring devices, act as pull boxes for conductors, provide openings to make splices and taps and provide access to conductors for maintenance and future system changes.

- Cast class 30 grey iron alloy boxes
- Coated with a nominal 0.002 in. (2 mils) blue urethane on both the interior and exterior before PVC coating is applied
- Nominal 0.040 in. (40 mils) PVC coating bonded to exterior
- PVC coating available in your choice of blue, white or grey
- Pressure sealing sleeves protect connections with conduit

Cat. No.	Colour
FS1-	_ = space for colour identifier
	G = Grey
	W = White
	B = Blue
Custom colours also available - Std. min. quantities are required. Please contact your Regional Sales Office.	

Dead End Cat. No.	Feed-Thru Cat. No.	Hub Right Cat. No.	Hub Left Cat. No.	Style	Pipe Size in. (mm)
Single Gang					
FS1- <u> </u>	FSC1- <u> </u>	FSR1- <u> </u>	FSL1- <u> </u>	Shallow	1/2 (16)
FS2- <u> </u>	FSC2- <u> </u>	FSR2- <u> </u>	FSL2- <u> </u>	Shallow	3/4 (21)
FS3- <u> </u>	FSC3- <u> </u>	—	—	Shallow	1 (27)
FD1- <u> </u>	FDC1- <u> </u>	FDR1- <u> </u>	FDL1- <u> </u>	Deep	1/2 (16)
FD2- <u> </u>	FDC2- <u> </u>	FDR2- <u> </u>	FDL2- <u> </u>	Deep	3/4 (21)
FD3- <u> </u>	FDC3- <u> </u>	—	—	Deep	1 (27)
—	FSCC2- <u> </u>	—	—	Shallow	3/4 (21)
—	FDCC2- <u> </u>	—	—	Deep	3/4 (21)
FSS2- <u> </u>	—	—	—	Shallow	3/4 (21)
FDD2- <u> </u>	—	—	—	Deep	3/4 (21)
Double Gang					
FS22- <u> </u>	—	—	—	Shallow	3/4 (21)
FD22- <u> </u>	—	—	—	Deep	3/4 (21)
FSS222- <u> </u>	—	—	—	Shallow	3/4 (21)
FDS222- <u> </u>	—	—	—	Deep	3/4 (21)
—	FSC222- <u> </u>	—	—	Shallow	3/4 (21)
—	FDCC222- <u> </u>	—	—	Deep	3/4 (21)

Metric size designator (ANSI C80.1-1994).

Ordinary Location Fittings

Designed for Use with Ocal™ FS and FD Series Boxes

OCAL-BLUE™ Double-Coat FS and FD Series Covers



DS23-G



DS21G-G



DS32G-G



DS100G-G



CFSTF-G

Cat. No.	Description	Material
Single Gang		
DS23- <u> </u>	Duplex Receptacle Cover	Steel
DS21G- <u> </u>	Round Flush Receptacle Cover	Iron
DS32G- <u> </u>	Toggle Switch Cover	Iron
DS100G- <u> </u>	Blank Cover	Aluminum
Single Gang — NEMA 3R Raintight when used with appropriate Ocal™ boxes		
CWPDR-FS- <u> </u>	Duplex Receptacle Cover — Box Mount — Horizontal	Aluminum
CFSDR- <u> </u>	Duplex Receptacle Cover — Box Mount — Vertical	Aluminum
CFSHG- <u> </u>	GFCI Receptacle Cover — Box Mount — Horizontal	Aluminum
CFSRG- <u> </u>	GFCI Receptacle Cover — Box Mount — Vertical	Aluminum
CFSTF- <u> </u>	Front Lever Switch Cover — Box Mount — NEMA 4	Aluminum
Double Gang		
S1002G- <u> </u>	Blank Cover	Iron
S322G- <u> </u>	2 Toggle Switch Cover	Iron
S232- <u> </u>	2 Duplex Receptacle Cover	Stamped Steel
S232GFI- <u> </u>	2 GFCI Receptacle Cover	Steel
Double Gang — NEMA 3R Raintight when used with appropriate Ocal™ boxes		
2CFST- <u> </u>	2 Plunger-Style Switch Cover	Aluminum

PVC-coated covers in other styles and materials are available upon request. Contact your Regional Sales Office for more information.



CFSDR-G



CFSRG-G



CFSHG-G



CWPDR-FS-G



S1002G-G



S322G-G

Cat. No.	Colour
DS23-	<u> </u> = space for colour identifier
	G = Grey
	W = White
	B = Blue
Custom colours also available - Std. min. quantities are required. Please contact your Regional Sales Office.	



S232GFI-G



S232-G



DS1282-G

Ordinary Location Fittings

Make 90° Bends While Allowing Straight Pulls!

OCAL-BLUE™ Double-Coat Pulling Elbows



LBD2200-G

LBD and LBH bodies are installed at 90° bends in rigid conduit to act as pull outlets for conductors that are stiff due to large size or type of insulation and to make 90° bends in conduit system while allowing straight wire pulls in either direction.

- Choose LBD Series for ordinary locations and LBH Series for hazardous locations
- Coated with a nominal 0.002 in. (2 mils) blue urethane on both interior and exterior
- Nominal 0.040 in. (40 mils) PVC coating bonded to exterior
- Pressure-sealing sleeves seal connections

Cat. No.	Colour
LBD1100-	_ = space for colour identifier
	G = Grey
	W = White
	B = Blue
Custom colours also available - Std. min. quantities are required. Please contact your Regional Sales Office.	

Ordinary LBD Series Cat. No.	Hazardous LBH Series Cat. No.	Pipe Size in. (mm)
LBD1100-	LBH10-	1/2 (16)
LBD2200-	LBH20-	3/4 (21)
LBD3300-	LBH30-	1 (27)
LBD4400-	LBH40-	1-1/4 (35)
LBD5500-	LBH50-	1-1/2 (41)
LBD6600-	LBH60-	2 (53)
LBD7700-	LBH70-	2-1/2 (63)
LBD8800-	LBH80-	3 (78)
LBD9900-	LBH90-	3-1/2 (91)
LBD10900-	LBH100-	4 (103)
LBD012-	—	5 (129)
LBD014-	—	6 (155)

Metric size designator (ANSI C80.1-1994).



BC3-G Mogul



BLB4-G Mogul



BUB3-G Mogul

OCAL-BLUE™ Double-Coat Mogul Fittings

Install mogul fittings in conduit systems to act as pull outlets for conductors that are stiff due to large size or type of installation, to provide the longer openings needed when pulling large conductors, to prevent sharp bends and kinks in large conductors or to provide more splicing space.

- Nominal 0.002 in. (2 mils) blue urethane on both interior and exterior
- Nominal 0.040 in. (40 mils) PVC coating bonded to exterior
- Pressure-sealing sleeves protect connections



BG48-G Replacement Cover

Cat. No.	Colour
BC3-	_ = space for colour identifier
	G = Grey
	W = White
	B = Blue
Custom colours also available - Std. min. quantities are required. Please contact your Regional Sales Office.	

Mogul Fitting with Cover and Gasket				Replacement Cover BG Cat. No.	Pipe Size in. (mm)
BC Cat. No.	BLB Cat. No.	BUB Cat. No.	BT Cat. No.		
BC3-	BLB3-	BUB3-	BT3-	BG48-	1 (27)
BC4-	BLB4-	BUB4-	BT4-	BG48-	1-1/4 (35)
BC5-	BLB5-	BUB5-	BT5-	BG68-	1-1/2 (41)
BC6-	BLB6-	BUB6-	BT6-	BG68-	2 (53)
BC7-	BLB7-	BUB7-	BT7-	BG88-	2-1/2 (63)
BC8-	BLB8-	BUB8-	BT8-	BG88-	3 (78)
BC9-	BLB9-	BUB9-	BT9-	BG98-	3-1/2 (91)
BC10-	BLB10-	BUB10-	BT10-	BG98-	4 (103)

Metric size designator (ANSI C80.1-1994).

Ordinary Location Fittings

Make 90° Bends in Limited Space!

OCAL-BLUE™ Double-Coat Service Entrance Elbows

LBY Series elbows are installed in conduit systems within hazardous areas to make 90° bends where space is limited, to act as pull outlets and to provide access to conductors for maintenance and future system changes.

- Nominal 0.002 in. (2 mils) blue urethane on both interior and exterior
- Nominal 0.040 in. (40 mils) PVC coating bonded to exterior
- Pressure-sealing sleeves protect connections



LBY25-G

Ordinary LBD Series Cat. No.	Pipe Size in. (mm)
LBY15- <u> </u>	1/2 (16)
LBY25- <u> </u>	3/4 (21)
LBY35- <u> </u>	1 (27)
LBY45- <u> </u>	1-1/4 (35)
LBY55- <u> </u>	1-1/2 (41)



LBY25-G

Cat. No.	Material	Colour
LBY15-	SA = Aluminum	- = space for colour identifier
		G = Grey
		W = White
		B = Blue

Custom colours also available - Std. min. quantities are required. Please contact your Regional Sales Office.

Metric size designator (ANSI C80.1-1994).

End or Change Directions in Conduit Runs

OCAL-BLUE™ Double-Coat Malleable Elbows

EL Series elbows are installed at the end of conduit runs, in a box or a fitting hub to change direction in threaded rigid conduit run by 45° or 90°, or when terminating at a box or fitting.

- Nominal 0.002 in. (2 mils) blue urethane on both interior and exterior
- Nominal 0.040 in. (40 mils) PVC coating bonded to exterior
- Pressure-sealing sleeves protect connections

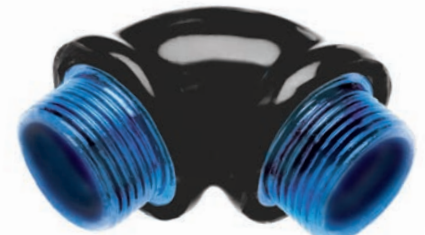

90° Male Cat. No.	90° Female Cat. No.	90° Male-Female Cat. No.	45° Female Cat. No.	Pipe Size in. (mm)
EL195- <u> </u>	EL19- <u> </u>	EL196- <u> </u>	EL1- <u> </u>	1/2 (16)
EL295- <u> </u>	EL29- <u> </u>	EL296- <u> </u>	EL2- <u> </u>	3/4 (21)
EL395- <u> </u>	EL39- <u> </u>	EL396- <u> </u>	EL3- <u> </u>	1 (27)
—	EL49- <u> </u>	EL496- <u> </u>	EL4- <u> </u>	1-1/4 (35)
—	EL59- <u> </u>	—	EL5- <u> </u>	1-1/2 (41)
—	EL69- <u> </u>	—	EL6- <u> </u>	2 (53)
—	EL79- <u> </u>	—	EL7- <u> </u>	2-1/2 (63)
—	—	—	EL8- <u> </u>	3 (78)
—	—	—	EL9- <u> </u>	3-1/2 (91)
—	—	—	EL10- <u> </u>	4 (103)

Cat. No.	Material	Colour
EL195-	SA = Aluminum	- = space for colour identifier
		G = Grey
		W = White
		B = Blue

Custom colours also available - Std. min. quantities are required. Please contact your Regional Sales Office.

Metric size designator (ANSI C80.1-1994).

Ordinary Location Fittings

Join Two Conduit Runs When Neither Can Rotate!

OCAL-BLUE™ Double-Coat Threaded Erickson® 3-Piece Couplings

- Malleable iron and steel or copper-free aluminum
- Nominal 0.002 in. (2 mils) blue urethane coating on both interior and exterior
- Nominal 0.040 in. (40 mils) PVC coating bonded to exterior
- Free fitting threads ensure easy assembly
- Provide rigid in-line coupling with high-quality grounding — won't loosen under vibration
- Suitable for concrete-tight applications

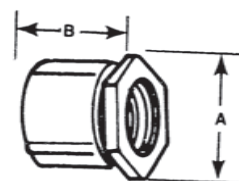

ERICSON3/4-G



ERICSON1-G



ERICSON3/4-G unassembled



Erickson® coupling before coating

Steel/ Malleable Iron Cat. No.	Copper Free Aluminum Cat. No.	Pipe Size in. (mm)	Dimensions in. (mm)	
			A	B
ERICSON1/2- <u> </u>	ERICSON1/2SA- <u> </u>	1/2 (16)	1.47 (37.34)	1.25 (31.75)
ERICSON3/4- <u> </u>	ERICSON3/4SA- <u> </u>	3/4 (21)	1.56 (39.62)	1.41 (35.81)
ERICSON1- <u> </u>	ERICSON1SA- <u> </u>	1 (27)	1.91 (48.51)	1.63 (41.40)
ERICSON1-1/4- <u> </u>	ERICSON1-1/4SA- <u> </u>	1-1/4 (35)	2.38 (60.45)	1.81 (45.97)
ERICSON1-1/2- <u> </u>	ERICSON1-1/2SA- <u> </u>	1-1/2 (41)	2.63 (66.80)	1.97 (50.04)
ERICSON2- <u> </u>	ERICSON2SA- <u> </u>	2 (53)	3.22 (81.79)	2.22 (56.39)
ERICSON2-1/2- <u> </u>	ERICSON2-1/2SA- <u> </u>	2-1/2 (63)	3.97 (100.84)	2.69 (68.33)
ERICSON3- <u> </u>	ERICSON3SA- <u> </u>	3 (78)	4.44 (112.78)	2.91 (73.91)
ERICSON3-1/2- <u> </u>	ERICSON3-1/2SA- <u> </u>	3-1/2 (91)	5.00 (127.00)	3.00 (76.20)
ERICSON4- <u> </u>	ERICSON4SA- <u> </u>	4 (103)	5.50 (139.70)	3.19 (81.03)
ERICSON5- <u> </u>	ERICSON5SA- <u> </u>	5 (129)	6.78 (172.21)	3.75 (95.25)
ERICSON6- <u> </u>	ERICSON6SA- <u> </u>	6 (155)	8.00 (203.20)	4.03 (102.36)

Metric size designator (ANSI C80.1-1994).

Standard Materials / Finish

Cat. No. ERICSON

Bushing & Case Malleable iron
 Ring Steel and malleable iron
 Finish Nominal 0.002 in. (2 mils) blue urethane interior
 and exterior coating with nominal
 0.040 in. (40 mils) PVC exterior coating

Cat. No. ERICSON_SA

Bushing & Case Copper-free aluminum
 Ring Copper-free aluminum
 Finish Nominal 0.002 in. (2 mils) blue urethane interior
 and exterior coating with nominal
 0.040 in. (40 mils) PVC exterior coating

Cat. No.	Size	Material	Colour
ERICSON	1/2	-	_ = space for colour identifier
		Blank = Steel SA = Aluminum	G = Grey W = White B = Blue
<i>Catalogue No. Example:</i> ERICSON2SA-B is 2 in. aluminum Erickson® coupling coated in blue PVC.			Custom colours also available - Std. min. quantities are required. Please contact your Regional Sales Office.

Ordinary Location Fittings

Easily Join Two Different Sizes of Conduit!

OCAL-BLUE™ Double-Coat Reducing Couplings

- Integral bushings in both ends prevent damage to wires
- Funnel-shaped interior guides wires from large to small conduit, making them easier to pull
- Nominal 0.002 in. (2 mils) blue urethane coating on both interior and exterior
- Nominal 0.040 in. (40 mils) PVC coating bonded to exterior
- Pressure-sealing sleeves protect connections

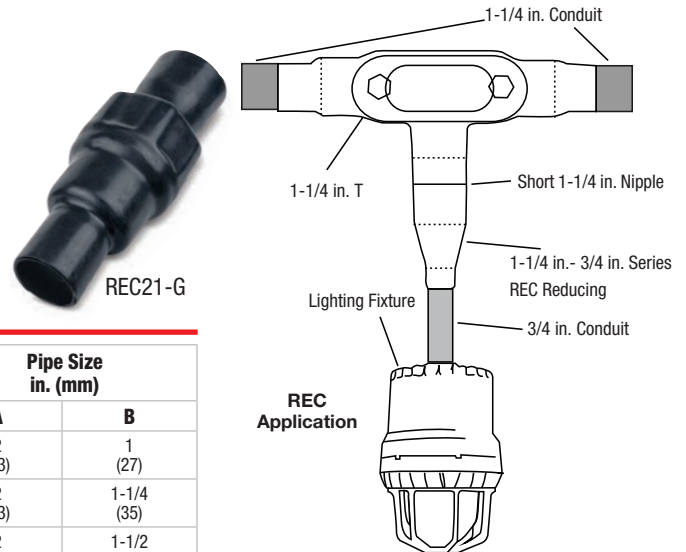

Cat. No.	Pipe Size in. (mm)	
	A	B
REC21-	3/4 (21)	1/2 (16)
REC31-	1 (27)	1/2 (16)
REC32-	1 (27)	3/4 (21)
REC42-	1-1/4 (35)	3/4 (21)
REC43-	1-1/4 (35)	1 (27)
REC52-	1-1/2 (41)	3/4 (21)
REC53-	1-1/2 (41)	1 (27)
REC54-	1-1/2 (41)	1-1/4 (35)
REC602-	2 (53)	3/4 (21)

Cat. No.	Pipe Size in. (mm)	
	A	B
REC603-	2 (53)	1 (27)
REC604-	2 (53)	1-1/4 (35)
REC605-	2 (53)	1-1/2 (41)
REC75-	2-1/2 (63)	1-1/2 (41)
REC86-	3 (78)	2 (53)
REC97-	3-1/2 (91)	2-1/2 (63)
REC108-	4 (103)	3 (78)
REC01210-	5 (129)	4 (103)

Metric size designator (ANSI C80.1-1994).

Cat. No.	Material	Colour
REC21-	SA = Aluminum	- = space for colour identifier
		G = Grey
		W = White
		B = Blue

Custom colours also available - Std. min. quantities are required. Please contact your Regional Sales Office.

Reduce a Conduit Hub to a Smaller Size

OCAL-BLUE™ Urethane-Coated Reducing Bushings

Cat. No.	Pipe Size in. (mm)	
	A - Male	B - Female
RE21-G	3/4 (21)	1/2 (16)
RE31-G	1 (27)	1/2 (16)
RE32-G	1 (27)	3/4 (21)
RE41-G	1-1/4 (35)	1/2 (16)
RE42-G	1-1/4 (35)	3/4 (21)
RE43-G	1-1/4 (35)	1 (27)
RE51-G	1-1/2 (41)	1/2 (16)
RE52-G	1-1/2 (41)	3/4 (21)

Cat. No.	Pipe Size in. (mm)	
	A - Male	B - Female
RE53-G	1-1/2 (41)	1 (27)
RE54-G	1-1/2 (41)	1-1/4 (35)
RE61-G	2 (53)	1/2 (16)
RE62-G	2 (53)	3/4 (21)
RE63-G	2 (53)	1 (27)
RE64-G	2 (53)	1-1/4 (35)
RE65-G	2 (53)	1-1/2 (41)
RE73-G	2-1/2 (63)	1 (27)

Cat. No.	Pipe Size in. (mm)	
	A - Male	B - Female
RE74-G	2-1/2 (63)	1-1/4 (35)
RE75-G	2-1/2 (63)	1-1/2 (41)
RE76-G	2-1/2 (63)	2 (53)
RE83-G	3 (78)	1 (27)
RE84-G	3 (78)	1-1/4 (35)
RE85-G	3 (78)	1-1/2 (41)
RE86-G	3 (78)	2 (53)
RE87-G	3 (78)	2-1/2 (63)



RE32-G

Cat. No.	Pipe Size in. (mm)	
	A - Male	B - Female
RE96-G	3-1/2 (91)	2 (53)
RE97-G	3-1/2 (91)	2-1/2 (63)
RE98-G	3-1/2 (91)	3 (78)
RE106-G	4 (103)	2 (53)
RE107-G	4 (103)	2-1/2 (63)
RE108-G	4 (103)	3 (78)

Also available in Aluminum (SA).

Metric size designator (ANSI C80.1-1994).