

Circulating Fluid Temperature Controller

Thermo-chiller/Rack Mount Type

Air-cooled Refrigeration

Water-cooled Refrigeration



(UL Standards)

* Refer to page 5 for applicable models.

New An inverter pump mounted option (Option symbol "T1") has been added for the HRR012 to 030 (200 V).

Operable without the need to remove the unit from the rack

Front access

Simple to control, service, and maintain with all filters and drainage accessible via the front panel

Space saving

Multiple chillers can be mounted to a 19-inch rack.

*1 Refer to page 1 for details on 19-inch racks.



Bypass valve (Standard)

Particle filter (Standard)

221 mm

Equivalent to 5U (EIA standards*1)

310 mm

Equivalent to 7U (EIA standards*1)

399 mm

Equivalent to 9U (EIA standards*1)



Cooling capacity 1.1/1.2/1.8/2.4/3.0/5.1 kW (60 Hz)

Temperature stability $\pm 0.1^{\circ}\text{C}$

Global power supply Single-phase 100 VAC (50/60 Hz)/115 VAC (60 Hz)
Single-phase 200 to 230 VAC (50/60 Hz)
3-phase 380 to 415 VAC (50/60 Hz), 460 to 480 VAC (60 Hz)

Thermo-chiller Monitoring Software

Can conduct all setting operations as well as monitor the operating status



- USB 2.0 type B
- Compatible OS: Windows 7/10 (.NET Framework 3.5 or higher)
* A dedicated driver is required to use with Windows 7.
- Supported languages: English, German, Japanese, French, Italian, Russian, Spanish, Turkish, Chinese, Korean

710 mm

Equivalent to 16U (EIA standards*1)



HRR050-A Air-cooled

HRR Series



CAT.ES40-66D ©

Front access

Maintenance

DI filter replacement

Optional Accessories [p. 36](#)



Drain pan (Built-in water leakage sensor)

The leakage sensor detects fluid leakage. The drain pan prevents leaked fluid from pooling at the bottom of the product.

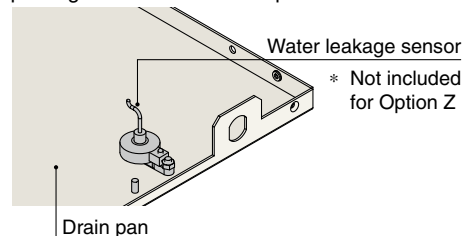

Discharge of the circulating fluid

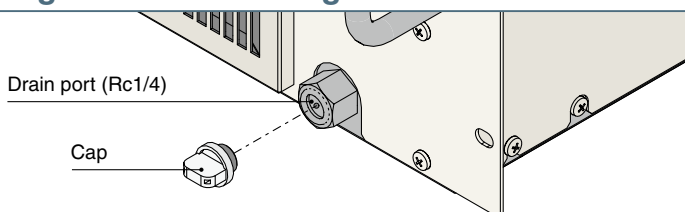

Cleaning of the dustproof filter

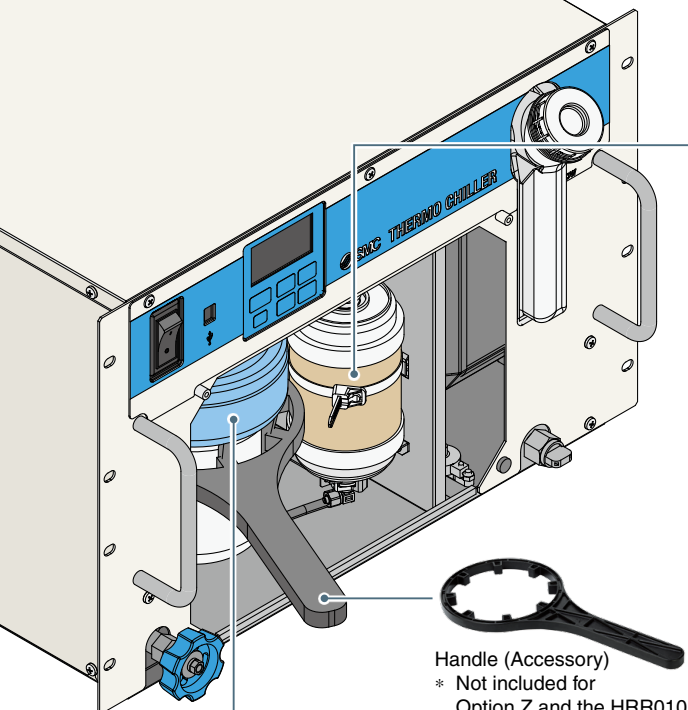
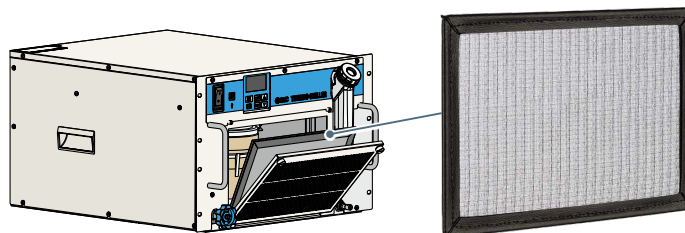

Replacement particle filter element

Optional Accessories [p. 36](#)



Space saving

Footprint can be reduced by **53%** by installing the product in a 19-inch rack (EIA standards*¹).

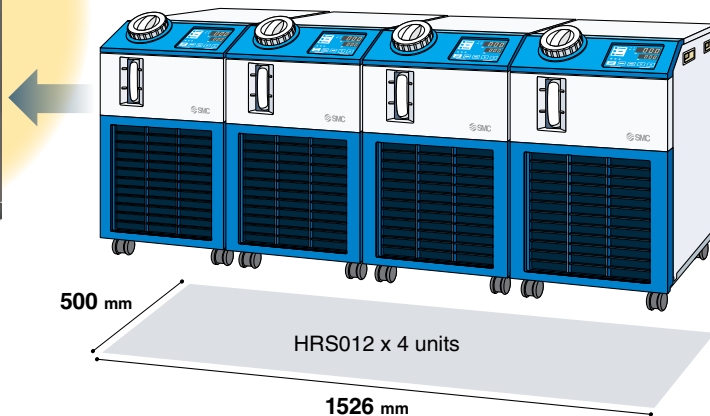
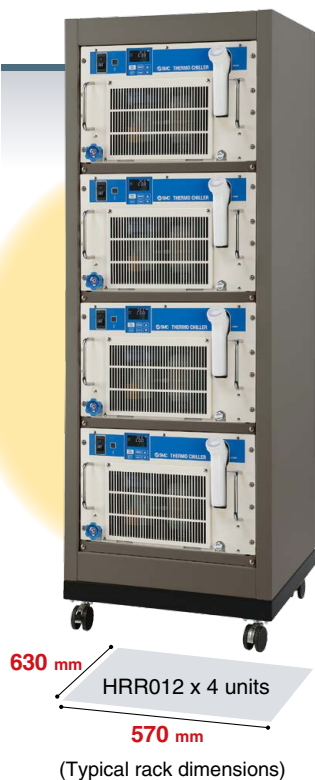

*1 19-inch Rack Standards

Standard	EIA (Electronic Industries Alliance)
Standard no.	EIA310-D
Height	44.5 mm (=1U)
Length	450 mm (min)
Width	483.4 mm

Setting and Adjustment

A bypass valve and flow sensor are built in (standard).

Flow rate and pressure adjustment can be seen on the displayed panel.

- * Option Z does not come with a bypass valve or flow sensor.
- * Option Z1 does not come with a flow sensor.

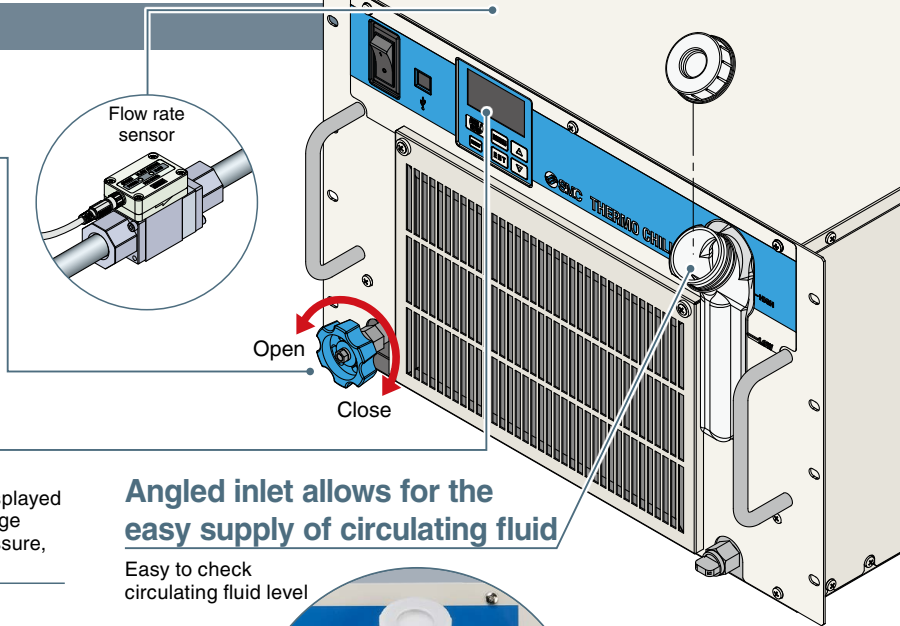

Color LCD screen



Current value (displayed in white): Discharge temperature, pressure, flow rate, etc.

Set value (displayed in green): Set temperature, etc.

Angled inlet allows for the easy supply of circulating fluid

Easy to check circulating fluid level



Height

422 mm reduction

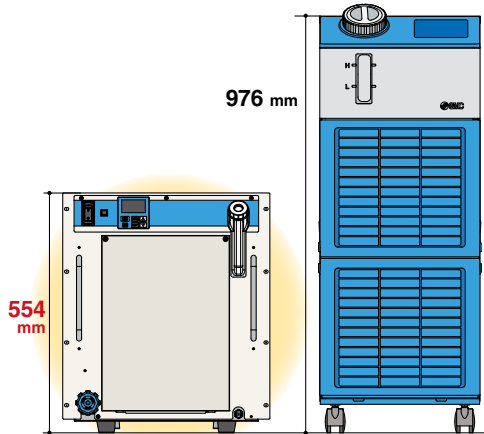

HRR050-W-20-Y **HRS050-W**
(With feet/Without rack mounting brackets)

Volume

35% reduction



HRS050-W **HRR050-W-20-Y**

Caster Adjuster-foot Kit

Optional Accessories **p. 38**

Applicable for installation in locations other than 19-inch racks

This is a set of unfixed casters and adjuster feet stop.

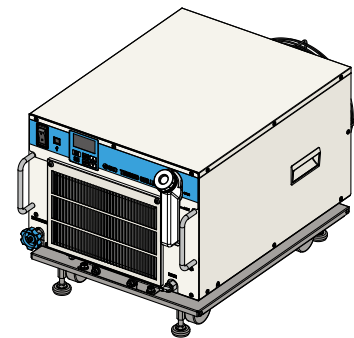

Temperature stability: $\pm 0.1^{\circ}\text{C}$

A precision temperature control method which utilizes expansion valves and temperature sensors allowed for the realization of a product with a high temperature stability of $\pm 0.1^{\circ}\text{C}$.

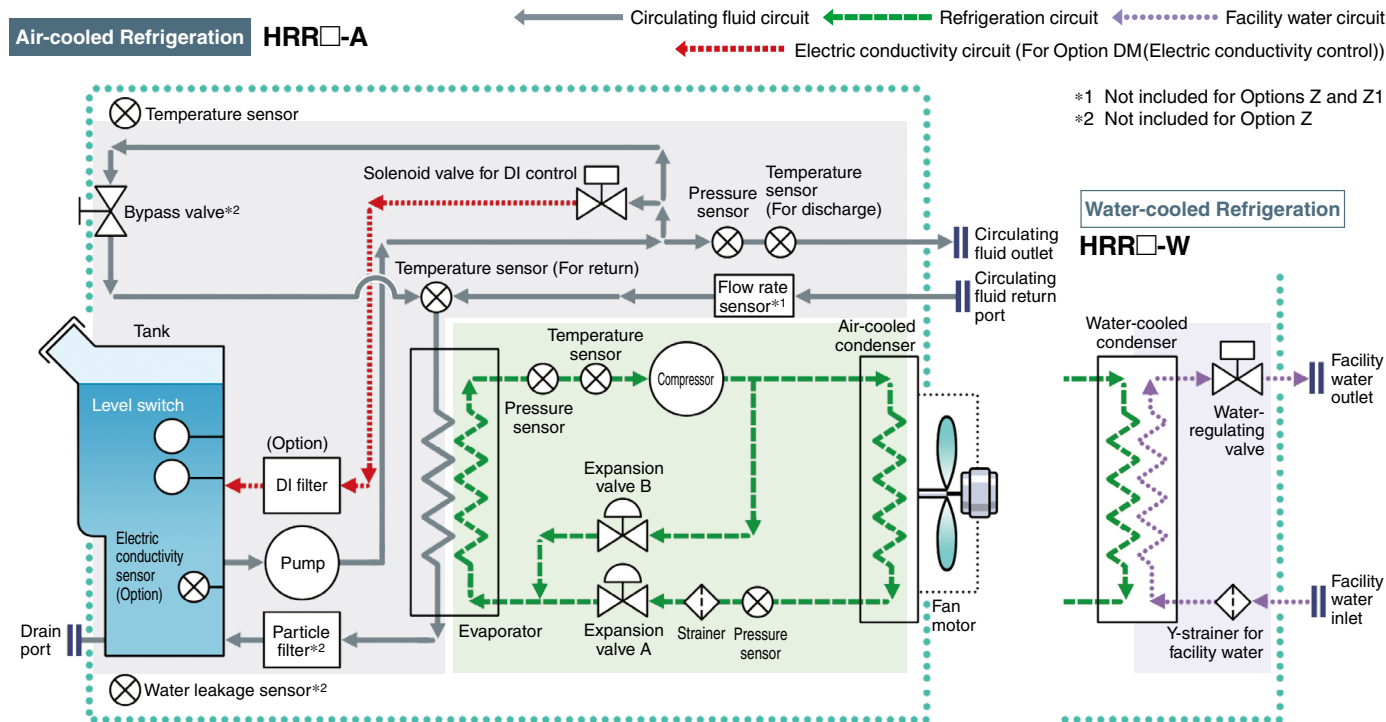

Refrigeration circuit

- The compressor compresses the refrigerant gas and discharges high-temperature, high-pressure refrigerant gas.
- In the case of air-cooled refrigeration, the high-temperature, high-pressure refrigerant gas is cooled down by fan ventilation in the air-cooled condenser, where it is then liquefied. In the case of water-cooled refrigeration, the refrigerant gas is cooled by the facility water in the facility water circuit in the water-cooled condenser, where it is then liquefied.
- The liquefied high-pressure refrigerant gas expands and its temperature lowers when it passes through expansion valve A, where it vaporizes after receiving heat from the circulating fluid in the evaporator.
- The vaporized refrigerant gas is sucked into the compressor and compressed again.
- When heating the circulating fluid, the high-pressure, high-temperature refrigerant gas is bypassed into the evaporator by expansion valve B to heat the circulating fluid.

Point The combination of the precise control of **expansion valve A** for cooling and **expansion valve B** for heating allows for high temperature stability.

Circulating fluid circuit

- After the circulating fluid discharged from the pump is heated or cooled by the user's equipment, it returns to the thermo-chiller.
- The circulating fluid is controlled to remain at a set temperature by the refrigeration circuit. It will then be discharged to the user's equipment side again by the thermo-chiller.

Point Since the refrigeration circuit is controlled by the signals from **2 temperature sensors (for return and discharge)**, precise temperature control of the circulating fluid can be achieved. Therefore, there is no need for a tank with a large capacity to absorb the circulating fluid temperature difference, as high temperature stability can be achieved even with a **small-size tank**. This also contributes to space saving.

Facility water circuit

For water-cooled refrigeration HRR□-W

- The water-regulating valve opens and closes to keep the refrigerant gas pressure consistent. The facility water flow rate is controlled by the water-regulating valve.

Air-cooled Refrigeration HRR050-A

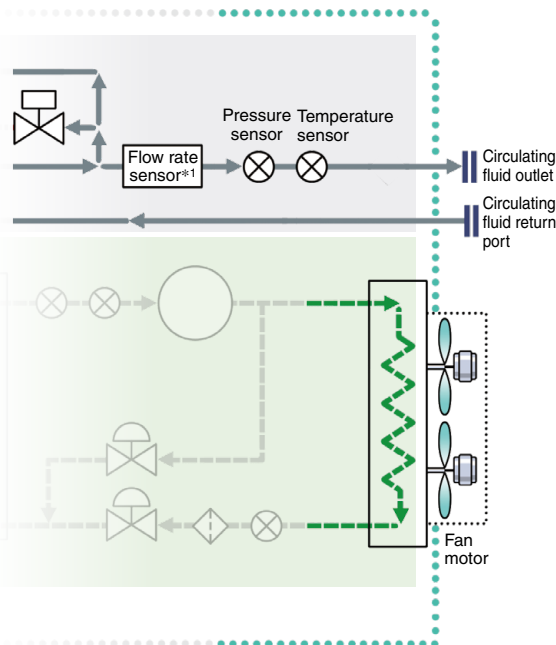

Self-diagnosis function and alarm code display

Display of 28 types of alarm codes (For details → p. 29)

Operation is monitored at all times by the integrated sensor. The applicable alarm code (28 types) is displayed after self-diagnosis.

Changeable alarm set values

Setting item	Set range*1
Circulating fluid discharge temperature rise	5 to 45°C
Circulating fluid discharge temperature drop	1 to 35°C
Circulating fluid discharge pressure rise	0.05 to 0.5 MPa
Circulating fluid flow rate reduction	2.0 to 15.0 LPM

*1 Set values vary depending on the model.



Menu for maintenance schedule

When it is time for periodical checks of the pumps, fan motor, dustproof filter, etc., a maintenance code will be generated as a reminder. Helpful for facility maintenance

Ex.) MT01 "Pump maintenance notice"

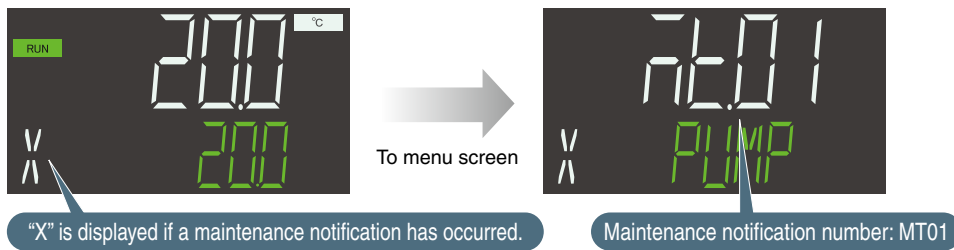

Displaying screen for operating conditions

Thermo-chiller internal temperature, pressure, etc., can be displayed.

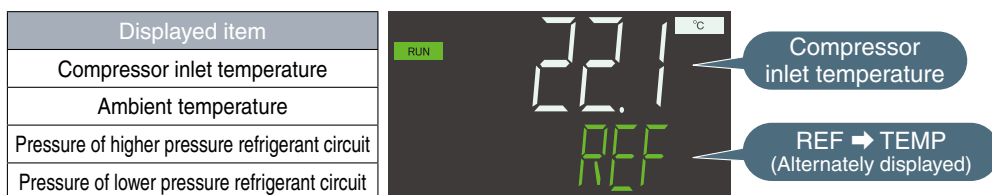

With heating function

As the heating method uses discharged heat, a heater is unnecessary. The heating function is effective in maintaining a constant temperature, particularly in the winter when the ambient temperature is low.

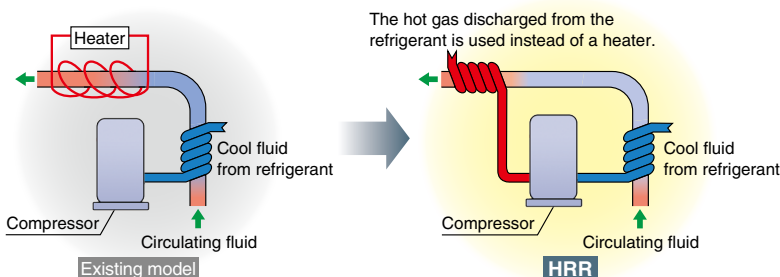

* This is just an example diagram.



Communication functions

Serial communication (RS-232C/RS-485) and contact input/output signals (2 inputs and 3 outputs) are equipped as standard. This allows for communication with the user's equipment and system construction, depending on the application.

Ex. 1
Remote signal I/O through serial communication
 Remote operation is enabled (to start and stop operation) through serial communication.

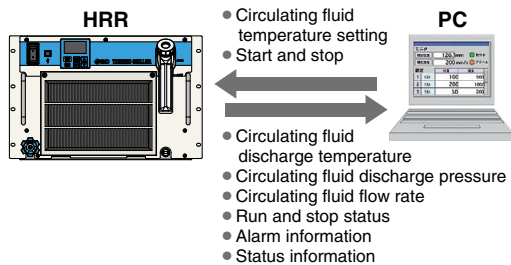

Ex. 2
Remote operation signal input
 The chiller can be operated remotely by contact input signals.

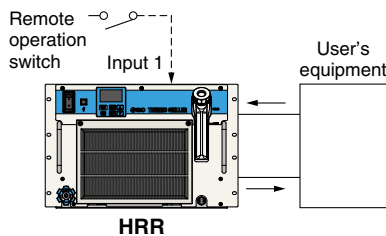

Ex. 3
Alarm and operation status (start, stop, etc.) signal output
 The alarm and status generated in the product are assigned to 3 output signals based on their contents, which can then be output.

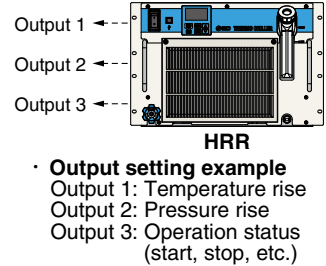

Thermo-chiller Monitoring Software

The operation manual and monitoring software can be downloaded here.

Variations

Model	Height U ^{※1}	Cooling capacity [W] (50/60 Hz)	Heating capacity [W] (50/60 Hz)	Cooling method	Temperature stability	Power supply	Circulating fluid	Option (pp. 32 to 35)	Optional accessories (pp. 36 to 38)	International standards	
 HRR010	5U	770/950	340/430	• Air-cooled refrigeration	±0.1°C	• Single-phase 100 VAC (50/60 Hz)/ 115 VAC (60 Hz)	• Tap water • 15% ethylene glycol aqueous solution	• With electric conductivity control function, Applicable to DI water piping • Applicable to DI water piping	• Concentration meter • Particle filter element for replacement	CE (Pending for UL Standards)	
		950/1100	250/300	• Air-cooled refrigeration		• Single-phase 200 to 230 VAC (50/60 Hz)				• DI filter replacement cartridge	CE MET _{us} (UL Standards)
		1000/1100	200/200	• Water-cooled refrigeration		• Single-phase 100 VAC (50/60 Hz)/ 115 VAC (60 Hz) • Single-phase 200 to 230 VAC (50/60 Hz)				• High-pressure pump mounted*2	• (Air-cooled: Option U) (Water-cooled: Standard) (Option T1: Pending for UL Standards)
				• Water-cooled refrigeration						• Inverter pump mounted*3	
 HRR012 HRR018	7U	1000/1200	• 400/500 (100 V type) • 450/500 (200 V type)	• Air-cooled refrigeration	±0.1°C	• Single-phase 100 VAC (50/60 Hz)/ 115 VAC (60 Hz) • Single-phase 200 to 230 VAC (50/60 Hz)	• Tap water • 15% ethylene glycol aqueous solution	• Applicable to DI water piping	• DI filter replacement cartridge	CE MET _{us} (UL Standards)	
		1600/1800		• Water-cooled refrigeration							• High-pressure inverter pump mounted*4
 HRR024 HRR030	9U	2000/2400	550/700	• Water-cooled refrigeration	±0.1°C	• Single-phase 200 to 230 VAC (50/60 Hz)	• Tap water • 15% ethylene glycol aqueous solution	• High-pressure pump mounted*2	• Anti-quake bracket*5	• Piping conversion fitting	CE MET _{us} (UL Standards)
		2500/3000		• Air-cooled refrigeration							
 HRR050	16U	4600/5100	1000/1200	• Air-cooled refrigeration	±0.1°C	• Single-phase 200 to 230 VAC (50/60 Hz)	• Tap water • 15% ethylene glycol aqueous solution	• With feet/Without rack mounting brackets	• Power supply cable	• Caster adjuster-foot kit*5	CE MET _{us} (UL Standards)
	12U	5000/5900		• Water-cooled refrigeration							
 HRR050	16U	4800/5800	1100/1200	• Air-cooled refrigeration	±0.1°C	• 3-phase 380 to 415 VAC (50/60 Hz), 460 to 480 VAC (60 Hz)	• Tap water • 15% ethylene glycol aqueous solution	• High-pressure inverter pump mounted*4	• Piping conversion fitting	• Power supply cable	CE (Pending for UL Standards)
		5500/5900		• Water-cooled refrigeration							

*1 1U = 44.5 mm For detailed dimensions, refer to "Dimensions" on page 25 onward. *2 Applicable to the HRR012 to 030 *3 Applicable to the HRR010 to 030 and HRR050-□-40
 *4 Applicable to the HRR050-□-40 *5 Only applicable to the option Y: with feet/without rack mounting brackets

Inverter specification mechanical sealless pump

HRR010 to 030 Option T1, HRR050-□-40

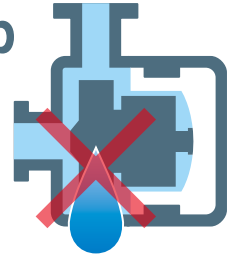

- As the pump has no external leakage of the circulating fluid, a periodic leakage check and replacement of the mechanical seal are not necessary.
- Circulating fluid pressure adjustable (Pressure adjustment via bypass piping is not required.)
- There is no pump capacity difference between the 50 Hz and the 60 Hz.

Power supply (24 VDC) available

Power can be supplied from the contact input/output communication connector to external switches, etc.

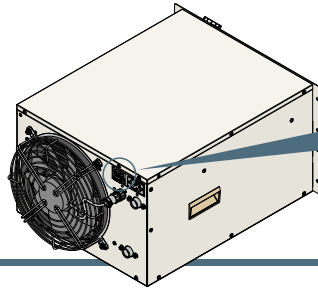

Contact input/output communication connector

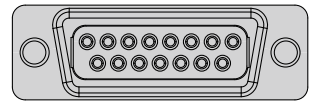

D-sub 15-pin female (socket) type

Application Examples

Laser machining

Cooling of the laser irradiated part

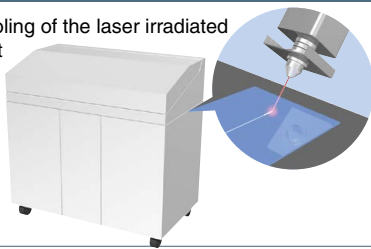

UV curing device (Printing, painting, bonding, and sealing)

Cooling of the UV lamp

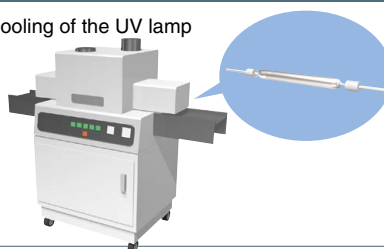

X-ray (digital) instrument

Temperature control of the X-ray tube and X-ray light sensing part

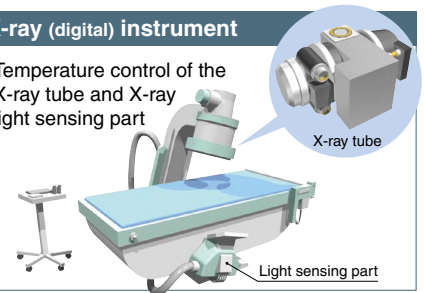

Electronic microscope

Temperature control of the electron-beam irradiated part

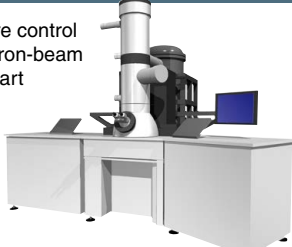

Laser marker

Cooling of the laser irradiated part



Ultrasonic wave inspection machine

Temperature control of the ultrasonic wave laser part



Laser oscillator

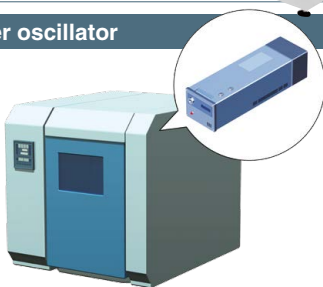

Transmission cable connector for fiber laser

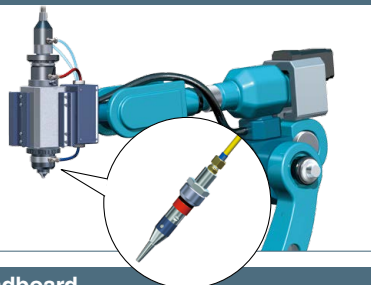

Semiconductor laser



Optical camera (CMOS)



Breadboard

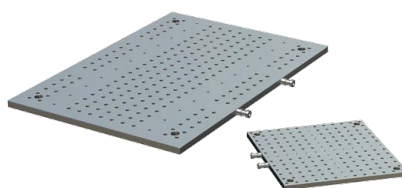

3D metal printer



Global Supply Network

SMC has a comprehensive network in the global market.

We now have a presence of more than 560 branch offices and distributors in 83 countries and regions worldwide. With this global network, we are able to provide a global supply of our substantial range of products and high-quality customer service. We also provide full support to local factories, foreign manufacturing companies, and Japanese companies in each country.



Circulating Fluid/Facility Water Line Equipment

For details, refer to the SMC website.

Pressure Switch: Monitors the pressure of the circulating fluid and facility water

**3-Screen Display
High-Precision Digital Pressure
Switch for General Fluids**



ISE20C(H)

ISE7□G

**Pressure Sensor for
General Fluids**



PSE56□

PSE57□

Pressure Sensor Controller



PSE200A

PSE300A

PSE300AC

For details, refer to the SMC website.

Fittings and Tubing

S Coupler *KK*



**S Coupler/Stainless Steel
(Stainless Steel 304) *KKA***



Tubing *T*□



Metal One-touch Fittings *KQB2*



**Stainless Steel 316
One-touch Fittings *KQG2***



Stainless Steel 316 Insert Fittings *KFG2*

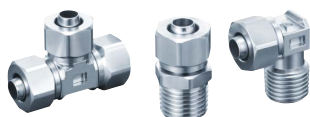

Fluoropolymer Fittings *LQ*



Series	Material
T	Nylon
TU	Polyurethane
TH	FEP (Fluoropolymer)
TD	Modified PTFE (Soft fluoropolymer)
TL	Super PFA
TLM	PFA

CONTENTS

HRR Series



Thermo-chiller/Rack Mount Type HRR Series

HRR010

How to Order

Air-cooled Refrigeration (Single-phase 100/115 VAC)	p. 8-1
Water-cooled Refrigeration (Single-phase 100/115 VAC)	p. 8-1
Air-cooled Refrigeration (Single-phase 200 to 230 VAC)	p. 9
Water-cooled Refrigeration (Single-phase 200 to 230 VAC)	p. 9

Specifications

Air-cooled Refrigeration (Single-phase 100/115 VAC)	p. 8-2
Water-cooled Refrigeration (Single-phase 100/115 VAC)	p. 8-3
Air-cooled Refrigeration (Single-phase 200 to 230 VAC)	p. 10
Water-cooled Refrigeration (Single-phase 200 to 230 VAC)	p. 11

HRR012/018

How to Order

Air-cooled Refrigeration (Single-phase 100/115 VAC)	p. 12
Water-cooled Refrigeration (Single-phase 100/115 VAC)	p. 12

Specifications

Air-cooled Refrigeration (Single-phase 100/115 VAC)	p. 13
Water-cooled Refrigeration (Single-phase 100/115 VAC)	p. 13

HRR012/018/024/030

How to Order

Air-cooled Refrigeration (Single-phase 200 to 230 VAC)	p. 14
Water-cooled Refrigeration (Single-phase 200 to 230 VAC)	p. 14

Specifications

Air-cooled Refrigeration (Single-phase 200 to 230 VAC)	p. 15
Water-cooled Refrigeration (Single-phase 200 to 230 VAC)	p. 16

HRR050

How to Order

Air-cooled Refrigeration (Single-phase 200 to 230 VAC)	p. 17
Water-cooled Refrigeration (Single-phase 200 to 230 VAC)	p. 17
Air-cooled refrigeration (3-phase 400 VAC)	p. 19-1
Water-cooled refrigeration (3-phase 400 VAC)	p. 19-1

Specifications

Air-cooled Refrigeration (Single-phase 200 to 230 VAC)	p. 18
Water-cooled Refrigeration (Single-phase 200 to 230 VAC)	p. 19
Air-cooled refrigeration (3-phase 400 VAC)	p. 19-2
Water-cooled refrigeration (3-phase 400 VAC)	p. 19-3

Cooling Capacity	pp. 20, 21
Heating Capacity	pp. 22, 23, 23-1
Pump Capacity	p. 24
Required Facility Water Flow Rate	p. 24
Dimensions	

Air-cooled Refrigeration	pp. 25, 26, 28, 28-1
Water-cooled Refrigeration	pp. 25, 27, 28, 28-1

Operation Display Panel	p. 29
Alarm	p. 29
Communication Functions	pp. 30, 31

Options

With Electric Conductivity Control Function, Applicable to DI Water Piping	p. 32
Applicable to DI Water Piping	p. 32
Inverter Pump Mounted	p. 33
High-Pressure Pump Mounted	p. 34
With Feet/Without Rack Mounting Brackets	p. 35
Removed Parts	p. 35

Optional Accessories

① Concentration Meter	p. 36
② Particle Filter Element for Replacement	p. 36
③ DI Filter Replacement Cartridge	p. 36
④ Anti-quake Bracket	p. 36
⑤ Piping Conversion Fitting (For Air-cooled Refrigeration)	p. 37
⑥ Piping Conversion Fitting (For Water-cooled Refrigeration)	p. 37
⑦ Power Supply Cable	p. 37
⑧ Caster Adjuster-foot Kit	p. 38

Cooling Capacity Calculation

Required Cooling Capacity Calculation	pp. 39, 40
Precautions on Cooling Capacity Calculation	p. 40
Circulating Fluid Typical Physical Property Values	p. 40

Specific Product Precautions	pp. 41 to 45
------------------------------	--------------

Thermo-chiller/Rack Mount Type Single-phase 100/115 VAC



HRR010



Air-cooled refrigeration



Water-cooled refrigeration

How to Order

Air-cooled Refrigeration

HRR 010 - A [] - 10 - [] U []

Cooling capacity

010	770/950 W (50/60 Hz)
-----	----------------------

Cooling method

A	Air-cooled refrigeration
---	--------------------------

Pipe thread type

Nil	Rc
F	G (With Rc-G conversion fitting set)
N	NPT (With Rc-NPT conversion fitting set)

Power supply

10	Single-phase 100 VAC (50/60 Hz) Single-phase 115 VAC (60 Hz)
----	---

Option 2 (p. 35)

Nil	None
Y	With feet/Without rack mounting brackets
Z*1	Without either a flow sensor, water leakage sensor, particle filter, bypass valve or retaining clip
Z1*1	Without either a flow sensor or retaining clip

*1 Only Option Z or Z1 can be selected.

Option 1 (pp. 32, 33)

Nil	None
DM	With electric conductivity control function, Applicable to DI water piping
M	Applicable to DI water piping
T1	Inverter pump mounted

· When multiple options are combined, indicate symbols in alphabetical order.



Water-cooled Refrigeration

HRR 010 - W [] - 10 - [] U []

Cooling capacity

010	720/860 W (50/60 Hz)
-----	----------------------

Cooling method

W	Water-cooled refrigeration
---	----------------------------

Pipe thread type

Nil	Rc
F	G (With Rc-G conversion fitting set)
N	NPT (With Rc-NPT conversion fitting set)

Power supply

10	Single-phase 100 VAC (50/60 Hz) Single-phase 115 VAC (60 Hz)
----	---

Option 2 (p. 35)

Nil	None
Y	With feet/Without rack mounting brackets
Z*1	Without either a flow sensor, water leakage sensor, particle filter, bypass valve or retaining clip
Z1*1	Without either a flow sensor or retaining clip

*1 Only Option Z or Z1 can be selected.

Option 1 (pp. 32, 33)

Nil	None
DM	With electric conductivity control function, Applicable to DI water piping
M	Applicable to DI water piping
T1	Inverter pump mounted

· When multiple options are combined, indicate symbols in alphabetical order.



Specifications: 100/115 VAC Air-cooled Refrigeration

Model	HRR010-A-10	
Cooling method	Air-cooled refrigeration	
Refrigerant	R134a (HFC)	
Refrigerant charge [kg]	0.24	
Control method	PID control	
Ambient temperature/Humidity/Altitude*1, 14	Temperature: 5 to 40°C, Humidity: 30 to 70%, Altitude: less than 3000 m	
Circulating fluid system	Circulating fluid*2	Tap water, 15% ethylene glycol aqueous solution
	Set temperature range*1 [°C]	15 to 35
	Cooling capacity (50/60 Hz)*3 [W]	770/950
	Heating capacity (50/60 Hz)*4 [W]	340/430
	Temperature stability*5 [°C]	±0.1
	Pump capacity (50/60 Hz)*6 [MPa]	0.09 (at 5 L/min)/0.11 (at 5 L/min) For Option T1: 0.35 (at 5 L/min)/0.35 (at 5 L/min)
	Rated flow (50/60 Hz)*7 [L/min]	5/5 For Option T1: 5/5
	Flow display range*20 [L/min]	2 to 16
	Electric conductivity display range [µS/cm]	0.1 to 48 (Only for Option DM)
	Electric conductivity setting range [µS/cm]	0.5 to 45 (Only for Option DM)
	Particle filter nominal filtration rating*19 [µm]	35
	Bypass valve*19	Installed
	Tank capacity [L]	Approx. 3
	Outlet, Return port size	Rc1/2
	Drain port size	Rc1/4, With cap
Leakage protection	Drain pan (With water leakage sensor*19)	
Fluid contact material	Stainless steel, Copper (Heat exchanger brazing)*12, Alumina ceramic, Carbon, PP, PE, PPE, POM, PET, PA, FKM, EPDM, NBR, PVC, PPS, Fluoropolymer*13, Ion exchange resin*13	
Electrical system	Power supply	Single-phase 100 VAC (50/60 Hz), Single-phase 115 VAC (60 Hz) Allowable voltage range ±10%*15
	Circuit protector [A]	15
	Applicable earth leakage breaker capacity*8	Rated current: 15 A Sensitivity current: 30 mA
	Cable quantity x Size (Including grounding cable)*16	3 cores x 14 AWG (3 cores x 2.0 mm ²)
	Rated operating current (50/60 Hz)*17 [A]	6.2/7.7
		For Option T1 9.5/10.7
	Rated power consumption (50/60 Hz)*17 [kW (kVA)]	0.50/0.67 (0.56/0.70)
For Option T1 0.72/0.84 (0.86/0.96)		
Communication function	Contact input/output, Serial RS-485/RS-232C	
Noise level (50/60 Hz)*9 [dB(A)]	60/60	
Dimensions*10 [mm]	W 483 x D 550 x H 221	
Accessories*18	Power supply connector, Operation manual, Particle filter element*19	
Weight*11 [kg]	32	

*1 No condensation should be present. During seasons or in locations where the ambient temperature is likely to fall below freezing point, please contact SMC.

*2 If tap water is used, use water that is compliant with the Water Quality Standards of the Japan Refrigeration and Air Conditioning Industry Association (JRA GL-02-1994 cooling water system - circulating type - make-up water).

*3 ① Ambient temperature: 25°C, ② Circulating fluid temperature: 20°C, ③ Circulating fluid at the rated flow, ④ Circulating fluid: Tap water, ⑤ Power supply: 100 VAC, ⑥ Piping length: Shortest
For models with an inverter pump mounted (Option T1), the cooling capacity will decrease by 300 W.

*4 ① Ambient temperature: 25°C, ② Circulating fluid temperature: 20°C, ③ Circulating fluid at the rated flow, ④ Circulating fluid: Tap water, ⑤ Power supply: 100 VAC, ⑥ Piping length: Shortest

*5 Temperature at the thermo-chiller outlet when the circulating fluid flow is at the rated flow and the circulating fluid outlet and return port are directly connected
The installation environment and power supply are within the specification range and stable.

*6 The capacity at the thermo-chiller outlet when the circulating fluid temperature is 20°C

*7 The required flow rate for maintaining the cooling capacity or temperature stability

The specification of the cooling capacity and the temperature stability may not be satisfied if the flow rate is lower than the rated flow.

*8 Purchase an earth leakage breaker with a sensitivity current of 30 mA and a power supply of 100 VAC separately.

*9 Front: 1 m, height: 1 m, stable with no load, Other conditions → See *4.

*10 Dimensions between panels, not including the dimensions of protrusion
When Option Y (With feet/Without rack mounting brackets) is selected, refer to page 35.

*11 Weight in the dry state without circulating fluids
The weight will increase by 1 kg when Option DM (With electric conductivity control function, Applicable to DI water piping) is selected.
The weight will increase by 2 kg when Option T1 (Inverter pump mounted) is selected.

*12 Option M (Applicable to DI water piping) does not contain copper.

*13 For Option DM (With electric conductivity control function, Applicable to DI water piping)

*14 If the product is used at an altitude of 1000 m or higher, refer to "For altitudes of 1000 m or higher" on page 42.

*15 No continuous voltage fluctuation

*16 To be prepared by the customer

*17 ① Ambient temperature: 25°C, ② Circulating fluid temperature: 20°C, ③ Circulating fluid at the rated flow, ④ Circulating fluid: Tap water, ⑤ Power supply: 100 VAC, ⑥ Piping length: Shortest, ⑦ With the rated cooling load applied

*18 For Option DM (With electric conductivity control function, Applicable to DI water piping), a DI filter is included.

For pipe thread type F, a G thread conversion fitting set is included.

For pipe thread type N, an NPT thread conversion fitting set is included.

*19 Not included for Option Z (Removed parts)

*20 Not included for Options Z and Z1 (Removed parts)

Specifications: 100/115 VAC Water-cooled Refrigeration

Model		HRR010-W-10	
Cooling method		Water-cooled refrigeration	
Refrigerant		R134a (HFC)	
Refrigerant charge [kg]		0.17	
Control method		PID control	
Ambient temperature/Humidity/Altitude*1, 15		Temperature: 5 to 40°C, Humidity: 30 to 70%, Altitude: less than 3000 m	
Circulating fluid system	Circulating fluid*2	Tap water, 15% ethylene glycol aqueous solution	
	Set temperature range*1 [°C]	15 to 35	
	Cooling capacity (50/60 Hz)*3 [W]	720/860	
	Heating capacity (50/60 Hz)*4 [W]	360/480	
	Temperature stability*5 [°C]	±0.1	
	Pump capacity (50/60 Hz)*6 [MPa]	0.09 (at 5 L/min)/0.11 (at 5 L/min) For Option T1: 0.35 (at 5 L/min)/0.35 (at 5 L/min)	
	Rated flow (50/60 Hz)*7 [L/min]	5/5 For Option T1: 5/5	
	Flow display range*21 [L/min]	2 to 16	
	Electric conductivity display range [µS/cm]	0.1 to 48 (Only for Option DM)	
	Electric conductivity setting range [µS/cm]	0.5 to 45 (Only for Option DM)	
	Particle filter nominal filtration rating*20 [µm]	35	
	Bypass valve*20	Installed	
	Tank capacity [L]	Approx. 3	
	Outlet, Return port size	Rc1/2	
Drain port size	Rc1/4, With cap		
Leakage protection	Drain pan (With water leakage sensor*20)		
Fluid contact material	Stainless steel, Copper (Heat exchanger brazing)*12, Alumina ceramic, Carbon, PP, PE, PPE, POM, PET, PA, FKM, EPDM, NBR, PVC, PPS, Fluoropolymer*13, Ion exchange resin*13		
Facility water system	Temperature range [°C]	5 to 35	
	Pressure range [MPa]	0.3 to 0.5	
	Required flow rate*14 [L/min]	6	
	Inlet-outlet pressure differential of facility water [MPa]	0.3 or more	
	Port size	Rc3/8	
	Fluid contact material	Stainless steel, Copper (Heat exchanger brazing), Bronze, Brass, Synthetic rubber	
Electrical system	Power supply	Single-phase 100 VAC (50/60 Hz), Single-phase 115 VAC (60 Hz) Allowable voltage range ±10%*16	
	Circuit protector [A]	15	
	Applicable earth leakage breaker capacity*8	Rated current: 15 A Sensitivity current: 30 mA	
	Cable quantity x Size (Including grounding cable)*17	3 cores x 14 AWG (3 cores x 2.0 mm ²)	
	Rated operating current (50/60 Hz)*18 [A]		5.4/6.6 For Option T1 8.7/9.6
		Rated power consumption (50/60 Hz)*18 [kW (kVA)]	
	Communication function		Contact input/output, Serial RS-485/RS-232C
Noise level (50/60 Hz)*9 [dB(A)]	60/60		
Dimensions*10 [Mm]	W 483 x D 550 x H 221		
Accessories*19	Power supply connector, Operation manual, Particle filter element*20		
Weight*11 [kg]	30		

*1 No condensation should be present. During seasons or in locations where the ambient temperature is likely to fall below freezing point, please contact SMC.

*2 If tap water is used, use water that is compliant with the Water Quality Standards of the Japan Refrigeration and Air Conditioning Industry Association (JRA GL-02-1994 cooling water system - circulating type - make-up water).

*3 ① Facility water temperature: 25°C, ② Circulating fluid temperature: 20°C, ③ Circulating fluid at the rated flow, ④ Circulating fluid: Tap water, ⑤ Power supply: 100 VAC, ⑥ Piping length: Shortest
For models with an inverter pump mounted (Option T1), the cooling capacity will decrease by 300 W.

*4 ① Ambient temperature: 25°C, ② Facility water temperature: 25°C, ③ Circulating fluid temperature: 20°C, ④ Circulating fluid at the rated flow, ⑤ Circulating fluid: Tap water, ⑥ Power supply: 100 VAC, ⑦ Piping length: Shortest

*5 Temperature at the thermo-chiller outlet when the circulating fluid flow is at the rated flow and the circulating fluid outlet and return port are directly connected. The installation environment and power supply are within the specification range and stable.

*6 The capacity at the thermo-chiller outlet when the circulating fluid temperature is 20°C

*7 The required flow rate for maintaining the cooling capacity or temperature stability

The specification of the cooling capacity and the temperature stability may not be satisfied if the flow rate is lower than the rated flow.

*8 Purchase an earth leakage breaker with a sensitivity current of 30 mA and a power supply of 100 VAC separately.

*9 Front: 1 m, height: 1 m, stable with no load, Other conditions → See *4.

*10 Dimensions between panels, not including the dimensions of protrusion. When Option Y (With feet/Without rack mounting brackets) is selected, refer to page 35.

*11 Weight in the dry state without circulating fluids and facility water (for water-cooled refrigeration)

The weight will increase by 1 kg when Option DM (With electric conductivity control function, Applicable to DI water piping) is selected.

The weight will increase by 2 kg when Option T1 (Inverter pump mounted) is selected.

*12 Option M (Applicable to DI water piping) does not contain copper.

*13 For Option DM (With electric conductivity control function, Applicable to DI water piping)

*14 The required flow rate when the cooling capacity load is applied under the conditions in *3

*15 If the product is used at an altitude of 1000 m or higher, refer to "For altitudes of 1000 m or higher" on page 42.

*16 No continuous voltage fluctuation

*17 To be prepared by the customer

*18 ① Facility water temperature: 25°C, ② Circulating fluid temperature: 20°C, ③ Circulating fluid at the rated flow, ④ Circulating fluid: Tap water, ⑤ Power supply: 100 VAC, ⑥ Piping length: Shortest, ⑦ With the rated cooling load applied

*19 For Option DM (With electric conductivity control function, Applicable to DI water piping), a DI filter is included.

For pipe thread type F, a G thread conversion fitting set is included.

For pipe thread type N, an NPT thread conversion fitting set is included.

*20 Not included for Option Z (Removed parts)

*21 Not included for Options Z and Z1 (Removed parts)

Thermo-chiller/Rack Mount Type Single-phase 200 to 230 VAC

RoHS

HRR010



Air-cooled refrigeration



Water-cooled refrigeration

How to Order

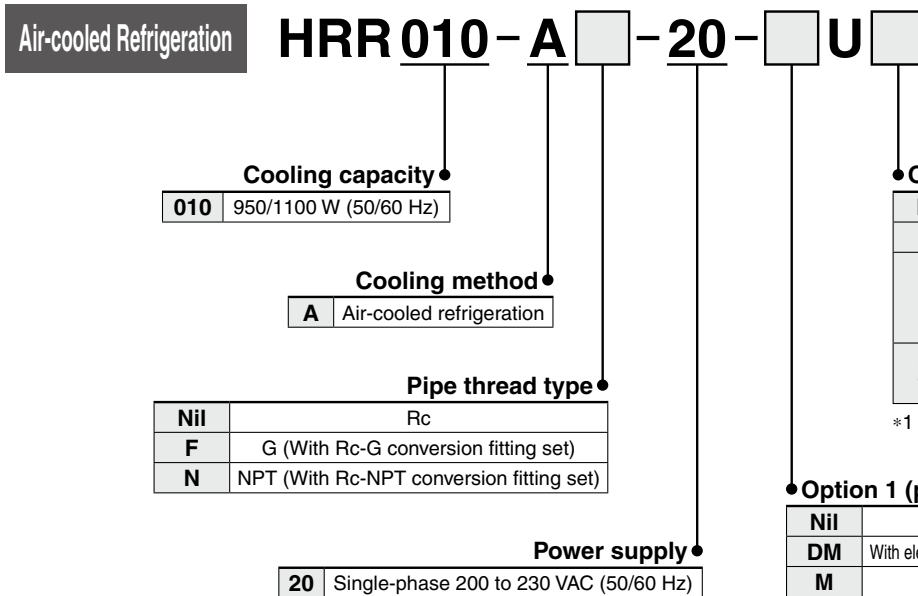

• Option 2 (p. 35)

Nil	None
Y	With feet/Without rack mounting brackets
Z*1	Without either a flow sensor, water leakage sensor, particle filter, bypass valve or retaining clip
Z1*1	Without either a flow sensor or retaining clip

*1 Only Option Z or Z1 can be selected.

• Option 1 (pp. 32, 33)

Nil	None
DM	With electric conductivity control function, Applicable to DI water piping
M	Applicable to DI water piping
T1	Inverter pump mounted

· When multiple options are combined, indicate symbols in alphabetical order.

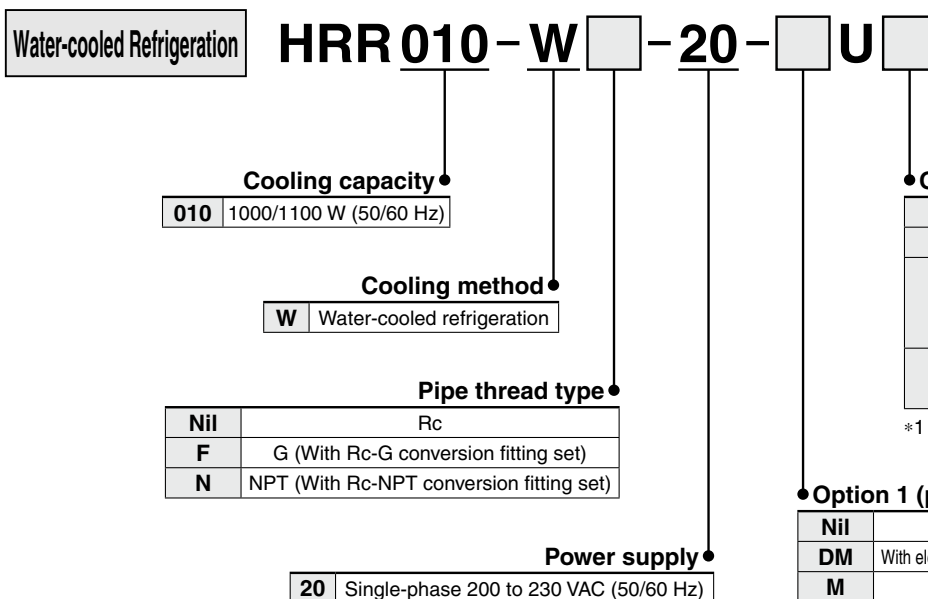

• Option 2 (p. 35)

Nil	None
Y	With feet/Without rack mounting brackets
Z*1	Without either a flow sensor, water leakage sensor, particle filter, bypass valve or retaining clip
Z1*1	Without either a flow sensor or retaining clip

*1 Only Option Z or Z1 can be selected.

• Option 1 (pp. 32, 33)

Nil	None
DM	With electric conductivity control function, Applicable to DI water piping
M	Applicable to DI water piping
T1	Inverter pump mounted

· When multiple options are combined, indicate symbols in alphabetical order.

Specifications: 200 to 230 VAC Air-cooled Refrigeration

Model	HRR010-A-20	
Cooling method	Air-cooled refrigeration	
Refrigerant	R410A (HFC)	
Refrigerant charge [kg]	0.22	
Control method	PID control	
Ambient temperature/Humidity/Altitude*1, 14	Temperature: 5 to 40°C, Humidity: 30 to 70%, Altitude: less than 3000 m	
Circulating fluid system	Circulating fluid*2	Tap water, 15% ethylene glycol aqueous solution
	Set temperature range*1 [°C]	15 to 35
	Cooling capacity (50/60 Hz)*3 [W]	950/1100
	Heating capacity (50/60 Hz)*4 [W]	250/300
	Temperature stability*5 [°C]	±0.1
	Pump capacity (50/60 Hz)*6 [MPa]	0.09 (at 5 L/min)/0.11 (at 5 L/min) For Option T1: 0.35 (at 5 L/min)/0.35 (at 5 L/min)
	Rated flow (50/60 Hz)*7 [L/min]	5/5 For Option T1: 5/5
	Flow display range*20 [L/min]	2 to 16
	Electric conductivity display range [µS/cm]	0.1 to 48 (Only for Option DM)
	Electric conductivity setting range [µS/cm]	0.5 to 45 (Only for Option DM)
	Particle filter nominal filtration rating*19 [µm]	35
	Bypass valve*19	Installed
	Tank capacity [L]	Approx. 3
	Outlet, Return port size	Rc1/2
	Drain port size	Rc1/4, With cap
	Leakage protection	Drain pan (With water leakage sensor*19)
Fluid contact material	Stainless steel, Copper (Heat exchanger brazing)*12, Alumina ceramic, Carbon, PP, PE, PPE, POM, PET, PA, FKM, EPDM, NBR, PVC, PPS, Fluoropolymer*13, Ion exchange resin*13	
Electrical system	Power supply	Single-phase 200 to 230 VAC, 50/60 Hz, Allowable voltage range ±10%*15
	Circuit protector [A]	10
	Applicable earth leakage breaker capacity*8	Rated current: 10 A Sensitivity current: 30 mA
	Cable quantity x Size (Including grounding cable)*16	3 cores x 14 AWG (3 cores x 2.0 mm ²)
	Rated operating current (50/60 Hz)*17 [A]	2.5/3.0
		For Option T1 4.3/4.7
Rated power consumption (50/60 Hz)*17 [kW (kVA)]	0.48/0.60 (0.51/0.61)	
	For Option T1 0.73/0.80 (0.85/0.94)	
Communication function	Contact input/output, Serial RS-485/RS-232C	
Noise level (50/60 Hz)*9 [dB(A)]	59/59	
Dimensions*10 [mm]	W 483 x D 550 x H 221	
Accessories*18	Power supply connector, Operation manual, Particle filter element*19	
Weight*11 [kg]	29	

*1 No condensation should be present. During seasons or in locations where the ambient temperature is likely to fall below freezing point, please contact SMC.
 *2 If tap water is used, use water that is compliant with the Water Quality Standards of the Japan Refrigeration and Air Conditioning Industry Association (JRA GL-02-1994 cooling water system - circulating type - make-up water).
 *3 ① Ambient temperature: 25°C, ② Circulating fluid temperature: 20°C, ③ Circulating fluid at the rated flow, ④ Circulating fluid: Tap water, ⑤ Power supply: 200 VAC, ⑥ Piping length: Shortest
 For models with an inverter pump mounted (Option T1), the cooling capacity will decrease by 300 W.
 *4 ① Ambient temperature: 25°C, ② Circulating fluid temperature: 20°C, ③ Circulating fluid at the rated flow, ④ Circulating fluid: Tap water, ⑤ Power supply: 200 VAC, ⑥ Piping length: Shortest
 *5 Temperature at the thermo-chiller outlet when the circulating fluid flow is at the rated flow and the circulating fluid outlet and return port are directly connected
 The installation environment and power supply are within the specification range and stable.
 *6 The capacity at the thermo-chiller outlet when the circulating fluid temperature is 20°C
 *7 The required flow rate for maintaining the cooling capacity or temperature stability
 The specification of the cooling capacity and the temperature stability may not be satisfied if the flow rate is lower than the rated flow.
 *8 Purchase an earth leakage breaker with a sensitivity current of 30 mA and a power supply of 200 VAC separately.

*9 Front: 1 m, height: 1 m, stable with no load, Other conditions → See *4.
 *10 Dimensions between panels, not including the dimensions of protrusion
 When Option Y (With feet/Without rack mounting brackets) is selected, refer to page 35.
 *11 Weight in the dry state without circulating fluids
 The weight will increase by 1 kg when Option DM (With electric conductivity control function, Applicable to DI water piping) is selected.
 The weight will increase by 2 kg when Option T1 (Inverter pump mounted) is selected.
 *12 Option M (Applicable to DI water piping) does not contain copper.
 *13 For Option DM (With electric conductivity control function, Applicable to DI water piping)
 *14 If the product is used at an altitude of 1000 m or higher, refer to "For altitudes of 1000 m or higher" on page 42.
 *15 No continuous voltage fluctuation
 *16 To be prepared by the customer
 *17 ① Ambient temperature: 25°C, ② Circulating fluid temperature: 20°C, ③ Circulating fluid at the rated flow, ④ Circulating fluid: Tap water, ⑤ Power supply: 200 VAC, ⑥ Piping length: Shortest, ⑦ With the rated cooling load applied
 *18 For Option DM (With electric conductivity control function, Applicable to DI water piping), a DI filter is included.
 For pipe thread type F, a G thread conversion fitting set is included.
 For pipe thread type N, an NPT thread conversion fitting set is included.
 *19 Not included for Option Z (Removed parts)
 *20 Not included for Options Z and Z1 (Removed parts)

Specifications: 200 to 230 VAC Water-cooled Refrigeration

Model		HRR010-W-20	
Cooling method		Water-cooled refrigeration	
Refrigerant		R410A (HFC)	
Refrigerant charge [kg]		0.15	
Control method		PID control	
Ambient temperature/Humidity/Altitude*1, 15		Temperature: 5 to 40°C, Humidity: 30 to 70%, Altitude: less than 3000 m	
Circulating fluid system	Circulating fluid*2	Tap water, 15% ethylene glycol aqueous solution	
	Set temperature range*1 [°C]	15 to 35	
	Cooling capacity (50/60 Hz)*3 [W]	1000/1100	
	Heating capacity (50/60 Hz)*4 [W]	200/200	
	Temperature stability*5 [°C]	±0.1	
	Pump capacity (50/60 Hz)*6 [MPa]	0.09 (at 5 L/min)/0.11 (at 5 L/min) For Option T1: 0.35 (at 5 L/min)/0.35 (at 5 L/min)	
	Rated flow (50/60 Hz)*7 [L/min]	5/5 For Option T1: 5/5	
	Flow display range*21 [L/min]	2 to 16	
	Electric conductivity display range [µS/cm]	0.1 to 48 (Only for Option DM)	
	Electric conductivity setting range [µS/cm]	0.5 to 45 (Only for Option DM)	
	Particle filter nominal filtration rating*20 [µm]	35	
	Bypass valve*20	Installed	
	Tank capacity [L]	Approx. 3	
	Outlet, Return port size	Rc1/2	
	Drain port size	Rc1/4, With cap	
Leakage protection	Drain pan (With water leakage sensor*20)		
Fluid contact material	Stainless steel, Copper (Heat exchanger brazing)*12, Alumina ceramic, Carbon, PP, PE, PPE, POM, PET, PA, FKM, EPDM, NBR, PVC, PPS, Fluoropolymer*13, Ion exchange resin*13		
Facility water system	Temperature range [°C]	5 to 35	
	Pressure range [MPa]	0.3 to 0.5	
	Required flow rate*14 [L/min]	6	
	Inlet-outlet pressure differential of facility water [MPa]	0.3 or more	
	Port size	Rc3/8	
	Fluid contact material	Stainless steel, Copper (Heat exchanger brazing), Bronze, Brass, Synthetic rubber	
Electrical system	Power supply	Single-phase 200 to 230 VAC, 50/60 Hz, Allowable voltage range ±10%*16	
	Circuit protector [A]	10	
	Applicable earth leakage breaker capacity*8	Rated current: 10 A Sensitivity current: 30 mA	
	Cable quantity x Size (Including grounding cable)*17	3 cores x 14 AWG (3 cores x 2.0 mm ²)	
	Rated operating current (50/60 Hz)*18 [A]		2.4/3.0 For Option T1 4.2/4.6
			0.47/0.59 (0.50/0.60) For Option T1 0.72/0.78 (0.84/0.93)
	Rated power consumption (50/60 Hz)*18 [kW (kVA)]		
Communication function	Contact input/output, Serial RS-485/RS-232C		
Noise level (50/60 Hz)*9 [dB(A)]	57/58		
Dimensions*10 [mm]	W 483 x D 550 x H 221		
Accessories*19	Power supply connector, Operation manual, Particle filter element*20		
Weight*11 [kg]	27		

*1 No condensation should be present. During seasons or in locations where the ambient temperature is likely to fall below freezing point, please contact SMC.

*2 If tap water is used, use water that is compliant with the Water Quality Standards of the Japan Refrigeration and Air Conditioning Industry Association (JRA GL-02-1994 cooling water system - circulating type - make-up water).

*3 ① Facility water temperature: 25°C, ② Circulating fluid temperature: 20°C, ③ Circulating fluid at the rated flow, ④ Circulating fluid: Tap water, ⑤ Power supply: 200 VAC, ⑥ Piping length: Shortest

For models with an inverter pump mounted (Option T1), the cooling capacity will decrease by 300 W.

*4 ① Ambient temperature: 25°C, ② Facility water temperature: 25°C, ③ Circulating fluid temperature: 20°C, ④ Circulating fluid at the rated flow, ⑤ Circulating fluid: Tap water, ⑥ Power supply: 200 VAC, ⑦ Piping length: Shortest

*5 Temperature at the thermo-chiller outlet when the circulating fluid flow is at the rated flow and the circulating fluid outlet and return port are directly connected. The installation environment and power supply are within the specification range and stable.

*6 The capacity at the thermo-chiller outlet when the circulating fluid temperature is 20°C

*7 The required flow rate for maintaining the cooling capacity or temperature stability

The specification of the cooling capacity and the temperature stability may not be satisfied if the flow rate is lower than the rated flow.

*8 Purchase an earth leakage breaker with a sensitivity current of 30 mA and a power supply of 200 VAC separately.

*9 Front: 1 m, height: 1 m, stable with no load, Other conditions → See *4.

*10 Dimensions between panels, not including the dimensions of protrusion. When Option Y (With feet/Without rack mounting brackets) is selected, refer to page 35.

*11 Weight in the dry state without circulating fluids and facility water (for water-cooled refrigeration)

The weight will increase by 1 kg when Option DM (With electric conductivity control function, Applicable to DI water piping) is selected.

The weight will increase by 2 kg when Option T1 (Inverter pump mounted) is selected.

*12 Option M (Applicable to DI water piping) does not contain copper.

*13 For Option DM (With electric conductivity control function, Applicable to DI water piping)

*14 The required flow rate when the cooling capacity load is applied under the conditions in *3

*15 If the product is used at an altitude of 1000 m or higher, refer to "For altitudes of 1000 m or higher" on page 42.

*16 No continuous voltage fluctuation

*17 To be prepared by the customer

*18 ① Facility water temperature: 25°C, ② Circulating fluid temperature: 20°C, ③ Circulating fluid at the rated flow, ④ Circulating fluid: Tap water, ⑤ Power supply: 200 VAC, ⑥ Piping length: Shortest, ⑦ With the rated cooling load applied

*19 For Option DM (With electric conductivity control function, Applicable to DI water piping), a DI filter is included.

For pipe thread type F, a G thread conversion fitting set is included. For pipe thread type N, an NPT thread conversion fitting set is included.

*20 Not included for Option Z (Removed parts)

*21 Not included for Options Z and Z1 (Removed parts)

Thermo-chiller/Rack Mount Type Single-phase 100/115 VAC

RoHS

HRR012/018



How to Order

Air-cooled Refrigeration

HRR 012 - A - 10 - U



Cooling capacity

012	1000/1200 W (50/60 Hz)
018	1600/1800 W (50/60 Hz)

Cooling method

A	Air-cooled refrigeration
---	--------------------------

Pipe thread type

Nil	Rc
F	G (With Rc-G conversion fitting set)
N	NPT (With Rc-NPT conversion fitting set)

Power supply

10	Single-phase 100 VAC (50/60 Hz) Single-phase 115 VAC (60 Hz)
----	---

Option 2 (p. 35)

Nil	None
Y	With feet/Without rack mounting brackets
Z*1	Without either a flow sensor, water leakage sensor, particle filter, bypass valve or retaining clip
Z1*1	Without either a flow sensor or retaining clip

*1 Only Option Z or Z1 can be selected.

Option 1 (pp. 32, 34)

Nil	None
DM	With electric conductivity control function, Applicable to DI water piping
M	Applicable to DI water piping
T	High-pressure pump mounted

· When multiple options are combined, indicate symbols in alphabetical order.

Water-cooled Refrigeration

HRR 012 - W - 10 - U



Cooling capacity

012	1000/1200 W (50/60 Hz)
018	1600/1800 W (50/60 Hz)

Cooling method

W	Water-cooled refrigeration
---	----------------------------

Pipe thread type

Nil	Rc
F	G (With Rc-G conversion fitting set)
N	NPT (With Rc-NPT conversion fitting set)

Power supply

10	Single-phase 100 VAC (50/60 Hz) Single-phase 115 VAC (60 Hz)
----	---

Option 2 (p. 35)

Nil	None
Y	With feet/Without rack mounting brackets
Z*1	Without either a flow sensor, water leakage sensor, particle filter, bypass valve or retaining clip
Z1*1	Without either a flow sensor or retaining clip

*1 Only Option Z or Z1 can be selected.

Option 1 (pp. 32, 34)

Nil	None
DM	With electric conductivity control function, Applicable to DI water piping
M	Applicable to DI water piping
T	High-pressure pump mounted

· When multiple options are combined, indicate symbols in alphabetical order.

HRR Series

Specifications: 100/115 VAC

Model		HRR012-A-10	HRR018-A-10	HRR012-W-10	HRR018-W-10	
Cooling method		Air-cooled refrigeration			Water-cooled refrigeration	
Refrigerant		R410A (HFC)				
Refrigerant charge	[kg]	0.36	0.36	0.25	0.25	
Control method		PID control				
Ambient temperature/Humidity/Altitude*1, 14		Temperature: 5 to 40°C, Humidity: 30 to 70%, Altitude: less than 3000 m				
Circulating fluid system	Circulating fluid*2	Tap water, 15% ethylene glycol aqueous solution				
	Set temperature range*1	[°C] 5 to 35				
	Cooling capacity (50/60 Hz)*3	[W] 1000/1200	1600/1800	1000/1200	1600/1800	
	Heating capacity (50/60 Hz)*4	[W] 400		500		
	Temperature stability*5	[°C] ±0.1				
	Pump capacity (50/60 Hz)*6	[MPa] 0.13 (at 7 L/min)/0.18 (at 7 L/min) For Options T, MT: 0.36 (at 7 L/min)/0.42 (at 10 L/min)				
	Rated flow (50/60 Hz)*7	[L/min] 7/7 For Options T, MT: 7/10				
	Flow display range*21	[L/min] 2 to 16				
	Electric conductivity display range	[µS/cm] 0.1 to 48 (Only for Option DM)				
	Electric conductivity setting range	[µS/cm] 0.5 to 45 (Only for Option DM)				
	Particle filter nominal filtration rating*20	[µm] 5				
	Bypass valve*20	Installed				
	Tank capacity	[L] Approx. 4				
	Outlet, Return port size	Rc1/2				
	Drain port size	Rc1/4, With cap				
Leakage protection	Drain pan (With water leakage sensor)*20					
Fluid contact material	Stainless steel, Copper (Heat exchanger brazing)*11, Bronze*17, SiC, Alumina ceramic, Carbon, PP, PE, POM, PA, FKM, EPDM, PVC, PPS, AS, Fluoropolymer*12, Ion exchange resin*12					
Facility water system	Temperature range	[°C] 5 to 40			5 to 40	
	Pressure range	[MPa] 0.3 to 0.5			0.3 to 0.5	
	Required flow rate (50/60 Hz)*13	[L/min] 8		12		
	Inlet-outlet pressure differential of facility water	[MPa] 0.3 or more				
	Port size	Rc3/8				
Fluid contact material	Stainless steel, Copper (Heat exchanger brazing), Bronze, Synthetic rubber					
Electrical system	Power supply	Single-phase 100 VAC (50/60 Hz), 115 VAC (60 Hz) Allowable voltage range ±10%*15				
	Circuit protector	[A] 15				
	Applicable earth leakage breaker capacity*8	Rated current: 15 A, Sensitivity current: 30 mA				
	Cable quantity x Size (Including grounding cable)*16	3 cores x 14 AWG (3 cores x 2.0 mm ²)				
	Rated operating current*18 (50/60 Hz)	[A]	8.9/8.9	9.1/9.6	8.5/8.5	8.7/8.7
			For Options T, MT			
	Rated power consumption*18 (50/60 Hz)	[kW (kVA)]	10.7/10.7	11.0/11.0	10.5/10.5	10.8/10.8
0.8/0.9 (1.0/1.0)			0.9/1.1 (1.1/1.1)	0.7/0.8 (0.9/0.9)	0.8/0.9 (1.0/1.0)	
		For Options T, MT				
		0.9/1.1 (1.1/1.1)	1.0/1.3 (1.2/1.3)	0.9/1.0 (1.1/1.0)	1.1/1.1 (1.2/1.1)	
Communication function	Contact input/output, Serial RS-485/RS-232C					
Noise level (50/60 Hz)*9	[dB]	59/60	59/60	59/60	59/60	
Accessories*19	Power supply connector, Particle filter element and maintenance handle*20, Operation manual					
Weight*10	[kg]	41		40		

- *1 No condensation should be present. During seasons or in locations where the ambient temperature is likely to fall below freezing point, please contact SMC. Use 15% ethylene glycol aqueous solution when operating at a temperature of 10°C or less.
- *2 If tap water is used, use water that is compliant with the Water Quality Standards of the Japan Refrigeration and Air Conditioning Industry Association (JRA GL-02-1994 cooling water system - circulating type - make-up water).
- *3 ① Ambient temperature: 25°C, ② Facility water temperature: 25°C, ③ Circulating fluid temperature: 20°C, ④ Circulating fluid at the rated flow, ⑤ Circulating fluid: Tap water, ⑥ Power supply: 100 VAC, ⑦ Piping length: Shortest
For models with a high-pressure pump mounted (Options T, MT), the cooling capacity will decrease by 300 W.
- *4 ① Ambient temperature: 25°C, ② Facility water temperature: 25°C, ③ Circulating fluid temperature: 20°C, ④ Circulating fluid at the rated flow, ⑤ Circulating fluid: Tap water, ⑥ Power supply: 100 VAC, ⑦ Piping length: Shortest
- *5 Temperature at the thermo-chiller outlet when the circulating fluid flow is at the rated flow and the circulating fluid outlet and return port are directly connected. The installation environment and power supply are within the specification range and stable.
- *6 The capacity at the thermo-chiller outlet when the circulating fluid temperature is 20°C
- *7 The required flow rate for maintaining the cooling capacity or temperature stability
The specification of the cooling capacity and the temperature stability may not be satisfied if the flow rate is lower than the rated flow.
- *8 Purchase an earth leakage breaker with a sensitivity current of 30 mA and a power supply of 100 VAC separately.

- *9 Front: 1 m, height: 1 m, stable with no load, Other conditions → See *4.
- *10 Weight in the dry state without circulating fluids and facility water (for water-cooled refrigeration)
The weight will increase by 1 kg when Option DM (With electric conductivity control function, Applicable to DI water piping) is selected.
The weight will increase by 5 kg when Options T (High-pressure pump mounted) or MT (Applicable to DI water piping + High-pressure pump mounted) are selected.
The weight will decrease by 1 kg for Option Z (Removed parts).
- *11 Options M (Applicable to DI water piping) and MT (Applicable to DI water piping + High-pressure pump mounted) do not contain copper or bronze.
- *12 For Option DM (With electric conductivity control function, Applicable to DI water piping)
- *13 The required flow rate when the cooling capacity load is applied under the conditions in *3
- *14 If the product is used at an altitude of 1000 m or higher, refer to "For altitudes of 1000 m or higher" on page 42.
- *15 No continuous voltage fluctuation
- *16 To be prepared by the customer
- *17 Option T (High-pressure pump mounted) contains this material.
- *18 ① Ambient temperature: 25°C, ② Facility water temperature: 25°C, ③ Circulating fluid temperature: 20°C, ④ Circulating fluid at the rated flow, ⑤ Circulating fluid: Tap water, ⑥ Power supply: 100 VAC, ⑦ Piping length: Shortest, ⑧ With the rated cooling load applied
- *19 For Option DM (With electric conductivity control function, Applicable to DI water piping), a DI filter is included.
For pipe thread type F, a G thread conversion fitting set is included.
For pipe thread type N, an NPT thread conversion fitting set is included.
- *20 Not included for Option Z (Removed parts)
- *21 Not included for Options Z and Z1 (Removed parts)

Thermo-chiller/Rack Mount Type Single-phase 200 to 230 VAC

RoHS

HRR012/018/024/030



How to Order

Air-cooled Refrigeration

HRR **012** - **A** - **20** -

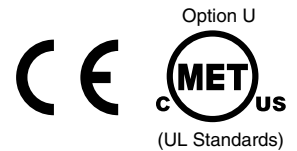

Cooling capacity

012	1000/1200 W (50/60 Hz)
018	1600/1800 W (50/60 Hz)
024	2000/2400 W (50/60 Hz)
030	2500/3000 W (50/60 Hz)

Cooling method

A	Air-cooled refrigeration
----------	--------------------------

Pipe thread type

Nil	Rc
F	G (With Rc-G conversion fitting set)
N	NPT (With Rc-NPT conversion fitting set)

Power supply

20	Single-phase 200 to 230 VAC (50/60 Hz)
-----------	--

Option (pp. 32, 34, 35)

Nil	None
DM	With electric conductivity control function, Applicable to DI water piping
M	Applicable to DI water piping
T ^{*1}	High-pressure pump mounted
T1 ^{*1}	Inverter pump mounted (Pending for UL)
U	Compliant with UL Standards
Y	With feet/Without rack mounting brackets
Z ^{*2}	Without either a flow sensor, water leakage sensor, particle filter, bypass valve or retaining clip
Z1 ^{*2}	Without either a flow sensor or retaining clip

*1 Only Option T or T1 can be selected.

*2 Only Option Z or Z1 can be selected.

· When multiple options are combined, indicate symbols in alphabetical order.

Water-cooled Refrigeration

HRR **012** - **W** - **20** - **U**



Cooling capacity

012	1000/1200 W (50/60 Hz)
018	1600/1800 W (50/60 Hz)
024	2000/2400 W (50/60 Hz)
030	2500/3000 W (50/60 Hz)

Cooling method

W	Water-cooled refrigeration
----------	----------------------------

Pipe thread type

Nil	Rc
F	G (With Rc-G conversion fitting set)
N	NPT (With Rc-NPT conversion fitting set)

Power supply

20	Single-phase 200 to 230 VAC (50/60 Hz)
-----------	--

Option 2 (p. 35)

Nil	None
Y	With feet/Without rack mounting brackets
Z ^{*2}	Without either a flow sensor, water leakage sensor, particle filter, bypass valve or retaining clip
Z1 ^{*2}	Without either a flow sensor or retaining clip

*2 Only Option Z or Z1 can be selected.

Option 1 (pp. 32, 34)

Nil	None
DM	With electric conductivity control function, Applicable to DI water piping
M	Applicable to DI water piping
T ^{*1}	High-pressure pump mounted
T1 ^{*1}	Inverter pump mounted (Pending for UL)

*1 Only Option T or T1 can be selected.

· When multiple options are combined, indicate symbols in alphabetical order.

Specifications: 200 to 230 VAC Air-cooled Refrigeration

Model	HRR012-A-20	HRR018-A-20	HRR024-A-20	HRR030-A-20
Cooling method	Air-cooled refrigeration			
Refrigerant	R410A (HFC)			
Refrigerant charge [kg]	0.38		0.47	
Control method	PID control			
Ambient temperature/Humidity/Altitude *1, 13	Temperature: 5 to 40°C, Humidity: 30 to 70%, Altitude: less than 3000 m			
Circulating fluid *2	Tap water, 15% ethylene glycol aqueous solution			
Set temperature range *1 [°C]	5 to 35			
Cooling capacity (50/60 Hz) *3 [W]	1000/1200	1600/1800	2000/2400	2500/3000
Heating capacity (50/60 Hz) *4 [W]	450/500		550/700	
Temperature stability *5 [°C]	±0.1			
Pump capacity (50/60 Hz) *6 [MPa]	0.13 (at 7 L/min)/0.18 (at 7 L/min) For Option T: 0.42 (at 10 L/min)/0.4 (at 14 L/min) For Option MT: 0.32 (at 10 L/min)/0.32 (at 14 L/min) For Option T1: 0.28 (at 10 L/min)/0.28 (at 10 L/min)			
Rated flow (50/60 Hz) *7 [L/min]	7/7 For Options T, MT: 10/14, For Option T1: 10/10			
Flow display range *20 [L/min]	2 to 16			
Electric conductivity display range [µS/cm]	0.1 to 48 (Only for Option DM)			
Electric conductivity setting range [µS/cm]	0.5 to 45 (Only for Option DM)			
Particle filter nominal filtration rating *19 [µm]	5			
Bypass valve *19	Installed			
Tank capacity [L]	Approx. 4			
Outlet, Return port size	Rc1/2			
Drain port size	Rc1/4, With cap			
Leakage protection	Drain pan (With water leakage sensor*19)			
Fluid contact material	Stainless steel, Copper (Heat exchanger brazing)*11, Bronze*16, SiC, Alumina ceramic, Carbon, PP, PE, POM, PA, FKM, EPDM, PVC, PPS, AS, Fluoropolymer*12, Ion exchange resin*12			
Power supply	Single-phase 200 to 230 VAC, 50/60 Hz, Allowable voltage range ±10%*14			
Circuit protector [A]	10 For Options T, MT: 15			
Applicable earth leakage breaker capacity *8	Rated current: 10 A For Options T, MT: 15 A Sensitivity current: 30 mA			
Cable quantity x Size (Including grounding cable) *15	3 cores x 14 AWG (3 cores x 2.0 mm ²)			
Rated operating current (50/60 Hz) *17 [A]	3.6/4.0	3.6/4.3	5.2/5.8	5.5/6.2
	For Options T, MT			
	4.7/6.2	4.7/6.5	6.3/8.0	6.5/8.3
	For Option T1			
Rated power consumption (50/60 Hz) *17 [kW (kVA)]	0.6/0.8 (0.7/0.8)	0.7/0.9 (0.7/0.9)	0.9/1.2 (1.1/1.2)	1.0/1.2 (1.1/1.3)
	For Options T, MT			
	0.9/1.2 (0.9/1.2)	0.9/1.3 (1.0/1.3)	1.2/1.6 (1.3/1.6)	1.3/1.6 (1.3/1.7)
	For Option T1			
	0.9/1.0 (1.0/1.2)	0.9/1.0 (1.1/1.2)	1.2/1.2 (1.3/1.4)	1.2/1.3 (1.3/1.5)
Communication function	Contact input/output, Serial RS-485/RS-232C			
Noise level (50/60 Hz) *9 [dB]	59/60	59/60	61/64	61/64
Accessories *18	Power supply connector, Particle filter element and maintenance handle*19, Operation manual			
Weight *10 [kg]	40		46	

*1 No condensation should be present. During seasons or in locations where the ambient temperature is likely to fall below freezing point, please contact SMC. Use 15% ethylene glycol aqueous solution when operating at a temperature of 10°C or less.

*2 If tap water is used, use water that is compliant with the Water Quality Standards of the Japan Refrigeration and Air Conditioning Industry Association (JRA GL-02-1994 cooling water system - circulating type - make-up water).

*3 ① Ambient temperature: 25°C, ② Circulating fluid temperature: 20°C, ③ Circulating fluid at the rated flow, ④ Circulating fluid: Tap water, ⑤ Power supply: 200 VAC, ⑥ Piping length: Shortest
For Options "T," "MT" (high-pressure pump mounted type), and "T1" (inverter pump mounted type), the cooling capacity will decrease by approx. 300 W.

*4 ① Ambient temperature: 25°C, ② Circulating fluid temperature: 20°C, ③ Circulating fluid at the rated flow, ④ Circulating fluid: Tap water, ⑤ Power supply: 200 VAC, ⑥ Piping length: Shortest

*5 Temperature at the thermo-chiller outlet when the circulating fluid flow is at the rated flow and the circulating fluid outlet and return port are directly connected
The installation environment and power supply are within the specification range and stable.

*6 The capacity at the thermo-chiller outlet when the circulating fluid temperature is 20°C

*7 The required flow rate for maintaining the cooling capacity or temperature stability
The specification of the cooling capacity and the temperature stability may not be satisfied if the flow rate is lower than the rated flow.

*8 Purchase an earth leakage breaker with a sensitivity current of 30 mA and a power supply of 200 VAC separately.

*9 Front: 1 m, height: 1 m, stable with no load, Other conditions → See *4.

*10 Weight in the dry state without circulating fluids
The weight will increase by 1 kg when Option DM (With electric conductivity control function, Applicable to DI water piping) is selected.
The weight will increase by 5 kg when Options T (High-pressure pump mounted) or MT (Applicable to DI water piping + High-pressure pump mounted) are selected.

The weight will increase by 1 kg when Options T1 (Inverter pump mounted) or Z (Removed parts) are selected.

*11 Options M (Applicable to DI water piping) and MT (Applicable to DI water piping + High-pressure pump mounted) do not contain copper or bronze.

*12 For Option DM (With electric conductivity control function, Applicable to DI water piping)

*13 If the product is used at an altitude of 1000 m or higher, refer to "For altitudes of 1000 m or higher" on page 42.

*14 No continuous voltage fluctuation

*15 To be prepared by the customer

*16 Option T (High-pressure pump mounted) contains this material.

*17 ① Ambient temperature: 25°C, ② Circulating fluid temperature: 20°C,

③ Circulating fluid at the rated flow, ④ Circulating fluid: Tap water, ⑤

Power supply: 200 VAC, ⑥ Piping length: Shortest, ⑦ With the rated

cooling load applied

*18 For Option DM (With electric conductivity control function, Applicable to DI water piping), a DI filter is included.

For pipe thread type F, a G thread conversion fitting set is included.

For pipe thread type N, an NPT thread conversion fitting set is included.

*19 Not included for Option Z (Removed parts)

*20 Not included for Options Z and Z1 (Removed parts)

Specifications: 200 to 230 VAC Water-cooled Refrigeration

Model	HRR012-W-20	HRR018-W-20	HRR024-W-20	HRR030-W-20
Cooling method	Water-cooled refrigeration			
Refrigerant	R410A (HFC)			
Refrigerant charge [kg]	0.25		0.40	
Control method	PID control			
Ambient temperature/Humidity/Altitude*1, 14	Temperature: 5 to 40°C, Humidity: 30 to 70%, Altitude: less than 3000 m			
Circulating fluid*2	Tap water, 15% ethylene glycol aqueous solution			
Set temperature range*1 [°C]	5 to 35			
Cooling capacity (50/60 Hz)*3 [W]	1000/1200	1600/1800	2000/2400	2500/3000
Heating capacity (50/60 Hz)*4 [W]	450/500		550/700	
Temperature stability*5 [°C]	±0.1			
Pump capacity (50/60 Hz)*6 [MPa]	0.13 (at 7 L/min)/0.18 (at 7 L/min) For Option T: 0.42 (at 10 L/min)/0.4 (at 14 L/min) For Option MT: 0.32 (at 10 L/min)/0.32 (at 14 L/min) For Option T1: 0.28 (at 10 L/min)/0.28 (at 10 L/min)			
Rated flow (50/60 Hz)*7 [L/min]	7/7 For Options T, MT: 10/14, For Option T1: 10/10			
Flow display range*21 [L/min]	2 to 16			
Electric conductivity display range [µS/cm]	0.1 to 48 (Only for Option DM)			
Electric conductivity setting range [µS/cm]	0.5 to 45 (Only for Option DM)			
Particle filter nominal filtration rating*20 [µm]	5			
Bypass valve*20	Installed			
Tank capacity [L]	Approx. 4			
Outlet, Return port size	Rc1/2			
Drain port size	Rc1/4, With cap			
Leakage protection	Drain pan (With water leakage sensor*20)			
Fluid contact material	Stainless steel, Copper (Heat exchanger brazing)*11, Bronze*17, SiC, Alumina ceramic, Carbon, PP, PE, POM, PA, FKM, EPDM, PVC, PPS, AS, Fluoropolymer*12, Ion exchange resin*12			
Temperature range [°C]	5 to 40			
Pressure range [MPa]	0.3 to 0.5			
Required flow rate (50/60 Hz)*13 [L/min]	8	12	14	15
Inlet-outlet pressure differential of facility water [MPa]	0.3 or more			
Port size	Rc3/8			
Fluid contact material	Stainless steel, Copper (Heat exchanger brazing), Bronze, Brass, Synthetic rubber			
Power supply	Single-phase 200 to 230 VAC, 50/60 Hz, Allowable voltage range ±10%*15			
Circuit protector [A]	10 For Options T, MT: 15			
Applicable earth leakage breaker capacity*8	Rated current: 10 A For Options T, MT: 15 A Sensitivity current: 30 mA			
Cable quantity x Size (Including grounding cable)*16	3 cores x 14 AWG (3 cores x 2.0 mm ²)			
Rated operating current (50/60 Hz)*18 [A]	3.2/3.6	3.3/3.6	4.9/5.1	4.9/5.2
	For Options T, MT			
	4.3/5.8	4.4/5.8	6.0/7.3	6.0/7.4
Rated power consumption (50/60 Hz)*18 [kW (kVA)]	For Option T1			
	5.0/5.2	5.0/5.2	5.9/6.0	5.9/6.1
	0.6/0.7 (0.7/0.7)	0.6/0.7 (0.7/0.7)	0.8/1.0 (1.0/1.0)	0.8/1.0 (1.0/1.0)
Communication function	Contact input/output, Serial RS-485/RS-232C			
	For Options T, MT			
	0.9/1.1 (0.9/1.2)	0.9/1.1 (0.9/1.2)	1.1/1.2 (1.4/1.4)	1.1/1.2 (1.4/1.4)
Noise level (50/60 Hz)*9 [dB]	For Option T1			
	0.9/1.0 (1.0/1.1)	0.9/1.0 (1.0/1.1)	1.0/1.1 (1.2/1.2)	1.0/1.1 (1.2/1.2)
Accessories*19	Power supply connector, Particle filter element and maintenance handle*20, Operation manual			
Weight*10 [kg]	41		45	

- *1 No condensation should be present. During seasons or in locations where the ambient temperature is likely to fall below freezing point, please contact SMC. Use 15% ethylene glycol aqueous solution when operating at a temperature of 10°C or less.
- *2 If tap water is used, use water that is compliant with the Water Quality Standards of the Japan Refrigeration and Air Conditioning Industry Association (JRA GL-02-1994 cooling water system - circulating type - make-up water).
- *3 ① Facility water temperature: 25°C, ② Circulating fluid temperature: 20°C, ③ Circulating fluid at the rated flow, ④ Circulating fluid: Tap water, ⑤ Power supply: 200 VAC, ⑥ Piping length: Shortest
For Options "T," "MT" (high-pressure pump mounted type), and "T1" (inverter pump mounted type), the cooling capacity will decrease by approx. 300 W.
- *4 ① Ambient temperature: 25°C, ② Facility water temperature: 25°C, ③ Circulating fluid temperature: 20°C, ④ Circulating fluid at the rated flow, ⑤ Circulating fluid: Tap water, ⑥ Power supply: 200 VAC, ⑦ Piping length: Shortest
- *5 Temperature at the thermo-chiller outlet when the circulating fluid flow is at the rated flow and the circulating fluid outlet and return port are directly connected
The installation environment and power supply are within the specification range and stable.
- *6 The capacity at the thermo-chiller outlet when the circulating fluid temperature is 20°C
- *7 The required flow rate for maintaining the cooling capacity or temperature stability
The specification of the cooling capacity and the temperature stability may not be satisfied if the flow rate is lower than the rated flow.
- *8 Purchase an earth leakage breaker with a sensitivity current of 30 mA and a power supply of 200 VAC separately.
- *9 Front: 1 m, height: 1 m, stable with no load, Other conditions → See *4.
- *10 Weight in the dry state without circulating fluids and facility water (for water-cooled refrigeration)
The weight will increase by 1 kg when Option DM (With electric conductivity control function, Applicable to DI water piping) is selected.
The weight will increase by 5 kg when Options T (High-pressure pump mounted) or MT (Applicable to DI water piping + High-pressure pump mounted) are selected.
The weight will increase by 1 kg when Options T1 (Inverter pump mounted) or Z (Removed parts) are selected.
- *11 Options M (Applicable to DI water piping) and MT (Applicable to DI water piping + High-pressure pump mounted) do not contain copper or bronze.
- *12 For Option DM (With electric conductivity control function, Applicable to DI water piping)
- *13 The required flow rate when the cooling capacity load is applied under the conditions in *3
- *14 If the product is used at an altitude of 1000 m or higher, refer to "For altitudes of 1000 m or higher" on page 42.
- *15 No continuous voltage fluctuation
- *16 To be prepared by the customer
- *17 Option T (High-pressure pump mounted) contains this material.
- *18 ① Facility water temperature: 25°C, ② Circulating fluid temperature: 20°C, ③ Circulating fluid at the rated flow, ④ Circulating fluid: Tap water, ⑤ Power supply: 200 VAC, ⑥ Piping length: Shortest, ⑦ With the rated cooling load applied
- *19 For Option DM (With electric conductivity control function, Applicable to DI water piping), a DI filter is included.
For pipe thread type F, a G thread conversion fitting set is included.
For pipe thread type N, an NPT thread conversion fitting set is included.
- *20 Not included for Option Z (Removed parts)
- *21 Not included for Options Z and Z1 (Removed parts)

Thermo-chiller/Rack Mount Type Single-phase 200 to 230 VAC

RoHS

HRR050

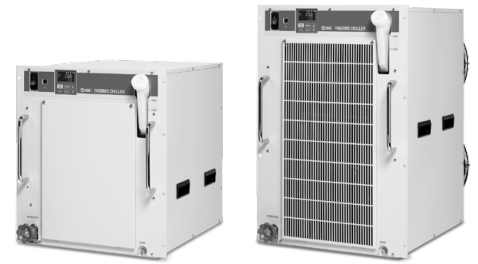

Water-cooled refrigeration Air-cooled refrigeration

How to Order

Air-cooled Refrigeration

HRR 050 - A [] - 20 - [] U []

Cooling capacity

050	4600/5100 W (50/60 Hz)
-----	------------------------

Cooling method

A	Air-cooled refrigeration
---	--------------------------

Pipe thread type

Nil	Rc
F	G (With Rc-G conversion fitting set)
N	NPT (With Rc-NPT conversion fitting set)

Power supply

20	Single-phase 200 to 230 VAC (50/60 Hz)
----	--

Option 2 (p. 35)

Nil	None
Y	With feet/Without rack mounting brackets
Z*1	Without either a flow sensor, water leakage sensor, particle filter, or bypass valve
Z1*1	Without a flow sensor

*1 Only Option Z or Z1 can be selected.

Option 1 (p. 32)

Nil	None
DM	With electric conductivity control function, Applicable to DI water piping
M	Applicable to DI water piping

· When multiple options are combined, indicate symbols in alphabetical order.

CE **MET** **US**
(UL Standards)

Water-cooled Refrigeration

HRR 050 - W [] - 20 - [] U []

Cooling capacity

050	5000/5900 W (50/60 Hz)
-----	------------------------

Cooling method

W	Water-cooled refrigeration
---	----------------------------

Pipe thread type

Nil	Rc
F	G (With Rc-G conversion fitting set)
N	NPT (With Rc-NPT conversion fitting set)

Power supply

20	Single-phase 200 to 230 VAC (50/60 Hz)
----	--

Option 2 (p. 35)

Nil	None
Y	With feet/Without rack mounting brackets
Z*1	Without either a flow sensor, water leakage sensor, particle filter, or bypass valve
Z1*1	Without a flow sensor

*1 Only Option Z or Z1 can be selected.

Option 1 (p. 32)

Nil	None
DM	With electric conductivity control function, Applicable to DI water piping
M	Applicable to DI water piping

· When multiple options are combined, indicate symbols in alphabetical order.

CE **MET** **US**
(UL Standards)

Specifications: 200 to 230 VAC Air-cooled Refrigeration

Model	HRR050-A-20-(DM)U(YZ)	
Cooling method	Air-cooled refrigeration	
Refrigerant	R410A (HFC)	
Refrigerant charge	[kg]	0.72
Control method	PID control	
Ambient temperature/Humidity/Altitude ^{*1, 13}	Temperature: 5 to 40°C, Humidity: 30 to 70%, Altitude: less than 3000 m	
Circulating fluid system	Circulating fluid ^{*2}	Tap water, 15% ethylene glycol aqueous solution
	Set temperature range ^{*1}	[°C] 5 to 35
	Cooling capacity (50/60 Hz) ^{*3}	[W] 4600/5100
	Heating capacity (50/60 Hz) ^{*3}	[W] 1000/1200
	Temperature stability ^{*4}	[°C] ±0.1
	Pump capacity (50/60 Hz) ^{*5}	[MPa] 0.34 (at 15 L/min)/0.34 (at 23 L/min)
	Rated flow (50/60 Hz) ^{*6}	[L/min] 15/23
	Flow display range ^{*19}	[L/min] 5 to 40
	Electric conductivity display range	[µS/cm] 0.1 to 48 (Only for Option DM)
	Electric conductivity setting range	[µS/cm] 0.5 to 45 (Only for Option DM)
	Particle filter nominal filtration rating ^{*18}	[µm] 5
	Bypass valve ^{*18}	Installed
	Tank capacity	[L] Approx. 5
	Outlet, Return port size	Rc1/2
	Drain port size	Rc1/4, With cap
	Leakage protection	Drain pan (With water leakage sensor ^{*18})
Fluid contact material	Stainless steel, Copper (Heat exchanger brazing) ^{*11} , Bronze ^{*11} , SiC, Alumina ceramic, Carbon, PP, PE, POM, PA, FKM, EPDM, PVC, PPS, AS, Fluoropolymer ^{*12} , Ion exchange resin ^{*12}	
Electrical system	Power supply	Single-phase 200 to 230 VAC, 50/60 Hz, Allowable voltage range ±10% ^{*14}
	Circuit protector	[A] 20
	Applicable earth leakage breaker capacity ^{*7}	Rated current: 20 A Sensitivity current: 30 mA
	Cable quantity x Size (Including grounding cable) ^{*15}	3 cores x 12 AWG (3 cores x 3.5 mm ²)
	Rated operating current (50/60 Hz) ^{*16}	[A] 9.3/11.8
	Rated power consumption (50/60 Hz) ^{*16}	[kW (kVA)] 1.9/2.4 (1.9/2.5)
Communication function	Contact input/output, Serial RS-485/RS-232C	
Noise level (50/60 Hz) ^{*8}	[dB(A)] 63/67	
Dimensions ^{*9}	[mm] W 483 x D 550 x H 710	
Accessories ^{*17}	Power supply connector, Maintenance handle for particle filter ^{*18} , Operation manual, Particle filter element ^{*18}	
Weight ^{*10}	[kg] 74	

*1 No condensation should be present. During seasons or in locations where the ambient temperature is likely to fall below freezing point, please contact SMC.

*2 If tap water is used, use water that is compliant with the Water Quality Standards of the Japan Refrigeration and Air Conditioning Industry Association (JRA GL-02-1994 cooling water system - circulating type - make-up water).

*3 ① Ambient temperature: 25°C, ② Circulating fluid temperature: 20°C, ⑤ Circulating fluid at the rated flow, ⑥ Circulating fluid: Tap water, ⑦ Power supply: 200 VAC, ⑧ Piping length: Shortest

*4 Temperature at the thermo-chiller outlet when the circulating fluid flow is at the rated flow and the circulating fluid outlet and return port are directly connected
The installation environment and power supply are within the specification range and stable.

*5 The capacity at the thermo-chiller outlet when the circulating fluid temperature is 20°C

*6 The required flow rate for maintaining the cooling capacity or temperature stability
The specification of the cooling capacity and the temperature stability may not be satisfied if the flow rate is lower than the rated flow.

*7 Purchase an earth leakage breaker with a sensitivity current of 30 mA and a power supply of 200 VAC separately.

*8 Front: 1 m, height: 1 m, stable with no load, Other conditions → See *3.

*9 Dimensions between panels, not including the dimensions of protrusion
When Option Y (With feet/Without rack mounting brackets) is selected, refer to page 35.

*10 Weight in the dry state without circulating fluids
The weight will increase by 1 kg when Option DM (With electric conductivity control function, Applicable to DI water piping) is selected.
The weight will decrease by 2 kg for Option Z (Removed parts).

*11 Options M (Applicable to DI water piping) and DM (With electric conductivity control function, Applicable to DI water piping) do not contain copper or bronze.

*12 For Option DM (With electric conductivity control function, Applicable to DI water piping)

*13 If the product is used at an altitude of 1000 m or higher, refer to "For altitudes of 1000 m or higher" on page 42.

*14 No continuous voltage fluctuation

*15 To be prepared by the customer

*16 ① Ambient temperature: 25°C, ② Circulating fluid temperature: 20°C, ③ Circulating fluid at the rated flow, ④ Circulating fluid: Tap water, ⑤ Power supply: 200 VAC, ⑥ Piping length: Shortest, ⑦ With the rated cooling load applied

*17 For Option DM (With electric conductivity control function, Applicable to DI water piping), a DI filter is included.
For pipe thread type F, a G thread conversion fitting set is included.
For pipe thread type N, an NPT thread conversion fitting set is included.

*18 Not included for Option Z (Removed parts)

*19 Not included for Options Z and Z1 (Removed parts)

Specifications: 200 to 230 VAC **Water-cooled Refrigeration**

Model	HRR050-W-20-(DM)U(YZ)		
Cooling method	Water-cooled refrigeration		
Refrigerant	R410A (HFC)		
Refrigerant charge	[kg]	0.59	
Control method	PID control		
Ambient temperature/Humidity/Altitude*1, 14	Temperature: 5 to 40°C, Humidity: 30 to 70%, Altitude: less than 3000 m		
Circulating fluid system	Circulating fluid*2	Tap water, 15% ethylene glycol aqueous solution	
	Set temperature range*1	[°C] 5 to 35	
	Cooling capacity (50/60 Hz)*3	[W] 5000/5900	
	Heating capacity (50/60 Hz)*3	[W] 1000/1200	
	Temperature stability*4	[°C] ±0.1	
	Pump capacity (50/60 Hz)*5	[MPa] 0.34 (at 15 L/min)/0.34 (at 23 L/min)	
	Rated flow (50/60 Hz)*6	[L/min] 15/23	
	Flow display range*20	[L/min] 5 to 40	
	Electric conductivity display range	[µS/cm] 0.1 to 48 (Only for Option DM)	
	Electric conductivity setting range	[µS/cm] 0.5 to 45 (Only for Option DM)	
	Particle filter nominal filtration rating*19	[µm] 5	
	Bypass valve*19	Installed	
	Tank capacity	[L] Approx. 5	
	Outlet, Return port size	Rc1/2	
	Drain port size	Rc1/4, With cap	
Leakage protection	Drain pan (With water leakage sensor*19)		
Fluid contact material	Stainless steel, Copper (Heat exchanger brazing)*11, Bronze*11, SiC, Alumina ceramic, Carbon, PP, PE, POM, PA, FKM, EPDM, PVC, PPS, AS, Fluoropolymer*12, Ion exchange resin*12		
Facility water system	Temperature range	[°C] 5 to 40	
	Pressure range	[MPa] 0.3 to 0.5	
	Required flow rate*13	[L/min] 16	
	Inlet-outlet pressure differential of facility water	[MPa] 0.3 or more	
	Port size	Rc3/8	
	Fluid contact material	Stainless steel, Copper (Heat exchanger brazing), Bronze, Brass, Synthetic rubber	
Electrical system	Power supply	Single-phase 200 to 230 VAC, 50/60 Hz, Allowable voltage range ±10%*15	
	Circuit protector	[A] 20	
	Applicable earth leakage breaker capacity*7	Rated current: 20 A Sensitivity current: 30 mA	
	Cable quantity x Size (Including grounding cable)*16	3 cores x 12 AWG (3 cores x 3.5 mm ²)	
	Rated operating current (50/60 Hz)*17	[A] 8.5/11.0	
	Rated power consumption (50/60 Hz)*17	[kW (kVA)] 1.7/2.2 (1.7/2.3)	
Communication function	Contact input/output, Serial RS-485/RS-232C		
Noise level (50/60 Hz)*8	[dB(A)] 63/67		
Dimensions*9	[mm] W 483 x D 550 x H 532		
Accessories*18	Power supply connector, Maintenance handle for particle filter*19, Operation manual, Particle filter element*19		
Weight*10	[kg] 64		

- *1 No condensation should be present. During seasons or in locations where the ambient temperature is likely to fall below freezing point, please contact SMC.
- *2 If tap water is used, use water that is compliant with the Water Quality Standards of the Japan Refrigeration and Air Conditioning Industry Association (JRA GL-02-1994 cooling water system - circulating type - make-up water).
- *3 ① Facility water temperature: 25°C, ② Circulating fluid temperature: 20°C, ③ Circulating fluid at the rated flow, ④ Circulating fluid: Tap water, ⑤ Power supply: 200 VAC, ⑥ Piping length: Shortest
- *4 Temperature at the thermo-chiller outlet when the circulating fluid flow is at the rated flow and the circulating fluid outlet and return port are directly connected. The installation environment and power supply are within the specification range and stable.
- *5 The capacity at the thermo-chiller outlet when the circulating fluid temperature is 20°C
- *6 The required flow rate for maintaining the cooling capacity or temperature stability. The specification of the cooling capacity and the temperature stability may not be satisfied if the flow rate is lower than the rated flow.
- *7 Purchase an earth leakage breaker with a sensitivity current of 30 mA and a power supply of 200 VAC separately.
- *8 Front: 1 m, height: 1 m, stable with no load, Other conditions → See *3.
- *9 Dimensions between panels, not including the dimensions of protrusion. When Option Y (With feet/Without rack mounting brackets) is selected, refer to page 35.

- *10 Weight in the dry state without circulating fluids. The weight will increase by 1 kg when Option DM (With electric conductivity control function, Applicable to DI water piping) is selected. The weight will decrease by 2 kg for Option Z (Removed parts).
- *11 Option M (Applicable to DI water piping) does not contain copper or bronze.
- *12 For Option DM (With electric conductivity control function, Applicable to DI water piping)
- *13 The required flow rate when the cooling capacity load is applied under the conditions in *3
- *14 If the product is used at an altitude of 1000 m or higher, refer to "For altitudes of 1000 m or higher" on page 42.
- *15 No continuous voltage fluctuation
- *16 To be prepared by the customer
- *17 ① Facility water temperature: 25°C, ② Circulating fluid temperature: 20°C, ③ Circulating fluid at the rated flow, ④ Circulating fluid: Tap water, ⑤ Power supply: 200 VAC, ⑥ Piping length: Shortest, ⑦ With the rated cooling load applied
- *18 For Option DM (With electric conductivity control function, Applicable to DI water piping), a DI filter is included. For pipe thread type F, a G thread conversion fitting set is included. For pipe thread type N, an NPT thread conversion fitting set is included.
- *19 Not included for Option Z (Removed parts)
- *20 Not included for Options Z and Z1 (Removed parts)

Thermo-chiller/Rack Mount Type

3-phase 380 to 415 VAC/3-phase 460 to 480 VAC

HRR050



How to Order

Air-cooled Refrigeration

HRR 050 - A [] - 40 - [] T1 U []



Cooling capacity
050 4800/5800 W (50/60 Hz)

Cooling method
A Air-cooled refrigeration

Pipe thread type

Nil	Rc
F	G (With Rc-G conversion fitting set)
N	NPT (With Rc-NPT conversion fitting set)

Power supply
40 3-phase 380 to 415 VAC (50/60 Hz)
 3-phase 460 to 480 VAC (60 Hz)

Option 3 (p. 35)

Nil	None
Y	With feet/Without rack mounting brackets
Z	Without either a flow sensor, bypass valve, particle filter or water leakage sensor
Z1	Without a flow sensor

Option 2 (pp. 33, 33-1)

T1	Inverter pump mounted
T2	High-pressure inverter pump mounted

* Be sure to select 1 of the 2 options.

Option 1 (p. 32)

Nil	None
DM	Electric conductivity control Applicable to DI water piping
M	Applicable to DI water piping

Water-cooled Refrigeration

HRR 050 - W [] - 40 - [] T1 U []



Cooling capacity
050 5500/5900 W (50/60 Hz)

Cooling method
W Water-cooled refrigeration

Pipe thread type

Nil	Rc
F	G (With Rc-G conversion fitting set)
N	NPT (With Rc-NPT conversion fitting set)

Power supply
40 3-phase 380 to 415 VAC (50/60 Hz)
 3-phase 460 to 480 VAC (60 Hz)

Option 3 (p. 35)

Nil	None
Y	With feet/Without rack mounting brackets
Z	Without either a flow sensor, bypass valve, particle filter or water leakage sensor
Z1	Without a flow sensor

Option 2 (pp. 33, 33-1)

T1	Inverter pump mounted
T2	High-pressure inverter pump mounted

* Be sure to select 1 of the 2 options.

Option 1 (p. 32)

Nil	None
DM	Electric conductivity control Applicable to DI water piping
M	Applicable to DI water piping



Specifications: 380 to 415 VAC/460 to 480 VAC Air-cooled Refrigeration

		HRR050-A-40
Cooling method		Air-cooled refrigeration
Refrigerant		R410A (HFC)
Refrigerant charge	kg	0.74
Control method		PID control
Ambient temperature/Humidity/Altitude *1*14		5 to 40°C, 30 to 70%, less than 3000 m
Circulating fluid *2		Tap water, 15% ethylene glycol aqueous solution
Set temperature range *1		5 to 35
Cooling capacity (50/60 Hz) *3		4800/5800
Heating capacity (50/60 Hz) *4		1100/1200
Temperature stability *5		±0.1
Pump capacity (50/60 Hz) *6		0.35 (@ 16 L/min)/0.35 (16 L/min)
Option T2 pump capacity (50/60 Hz) *6		0.4 (@ 24 L/min)/0.4 (24 L/min)
Rated flow (50/60 Hz) *7		16/16
Option T2 rated flow (50/60 Hz) *7		24/24
Flow display range *19		5 to 40
Electric conductivity display range		0.1 to 48 (Only for Option DM)
Electric conductivity setting range		0.5 to 45 (Only for Option DM)
Particle filter nominal filtration rating *18		5
Bypass valve *18		Installed
Tank capacity		5
Outlet, Return port size		Rc1/2
Drain port size		Rc1/4, With cap
Fluid contact material		Stainless steel, Copper (Heat exchanger brazing)*12, SiC, Alumina ceramic, Carbon, PP, PE, POM, PA, FKM, EPDM, PVC, PPS, AS, Fluoropolymer*13, Ion exchange resin*13
Power supply		3-phase 380 to 415 VAC (50/60 Hz), Allowable voltage range ±10% (No continuous voltage fluctuation) 3-phase 460 to 480 VAC (60 Hz), Allowable voltage range +4%, -10% (Max. voltage less than 500 V and no continuous voltage fluctuation)
Circuit protector		A
Applicable earth leakage breaker capacity *8		10
Cable quantity x Size (Including grounding cable) *15		Rated current: 10 A Sensitivity current: 30 mA 4 cores x 14 AWG
Rated operating current (50/60 Hz) *16		4.4/4.1
Rated operating current (50/60 Hz) For Option T2		(4.9/4.5)
Rated power consumption (50/60 Hz) *16		2.2/2.5 (3.1/2.9)
Rated power consumption (50/60 Hz) For Option T2		2.4/2.7 (3.6/3.1)
Communication function		Contact input/output, Serial RS-485/RS-232C
Noise level (50/60 Hz) *9		70/70
Dimensions *10		W483 x D550 x H710
Accessories *17		Power supply connector, Particle filter element*18, Maintenance handle*18, Operation manual
Weight *11		kg 67

*1 No condensation should be present. During seasons or in locations where the ambient temperature is likely to fall below freezing point, please contact SMC.
 *2 If tap water is used, use water that is compliant with the Water Quality Standards of the Japan Refrigeration and Air Conditioning Industry Association (JRA GL-02-1994 cooling water system - circulating type - make-up water).
 *3 ① Ambient temperature: 25°C, ② Circulating fluid temperature: 20°C, ③ Circulating fluid at the rated flow, ④ Circulating fluid: Tap water, ⑤ Power supply: 400 VAC, ⑥ Piping length: Shortest
 For models with a high-pressure inverter pump mounted (Option T2), the cooling capacity will decrease by 400 W.
 *4 ① Ambient temperature: 25°C, ② Circulating fluid temperature: 20°C, ③ Circulating fluid at the rated flow, ④ Circulating fluid: Tap water, ⑤ Power supply: 400 VAC, ⑥ Piping length: Shortest
 *5 Temperature at the thermo-chiller outlet when the circulating fluid flow is at the rated flow and the circulating fluid outlet and return port are directly connected
 The installation environment and power supply are within the specification range and stable.
 *6 The capacity at the thermo-chiller outlet when the circulating fluid temperature is 20°C
 *7 The required flow rate for maintaining the cooling capacity or temperature stability
 The specification of the cooling capacity and the temperature stability may not be satisfied if the flow rate is lower than the rated flow.
 *8 Purchase an earth leakage breaker with a sensitivity current of 30 mA and a power supply of 400 VAC separately.

*9 Front: 1 m, height: 1 m, stable with no load, Other conditions → See *4.
 *10 Dimensions between panels, not including the dimensions of protrusion
 When Option Y (With feet/Without rack mounting brackets) is selected, refer to page 35.
 *11 Weight in the dry state without circulating fluids
 The weight will increase by 1 kg when Option DM (Electric conductivity control + Applicable to DI water piping) is selected.
 The weight will decrease by 2 kg for Option Z (Removed parts).
 *12 Options M (Applicable to DI water piping) and DM (Electric conductivity control + Applicable to DI water piping) do not contain copper.
 *13 For Option DM (Electric conductivity control + Applicable to DI water piping)
 *14 If the product is used at an altitude of 1000 m or higher, refer to "For altitudes of 1000 m or higher" on page 42.
 *15 To be prepared by the customer
 *16 ① Ambient temperature: 25°C, ② Circulating fluid temperature: 20°C, ③ Circulating fluid at the rated flow, ④ Circulating fluid: Tap water, ⑤ Power supply: 200 VAC, ⑥ Piping length: Shortest, ⑦ With the rated cooling load applied
 *17 For Option DM (Electric conductivity control + Applicable to DI water piping), a DI filter is included.
 For pipe thread type F, a G thread conversion fitting set is included.
 For pipe thread type N, an NPT thread conversion fitting set is included.
 *18 Not included for Option Z (Removed parts)
 *19 Not included for Options Z and Z1 (Removed parts)

Specifications: 380 to 415 VAC/460 to 480 VAC **Water-cooled Refrigeration**

		HRR050-W-40
Cooling method		Water-cooled refrigeration
Refrigerant		R410A (HFC)
Refrigerant charge	kg	0.62
Control method		PID control
Ambient temperature/Humidity/Altitude *1*15		5 to 40°C, 30 to 70%, less than 3000 m
Circulating fluid *2		Tap water, 15% ethylene glycol aqueous solution
Set temperature range *1	°C	5 to 35
Cooling capacity (50/60 Hz) *3	W	5500/5900
Heating capacity (50/60 Hz) *4	W	1100/1200
Temperature stability *5	°C	±0.1
Pump capacity (50/60 Hz) *6	MPa	0.35 (@ 16 L/min)/0.35 (16 L/min)
Option T2 pump capacity (50/60 Hz) *6		0.4 (@ 24 L/min)/0.4 (24 L/min)
Rated flow (50/60 Hz) *7	L/min	16/16
Option T2 rated flow (50/60 Hz) *7		24/24
Flow display range *20	L/min	5 to 40
Electric conductivity display range		0.1 to 48 (Only for Option DM)
Electric conductivity setting range		0.5 to 45 (Only for Option DM)
Particle filter nominal filtration rating *19	µm	5
Bypass valve *19		Installed
Tank capacity	L	5
Outlet, Return port size		Rc1/2
Drain port size		Rc1/4, With cap
Fluid contact material		Stainless steel, Copper (Heat exchanger brazing)*12, SiC, Alumina ceramic, Carbon, PP, PE, POM, PA, FKM, EPDM, PVC, PPS, AS, Fluoropolymer*13, Ion exchange resin*13
Temperature range	°C	5 to 35
Pressure range	MPa	0.3 to 0.5
Required flow rate *14	L/min	16
Inlet-outlet pressure differential of facility water		0.3 or more
Port size		Rc3/8
Fluid contact material		Stainless steel, Copper (Heat exchanger brazing), Bronze, Brass, Synthetic rubber
Power supply		3-phase 380 to 415 VAC (50/60 Hz), Allowable voltage range ±10% (No continuous voltage fluctuation) 3-phase 460 to 480 VAC (60 Hz), Allowable voltage range +4%, -10% (Max. voltage less than 500 V and no continuous voltage fluctuation)
Circuit protector	A	10
Applicable earth leakage breaker capacity *8		Rated current: 10 A Sensitivity current: 30 mA
Cable quantity x Size (Including grounding cable) *16		4 cores x 14 AWG
Rated operating current (50/60 Hz) *17	A	4.1/3.5
Rated operating current (50/60 Hz) For Option T2		4.4/3.8
Rated power consumption (50/60 Hz) *17	kW	1.9/2.1 (2.9/2.5)
Rated power consumption (50/60 Hz) For Option T2		2.1/2.3 (3.1/2.7)
Communication function		Contact input/output, Serial RS-485/RS-232C
Noise level (50/60 Hz) *9		70/70
Dimensions *10		W483 x D550 x H710
Accessories *18		Power supply connector, Particle filter element*19, Maintenance handle*19, Operation manual
Weight *11	kg	61

*1 No condensation should be present. During seasons or in locations where the ambient temperature is likely to fall below freezing point, please contact SMC.

*2 If tap water is used, use water that is compliant with the Water Quality Standards of the Japan Refrigeration and Air Conditioning Industry Association (JRA GL-02-1994 cooling water system - circulating type - make-up water).

*3 ① Facility water temperature: 25°C, ② Circulating fluid temperature: 20°C, ③ Circulating fluid at the rated flow, ④ Circulating fluid: Tap water, ⑤ Power supply: 400 VAC, ⑥ Piping length: Shortest
For models with a high-pressure inverter pump mounted (Option T2), the cooling capacity will decrease by 400 W.

*4 ① Facility water temperature: 25°C, ② Circulating fluid temperature: 20°C, ③ Circulating fluid at the rated flow, ④ Circulating fluid: Tap water, ⑤ Power supply: 400 VAC, ⑥ Piping length: Shortest

*5 Temperature at the thermo-chiller outlet when the circulating fluid flow is at the rated flow and the circulating fluid outlet and return port are directly connected. The installation environment and power supply are within the specification range and stable.

*6 The capacity at the thermo-chiller outlet when the circulating fluid temperature is 20°C

*7 The required flow rate for maintaining the cooling capacity or temperature stability
The specification of the cooling capacity and the temperature stability may not be satisfied if the flow rate is lower than the rated flow.

*8 Purchase an earth leakage breaker with a sensitivity current of 30 mA and a power supply of 400 VAC separately.

*9 Front: 1 m, height: 1 m, stable with no load, Other conditions → See *4.

*10 Dimensions between panels, not including the dimensions of protrusion. When Option Y (With feet/Without rack mounting brackets) is selected, refer to page 35.

*11 Weight in the dry state without circulating fluids
The weight will increase by 1 kg when Option DM (Electric conductivity control + Applicable to DI water piping) is selected.
The weight will decrease by 2 kg for Option Z (Removed parts).

*12 Options M (Applicable to DI water piping) and DM (Electric conductivity control + Applicable to DI water piping) do not contain copper.

*13 For Option DM (Electric conductivity control + Applicable to DI water piping)

*14 The required flow rate when the cooling capacity load is applied under the conditions in *3

*15 If the product is used at an altitude of 1000 m or higher, refer to "For altitudes of 1000 m or higher" on page 42.

*16 To be prepared by the customer

*17 ① Facility water temperature: 25°C, ② Circulating fluid temperature: 20°C, ③ Circulating fluid at the rated flow, ④ Circulating fluid: Tap water, ⑤ Power supply: 400 VAC, ⑥ Piping length: Shortest, ⑦ With the rated cooling load applied

*18 For Option DM (Electric conductivity control + Applicable to DI water piping), a DI filter is included.
For pipe thread type F, a G thread conversion fitting set is included.
For pipe thread type N, an NPT thread conversion fitting set is included.

*19 Not included for Option Z (Removed parts)

*20 Not included for Options Z and Z1 (Removed parts)

* If the product is used at an altitude of 1000 m or higher, refer to "Operating Environment/Storage Environment" (page 42) Item 14 "For altitudes of 1000 m or higher."
 * For models with an inverter pump mounted (-T1) and models with a high-pressure pump mounted (-T, -MT), the cooling capacity will decrease by about 300 W from each graph.

Cooling Capacity

HRR010-A-10-□

[50 Hz]

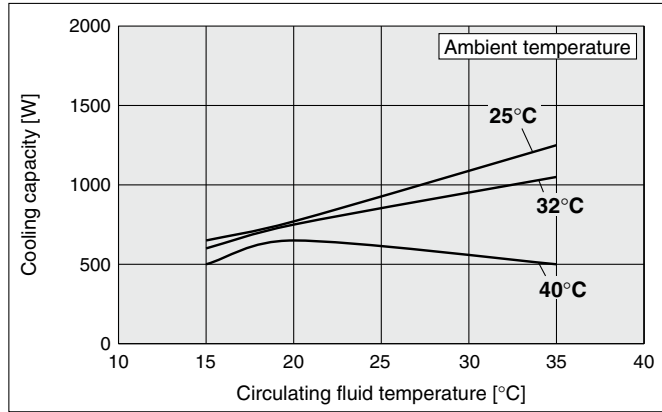

[60 Hz]

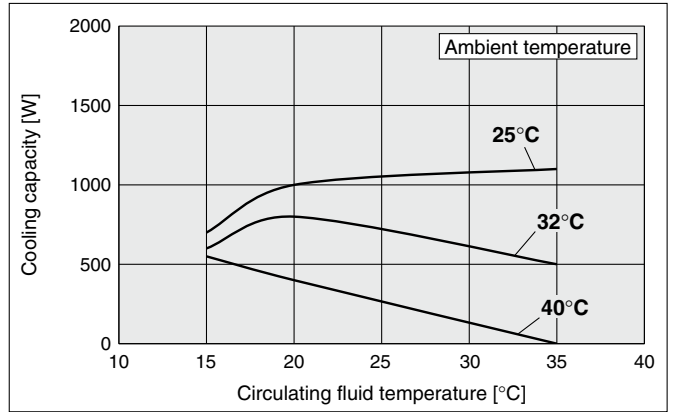

HRR010-W-10-□

[50 Hz]

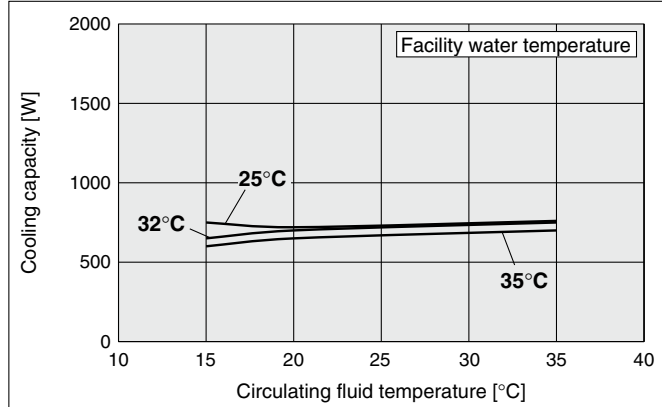

[60 Hz]

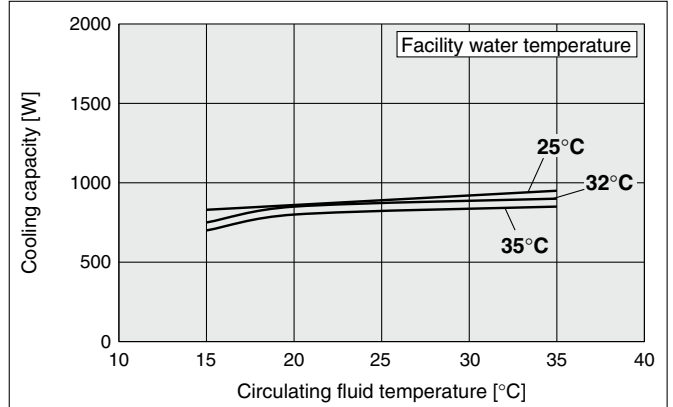

HRR010-A-20-□

[50 Hz]

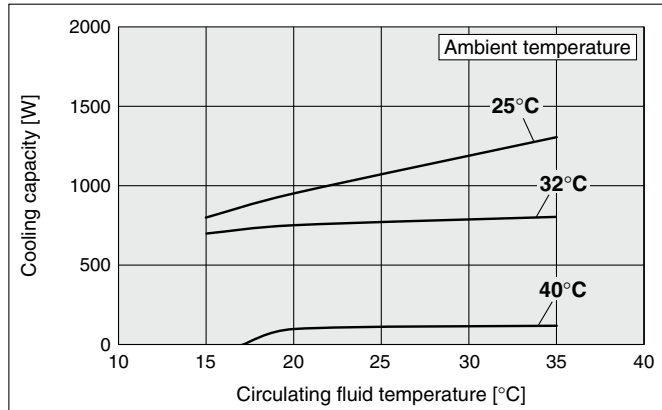

[60 Hz]

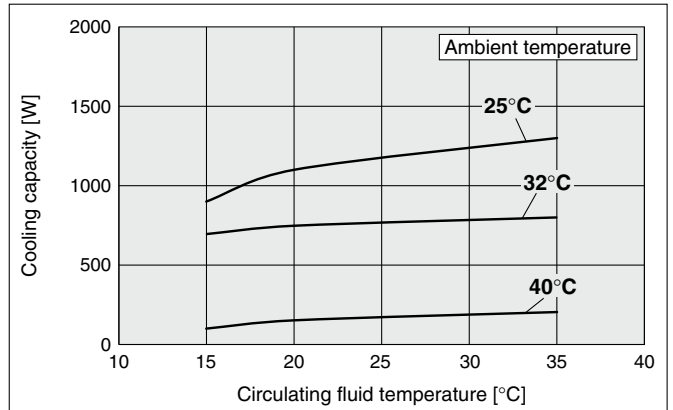

HRR010-W-20-□

[50 Hz]

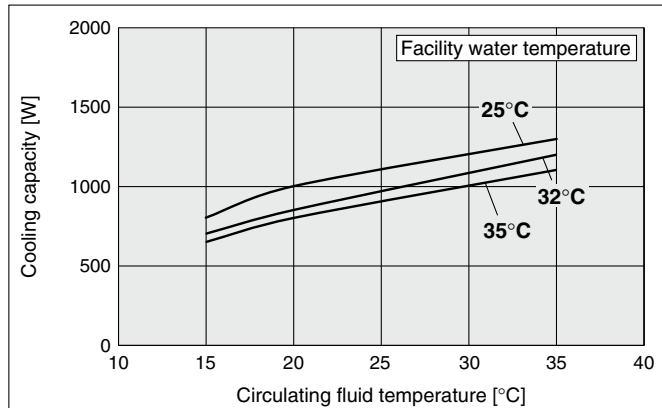

[60 Hz]

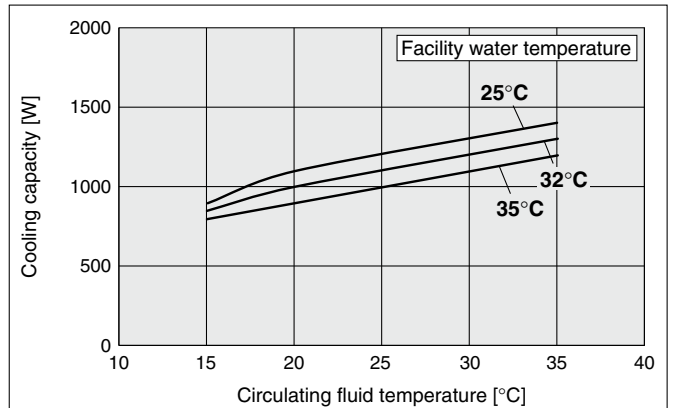

HRR Series

Cooling Capacity

* If the product is used at an altitude of 1000 m or higher, refer to "Operating Environment/Storage Environment" (page 42) Item 14 "For altitudes of 1000 m or higher."
 * For models with a high-pressure pump mounted (-T, -MT), the cooling capacity will decrease by about 300 W from each graph.

HRR012-A-10, HRR012-W-10 [50 Hz]

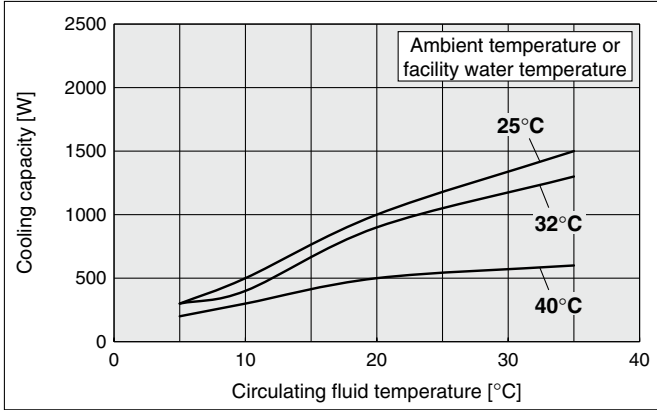

[60 Hz]

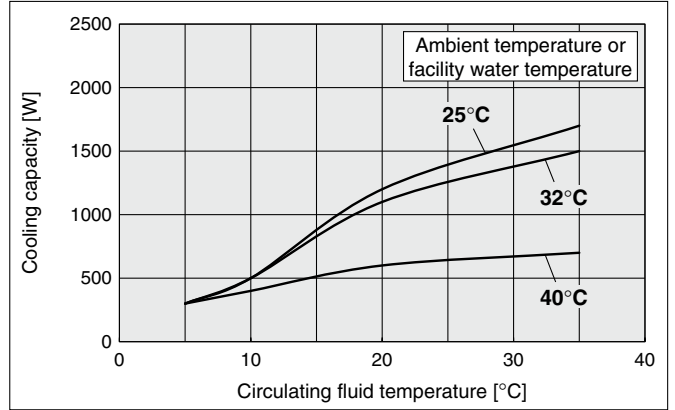

HRR018-A-10, HRR018-W-10 [50 Hz]

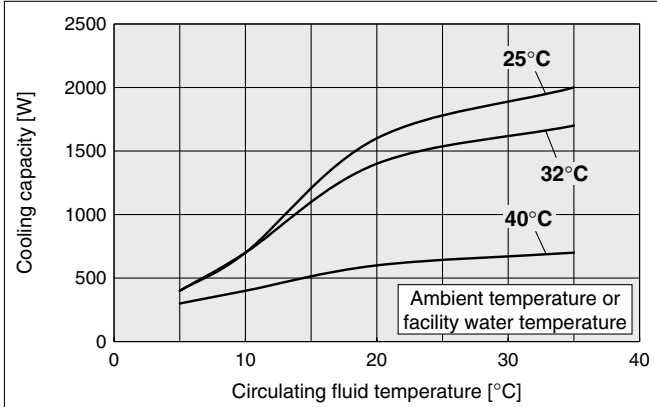

[60 Hz]

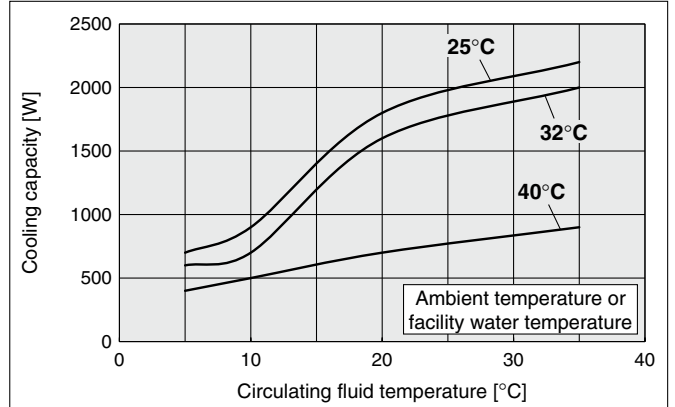

HRR024-A-20, HRR024-W-20 [50 Hz]

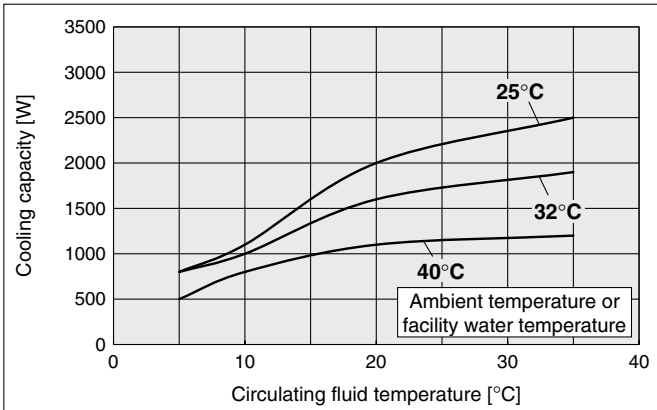

[60 Hz]

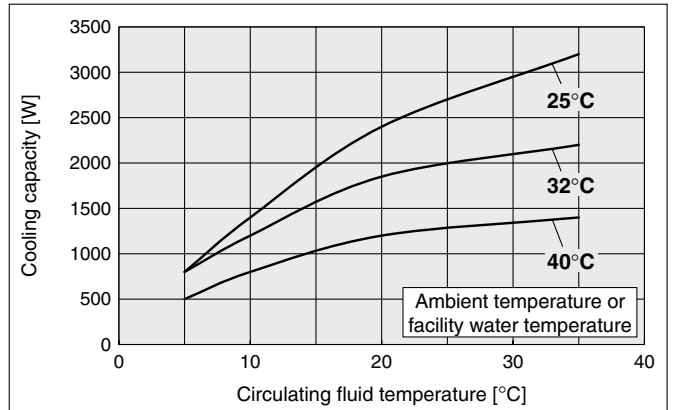

HRR030-A-20, HRR030-W-20 [50 Hz]

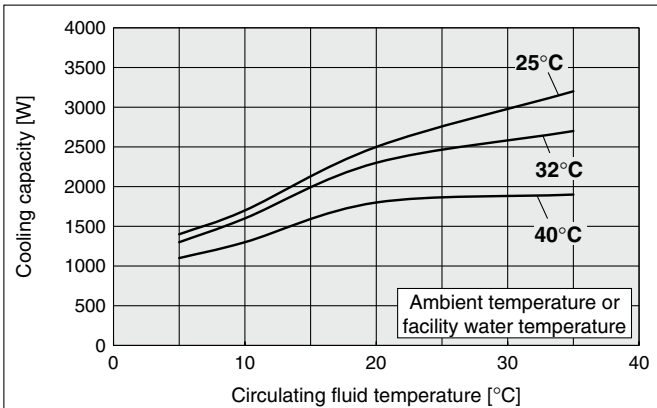

[60 Hz]

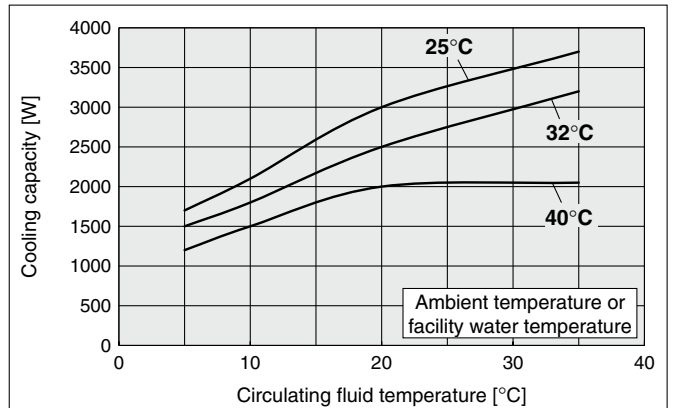

Cooling Capacity

* If the product is used at an altitude of 1000 m or higher, refer to "Operating Environment/Storage Environment" (page 42) Item 14 "For altitudes of 1000 m or higher."
 * For models with a high-pressure pump mounted (-T, -MT), the cooling capacity will decrease by about 300 W from each graph.

HRR050-A-20

[50 Hz]

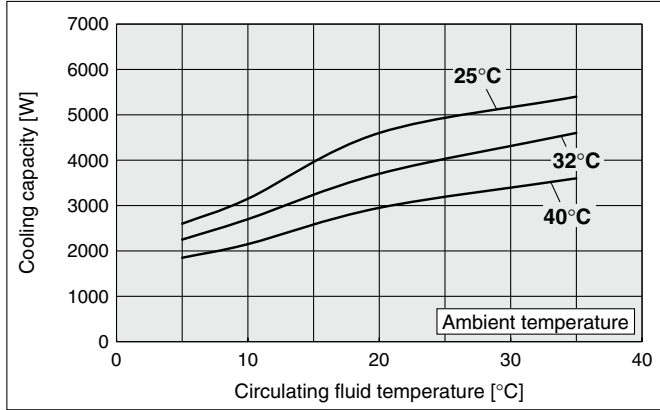

[60 Hz]

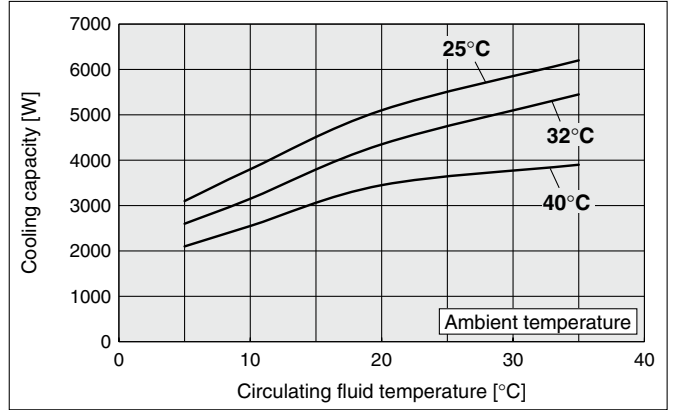

HRR050-W-20

[50 Hz]

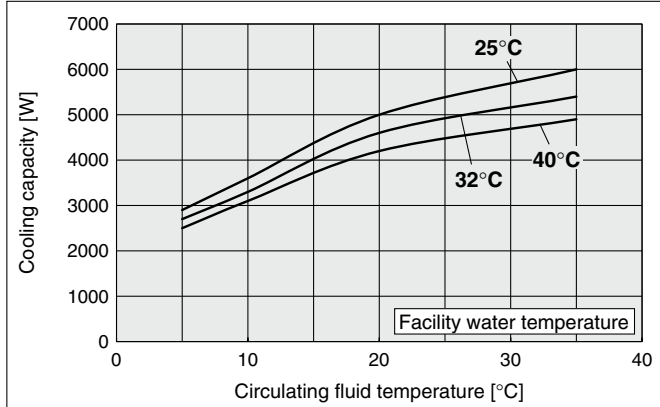

[60 Hz]

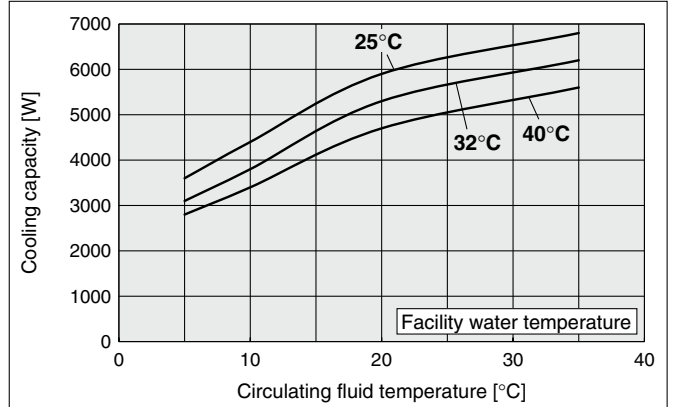

HRR050-A-40

[50 Hz]

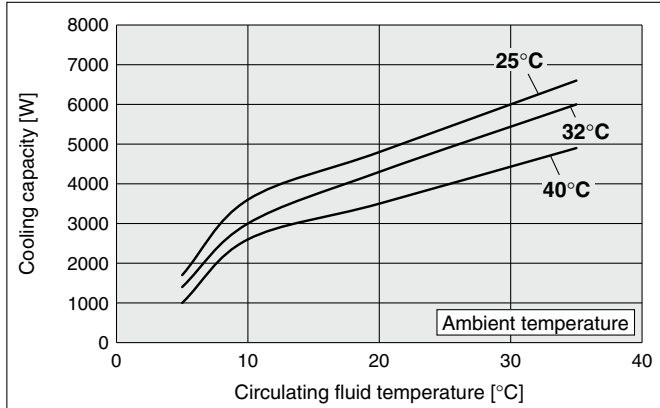

[60 Hz]

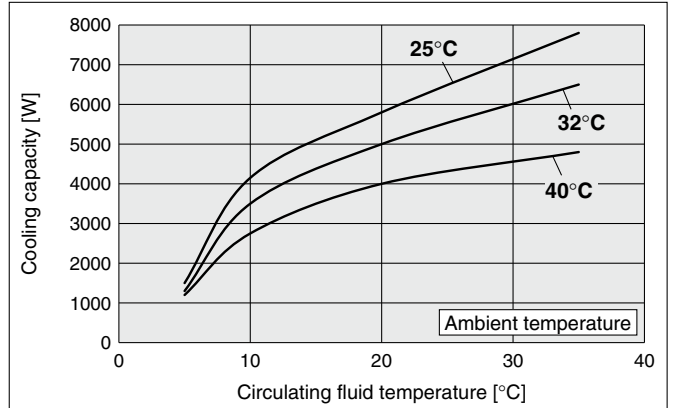

HRR050-W-40

[50 Hz]

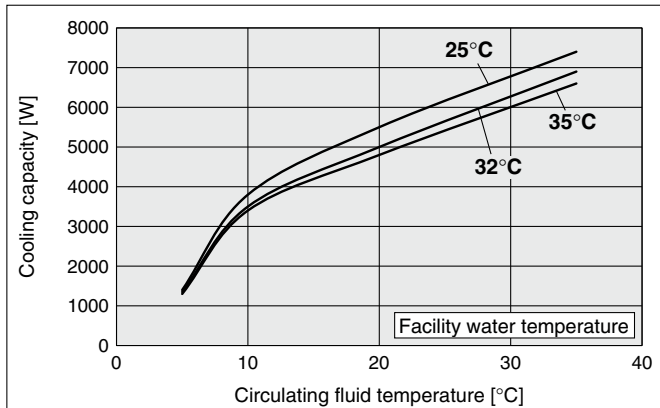

[60 Hz]

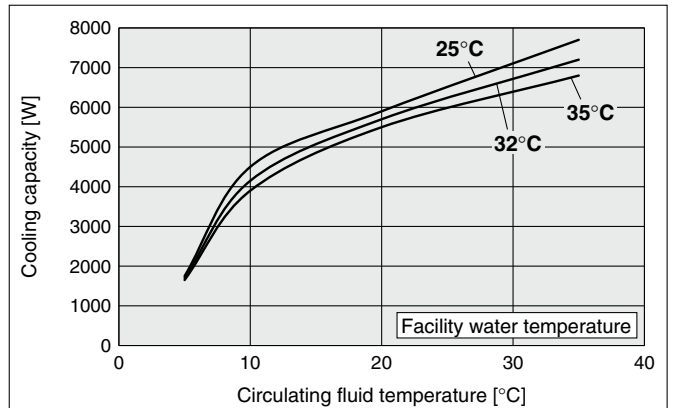

Heating Capacity

HRR010-A-10-□

[50 Hz]

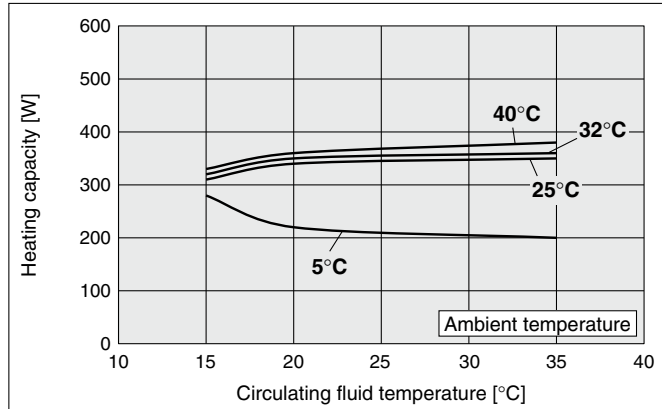

[60 Hz]

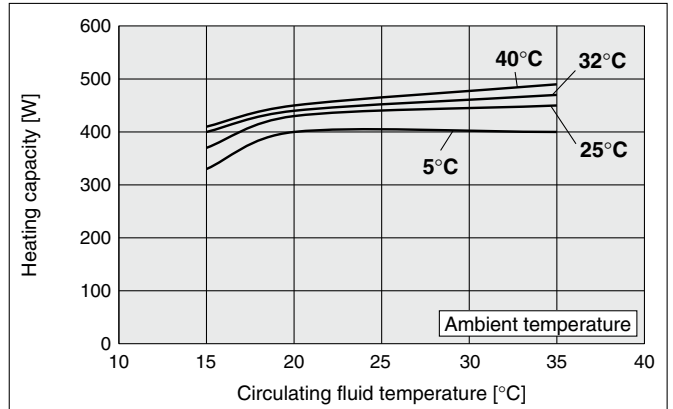

HRR010-W-10-□

[50 Hz]

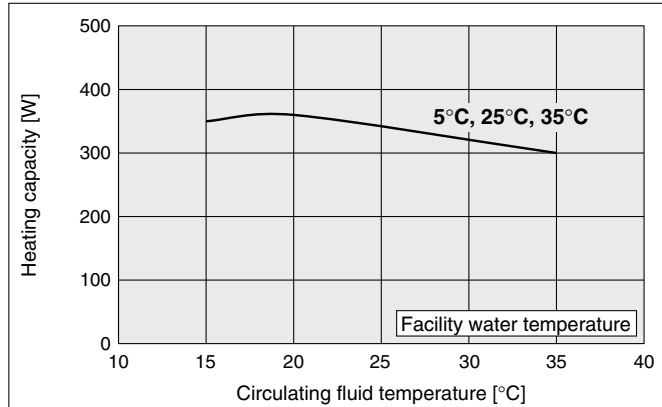

[60 Hz]

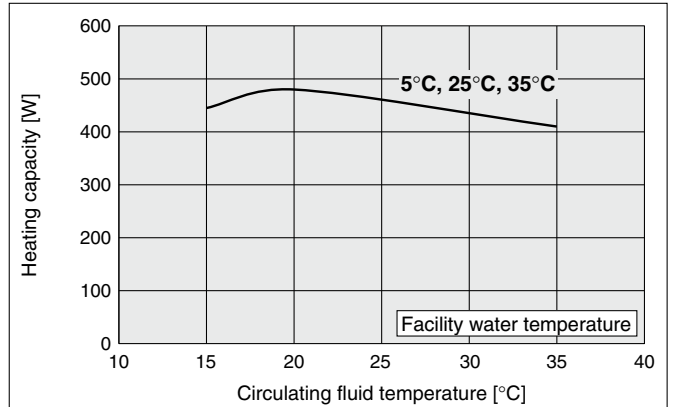

HRR010-A-20

[50 Hz]

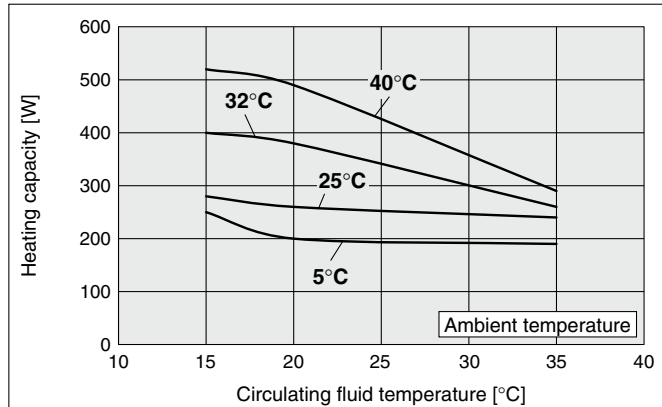

[60 Hz]

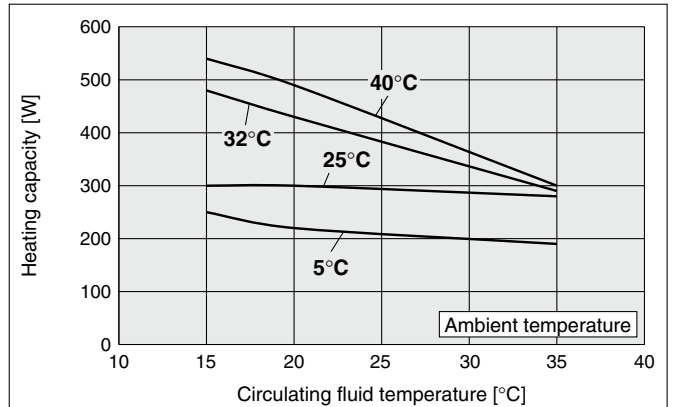

HRR010-W-20

[50 Hz]

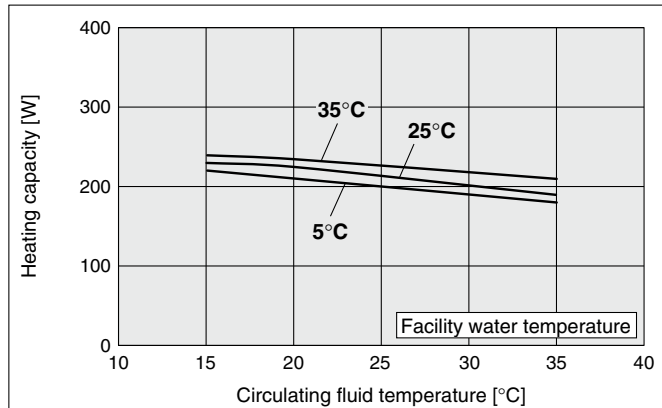

[60 Hz]

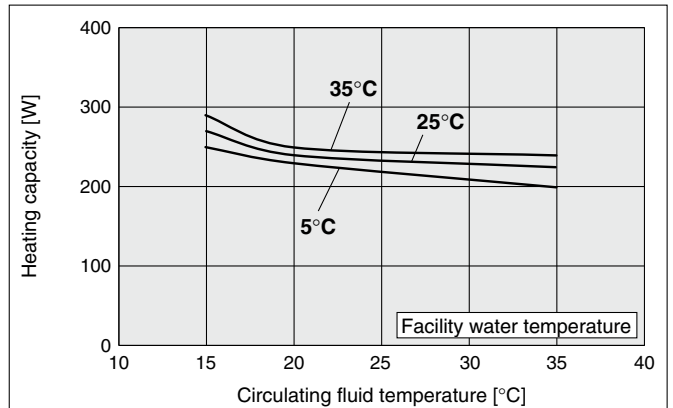

HRR Series

Heating Capacity

HRR₀₁₈⁰¹²-A-10, HRR₀₁₈⁰¹²-W-10

[50 Hz]

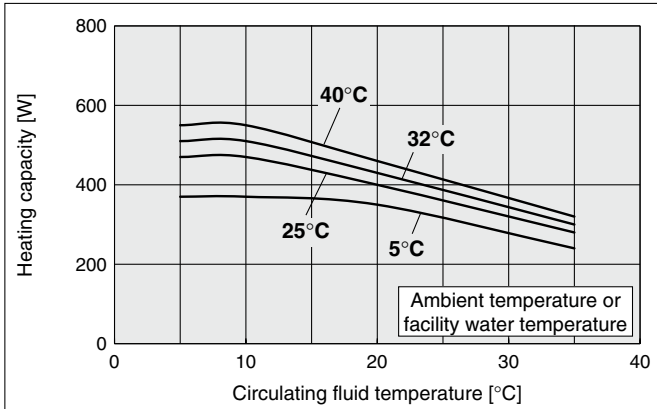

[60 Hz]

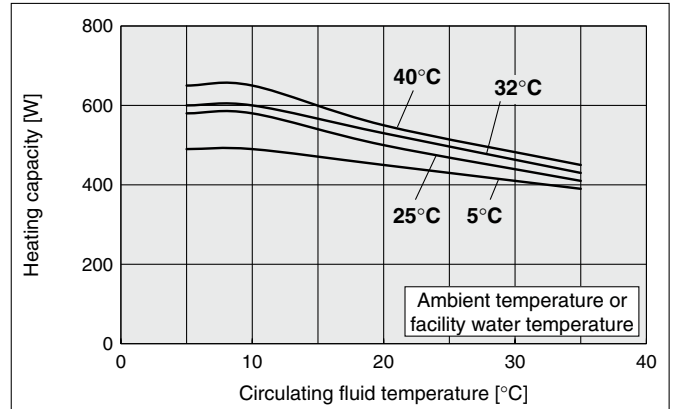

HRR₀₁₈⁰¹²-A-20, HRR₀₁₈⁰¹²-W-20

[50 Hz]

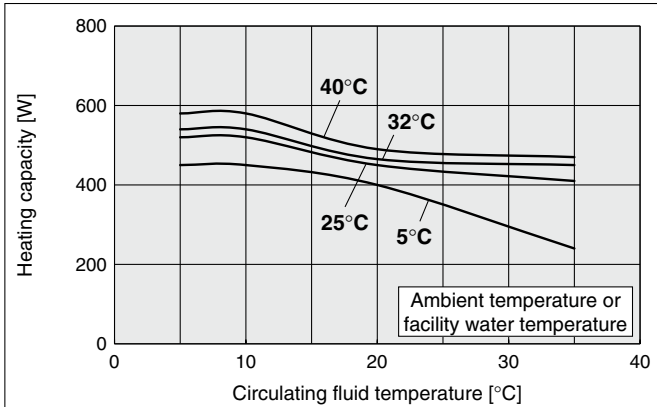

[60 Hz]

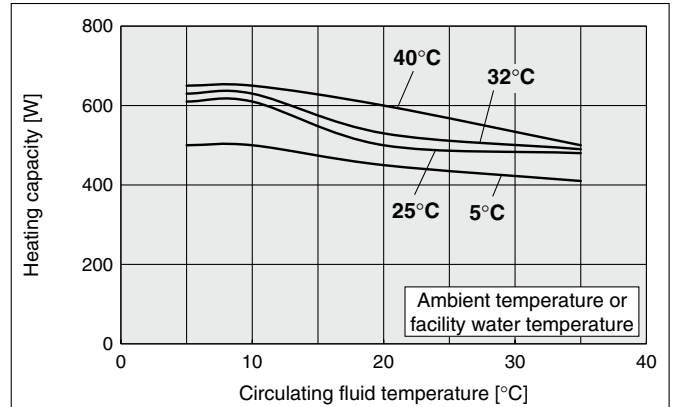

HRR₀₃₀⁰²⁴-A-20, HRR₀₃₀⁰²⁴-W-20

[50 Hz]

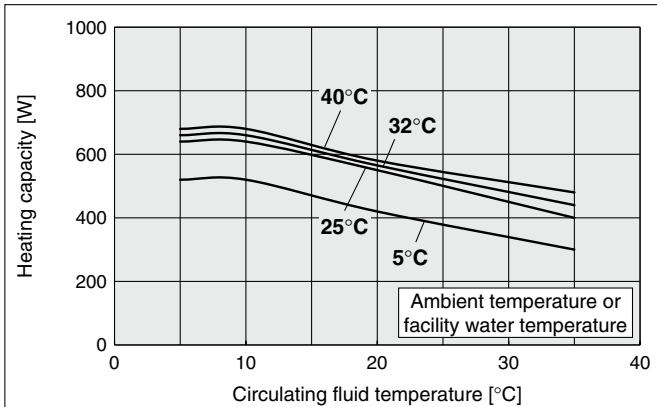

[60 Hz]

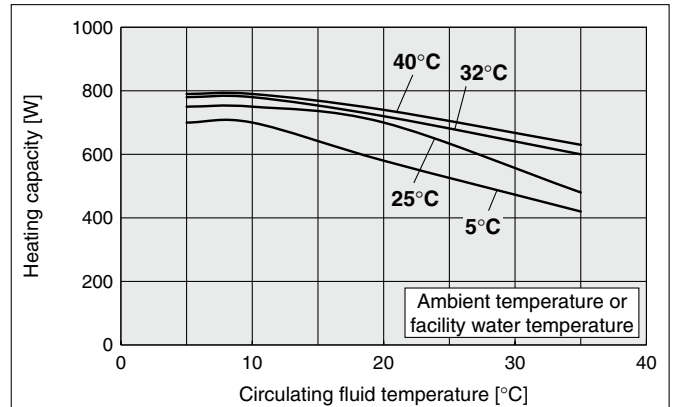

HRR050-A-20, HRR050-W-20

[50 Hz]

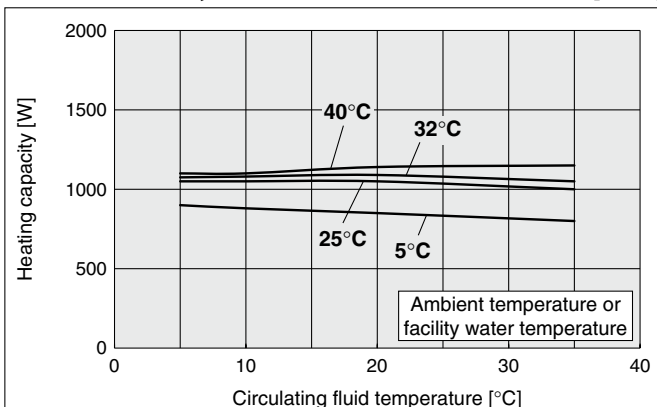

[60 Hz]

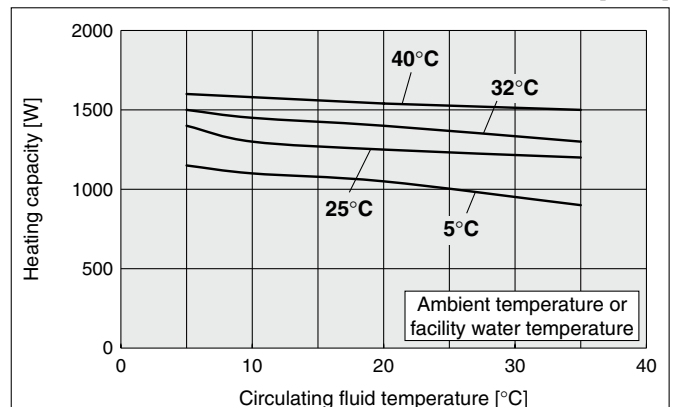

HRR Series

Heating Capacity

HRR050-A-40, HRR050-W-40

[50 Hz]

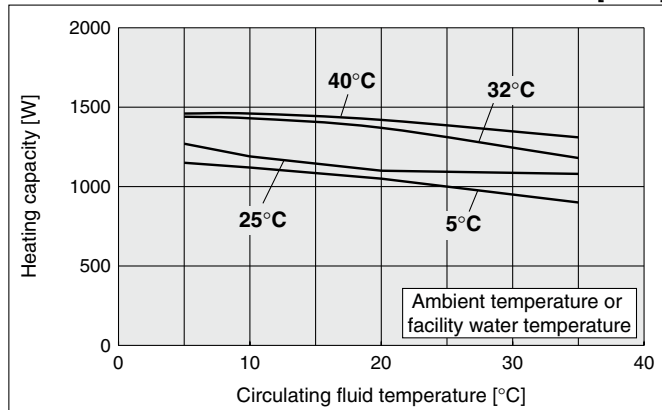

[60 Hz]

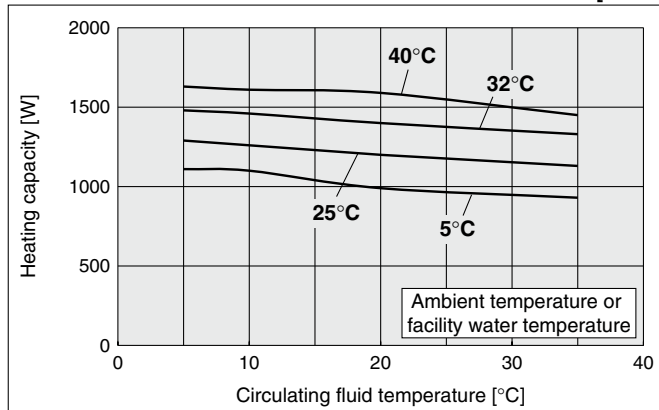

Pump Capacity

HRR010-A, HRR010-W

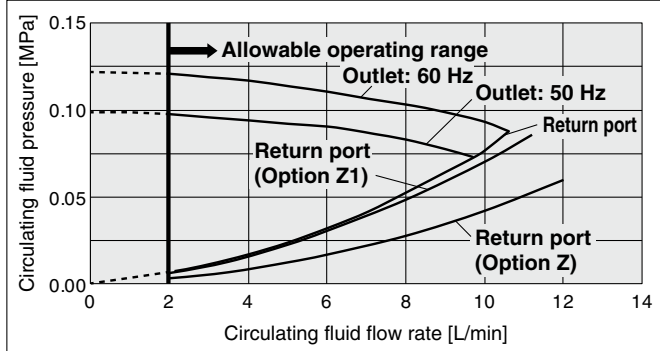

HRR⁰¹²₀₁₈⁰²⁴-A, HRR⁰¹²₀₁₈⁰²⁴-W
030

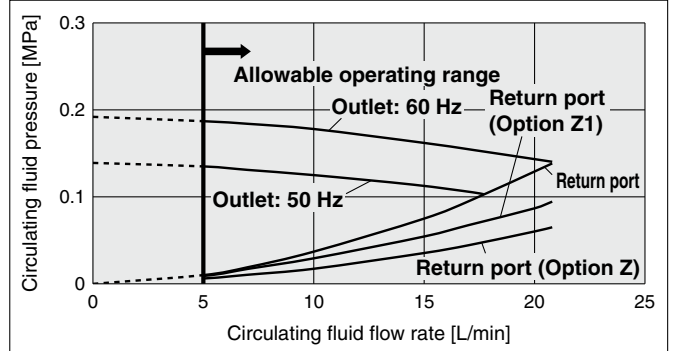

HRR050-A-20, HRR050-W-20

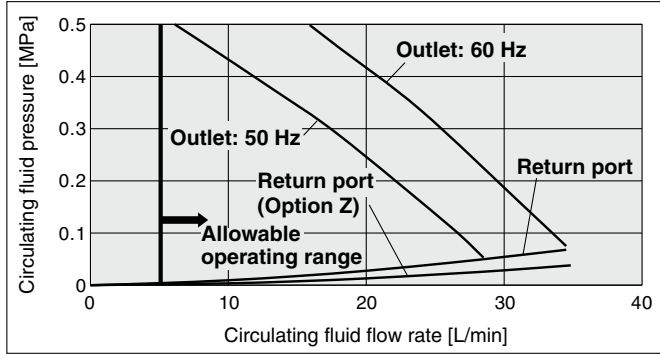

* Refer to the pump capacity graphs on pages 33 and 33-1 for the HRR050-A-40 and the HRR050-W-40.

Required Facility Water Flow Rate

HRR010-W

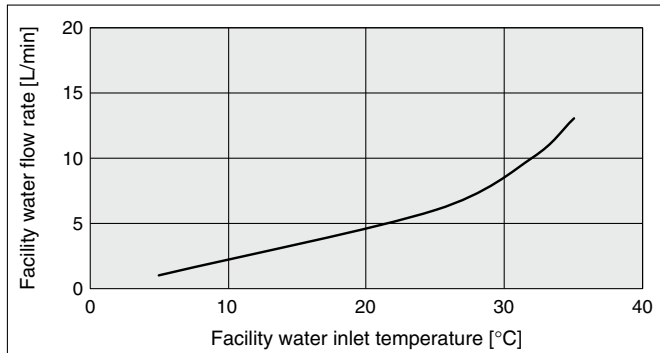

* This is the required facility water flow rate at the circulating fluid rated flow and the cooling capacity listed in the "Cooling Capacity" specifications.

HRR⁰¹²₀₁₈⁰²⁴-W
030

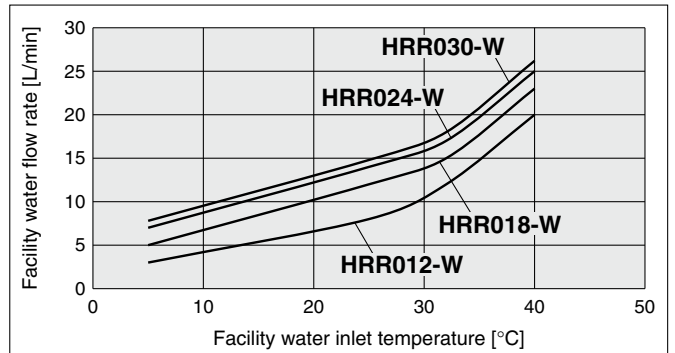

* This is the required facility water flow rate at the circulating fluid rated flow and the cooling capacity listed in the "Cooling Capacity" specifications.

HRR050-W-20

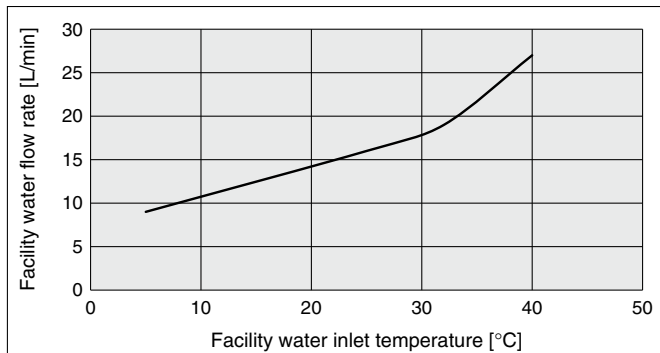

* This is the required facility water flow rate at the circulating fluid rated flow and the cooling capacity listed in the "Cooling Capacity" specifications.

HRR050-W-40

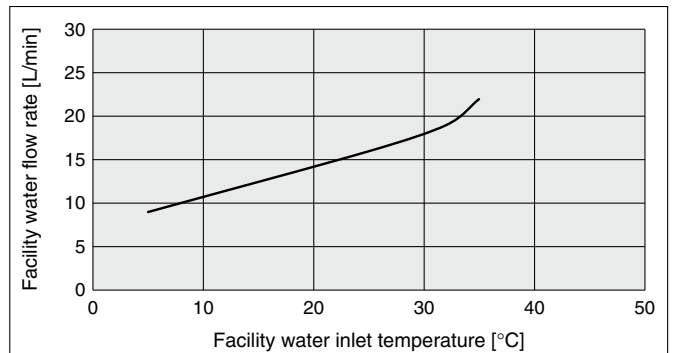

* This is the required facility water flow rate at the circulating fluid rated flow and the cooling capacity listed in the "Cooling Capacity" specifications.

HRR Series

Dimensions

Air-cooled Refrigeration

HRR010-A

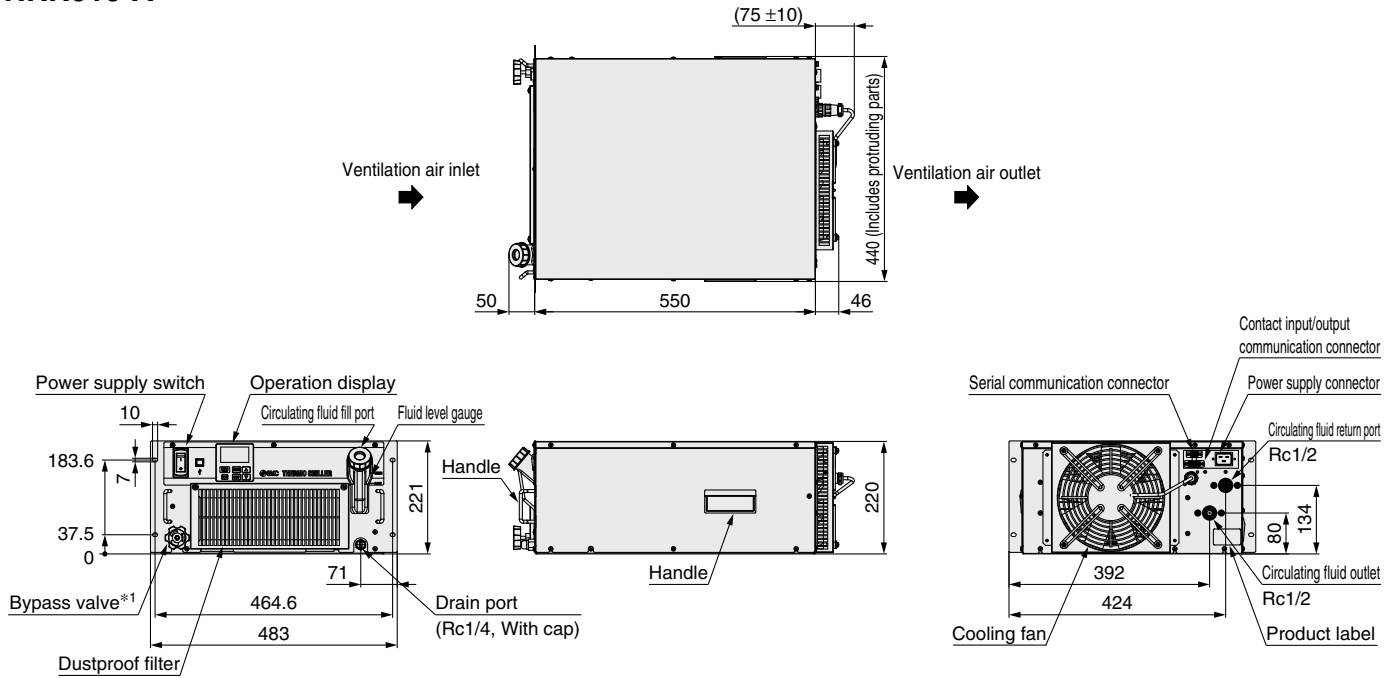

*1 Without bypass valve for Option Z (Removed parts)

* For Option Y (With feet/Without rack mounting brackets), refer to page 35.

Water-cooled Refrigeration

HRR010-W

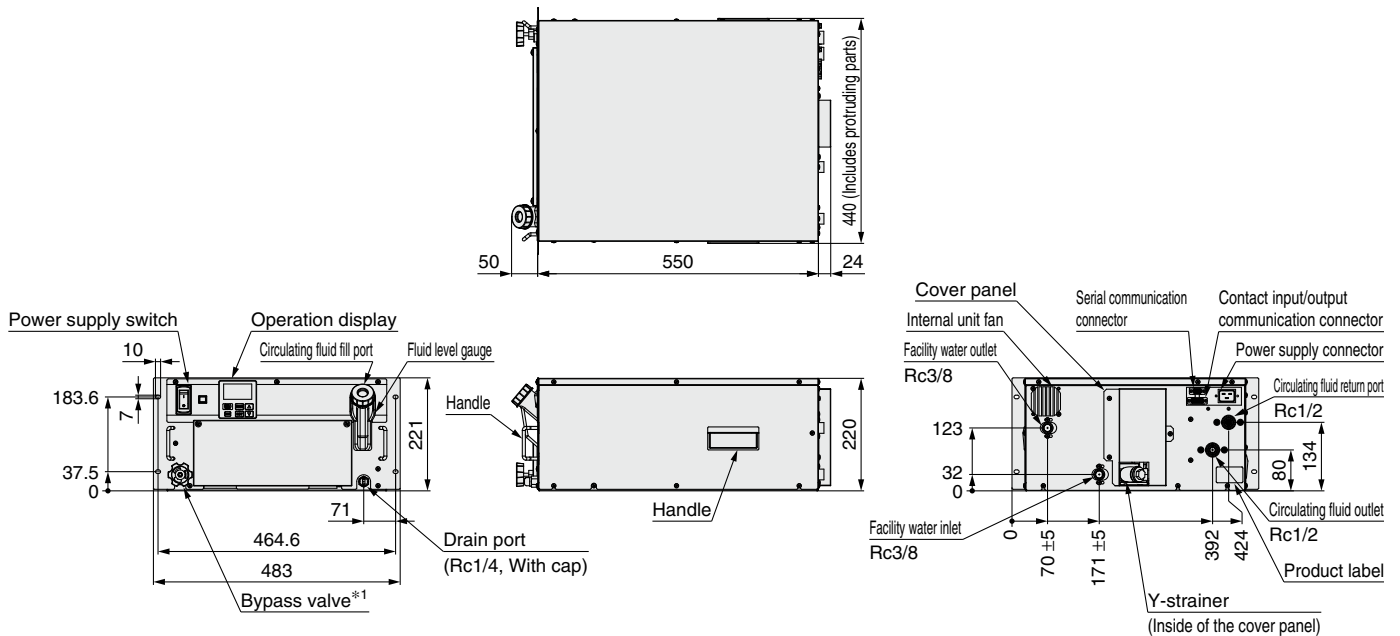

*1 Without bypass valve for Option Z (Removed parts)

* For Option Y (With feet/Without rack mounting brackets), refer to page 35.

Dimensions

Air-cooled Refrigeration

HRR012-A, HRR018-A

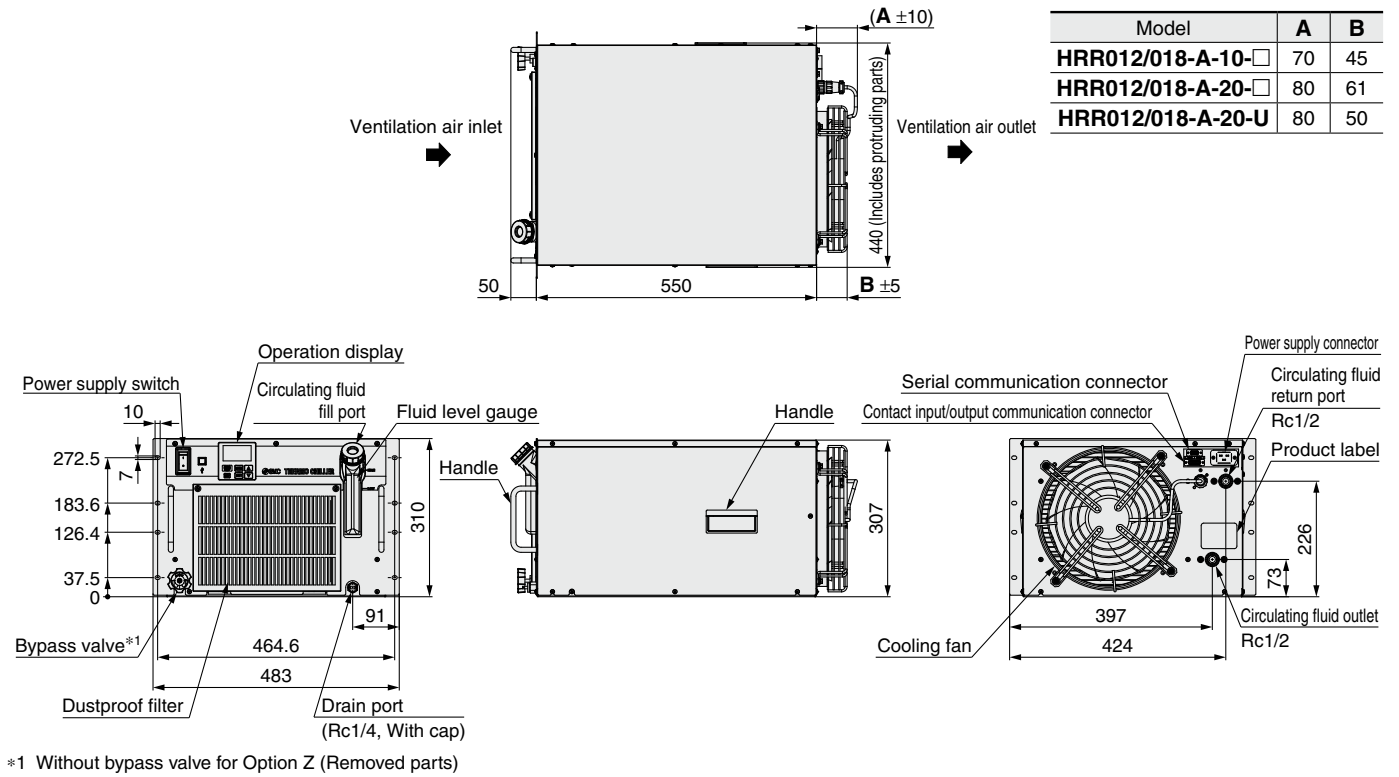

HRR024-A, HRR030-A

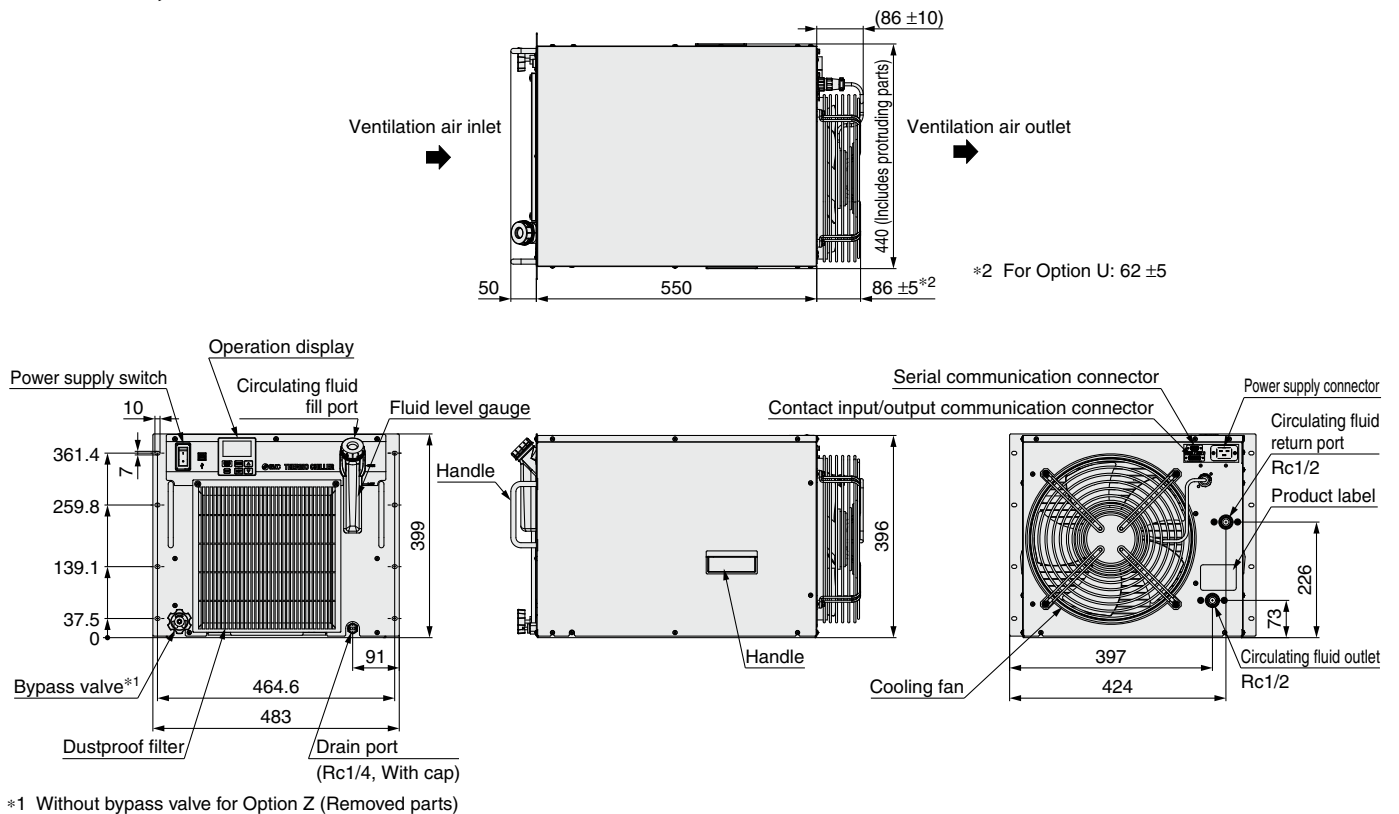

HRR Series

Dimensions

Water-cooled Refrigeration

HRR012-W, HRR018-W

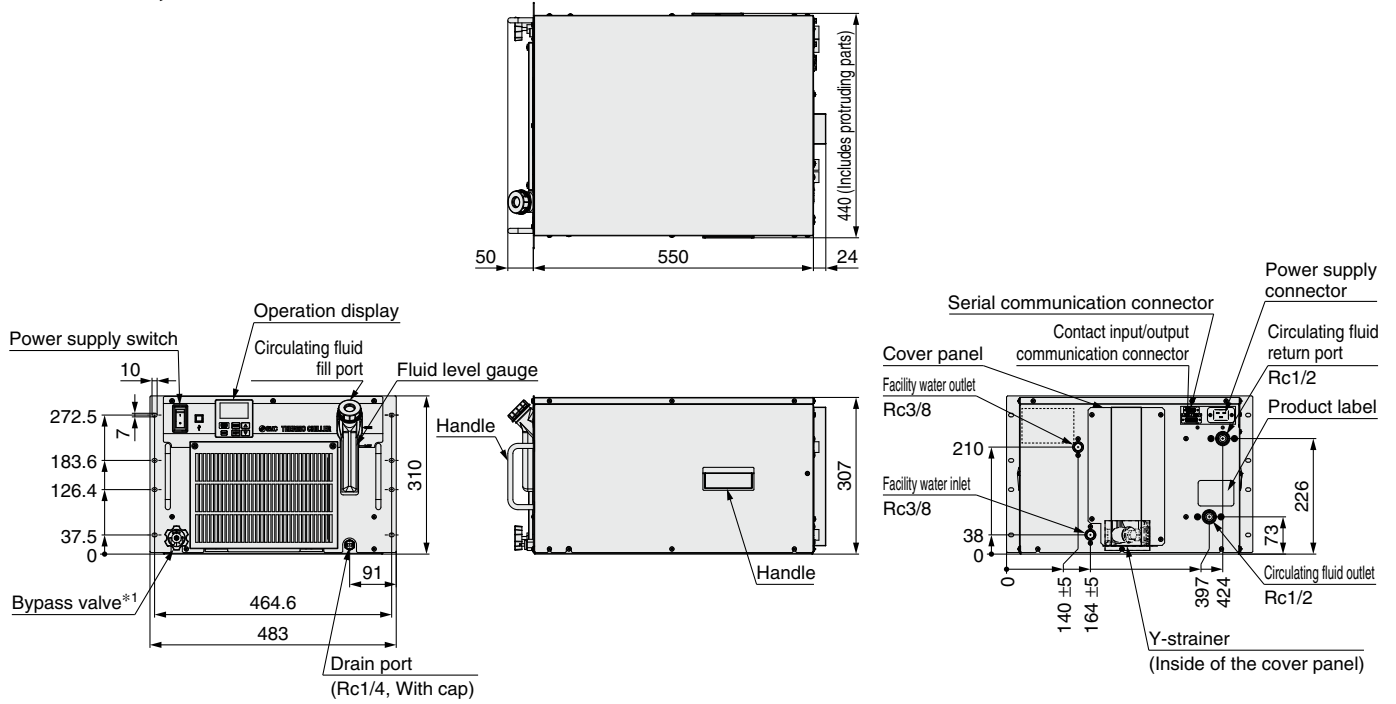

*1 Without bypass valve for Option Z (Removed parts)

* For Option "T1," there is an internal fan where the rectangle with dotted lines is.

HRR024-W, HRR030-W

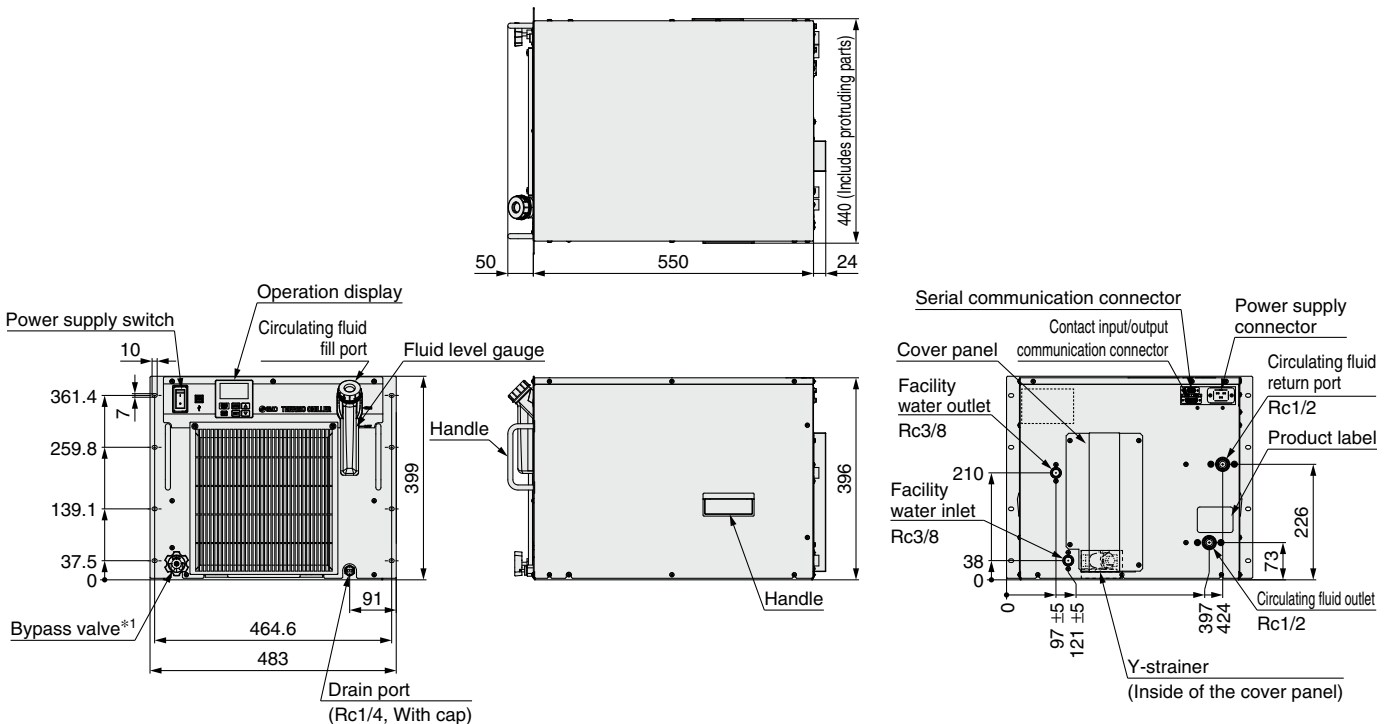

*1 Without bypass valve for Option Z (Removed parts)

* For Option "T1," there is an internal fan where the rectangle with dotted lines is.

Dimensions

Air-cooled Refrigeration

HRR050-A-20

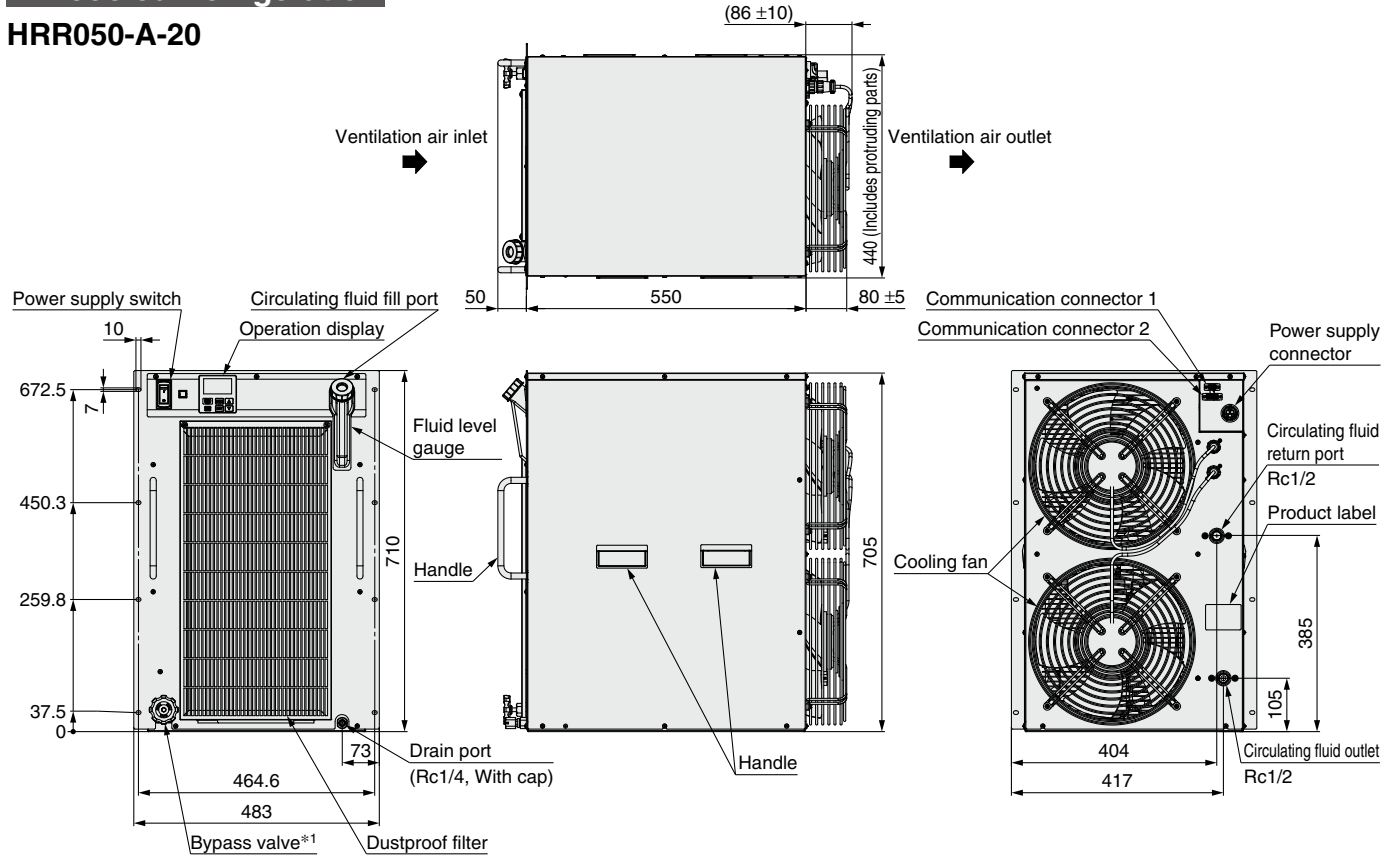

- *1 Without bypass valve for Option Z (Removed parts)
- * For Option Y (With feet/Without rack mounting brackets), refer to page 35.

Water-cooled Refrigeration

HRR050-W-20

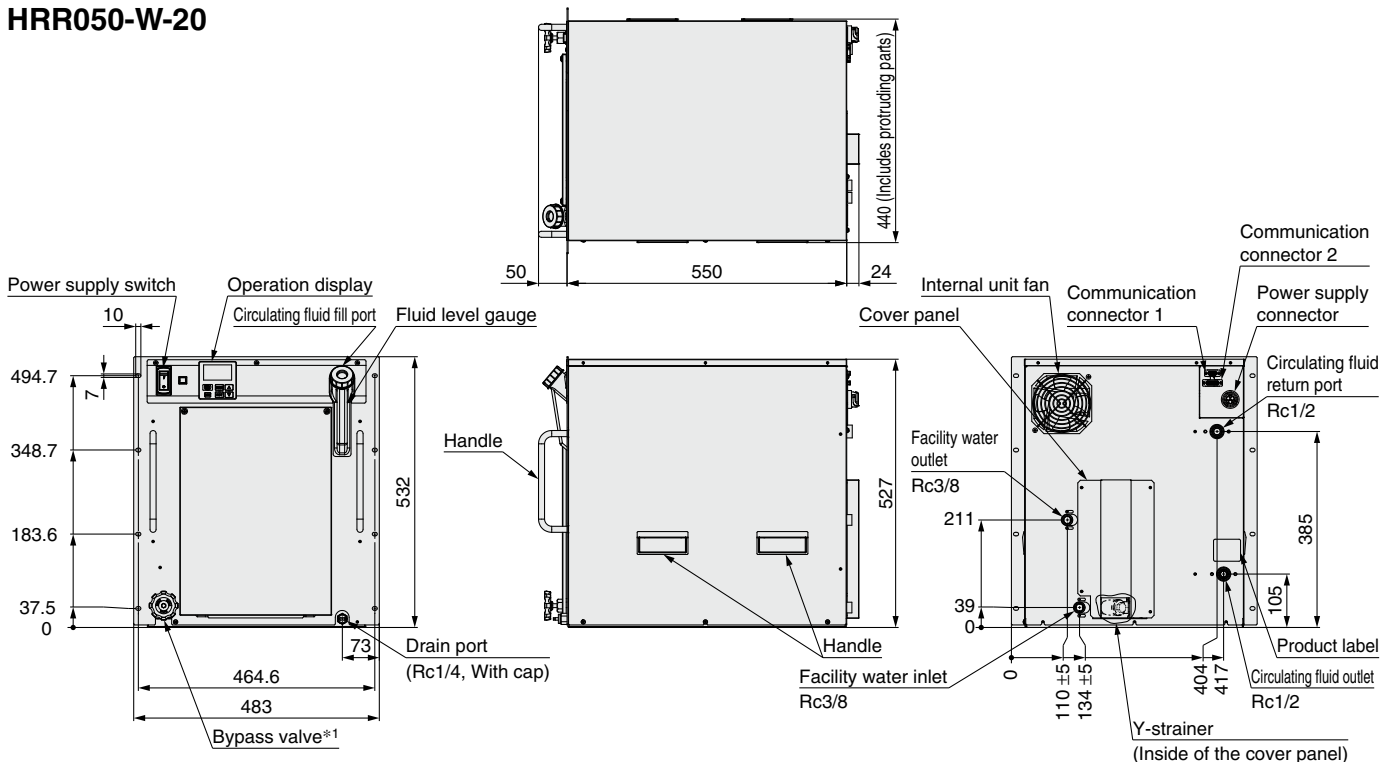

- *1 Without bypass valve for Option Z (Removed parts)
- * For Option Y (With feet/Without rack mounting brackets), refer to page 35.

Operation Display Panel

The basic operation of this unit is controlled through the operation panel on the front of the product.

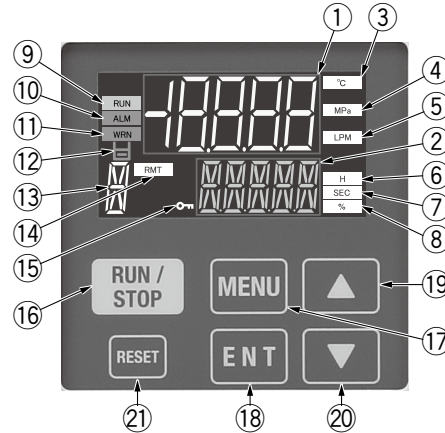

No.	Description	Function
①	Digital display (7-segment, 5 digits)	Displays the current circulating fluid discharge temperature, pressure, flow rate, alarm codes, and other set values
②	Digital display (11-segment, 5 digits)	Displays the circulating fluid discharge temperature and the set values of other menu items
③	[°C] lamp	Lights up when temperature is displayed on the digital display
④	[MPa] lamp	Lights up when pressure is displayed on the digital display
⑤	[LPM] lamp	Lights up when flow rate is displayed on the digital display
⑥	[H] lamp	Lights up when time is displayed on the digital display
⑦	[SEC] lamp	Lights up when seconds are displayed on the digital display
⑧	[%] lamp	Lights up when the pump output set value is displayed on the digital display
⑨	[RUN] lamp	Lights up during operation, and goes off when it is stopped
⑩	[ALM] lamp	Lights up when the FLT alarm occurs (This product will stop.)
⑪	[WRN] lamp	Lights up when the WRN alarm occurs (This product will continue operation.)
⑫	[] lamp	Lights up when "AL.01 Low level in tank abnormal" or "AL.02 Low level in tank" alarm is generated
⑬	Digital display (11-segment, 1 digit)	"X" is displayed when maintenance notification is generated.
⑭	[RMT] lamp	Lights up during remote operation by communication function
⑮	[KEYLOCK] lamp	Lights up when key lock setting is active
⑯	[RUN/STOP] key	Press and hold for 1 second to start or stop.
⑰	[MENU] key	Switching of each menu and cancellation of setting values
⑱	[ENT] key	Switch to setting mode and set values.
⑲	[▲] key	Move item upward or increase the set value.
⑳	[▼] key	Move item downward or decrease the set value.
㉑	[RESET] key	Reset the alarm.

Alarm

Various alarms are displayed with the ALM indicator and the alarm code in the white upper section of the operation display. These alarms can also be output through communication protocols.

Alarm code	Alarm message	Initial value	Display unit	
			Upper section (White)	Lower section (Green)
AL01	Low level in tank abnormal	FLT	AL01	LOW ⇒ LEVEL ⇒ FLT
AL02	Low level in tank	WRN	AL02	LOW ⇒ LEVEL ⇒ WRN
AL03	Phase loss/phase reverse error*10	FLT	AL03	PHASE ⇒ ERROR
AL04	Water leakage*6	WRN*1	AL04	WATER ⇒ LEAK
AL05	Pump inverter error*8	WRN	AL05	PUMP ⇒ INV
AL06	Internal fan stop*9	WRN	AL06	FAN ⇒ ERROR
AL07	Fan inverter error signal*10	WRN	AL07	FAN ⇒ INV
AL09	Circulating fluid discharge pressure rise	FLT*2	AL09	HIGH ⇒ PRESS
AL10	Flow rate reduction*7	WRN*1	AL10	LOW ⇒ FLOW ⇒ WRN
AL11	Outside ambient temperature range*3	OFF*1	AL11	AMB ⇒ TEMP ⇒ OUT
AL12	Electric conductivity rise*4	WRN*5	AL12	DI ⇒ ERROR
AL13	NOT TEMP READY	OFF*1	AL13	TEMP ⇒ READY ⇒ ERROR
AL14	Circulating fluid temperature range rise	OFF*1	AL14	TEMP ⇒ OUT.HI
AL15	Circulating fluid temperature range drop	OFF*1	AL15	TEMP ⇒ OUT.LO
AL17	Flow rate failure*7	FLT*1	AL17	LOW ⇒ FLOW ⇒ FLT
AL18	High circulating fluid discharge temp.	FLT	AL18	TEMP ⇒ FLT

- *1 Selectable from OFF/WRN/FLT
- OFF: Disables the alarm function
- WRN: Operation of this product will continue when the alarm occurs.
- FLT: Operation of this product will stop when the alarm occurs.
- *2 Selectable from WRN/FLT
- *3 Only air-cooled refrigeration type can be set.

Alarm code	Alarm message	Initial value	Display unit	
			Upper section (White)	Lower section (Green)
AL19	High circulating fluid return temp.	FLT	AL19	RET ⇒ TEMP ⇒ FLT
AL21	High circulating fluid discharge pressure	FLT	AL21	HIGH ⇒ PRESS ⇒ FLT
AL22	Low circulating fluid discharge pressure	FLT	AL22	LOW ⇒ PRESS ⇒ FLT
AL24	Memory abnormal	FLT	AL24	MEM ⇒ ERROR
AL25	Contact input 1 signal detection	FLT*1	AL25	INP1 ⇒ ERROR
AL26	Contact input 2 signal detection	FLT*1	AL26	INP2 ⇒ ERROR
AL27	Forced stop	FLT	AL27	FORCE ⇒ STOP
AL28	Maintenance notice	OFF*1	AL28	MANT ⇒ ALARM
AL29	Communication error	WRN*1	AL29	COMM ⇒ ERROR
AL30	Refrigerant circuit abnormal	FLT	AL30	REF ⇒ ERROR ⇒ 0000
AL31	Sensor abnormal	FLT	AL31	SENS ⇒ ERROR ⇒ 0000
AL32	Controller abnormal	FLT	AL32	CTRL ⇒ ERROR ⇒ 0000

- *4 Option DM (With electric conductivity control function, Applicable to DI water piping) only. When entering the range, the alarm is released automatically.
- *5 Selectable from OFF/WRN
- *6 Not generated for Option Z
- *7 Not generated for Options Z and Z1 (Excludes the HRR012 to 030 with Option "T1" and the HRR050-□-40)
- *8 For option T1.
- *9 Only water-cooled type
- *10 Only the HRR050-□-40

For details, refer to the "Operation Manual" on the SMC website.

Communication Functions

Contact Input/Output Communication Specifications

Item		Specifications	
Contact input signal 1, 2	Insulation method	Photocoupler	
	Rated input voltage	24 VDC	
	Operating voltage range	21.6 to 26.4 VDC	
	Rated input current	5 mA TYP	
	Input impedance	4.7 kΩ	
Contact output signal 1, 2, 3	Rated load voltage	48 VAC or less/30 VDC or less	
	Maximum load current	500 mA AC/DC (Resistance load)	
	Minimum load current	5 VDC 10 mA	
24 VDC Output voltage		24 VDC ±10% 500 mA MAX*1 (No inductive load)	

*1 When using the power supply of this product, make sure that the total load current is 500 mA or less.

Contact Input/Output Pin Nos.

Pin no.	Application	Division	Initial value (Default setting)
1	24 VDC output	Output	—
2	24 VDC output	Output	—
3	24 VDC output	Output	—
4	Contact input signal 1	Input	OFF
5	Common of contact output signal 1	Output	—
6	Common of contact output signal 2	Output	—
7	Common of contact output signal 3	Output	—
8	Unusable	—	—
9	24 COM output	Output	—
10	24 COM output	Output	—
11	Common of contact input signal	Output	—
12	Contact input signal 2	Input	OFF
13	Contact output signal 1	Output	Run status signal (N.O. type)
14	Contact output signal 2	Output	Remote status signal (N.O. type)
15	Contact output signal 3	Output	Alarm signal (N.C. type)

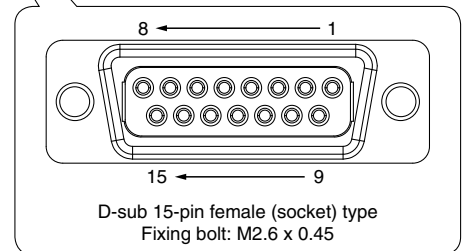
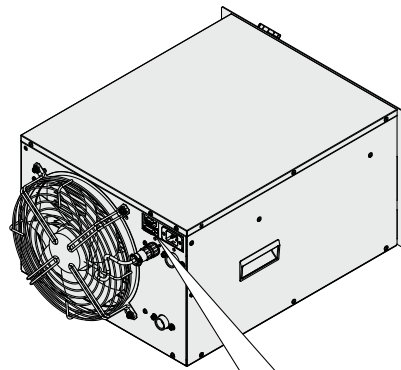

Contact input/output signal connector

Communication Functions

Serial Communication

The serial communication (RS-485/RS-232C) enables the following items to be written and read out.

Writing	Readout
Run/Stop Circulating fluid temperature setting	Circulating fluid discharge temperature Status information Circulating fluid flow rate Alarm occurrence information Circulating fluid discharge pressure Electric conductivity*1

*1 When using the Option DM

Item	Specifications
Connector type	D-sub 9-pin female connector
Standard	EIA standards, RS-485 (ASCII mode/RTU mode)
Circuit diagram	<p style="text-align: center;">* Be sure to wire to the correct pin numbers according to the diagram.</p>
Standard	EIA standards, RS-232C (ASCII mode/RTU mode)
Circuit diagram	<p style="text-align: center;">* Be sure to wire to the correct pin numbers according to the diagram.</p>

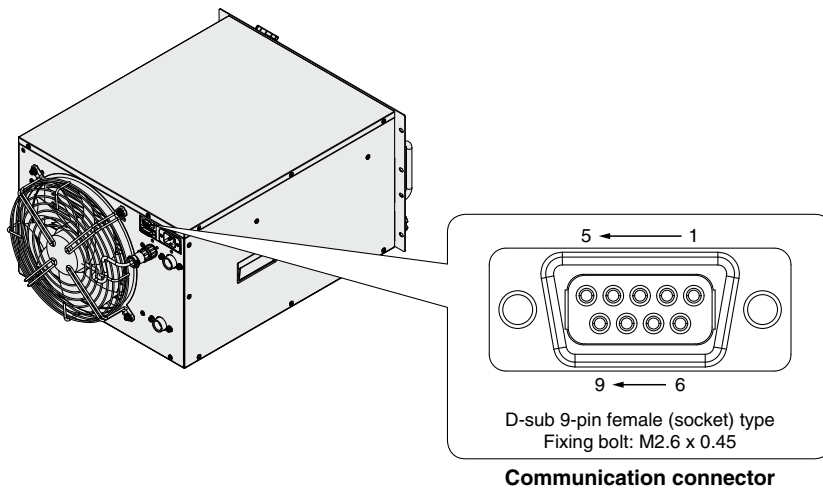

HRR Series Options

* Options have to be selected when ordering the thermo-chiller. It is not possible to add them after purchasing the unit.

DM Option symbol

With Electric Conductivity Control Function, Applicable to DI Water Piping

HRR []-[]-[]-[]-DM

• With electric conductivity control function, Applicable to DI water piping

By entering the set value of electric conductivity and hysteresis, flow of circulating fluid to the DI filter is controlled by the solenoid valve to control electric conductivity. Contact material of the circulating fluid circuit is made from non-copper materials. (For details, refer to Option M.)

Applicable model	HRR010/012/018/024/030/050-[]-[]-[]-DM
Measurement range of electric conductivity	0.1 to 48.0 $\mu\text{S/cm}$
Set range of target electric conductivity	0.5 to 45.0 $\mu\text{S/cm}^{*1}$
Set range of electric conductivity hysteresis	0.1 to 10.0 $\mu\text{S/cm}$

*1 Default setting is set to "Electric conductivity set value: 25.0 $\mu\text{S/cm}$ " and "Hysteresis: 5.0 $\mu\text{S/cm}$."

Example of operation of electric conductivity control

- Electric conductivity target value : 25.0 [$\mu\text{S/cm}$]
- Electric conductivity control hysteresis: 5.0 [$\mu\text{S/cm}$]

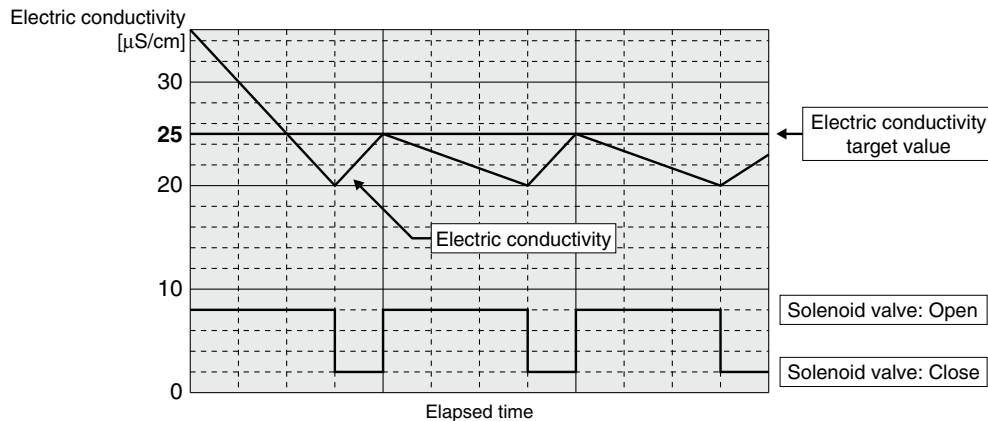

M Option symbol

Applicable to DI Water Piping

HRR []-[]-[]-[]-M

• Applicable to DI water piping

Contact material of the circulating fluid circuit is made from non-copper materials.

- Available DI water is electric conductivity: 0.4 $\mu\text{S/cm}$ or more. (Electric resistivity: 2.5 $\text{M}\Omega\cdot\text{cm}$ or less)
- This Option M does not have electric resistance/electric conductivity control function. If this function is necessary, Option DM should be selected.

Applicable model	HRR010/012/018/024/030/050-[]-[]-[]-M
Contact material for circulating fluid	Stainless steel (including heat exchanger brazing), Alumina ceramic, SiC, Carbon, PP, PE, POM, PA, FKM, EPDM, PVC, PPS, AS

* No change in external dimensions

HRR Series

* Options have to be selected when ordering the thermo-chiller.
It is not possible to add them after purchasing the unit.

T1 Option symbol Inverter Pump Mounted

HRR□-□□-□-**T1**

● Inverter pump mounted

Possible to choose an inverter pump in accordance with user's piping resistance

Cooling capacity will decrease by heat generated in the pump.

· The inverter pump does not use a mechanical seal.

· The 50 Hz and the 60 Hz inverter pumps have the same capacity. (There is no pump capacity difference between the 50 Hz and the 60 Hz.)

Applicable model		HRR010-□□-10-T1	HRR010-□□-20-T1	HRR012/018/024/030-□□-20-T1	HRR050-□□-40-T1
Pump	Rated flow (50/60 Hz)*1, *2	5 (0.35 MPa)			
	Max. pump head (50/60 Hz)	35	35	40	50
	Output	400	400	400	400
Circuit protector	A	15	10	15	10
Recommended earth leakage breaker capacity	A	15	10	15	10
Cooling capacity*3	W	The cooling capacity reduces about 400 W from the value in the catalog. Due to an increase in the heat generation of the pump			—

*1 The capacity at the thermo-chiller outlet when the circulating fluid temperature is 20°C

*2 Required minimum flow rate for maintaining the cooling capacity or temperature stability

*3 Cooling capacity will decrease as pump power increases.

* If the inverter pump mounted type is selected, the product weight of the HRR010 will increase by 2 kg, and the product weight of the HRR012 to 030 will decrease by 1 kg.

* No change in external dimensions of this product

Pump Capacity

HRR010-□□-□-**T1**

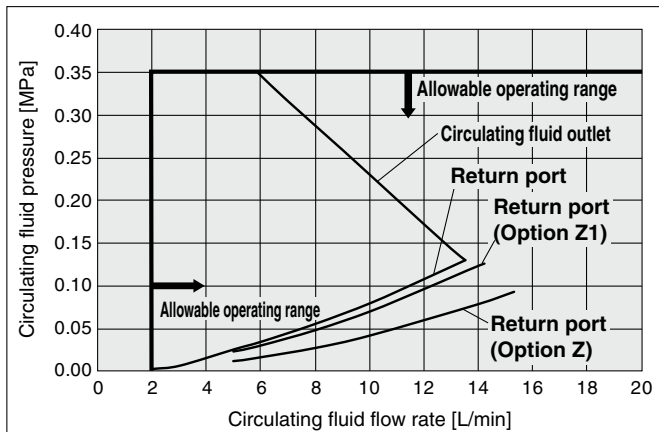

HRR012/018/024/030-□□-**20-T1**

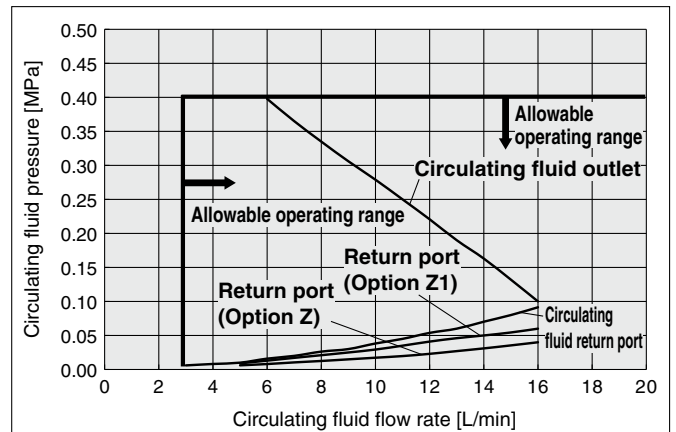

* For Options "-Z" and "-Z1," operate within the range in which AL17 (flow rate failure) is not generated.

HRR050-□□-**40-T1**

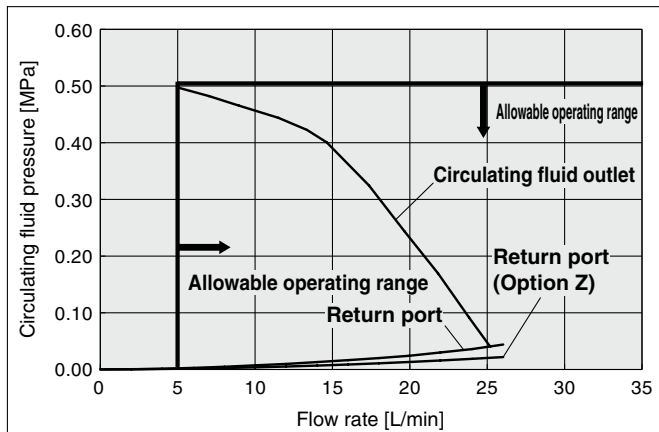

* For Options "-Z" and "-Z1," operate within the range in which AL17 (flow rate failure) is not generated.

T2 Option symbol**High-pressure Inverter Pump Mounted****HRR050-□□-40-T2**● **High-pressure inverter pump mounted**

Possible to choose a high-pressure inverter pump in accordance with user's piping resistance

Cooling capacity will decrease by heat generated in the pump.

· The inverter pump does not use a mechanical seal.

· The 50 Hz and the 60 Hz inverter pumps have the same capacity. (There is no pump capacity difference between the 50 Hz and the 60 Hz.)

Applicable model		HRR050-□□-40-T2	
Pump	Rated flow (50/60 Hz)*1, *2	L/min	24 (0.4 MPa)
	Max. pump head (50/60 Hz)	m	50
	Output	W	750
	Recommended earth leakage breaker capacity	A	10
	Cooling capacity*3	W	The cooling capacity reduces about 400 W from the value in the catalog. Due to an increase in the heat generation of the pump

*1 The capacity at the thermo-chiller outlet when the circulating fluid temperature is 20°C

*2 Required minimum flow rate for maintaining the cooling capacity or temperature stability

*3 Cooling capacity will decrease as pump power increases.

* No change in external dimensions of this product

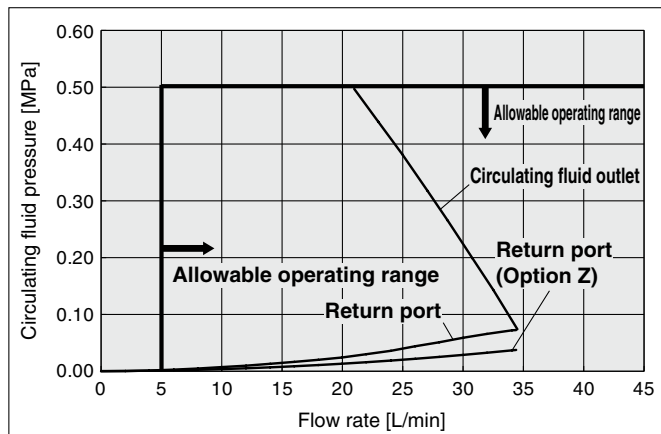
Pump Capacity**HRR050-□□-40-T2**

* For Options "-Z" and "-Z1," operate within the range in which AL17 (flow rate failure) is not generated.

T Option symbol High-Pressure Pump Mounted

HRR □□-□□-□□-**T/MT**

● High-pressure pump mounted

Possible to choose a high-pressure pump in accordance with user's piping resistance
Cooling capacity will decrease by heat generated in the pump.

- The high-pressure pump uses a mechanical seal.
- The thermo-chiller indicates maintenance notification when driving time is passed a recommended preventive maintenance hours.
Please contact to service center to ask for maintenance of the pump and mechanical seal.

Applicable model		HRR012/018-□□-10-T/MT*1	HRR012/018/024/030-□□-20-T	HRR012/018/024/030-□□-20-MT*1	
Pump	Rated flow (50/60 Hz)*2, 3	L/min	7 (0.36 MPa)/10 (0.42 MPa)	10 (0.42 MPa)/14 (0.40 MPa)	10 (0.32 MPa)/14 (0.32 MPa)
	Maximum pump head (50/60 Hz)	m	50	50	50
	Output	W	350	550	
Circuit protector		A	15 (10 A for standard)		
Recommended earth leakage breaker capacity		A	15		
Cooling capacity*4		W	The cooling capacity reduces about 300 W from the value in the catalog. (due to an increase in the heat generation of the pump)		

- *1 Option MT: Applicable to DI water piping + High-pressure pump mounted
- *2 The capacity at the thermo-chiller outlet when the circulating fluid temperature is 20°C
- *3 Required minimum flow rate for maintaining the cooling capacity or temperature stability
- *4 Cooling capacity will decrease as pump power increases.
- * When the option, high-pressure pump mounted, is selected, the product weight increases by 5 kg.
- * No change in external dimensions of this product

Pump Capacity

HRR012/018-□□-10-T/MT

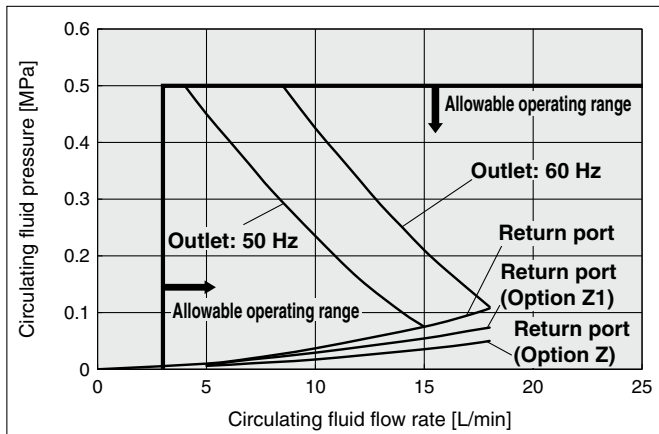

HRR012/018/024/030-□□-20-T

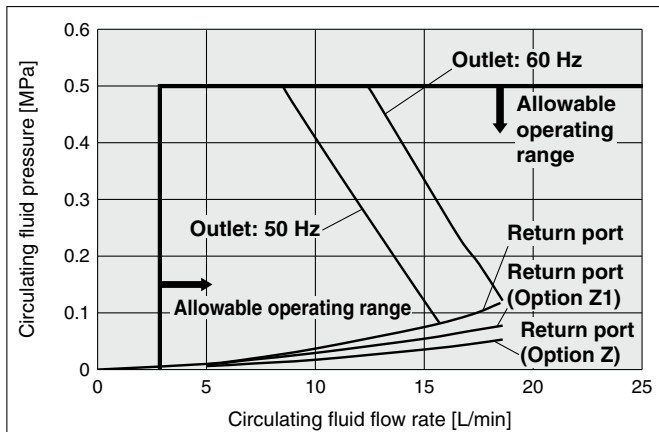

HRR012/018/024/030-□□-20-MT

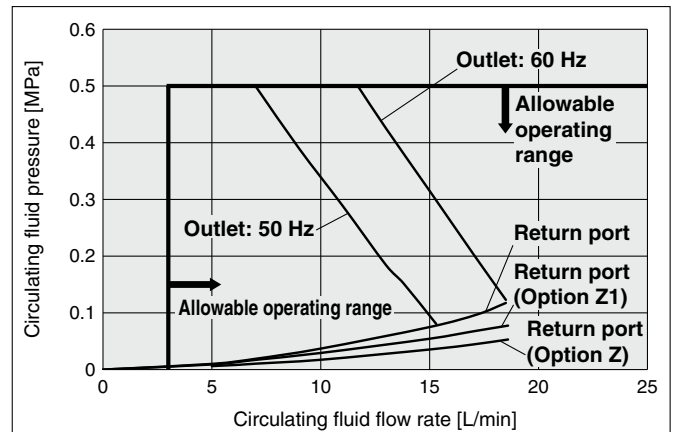

HRR Series

* Options have to be selected when ordering the thermo-chiller. It is not possible to add them after purchasing the unit.

Y Option symbol With Feet/Without Rack Mounting Brackets

Air-cooled refrigeration HRR [] - A [] - [] - [] (U) Y

Water-cooled refrigeration HRR [] - W [] - [] - [] U Y

● With feet/Without rack mounting brackets

Instead of the 19-inch rack mounting brackets, the product comes with rubber legs under its base.

Model	Dimension [mm]
	A
HRR010-[]-[]-[]Y	247
HRR012/018-[]-[]-[]Y	334
HRR024/030-[]-20-[]Y	423
HRR050-W-20-Y	554
HRR050-A-20-Y	732
HRR050-[]-40-Y	732

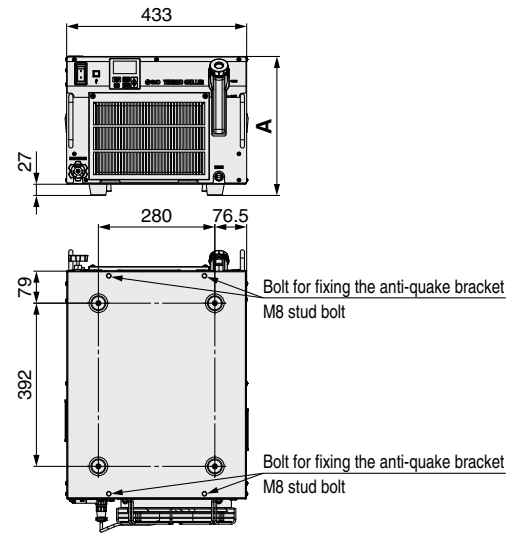

Z Option symbol Removed Parts

Air-cooled refrigeration HRR [] - A [] - [] - [] (U) Z/Z1

Water-cooled refrigeration HRR [] - W [] - [] - [] U Z/Z1

● Removed parts

Standard product without the parts below

Z	Flow sensor, Water leakage sensor, Particle filter, Bypass valve, Retaining clip*1
Z1	Flow sensor, Retaining clip*1

*1 Only for the HRR010 to 030

HRR Series

Optional Accessories

① Concentration Meter

This meter can be used to control the concentration of ethylene glycol aqueous solution regularly.

Part number	Applicable model
HRZ-BR002	HRR010/012/018/024/030/050

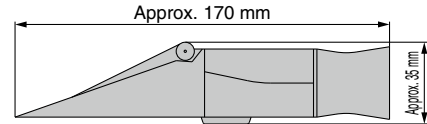

② Particle Filter Element for Replacement

Element for the maintenance of the particle filter for circulating fluid

Part number	Applicable model
HRR-PF001	HRR010
EJ202S-005X11	HRR012/018-□□-10 HRR012/018/024/030-□□-20
EJ302S-005X11	HRR050

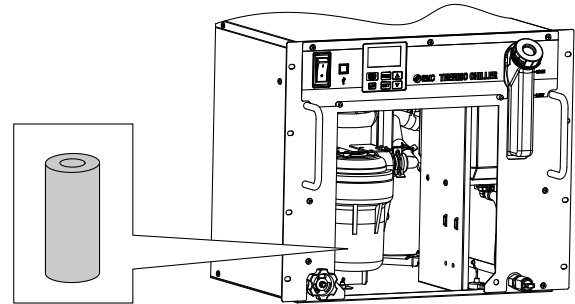

③ DI Filter Replacement Cartridge

DI filter cartridge for replacement for Option DM [Electric conductivity control type, DI water piping type]

Part number	Applicable model
HRR-DF001	HRR010/012/018-□□-10-DM□ HRR010/012/018/024/030-□□-20-DM□
HRR-DF002	HRR050-□□-□-DM□

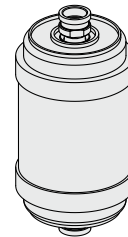

④ Anti-quake Bracket

Bracket for earthquakes

Prepare the anchor bolts (M8) which are suited to the floor material by the customer. (Anti-quake bracket material: Stainless steel, thickness: 1.5 mm)

Part number	Applicable model
HRR-TK001	HRR010/012/018-□□-□-□Y HRR024/030-□□-□-□Y HRR050-□□-□-□Y

Parts List

Description	Qty.
Anti-quake bracket A	2
Anti-quake bracket B	2
Nut (M8)	4
Bolt (M8)	4

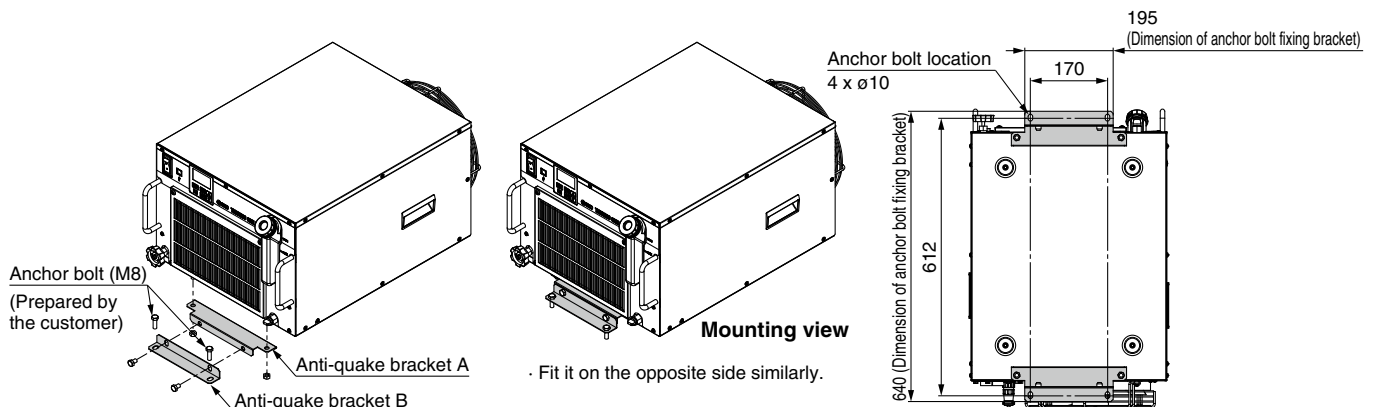

HRR Series

⑤ Piping Conversion Fitting (For Air-cooled Refrigeration)

■ Conversion fitting for circulating fluid + Conversion fitting for drain outlet

This fitting changes the port size for circulating fluid from Rc1/2 to G1/2 or NPT1/2, and for drain from Rc1/4 to G1/4 or NPT1/4. It is not necessary to purchase this when pipe thread type F or N is selected in "How to Order" since it is included in the product.

Part number	Applicable model
HRR-EP001	G thread conversion fitting set
HRR-EP002	NPT thread conversion fitting set

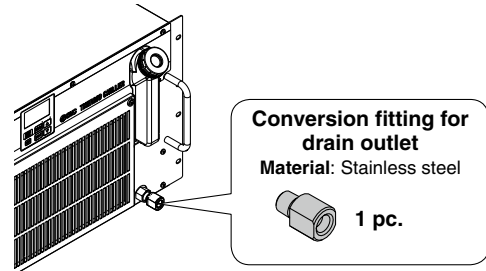
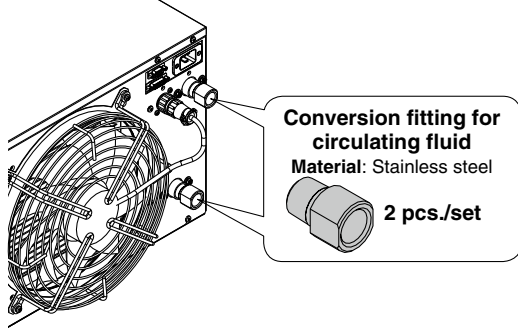

⑥ Piping Conversion Fitting (For Water-cooled Refrigeration)

■ Conversion fitting for circulating fluid + Conversion fitting for drain outlet

This fitting changes the port size for circulating fluid from Rc1/2 to G1/2 or NPT1/2, and for drain from Rc1/4 to G1/4 or NPT1/4. It is not necessary to purchase this when pipe thread type F or N is selected in "How to Order" since it is included in the product.

Part number	Applicable model
HRR-EP003	G thread conversion fitting set
HRR-EP004	NPT thread conversion fitting set

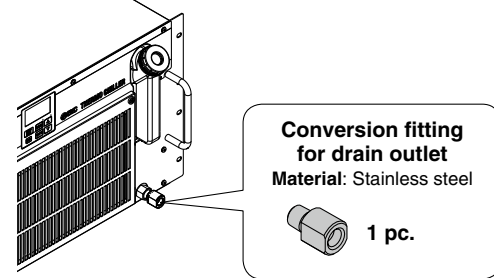
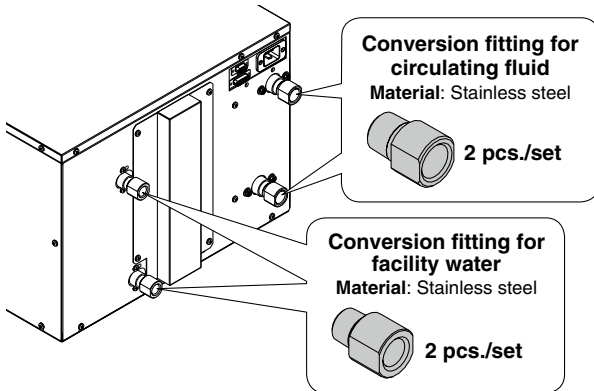

⑦ Power Supply Cable

Part number	Applicable model
HRR-CA001	HRR010/012/018-□□-10 HRR010/012/018/024/030-□□-20

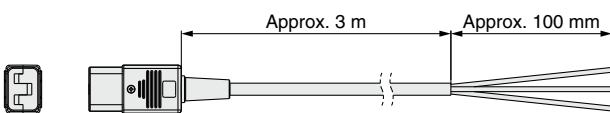

Part number	Applicable model
HRR-CA002	HRR050-□□-20

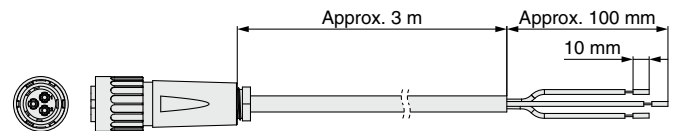

Part number	Applicable model
HRR-CA003	HRR050-□□-40

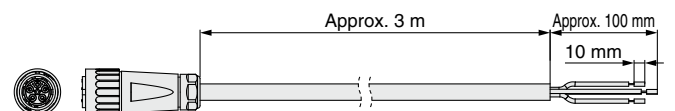

⑧ Caster Adjuster-foot Kit

This is a set of unfixed casters and adjuster feet stop.
 This kit can only be used for Option Y of the thermo-chiller HRR series.
 Do not mount this kit on other products.
 Carefully read the procedure manual included with this kit before performing the installation.

Part number	Applicable model	A dimension [mm]	Weight [kg]
HRR-KS001	HRR010-□□-□-□UY	330	Approx. 7
	HRR012/018-□□-10-□UY	417	
	HRR012/018-□□-20-□Y		
	HRR024/030-□□-20-□Y	506	
	HRR050-A□-20-□UY	815	
	HRR050-□□-40-□UY		
HRR050-W□-20-□UY	637		

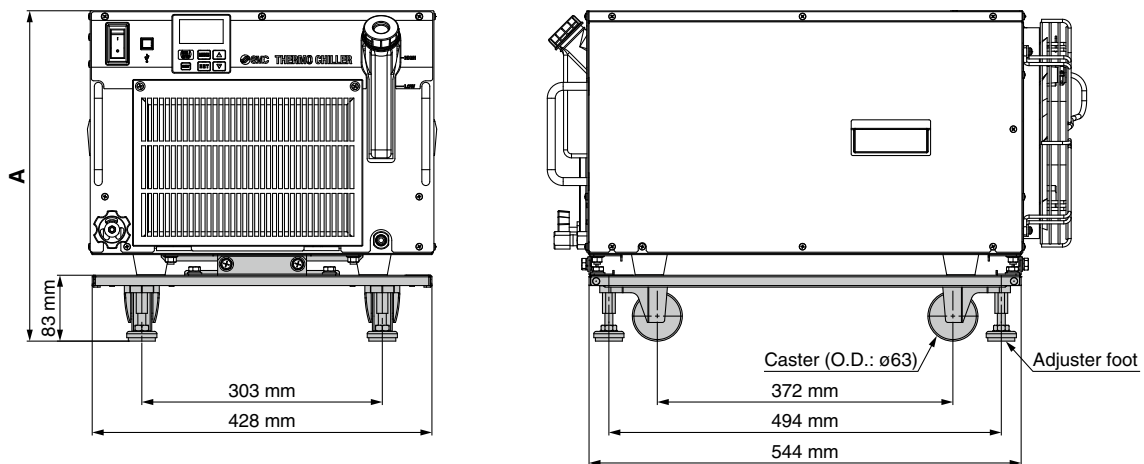

Mounting view (HRR012/018-A-□)

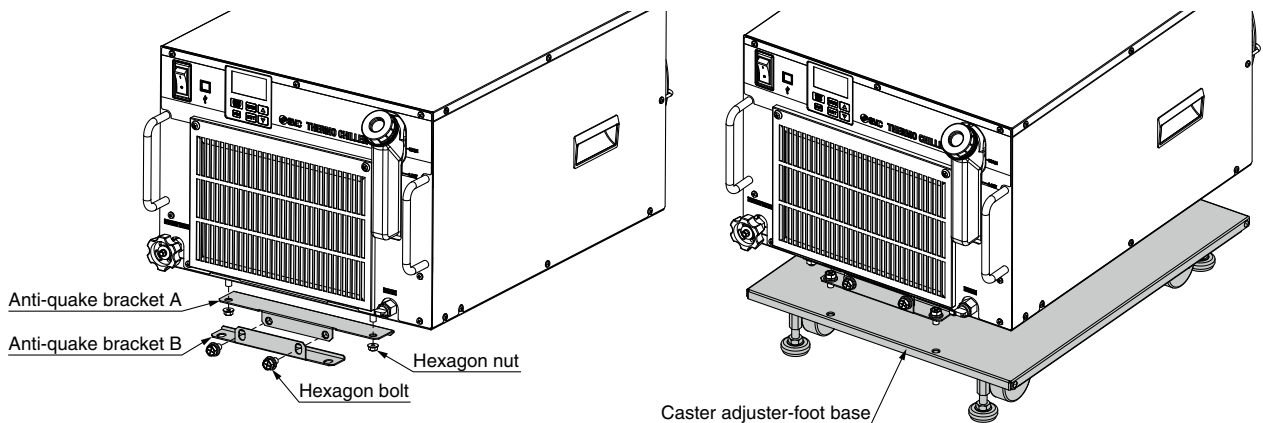

Mounting view

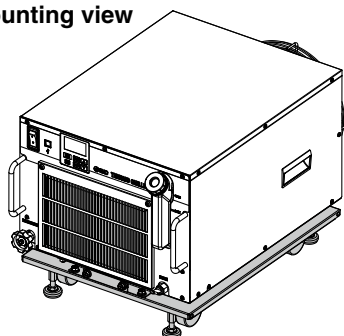

Parts List

Description	Qty.
Caster adjuster-foot base	1
Anti-quake bracket A	2
Anti-quake bracket B	2
Hexagon nut (M8)	4
Hexagon bolt (M8)	8
Mounting procedure manual	1

Cooling Capacity Calculation

Required Cooling Capacity Calculation

Example 1: When the heat generation amount in the user's equipment is known.

The heat generation amount can be determined based on the power consumption or output of the heat generating area — i.e. the area requiring cooling — within the user's equipment.*1

Q: Heat generation amount

① Derive the heat generation amount from the power consumption.

Power consumption P: 1000 [W]

$$Q = P = 1000 \text{ [W]}$$

Cooling capacity = Considering a safety factor of 20%,

$$1000 \text{ [W]} \times 1.2 = \boxed{1200 \text{ [W]}}$$

② Derive the heat generation amount from the power supply output.

Power supply output VI: 1.0 [kVA]

$$Q = P = V \times I \times \text{Power factor}$$

In this example, using a power factor of 0.85:

$$= 1.0 \text{ [kVA]} \times 0.85 = 0.85 \text{ [kW]} = 850 \text{ [W]}$$

Cooling capacity = Considering a safety factor of 20%,

$$850 \text{ [W]} \times 1.2 = \boxed{1020 \text{ [W]}}$$

③ Derive the heat generation amount from the output.

Output (shaft power, etc.) W: 800 [W]

$$Q = P = \frac{W}{\text{Efficiency}}$$

In this example, using an efficiency of 0.7:

$$= \frac{800}{0.7} = 1143 \text{ [W]}$$

Cooling capacity = Considering a safety factor of 20%,

$$1143 \text{ [W]} \times 1.2 = \boxed{1372 \text{ [W]}}$$

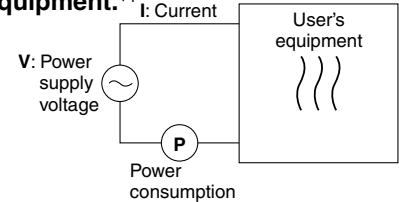

*1 The examples above calculate the heat generation amount based on the power consumption. The actual heat generation amount may differ due to the structure of the user's equipment. Be sure to check it carefully.

Example 2: When the heat generation amount in the user's equipment is not known.

Obtain the temperature difference between inlet and outlet by circulating the circulating fluid inside the user's equipment.

- Heat generation amount by user's equipment Q : Unknown [W] ([J/s])
- Circulating fluid : Tap water*1
- Circulating fluid mass flow rate q_m : ($= \rho \times q_v \div 60$) [kg/s]
- Circulating fluid density ρ : 1 [kg/dm³]
- Circulating fluid (volume) flow rate q_v : 10 [dm³/min]
- Circulating fluid specific heat C : 4.2×10^3 [J/(kg·K)]
- Circulating fluid outlet temperature T₁ : 293 [K] (20 [°C])
- Circulating fluid return temperature T₂ : 295 [K] (22 [°C])
- Circulating fluid temperature difference ΔT : 2.0 [K] ($= T_2 - T_1$)
- Conversion factor: minutes to seconds (SI units) : 60 [s/min]

*1 Refer to page 40 for the typical physical property value of tap water or other circulating fluids.

$$Q = q_m \times C \times (T_2 - T_1)$$

$$= \frac{\rho \times q_v \times C \times \Delta T}{60} = \frac{1 \times 10 \times 4.2 \times 10^3 \times 2.0}{60}$$

$$= 1400 \text{ [J/s]} \approx 1400 \text{ [W]}$$

Cooling capacity = Considering a safety factor of 20%,

$$1400 \text{ [W]} \times 1.2 = \boxed{1680 \text{ [W]}}$$

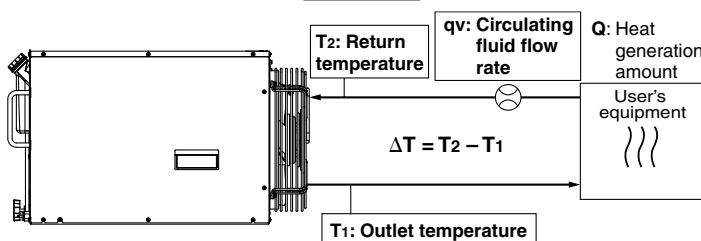

Example of conventional units (Reference)

- Heat generation amount by user's equipment Q : Unknown [cal/h] → [W]
- Circulating fluid : Tap water*1
- Circulating fluid weight flow rate q_m : ($= \rho \times q_v \times 60$) [kgf/h]
- Circulating fluid weight volume ratio γ : 1 [kgf/L]
- Circulating fluid (volume) flow rate q_v : 10 [L/min]
- Circulating fluid specific heat C : 1.0×10^3 [cal/(kgf·°C)]
- Circulating fluid outlet temperature T₁ : 20 [°C]
- Circulating fluid return temperature T₂ : 22 [°C]
- Circulating fluid temperature difference ΔT : 2.0 [°C] ($= T_2 - T_1$)
- Conversion factor: hours to minutes : 60 [min/h]
- Conversion factor: kcal/h to kW : 860 [(cal/h)/W]

$$Q = \frac{q_m \times C \times (T_2 - T_1)}{860}$$

$$= \frac{\gamma \times q_v \times 60 \times C \times \Delta T}{860}$$

$$= \frac{1 \times 10 \times 60 \times 1.0 \times 10^3 \times 2.0}{860}$$

$$= \frac{1200000 \text{ [cal/h]}}{860}$$

$$\approx 1400 \text{ [W]}$$

Cooling capacity = Considering a safety factor of 20%,

$$1400 \text{ [W]} \times 1.2 = \boxed{1680 \text{ [W]}}$$

* Calculation example for the temperature and flow rate based on customer's piping condition

For calculating the required cooling capacity based on the displayed value of temperature and flow rate in the chiller, fully close the bypass valve.

Required Cooling Capacity Calculation

Example 3: When there is no heat generation, and when cooling the object below a certain temperature and period of time.

Heat quantity by cooled substance (per unit time) **Q**: Unknown [W] [(J/s)]
 Cooled substance : Water
 Cooled substance mass **m** : (= $\rho \times V$) [kg]
 Cooled substance density ρ : 1 [kg/dm³]
 Cooled substance total volume **V** : 20 [dm³]
 Cooled substance specific heat **C** : 4.2 x 10³ [J/(kg·K)]
 Cooled substance temperature when cooling begins **To**: 305 [K] (32 [°C])
 Cooled substance temperature after t hour **Tt** : 293 [K] (20 [°C])
 Cooling temperature difference ΔT : 12 [K] (= **To** - **Tt**)
 Cooling time Δt : 900 [s] (= 15 [min])

* Refer to the following for the typical physical property values by circulating fluid.

$$Q = \frac{m \times C \times (T_o - T_t)}{\Delta t} = \frac{\rho \times V \times C \times \Delta T}{\Delta t}$$

$$= \frac{1 \times 20 \times 4.2 \times 10^3 \times 12}{900} = 1120 \text{ [J/s]} \approx 1120 \text{ [W]}$$

Cooling capacity = Considering a safety factor of 20%,

$$1120 \text{ [W]} \times 1.2 = \boxed{1344 \text{ [W]}}$$

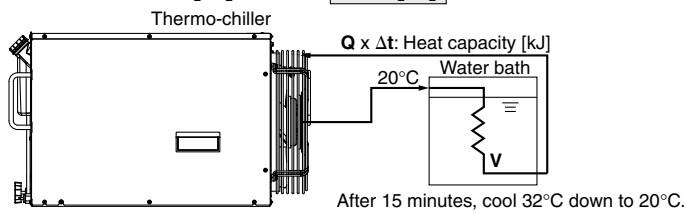

* This is the calculated value by changing the fluid temperature only.
 Thus, it varies substantially depending on the water bath or piping shape.

Example of conventional units (Reference)

Heat quantity by cooled substance (per unit time) **Q**: Unknown [cal/h] → [W]
 Cooled substance : Water
 Cooled substance weight **m** : (= $\rho \times V$) [kgf]
 Cooled substance weight volume ratio γ : 1 [kgf/L]
 Cooled substance total volume **V** : 20 [L]
 Cooled substance specific heat **C** : 1.0 x 10³ [cal/(kgf·°C)]
 Cooled substance temperature when cooling begins **To** : 32 [°C]
 Cooled substance temperature after t hour **Tt**: 20 [°C]
 Cooling temperature difference ΔT : 12 [°C] (= **To** - **Tt**)
 Cooling time Δt : 15 [min]
 Conversion factor: hours to minutes : 60 [min/h]
 Conversion factor: kcal/h to kW : 860 [(cal/h)/W]

$$Q = \frac{m \times C \times (T_o - T_t)}{\Delta t \times 860} = \frac{\gamma \times V \times 60 \times C \times \Delta T}{\Delta t \times 860}$$

$$= \frac{1 \times 20 \times 60 \times 1.0 \times 10^3 \times 12}{15 \times 860}$$

$$\approx 1120 \text{ [W]}$$

Cooling capacity = Considering a safety factor of 20%,

$$1120 \text{ [W]} \times 1.2 = \boxed{1344 \text{ [W]}}$$

Precautions on Cooling Capacity Calculation

1. Heating capacity

When the circulating fluid temperature is set above room temperature, it needs to be heated by the thermo-chiller. The heating capacity depends on the circulating fluid temperature. Consider the radiation rate and heat capacity of the user's equipment and check beforehand if the required heating capacity is provided.

2. Pump capacity

<Circulating fluid flow rate>

Circulating fluid flow rate varies depending on the circulating fluid discharge pressure. Consider the installation height difference between the thermo-chiller and the user's equipment, and the piping resistance such as circulating fluid pipings, or piping size, or piping curves in the machine. Check beforehand if the required flow is achieved, using the pump capacity curves.

<Circulating fluid discharge pressure>

Circulating fluid discharge pressure has the possibility to increase up to the maximum pressure in the pump capacity curves. Check beforehand if the circulating fluid pipings or circulating fluid circuit of the user's equipment are fully durable against this pressure.

Circulating Fluid Typical Physical Property Values

1. This catalog uses the following values for density and specific heat in calculating the required cooling capacity.

Density ρ : 1 [kg/dm³] (or, using conventional units, weight volume ratio $\gamma = 1$ [kgf/L])
 Specific heat **C**: 4.19 x 10³ [J/(kg·K)] (or, using conventional units, 1 x 10³ [cal/(kgf·°C)])

2. Values for density and specific heat change slightly according to temperature shown below. Use this as a reference.

Water

Physical property value Temperature	Density ρ [kg/dm ³]	Specific heat C [J/(kg·K)]	Conventional units	
			Weight volume ratio γ [kgf/L]	Specific heat C [cal/(kgf·°C)]
5°C	1.00	4.2 x 10 ³	1.00	1 x 10 ³
10°C	1.00	4.19 x 10 ³	1.00	1 x 10 ³
15°C	1.00	4.19 x 10 ³	1.00	1 x 10 ³
20°C	1.00	4.18 x 10 ³	1.00	1 x 10 ³
25°C	1.00	4.18 x 10 ³	1.00	1 x 10 ³
30°C	1.00	4.18 x 10 ³	1.00	1 x 10 ³
35°C	0.99	4.18 x 10 ³	0.99	1 x 10 ³
40°C	0.99	4.18 x 10 ³	0.99	1 x 10 ³

15% Ethylene Glycol Aqueous Solution

Physical property value Temperature	Density ρ [kg/dm ³]	Specific heat C [J/(kg·K)]	Conventional units	
			Weight volume ratio γ [kgf/L]	Specific heat C [cal/(kgf·°C)]
5°C	1.02	3.91 x 10 ³	1.02	0.93 x 10 ³
10°C	1.02	3.91 x 10 ³	1.02	0.93 x 10 ³
15°C	1.02	3.91 x 10 ³	1.02	0.93 x 10 ³
20°C	1.01	3.91 x 10 ³	1.01	0.93 x 10 ³
25°C	1.01	3.91 x 10 ³	1.01	0.93 x 10 ³
30°C	1.01	3.91 x 10 ³	1.01	0.94 x 10 ³
35°C	1.01	3.91 x 10 ³	1.01	0.94 x 10 ³
40°C	1.01	3.92 x 10 ³	1.01	0.94 x 10 ³

* Shown above are reference values. Contact circulating fluid supplier for details.



HRR Series Specific Product Precautions 1

Be sure to read this before handling the products. Refer to the back cover for safety instructions. For temperature control equipment precautions, refer to the “Handling Precautions for SMC Products” and the “Operation Manual” on the SMC website: <https://www.smcworld.com>

Design

Warning

- This catalog shows the specifications of a single unit.**
 - Check the specifications of the single unit (contents of this catalog) and thoroughly consider the adaptability between the user's system and this unit.
 - Although a protection circuit as a single unit is installed, prepare a drain pan, water leakage sensor, discharge air facility, and emergency stop equipment, depending on the user's operating conditions. Also, the user is requested to carry out a safety design for the whole system.

- When attempting to cool areas that are open to the atmosphere (tanks, pipes), plan your piping system accordingly.**

When cooling open-air external tanks, arrange the piping so that there are coil pipes for cooling inside the tanks and to carry back the entire flow volume of circulating fluid that is released.

- Use non-corrosive material for circulating fluid contact parts.**

The recommended circulating fluid is tap water or 15% ethylene glycol aqueous solution. Using corrosive materials such as aluminum or iron for fluid contact parts such as piping may cause clogging or leakage in the circulating fluid circuit. Therefore, take sufficient care when selecting fluid contact part materials such as piping.

- Design the piping so that no foreign matter enters the chiller.**

If foreign matter, such as scales in the piping, enters the circulating fluid, this may cause the pump to malfunction.

Selection

Warning

- Model selection**

When selecting a thermo-chiller model, the amount of heat generation from the user's equipment must be known. Obtain this value, referring to “Cooling Capacity Calculation” on pages 39 and 40 before selecting a model.

Handling

Warning

- Thoroughly read the operation manual.**

Read the operation manual completely before operation. Also, keep the manual where it can be referred to as necessary.

Transportation / Carriage / Movement

Warning

- This product is heavy. Pay attention to safety and the position of the product when it is transported, carried, and moved.**
- Read the operation manual carefully before moving the product after unpacking.**

Transportation / Carriage / Movement

Caution

- Never put the product down on its side as this may cause failure.**

The product will be delivered in the packaging shown below.

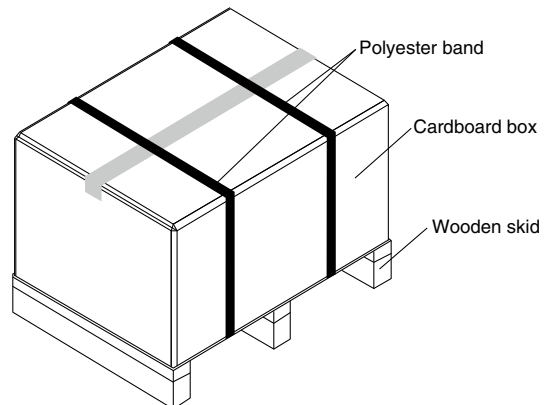

Model	Weight [kg]*1	Dimensions [mm]
HRR010-A	43	Height 485 x Width 610 x Depth 820
HRR010-W	41	
HRR012-A HRR018-A	54	Height 575 x Width 610 x Depth 820
HRR012-W HRR018-W	55	
HRR024-A HRR030-A	61	Height 665 x Width 610 x Depth 820
HRR024-W HRR030-W	60	
HRR050-A-20	91	Height 975 x Width 610 x Depth 820
HRR050-W-20	80	Height 800 x Width 610 x Depth 820
HRR050-A-40	84	Height 975 x Width 610 x Depth 820
HRR050-W-40	78	

* For models with an option, the weight increases as shown below.

Option	Description	Product series	Additional weight
-DM	With electric conductivity control function, Applicable to DI water piping	All series	+1 kg
-M	Applicable to DI water piping	All series	Not changed
-T1	Inverter pump mounted	HRR010	+2 kg
		HRR012 to 030	-1 kg
		HRR050-□-40	Not changed
-T2	High-pressure inverter pump mounted	HRR050-□-40	Not changed
-T	High-pressure pump mounted	All series	+5 kg
-U	Compliant with UL Standards	All series	Not changed
-Y	With feet/Without rack mounting brackets	All series	Not changed
-Z	Without either a flow sensor, water leakage sensor, particle filter, bypass valve or retaining clip	HRR010	Not changed
		HRR012 to 030	-1 kg
		HRR050	-2 kg
-Z1	Without either a flow sensor or retaining clip	All series	Not changed

Caution

If this product is to be transported after delivery, please use the original packaging the product was delivered in. If other packaging is to be used, carefully package the product so as to prevent the product from incurring any damage during transport.



HRR Series

Specific Product Precautions 2

Be sure to read this before handling the products. Refer to the back cover for safety instructions. For temperature control equipment precautions, refer to the “Handling Precautions for SMC Products” and the “Operation Manual” on the SMC website: <https://www.smcworld.com>

Operating Environment / Storage Environment

Warning

1. Do not use in the following environment as it will lead to a breakdown.

- 1) Outdoors
- 2) In locations where water, water vapor, salt water, and oil may splash on the product
- 3) In locations where there are dust and particles
- 4) In locations where corrosive gases, organic solvents, chemical fluids, or flammable gases are present (This product is not explosion proof.)
- 5) In locations where the ambient temperature exceeds the limits as mentioned below
 - During transportation/storage: 0 to 50°C (But as long as water or circulating fluid are not left inside the pipings)
 - During operation: 5 to 40°C
- 6) In locations where the ambient humidity is out of the following range or where condensation occurs
 - During transportation/storage: 15 to 85%
 - During operation: 30 to 70%
- 7) In locations which receive direct sunlight or radiated heat
- 8) In locations where there is a heat source nearby and the ventilation is poor
- 9) In locations where temperature substantially changes
- 10) In locations where strong magnetic noise occurs (In locations where strong electric fields, strong magnetic fields, and surge voltage occur)
- 11) In locations where static electricity occurs, or conditions which make the product discharge static electricity
- 12) In locations where high frequency occurs
- 13) In locations where damage is likely to occur due to lightning
- 14) In locations at an altitude of 3000 m or higher (Excluding: storage and transportation)
 - * For altitudes of 1000 m or higher

Because of lower air density, the heat radiation efficiencies of the devices in the product will be lower in the location at an altitude of 1000 m or higher. Therefore, the maximum ambient temperature to use and the cooling capacity will lower according to the descriptions in the table below.

Select the thermo-chiller considering the descriptions.

- ① Upper limit of ambient temperature: Use the product in ambient temperature of the described value or lower at each altitude.
- ② Cooling capacity coefficient: The product's cooling capacity will lower to one that multiplied by the described value at each altitude.

Altitude [m]	① Upper limit of ambient temperature [°C]		② Cooling capacity coefficient
	40°C products		
Less than 1000 m	40		1.00
Less than 1500 m	38		0.85
Less than 2000 m	36		0.80
Less than 2500 m	34		0.75
Less than 3000 m	32		0.70

- 15) In locations where strong impacts or vibrations occur
- 16) In locations where a massive force strong enough to deform the product is applied or the weight from a heavy object is applied
- 17) In locations where there is not sufficient space for maintenance

2. Install in an environment where the unit will not come into direct contact with rain or snow.

These models are for indoor use only. Do not install outdoors where rain or snow may fall on them.

3. Conduct ventilation and cooling to discharge heat. (Air-cooled refrigeration)

The heat which is cooled down through air-cooled condenser is discharged. When using in a room which is shut tightly, ambient temperature will exceed the specification range stipulated in this catalog, which will activate the safety detector and stop the operation. In order to avoid this situation, discharge the heat outside of a room by ventilation or cooling facilities.

4. The product is not designed for clean room usage. It generates particles internally.



HRR Series Specific Product Precautions 3

Be sure to read this before handling the products. Refer to the back cover for safety instructions. For temperature control equipment precautions, refer to the "Handling Precautions for SMC Products" and the "Operation Manual" on the SMC website: <https://www.smcworld.com>

Mounting / Installation

Warning

1. Do not use the product outdoors.
2. Do not place heavy objects on top of this product, or step on it.

The external panel can be deformed and danger can result.

Caution

1. Make sure that the rack and the rack rail can support the weight of the product. In addition, if this product is to be mounted on a rack, design it so that the weight of the product can be held from below. 1U of space is recommended between this product and other equipment.
2. Refer to the operation manual for this product, and secure an installation space that is necessary for the maintenance and ventilation.

<Air-cooled refrigeration>

1. The air-cooled type product exhausts heat using the fan that is mounted to the product. If the product is operated with insufficient ventilation, ambient temperature may exceed 40°C, and this will affect the performance and life of the product. To prevent this ensure that suitable ventilation is available (see below).
2. For installation indoors, ventilation ports and a ventilation fan should be equipped as needed.

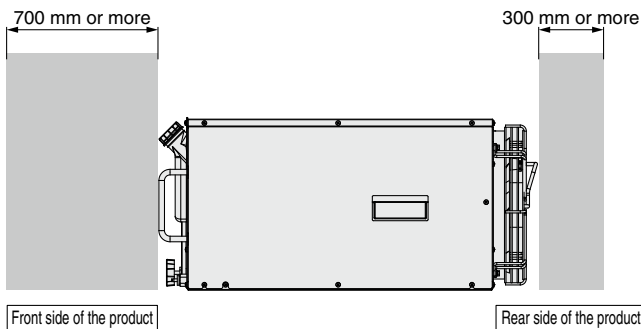

<Heat radiation amount/Required ventilation rate>

Model	Heat radiation amount [kW]	Required ventilation rate [m ³ /min]	
		Differential temp. of 3°C between inside and outside of installation area	Differential temp. of 6°C between inside and outside of installation area
HRR010-A	Approx. 2	40	20
HRR012-A	Approx. 2	40	20
HRR018-A	Approx. 4	70	40
HRR024-A	Approx. 5	90	50
HRR030-A	Approx. 6	100	60
HRR050-A	Approx. 10	140	70

Piping

Caution

1. The circulating fluid and facility water piping should be prepared by the customer with consideration of the operating pressure, temperature, and circulating fluid/facility compatibility.

If the operating performance is not sufficient, the pipings may burst during operation. Also, the use of corrosive materials such as aluminum or iron for fluid contact parts, such as piping, may not only lead to clogging or leakage in the circulating fluid and facility water circuits but also refrigerant leakage and other unexpected problems. Provide protection against corrosion when you use the product.

2. Select the piping port size which can exceed the rated flow.
For the rated flow, refer to the pump capacity table.
3. When tightening at the circulating fluid inlet and outlet, drain port or overflow port of this product, use a pipe wrench to clamp the connection ports.

4. This product series are constant-temperature fluid circulating machines with built-in tanks.

Do not install equipment on your system side such as pumps that forcibly return the circulating fluid to the unit. Also, if you attach an external tank that is open to the air, it may become impossible to circulate the circulating fluid. Proceed with caution.

5. The facility water flow rate is adjusted automatically according to the operating conditions. In addition, the facility water return temperature is 60°C at maximum.

Electrical Wiring

Warning

1. Grounding should never be connected to a water line, gas line or lightning rod.

Caution

1. Communication cable should be prepared by the customer.
2. Provide a stable power supply which is not affected by surge or distortion.

If the voltage increase ratio (dV/dt) at the zero cross should exceed 40 V/200 μ sec., it may result in malfunction.

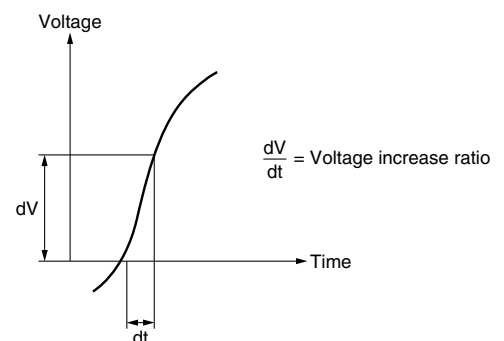



HRR Series Specific Product Precautions 4

Be sure to read this before handling the products. Refer to the back cover for safety instructions. For temperature control equipment precautions, refer to the “Handling Precautions for SMC Products” and the “Operation Manual” on the SMC website: <https://www.smcworld.com>

Circulating Fluid

⚠ Caution

1. Avoid oil or other foreign matter entering the circulating fluid.
2. When water is used as a circulating fluid, use tap water that conforms to the appropriate water quality standards.

Use tap water that conforms to the standards shown below (including water used for dilution of ethylene glycol aqueous solution).

Tap Water (as a Circulating Fluid) Quality Standards

The Japan Refrigeration and Air Conditioning Industry Association
JRA GL-02-1994 “Cooling water system – Circulation type – Make-up water”

	Item	Unit	Standard value	Influence	
				Corrosion	Scale generation
Standard item	pH (at 25°C)	—	6.0 to 8.0	○	○
	Electric conductivity (25°C)	[μS/cm]	100*1 to 300*1	○	○
	Chloride ion (Cl ⁻)	[mg/L]	50 or less	○	
	Sulfuric acid ion (SO ₄ ²⁻)	[mg/L]	50 or less	○	
	Acid consumption amount (at pH4.8)	[mg/L]	50 or less		○
	Total hardness	[mg/L]	70 or less		○
	Calcium hardness (CaCO ₃)	[mg/L]	50 or less		○
Reference item	Ionic state silica (SiO ₂)	[mg/L]	30 or less		○
	Iron (Fe)	[mg/L]	0.3 or less	○	○
	Copper (Cu)	[mg/L]	0.1 or less	○	
	Sulfide ion (S ₂ ⁻)	[mg/L]	Should not be detected	○	
	Ammonium ion (NH ₄ ⁺)	[mg/L]	0.1 or less	○	
	Residual chlorine (Cl)	[mg/L]	0.3 or less	○	
	Free carbon (CO ₂)	[mg/L]	4.0 or less	○	

*1 In the case of [MΩ·cm], it will be 0.003 to 0.01.

- : Factors that have an effect on corrosion or scale generation
- Even if the water quality standards are met, complete prevention of corrosion is not guaranteed.

3. Use an ethylene glycol aqueous solution that does not contain additives such as preservatives.

4. When using ethylene glycol aqueous solution, maintain a maximum concentration of 15%.

Overly high concentrations can cause a pump overload. Low concentrations, however, can lead to freezing when circulating fluid temperature is 10°C or lower and cause the thermo-chiller to break down.

5. A magnet pump or mechanical seal pump is used as the circulating pump for the circulating fluid.

It is particularly impossible to use liquid including metallic powder such as iron powder.

6. The circulating fluids listed below have been tested for thermo-chiller compatibility. (Excludes the HRR010)

No.	Fluid	Manufacturer	Concentration
1	Dowcal™ 100 Heat Transfer Fluid	The Dow Chemical Company	Dilute to 30% in water
2	ControXid 1642	Oelheld GmbH	Ready to use
3	Hexid A4	Applied Thermal Control Limited	Ready to use
4	Coofflow IGE	Hydratech Division of Liquitherm Technologies Group Ltd	Dilute to 25% in water
5	NALCO® CCL105	Nalco Water, an Ecolab Company	Ready to use

- The chiller cooling capacity and pump capacity performance may change with using the fluids listed. Customers should verify the performances with the fluid and decide to use the fluid.
- Check the compatibility with the piping and the wetted parts of the customer's equipment before use.
- Check with the circulating fluid manufacturer for the following.
 - 1) Countries and regions where it can be obtained and used
 - 2) Handling and maintenance
 - 3) Safety data sheets
 - 4) Specifications and physical properties
- Concentration has to be value listed or less. Overly high concentrations can cause a pump overload. Low concentrations, however, can lead to freezing when circulating fluid temperature is 10°C or lower and cause the thermo-chiller to break down.
- Using the fluid listed for a long time, the chiller heat exchanger performance may be reduced due to additive deposits. It is recommended to regularly flush the inside of the piping and chiller with clean water.
- In the case of a mechanical seal pump, additive deposits may appear on the outside, it is not a malfunction.

Facility Water Supply

⚠ Warning

<Water-cooled refrigeration>

1. The water-cooled refrigeration type thermo-chiller radiates heat to the facility water.

Prepare the facility water system that satisfies the heat radiation and the facility water specifications below.

■ Required facility water system

<Heat radiation amount/Facility water specifications>

Model	Heat radiation [kW]	Facility water specifications
HRR010-W	Approx. 2	Refer to “Facility water system” in the specifications.
HRR012-W	Approx. 2	
HRR018-W	Approx. 4	
HRR024-W	Approx. 5	
HRR030-W	Approx. 6	
HRR050-W	Approx. 10	

2. When using tap water as facility water, use tap water that conforms to the appropriate water quality standards.

Use tap water that conforms to the standards shown below.

<Tap Water (as Facility Water) Quality Standards>

The Japan Refrigeration and Air Conditioning Industry Association
JRA GL-02-1994 “Cooling water system – Circulation type – Circulating water”

	Item	Unit	Standard value	Influence	
				Corrosion	Scale generation
Standard item	pH (at 25°C)	—	6.5 to 8.2	○	○
	Electric conductivity (25°C)	[μS/cm]	100*1 to 800*1	○	○
	Chloride ion (Cl ⁻)	[mg/L]	200 or less	○	
	Sulfuric acid ion (SO ₄ ²⁻)	[mg/L]	200 or less	○	
	Acid consumption amount (at pH4.8)	[mg/L]	100 or less		○
	Total hardness	[mg/L]	200 or less		○
	Calcium hardness (CaCO ₃)	[mg/L]	150 or less		○
Reference item	Ionic state silica (SiO ₂)	[mg/L]	50 or less		○
	Iron (Fe)	[mg/L]	1.0 or less	○	○
	Copper (Cu)	[mg/L]	0.3 or less	○	
	Sulfide ion (S ₂ ⁻)	[mg/L]	Should not be detected	○	
	Ammonium ion (NH ₄ ⁺)	[mg/L]	1.0 or less	○	
	Residual chlorine (Cl)	[mg/L]	0.3 or less	○	
	Free carbon (CO ₂)	[mg/L]	4.0 or less	○	

*1 In the case of [MΩ·cm], it will be 0.001 to 0.01.

- : Factors that have an effect on corrosion or scale generation
- Even if the water quality standards are met, complete prevention of corrosion is not guaranteed.

3. Supply pressure of 0.5 MPa or less.

If the supply pressure is high, it will cause water leakage.

4. Be sure to prepare your utilities so that the pressure of the thermo-chiller facility water outlet is at 0 MPa (atmospheric pressure) or more.

If the facility water outlet pressure becomes negative, the internal facility water piping may collapse, and proper flow control of facility water will be impossible.

Using deionized water as facility water may cause problems such as clogging in the piping due to metal ion.

5. Do not use fluid that includes metallic powders and other foreign materials.

It can cause issues: clogging of the circulating fluid circuit or leakage.



HRR Series

Specific Product Precautions 5

Be sure to read this before handling the products. Refer to the back cover for safety instructions. For temperature control equipment precautions, refer to the “Handling Precautions for SMC Products” and the “Operation Manual” on the SMC website: <https://www.smcworld.com>

Operation

Warning

1. Confirmation before operation

1) The fluid level of a tank should be within the specified range of “HIGH” and “LOW.”

When exceeding the specified level, the circulating fluid will overflow.

2) Remove the air.

Conduct a trial operation, looking at the fluid level.

Since the fluid level will go down when the air is removed from the user’s piping system, supply water once again when the fluid level is reduced. When there is no reduction in the fluid level, the job of removing the air is completed.

2. Confirmation during operation

• Check the circulating fluid temperature.

The operating temperature range of the circulating fluid is between 5 and 35°C.

When the amount of heat generated from the user’s equipment is greater than the product’s capability, the circulating fluid temperature may exceed this range. Use caution regarding this matter.

3. Emergency stop method

• When an abnormality is confirmed, stop the machine immediately. When operation is stopped by the RUN/STOP key, turn off the power switch.

Operation Restart Time/Operation and Suspension Frequency

Caution

1. Wait five minutes or more before restarting operation after it has been stopped. If the operation is restarted within five minutes, the protection circuit may activate and the operation may not start properly.

2. Operation and suspension frequency should not exceed 10 times per day. Frequently switching between operation and suspension may result in the malfunction of the refrigeration circuit.

Protection Circuit

Caution

1. If operating in the conditions below, the protection circuit will activate and an operation may not be performed or will stop.

- Power supply voltage is not within the rated voltage range of ±10%.
- In case the water level inside the tank is reduced abnormally.
- Circulating fluid temperature is too high.
- Compared to the cooling capacity, the heat generation amount of the user’s equipment is too high.
- Ambient temperature is too high. (40°C or more)
- Refrigerant pressure is too high.
- Ventilation grille is clogged with dust or dirt.

Maintenance

Caution

<Periodical inspection every one month>

1. Clean the ventilation grille.

If the dustproof filter becomes clogged with dust or debris, a decline in cooling performance can result.

In order to avoid deforming or damaging the dustproof filter, clean it with a long-haired brush or air gun.

<Periodical inspection every three months>

1. Inspect the circulating fluid.

1) When using tap water

- Replacement of tap water

Failure to replace the tap water can lead to the development of bacteria or algae. Replace it regularly depending on your usage conditions.

2) When using ethylene glycol aqueous solution

Use a concentration meter to confirm that the concentration does not exceed 15%.

Dilute or add as needed to adjust the concentration.

<Periodical inspection during the winter season>

1. Make water-removal arrangements beforehand.

If there is a risk of the circulating fluid freezing when the product is stopped, release the circulating fluid in advance.

2. Consult a professional.

For additional methods to prevent freezing (such as commercially available tape heaters, etc.), consult a professional for advice.

■ Refrigerant with GWP reference



Refrigerant	Global warming potential (GWP)	
	Regulation (EU) No 517/2014 (Based on the IPCC AR4)	Revised Fluorocarbons Recovery and Destruction Law (Japanese law)
R134a	1,430	1,430
R404A	3,922	3,920
R407C	1,774	1,770
R410A	2,088	2,090

* This product is hermetically sealed and contains fluorinated greenhouse gases (HFC). When this product is sold on the market in the EU after January 1, 2017, it needs to be compliant with the quota system of the F-Gas Regulation in the EU.

* See specification table for refrigerant used in the product.

Safety Instructions

These safety instructions are intended to prevent hazardous situations and/or equipment damage. These instructions indicate the level of potential hazard with the labels of “**Caution**,” “**Warning**” or “**Danger**.” They are all important notes for safety and must be followed in addition to International Standards (ISO/IEC), and other safety regulations.

-  **Caution:** **Caution** indicates a hazard with a low level of risk which, if not avoided, could result in minor or moderate injury.
-  **Warning:** **Warning** indicates a hazard with a medium level of risk which, if not avoided, could result in death or serious injury.
-  **Danger:** **Danger** indicates a hazard with a high level of risk which, if not avoided, will result in death or serious injury.

Warning

1. The compatibility of the product is the responsibility of the person who designs the equipment or decides its specifications.

Since the product specified here is used under various operating conditions, its compatibility with specific equipment must be decided by the person who designs the equipment or decides its specifications based on necessary analysis and test results. The expected performance and safety assurance of the equipment will be the responsibility of the person who has determined its compatibility with the product. This person should also continuously review all specifications of the product referring to its latest catalog information, with a view to giving due consideration to any possibility of equipment failure when configuring the equipment.

2. Only personnel with appropriate training should operate machinery and equipment.

The product specified here may become unsafe if handled incorrectly. The installation, operation, and maintenance of the product must be performed by an operator who is appropriately trained and experienced and who has a thorough understanding of the precautions in the operation manual and maintenance materials.

3. Contact SMC beforehand and take special consideration of safety measures if the product is to be used in any of the following conditions.

1. Use of the product under conditions and environments outside of the specifications described in the catalog or operation manual.
2. Installation on equipment in conjunction with atomic energy, railways, air navigation, space, shipping, vehicles, military, medical treatment, combustion and recreation, or equipment in contact with food and beverages, emergency stop circuits, clutch and brake circuits in press applications, safety equipment or other applications unsuitable for the standard specifications described in the product catalog.
3. An application which could have negative effects on people, property, or animals requiring special safety analysis.

Caution

1. The product is provided for use in manufacturing industries.

The product herein described is basically provided for peaceful use in manufacturing industries.

If considering using the product in other industries, consult SMC beforehand and exchange specifications or a contract if necessary.
If anything is unclear, contact your nearest sales branch.

Compliance Requirements

1. The use of SMC products with production equipment for the manufacture of weapons of mass destruction (WMD) or any other weapon is strictly prohibited.
2. The exports of SMC products or technology from one country to another are governed by the relevant security laws and regulations of the countries involved in the transaction. Prior to the shipment of a SMC product to another country, assure that all local rules governing that export are known and followed.

Caution

SMC products are not intended for use as instruments for legal metrology. Measurement instruments that SMC manufactures or sells have not been qualified by type approval tests relevant to the metrology (measurement) laws of each country. Therefore, SMC products cannot be used for business or certification ordained by the metrology (measurement) laws of each country.

Limited warranty and Disclaimer/ Compliance Requirements

The product used is subject to the following “Limited warranty and Disclaimer” and “Compliance Requirements”.

Read and accept them before using the product.

Limited warranty and Disclaimer

1. Period

The warranty period of the product is 1 year in service or 1.5 years after the product is delivered, whichever is first.

2. Scope

For any failure reported within the warranty period which is clearly our responsibility, replacement parts will be provided. In that case, removed parts shall become the property of SMC.
This guarantee applies only to our product independently, and not to any other damage incurred due to the failure of the product.

3. Content

The following situations are out of scope of this warranty.

1. The product was incorrectly installed or connected with other equipment.
2. The product was modified or altered in construction.
3. The failure was a secondary failure of the product caused by the failure of equipment connected to the product.
4. The failure was caused by a natural disaster such as an earthquake, typhoon, or flood, or by an accident or fire.
5. The failure was caused by operation different from that shown in the Operation Manual or outside of the specifications.
6. The checks and maintenance specified (daily checks and regular checks) were not performed.
7. The failure was caused by the use of circulating fluid or facility water other than those specified.
8. The failure occurred naturally over time (such as discoloration of a painted or plated face).
9. The failure does not affect the functioning of the product (such as new sounds, noises and vibrations).
10. The failure was due to the “Installation Environment” specified in the Operation Manual.

4. Disclaimer

1. Expenses for daily and regular checks
2. Expenses for repairs performed by other companies
3. Expenses for transfer, installation and removal of the product
4. Expenses for replacement of parts other than those in this product, or for the supply of liquids
5. Inconvenience and loss due to product failure (such as telephone bills, compensation for workplace closure, and commercial losses)

For warranted repair, please contact the supplier you purchased this product from.

Revision History

Edition B * Single-phase 100 VAC (50/60 Hz) and 110 VAC (60 Hz) power supplies have been added.
* The circulating fluid temperature, flow rate, and electric conductivity setting/display range have been expanded.
* Number of pages has been increased from 32 to 36. XY

Edition C * The HRR010 (air-cooled type, water-cooled type) has been added.
* Number of pages has been increased from 36 to 44. YV

Edition D * The HRR050 (air-cooled type, water-cooled type) has been added.
* A caster adjuster-foot kit has been added as an optional accessory.
* Number of pages has been increased from 44 to 48. YX

Safety Instructions

Be sure to read the “Handling Precautions for SMC Products” (M-E03-3) and “Operation Manual” before use.