

Datasheet

Radar-based sensors for detecting moving and stationary targets

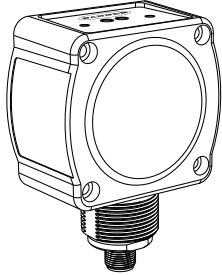

- FMCW radar detects moving and stationary objects
- Adjustable sensing field—ignores objects beyond setpoint
- Easy setup and configuration of range, sensitivity, and output with simple DIP switches
- Sensing functions are unaffected by wind, falling rain or snow, fog, humidity, air temperatures, or light
- Sensor operates in Industrial, Scientific, and Medical (ISM) telecommunication band
- Rugged IP67 housing withstands harsh environments



WARNING:

- **Do not use this device for personnel protection**
- Using this device for personnel protection could result in serious injury or death.
- This device does not include the self-checking redundant circuitry necessary to allow its use in personnel safety applications. A device failure or malfunction can cause either an energized (on) or de-energized (off) output condition.

Models

Model ¹	Maximum Range	Connection	Supply Voltage	Telecom Approval ²	Output
QT50R-US-AFH-FL	24 m (78 ft)	5-wire 2 m (6.5 ft) integral cable	12 to 30 V DC	Telecom approved for US and Canada	Bipolar NPN/PNP DIP-switch-selectable N.O. or N.C
QT50R-EU-AFH-FL				Telecom approved for Europe, UK, Australia, New Zealand, China, and Japan	

Overview

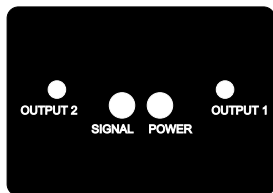

- Output 1 and 2 LEDs: Yellow (output energized); Red (configuration)
 - Power LED: Green (power ON)
 - Signal LED: Red (flashes in proportion to the signal strength)
- Access the DIP switches behind the threaded cap on the sensor back (not shown)

The R-GAGE sensor emits a well-defined beam of high-frequency radio waves from an internal antenna. Some of this emitted energy reflects back to the receiving antenna. Signal processing electronics in the sensor determine the distance from the sensor to the object based on the time delay of the return signal. The sensor can be configured (via DIP switches) to sense objects up to a specific distance, ignoring objects beyond this distance (also called background suppression).

R-GAGE setpoint distances, minimum and maximum (sensor will detect objects up to setpoint and ignore objects beyond the setpoint).

¹

- Integral 2 m (6.5 ft) unterminated cable models are listed.
- To order the 5-pin M12 integral quick disconnect model, add the suffix "Q" to the model number. However, the Q is added before the last hyphen. For example, **QT50R-xx-AFHQ-FL**.
- Models with a quick disconnect require a mating cordset. See [Quick Disconnect \(QD\) Cordsets](#) on page 5.

² For additional countries, contact Banner Engineering.



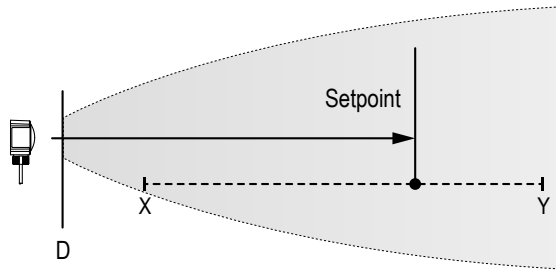

		EU Models	US Models
X	Minimum setpoint distance	2 m (6.6 ft)	3.5 m (11.5 ft)
Y	Maximum setpoint distance	24 m (78.7 ft)	24 m (78.7 ft)
D	Dead Zone ³		

Wiring

There is no connection to the gray (gy) wire.

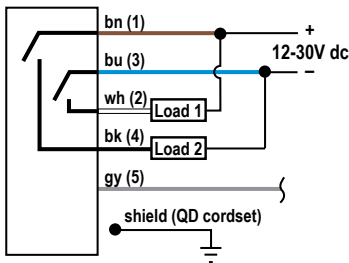

Note: Banner recommends that the shield wire (quick-disconnect cordsets only) be connected to earth ground or dc common. Shielded cordsets are recommended for all quick-disconnect models.

Figure 1. M12 Male Pinout

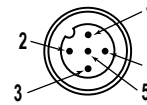

Sensor Configuration

Configure the sensor using the DIP switches. Use the included spanner to open the screw-off cover and access the DIP switches.



Important: Tighten the DIP switch cover a full quarter turn after contact to maintain the watertight seal.

DIP Switch Functions

Switch	Function
1, 2, 3	Sensing distance (detects objects from sensor face to this point)
4, 5	Sensitivity (higher sensitivity sees weaker objects and has a larger beam pattern)
6	Normally open/normally closed output functionality
7, 8	Response Speed

DIP switch 1 is on the left and DIP switch 8 is on the right.

Distance Settings

Switch 1	Switch 2	Switch 3	Distance	
			EU Models	US Models
0	0	0	2 m (6.6 ft)	3.5 m (11.5 ft)
0	0	1	3 m (9.8 ft)	4 m (13.1 ft)
0	1	0	4 m (13.1 ft)	5 m (16.4 ft)
0	1	1	6 m (19.7 ft)	6 m (19.7 ft)
1*	0*	0*	8 m (26.2 ft)	8 m (26.2 ft)
1	0	1	12 m (39.4 ft)	12 m (39.4 ft)
1	1	0	16 m (52.5 ft)	16 m (52.5 ft)
1	1	1	24 m (78.7 ft)	24 m (78.7 ft)

* Default settings

³ Typical dead zone: 0.4 m (1.3 ft) for moving and 1.0 m (3.3 ft) for stationary targets, but varies with target reflectivity



Note: Highest sensitivity is achieved only if sensing distance is 8 m (26.2 ft) or less.



Note: Near-field sensitivity boost is enabled when set to 4 m (13.1 ft) or less.

Sensitivity Selection

Switch 4	Switch 5	Sensitivity
0*	0*	4 (Highest)
0	1	3 (High)
1	0	2 (Medium)
1	1	1 (Low)

* Default settings



Note: Use the sensitivity selection to ignore unwanted weak reflections within the field of view, and not to narrow the beam width. Narrow-beam R-GAGE sensor models are available.

Output Configuration

Switch 6	Normally Open/Normally Closed
0*	Normally open
1	Normally closed

* Default settings

Response Time

Switch 7	Switch 8	On Total (ms)	Off Total (ms)	Total (ms)
0	0	1000	1000	2000
0*	1*	2000	1000	3000
1	0	1000	2000	3000
1	1	2000	6000	8000

* Default settings

Specifications

Supply Voltage

12 V DC to 30 V DC, less than 100 mA, exclusive of load

Range

The sensor is able to detect a proper object (see Detectable Objects) from 1 m to 24 m (3.3 ft to 78.7 ft), depending on target

Detectable Objects

Objects containing metal, water, or similar high-dielectric materials

Operating Principle

Frequency modulated continuous-wave (FMCW) radar

Operating Frequency

US Models: 24.075–24.175 GHz, ISM Band
EU Models: 24.050–24.250 GHz, ISM Band

Maximum Output Power

ERP: 3.3 mW, 5 dBm
EIRP: 100 mW, 20 dBm

Supply Protection Circuitry

Protected against reverse polarity and transient overvoltages

Indicators

Power LED: Green (power ON)

Signal Strength LED: Red, flashes in proportion to signal strength. Steady on at 4x excess gain. Only indicates signal amplitude, not target distance.

Output LEDs: Yellow (output energized) / Red (configuration)

Adjustments

DIP-switch-configurable sensing distance, sensitivity, response time, and output configuration

Construction

Housing: ABS/polycarbonate

Lightpipes: Acrylic

Access Cap: Polyester

Output Protection

Protected against short circuit conditions

Operating Temperature

–40 °C to +65 °C (–40 °F to +149 °F)

Environmental Rating

IP67

Delay at Power-up

Less than 2 seconds

Output Configuration

Bipolar NPN/PNP output, 150mA; DIP switch 6 selects N.O. (default) or N.C. operation

Response Time

DIP switches 7 & 8 select ON/OFF response time

Connections

Integral 5-wire 2 m (6.5 ft) cable or M12 quick disconnect fitting. Quick disconnect models require a mating cordset

Certifications

ETS/EN 300 440
 FCC part 15
 RSS-210
 CMIIT Category G
 ARIB STD T-73
 for others, contact Banner Engineering
 Country of Origin: USA

FCC ID:UE3QT50RUS— This equipment has been tested and found to comply with the limits for a Class A digital device, pursuant to part 15 of the FCC Rules. These limits are designed to provide reasonable protection against harmful interference when the equipment is operated in a commercial environment. This equipment generates, uses, and can radiate radio frequency energy and, if not installed and used in accordance with the instruction manual, may cause harmful interference to radio communications. Operation of this equipment in a residential area is likely to cause harmful interference in which case the user will be required to correct the interference at his own expense.

IC: 7044A-QT50RCA—This device contains licence-exempt transmitter(s)/receiver(s) that comply with Innovation, Science and Economic Development Canada’s licence-exempt RSS(s). Operation is subject to the following two conditions:

1. This device may not cause interference.
2. This device must accept any interference, including interference that may cause undesired operation of the device.

Cet appareil contient des émetteurs/récepteurs exemptés de licence conformes à la norme Innovation, Sciences, et Développement économique Canada. L’exploitation est autorisée aux deux conditions suivantes:

1. L’appareil ne doit pas produire de brouillage.
2. L’utilisateur de l’appareil doit accepter tout brouillage radioélectrique subi, même si le brouillage est susceptible d’en compromettre le fonctionnement.

Beam Pattern

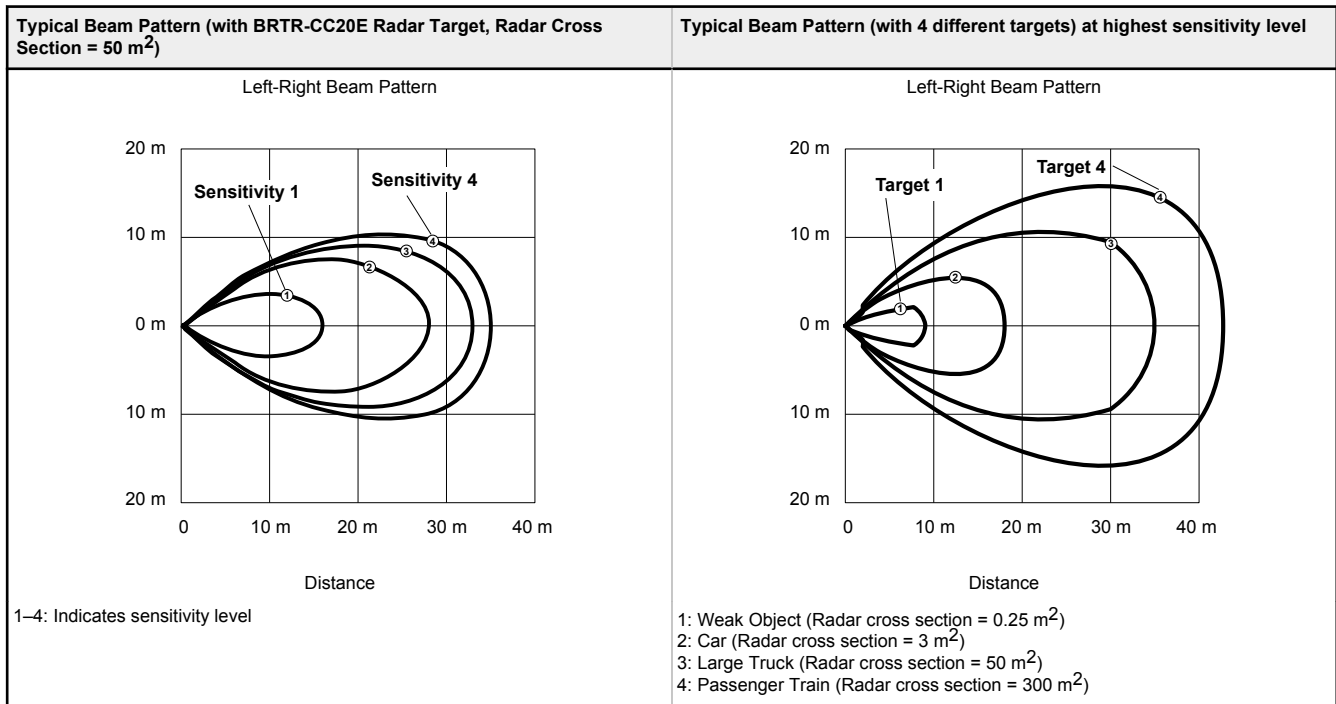

Note: The effective beam pattern depends on the sensitivity level and target properties.

Dimensions

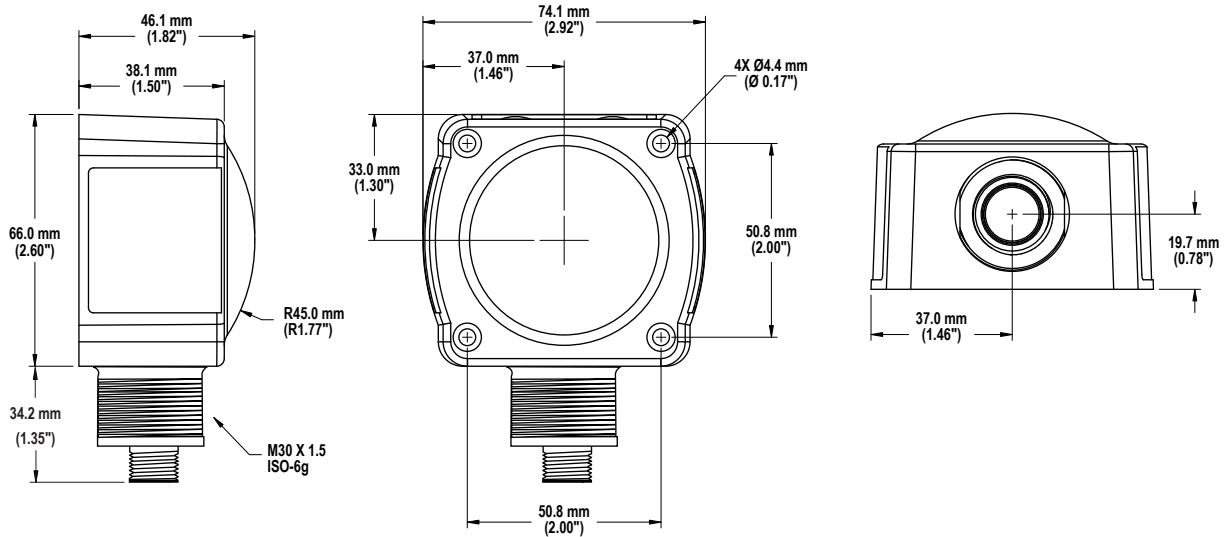

Accessories

Quick Disconnect (QD) Cordsets

5-Pin Threaded M12 Cordsets with Shield—Single Ended				
Model	Length	Style	Dimensions	Pinout (Female)
MQDEC2-506	2 m (6.56 ft)	Straight		<p>1 = Brown 2 = White 3 = Blue 4 = Black 5 = Gray</p>
MQDEC2-515	5 m (16.4 ft)			
MQDEC2-530	9 m (29.5 ft)			
MQDEC2-550	15 m (49.2 ft)	Right-Angle		
MQDEC2-506RA	2 m (6.56 ft)			
MQDEC2-515RA	5 m (16.4 ft)			
MQDEC2-530RA	9 m (29.5 ft)			
MQDEC2-550RA	15 m (49.2 ft)			



Note: Pin 5 is not used.

Mounting Brackets

All measurements are listed in millimeters, unless noted otherwise.

SMB30SC

- Swivel bracket with 30 mm mounting hole for sensor
- Black reinforced thermoplastic polyester
- Stainless steel mounting and swivel locking hardware included

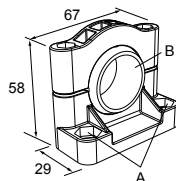

Hole center spacing: A=ø 50.8

Hole size: A=ø 7.0, B=ø 30.0

SMB30MM

- 12-ga. stainless steel bracket with curved mounting slots for versatile orientation
- Clearance for M6 (¼ in) hardware
- Mounting hole for 30 mm sensor

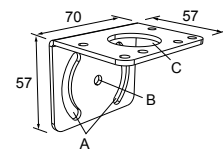

Hole center spacing: A = 51, A to B = 25.4

Hole size: A = 42.6 x 7, B = ø 6.4, C = ø 30.1

Weather Deflectors and Shields

QT50RCK Weather Deflector

- Required if the R-GAGE is exposed to rain or snow
- Prevents buildup of water or ice from interfering with sensor performance

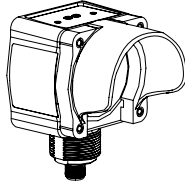

QT50RWS Weather Shield

- Coated to help repel water and maximize signal strength
- Hardware included for easy installation and replacement

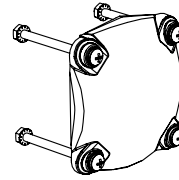

Banner Engineering Corp. Limited Warranty

Banner Engineering Corp. warrants its products to be free from defects in material and workmanship for one year following the date of shipment. Banner Engineering Corp. will repair or replace, free of charge, any product of its manufacture which, at the time it is returned to the factory, is found to have been defective during the warranty period. This warranty does not cover damage or liability for misuse, abuse, or the improper application or installation of the Banner product.

THIS LIMITED WARRANTY IS EXCLUSIVE AND IN LIEU OF ALL OTHER WARRANTIES WHETHER EXPRESS OR IMPLIED (INCLUDING, WITHOUT LIMITATION, ANY WARRANTY OF MERCHANTABILITY OR FITNESS FOR A PARTICULAR PURPOSE), AND WHETHER ARISING UNDER COURSE OF PERFORMANCE, COURSE OF DEALING OR TRADE USAGE.

This Warranty is exclusive and limited to repair or, at the discretion of Banner Engineering Corp., replacement. **IN NO EVENT SHALL BANNER ENGINEERING CORP. BE LIABLE TO BUYER OR ANY OTHER PERSON OR ENTITY FOR ANY EXTRA COSTS, EXPENSES, LOSSES, LOSS OF PROFITS, OR ANY INCIDENTAL, CONSEQUENTIAL OR SPECIAL DAMAGES RESULTING FROM ANY PRODUCT DEFECT OR FROM THE USE OR INABILITY TO USE THE PRODUCT, WHETHER ARISING IN CONTRACT OR WARRANTY, STATUTE, TORT, STRICT LIABILITY, NEGLIGENCE, OR OTHERWISE.**

Banner Engineering Corp. reserves the right to change, modify or improve the design of the product without assuming any obligations or liabilities relating to any product previously manufactured by Banner Engineering Corp. Any misuse, abuse, or improper application or installation of this product or use of the product for personal protection applications when the product is identified as not intended for such purposes will void the product warranty. Any modifications to this product without prior express approval by Banner Engineering Corp will void the product warranties. All specifications published in this document are subject to change; Banner reserves the right to modify product specifications or update documentation at any time. Specifications and product information in English supersede that which is provided in any other language. For the most recent version of any documentation, refer to:

www.bannerengineering.com.

For patent information, see www.bannerengineering.com/patents.



more sensors, more solutions