



Multifunction Meters

Transducers & Isolators

Temperature Controllers

Converters & Recorders

Digital Panel Meters

Current Transformers

Analogue Panel Meters

Shunts

Digital Multimeters

Clamp Meters

Insulation Testers

TRUE RMS DIGITAL PROTECTION RELAY RELAY V/HZ

User Manual - Issue 1.0

Features

- True RMS Measurement
- 7 different parameters on site selection
- Dual color LED for fault indication
- Trip relay DPM with Class 0.5
- Stores last 15 faults
- Detection of fault with display of parameter value
- 4 digit 7 segment LED display
- Configuration via USB-based PRKAB

1. Applications

- Over voltage
- Under voltage
- Start up standby generators
- Operation of mains failure units
- Switching standby hybrid supplies
- Protecting computer supplies
- Close control of equipment
- Gensets - to monitor correct operation of the AVR (Automatic voltage regulator) and excitation system
- Motors-Some electric motors are voltage sensitive, and can overheat and burn out when operated at low voltage
- UPS supplies - When the main A. C. supply falls outside the acceptable operating voltage window the relay can initiate a change over to an alternate or standby supply
- Motors - Single Phasing
- Incorrect sequence connection.

2. Product Features

- Over voltage
 - Under voltage
 - Single phasing
 - Phase unbalance
 - Phase incorrect sequence
 - Over frequency
 - Under frequency
 - 4 Digits ultra bright 7 Segment LED Display
 - Trip Relay DPM with Class 0.5
 - True RMS measurement
The instrument measures distorted waveform up to 15th harmonic
 - Previous fault Storage
Instrument memorizes the last 15 fault occurred
 - LED Indication
 - LED indication for relay-1 and relay-2 status
 - Trip indication are displayed on 4 Digit display
 - Dual color LED for per phase indication green color for normal condition and Red color for faulty condition
 - User selectable 3 phase 3W or 4W
User can on site program the network connection as either 1P2W / 3P4W / 3P3W network using front panel keys
 - Adjustable set point for
 - Phase Unbalance
 - Over voltage
 - Under voltage
 - Phase failure
 - Over frequency
 - Under frequency
 - Adjustable time delay for
 - Phase Unbalance
 - Over voltage
 - Under voltage
 - Over frequency
 - Under frequency
- AND function
- User can use ANDing function to set trip on any two fault condition
- Configuration via USB-based PRKAB
User can configure the Meter using USB-based PRKAB
 - Trip or Buzzer mode
Relay can be used to protect the system or simply to control the buzzer. Trip mode is for protection purpose and Buzz mode is for buzzer control
 - Auto / Manual reset
In auto mode instrument automatically clears itself. If the device set into manual mode, the device must be manually reset by push button through display if it goes into fault
 - User selectable PT primary
The Primary of Potential transformer can be programmed on site from 100 VL-L to 1200 kVL-L for Voltage trip relay
 - User selectable PT Secondary
The input rated voltage can be programmed on site as 100 - 600VL-L using front panel keys
 - Onsite selection of Auto scroll / Fixed Screen
User can set the display in auto scrolling mode or fixed screen mode using front panel keys
 - Compliance to International Safety standards
Compliance to International Safety standard IEC 61010-1- 2010
 - EMC Compatibility
Compliance to International standard IEC 61326 - 1

3. Dimensions

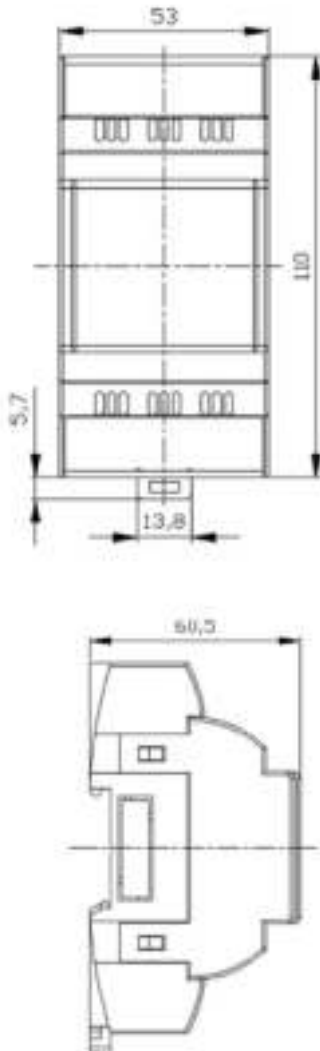

4. Technical Specifications

Input Voltage	
Nominal Input Voltage (AC RMS)	600VL-L (346.42VL-N)
Max Continuous Input Voltage	127% of PT Secondary
System PT Secondary Values	100VL-L to 600 VL-L programmable on site
System PT Primary Values	100VL-L to 1200 kVL-L programmable on site
Nominal Frequency	50 / 60 Hz (programmable on site)
Input Voltage Burden	< 0.6VA approx.
Auxiliary Supply	
External Higher Aux	60 V – 300 V AC/DC
Higher Aux Nominal value	230 V AC/DC 50/60 Hz for AC Aux
	OR
External Lower Aux	20 V – 60 VDC / 20 V – 40 VAC
Lower Aux Nominal value	48 VDC / 24 VAC 50/60 Hz for AC Aux
Aux Supply Frequency	45 to 66 Hz range
Aux Supply Burden	< 4VA approx.
Overload Withstand	
Voltage	2 x rated value for 1 second, repeated 10 times at 10 seconds
Operating Measuring Ranges	
Voltage	Range 20...125% of PT Secondary
Frequency	40...70Hz
Reference condition for Accuracy	
Reference Condition	23°C +/- 2°C
Input waveform	Sinusoidal (distortion factor 0.005)
Input Frequency	50 or 60 Hz ±2%
Auxiliary supply voltage	Nominal Value ±1%
Auxiliary supply frequency	Nominal Value ±1%

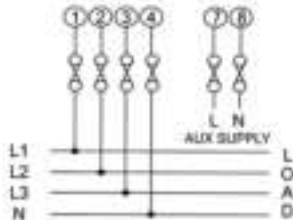
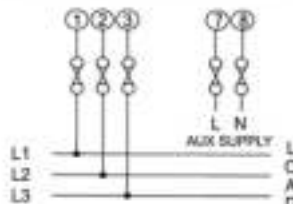
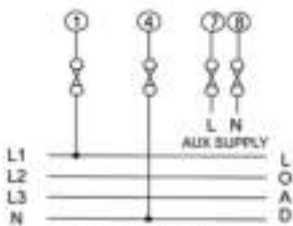
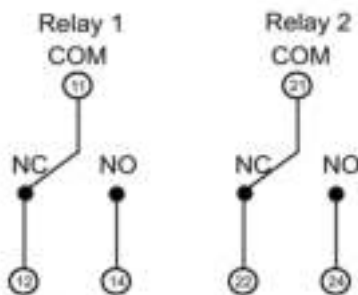
5. Electrical Connection

3 Phase 4 wire Unbalanced load

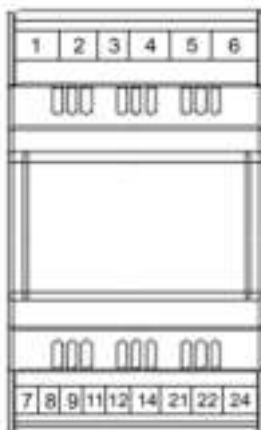
3 Phase 3 wire Unbalanced load

1 Phase 2 Wire

Note- Relay Contacts are shown in power off condition

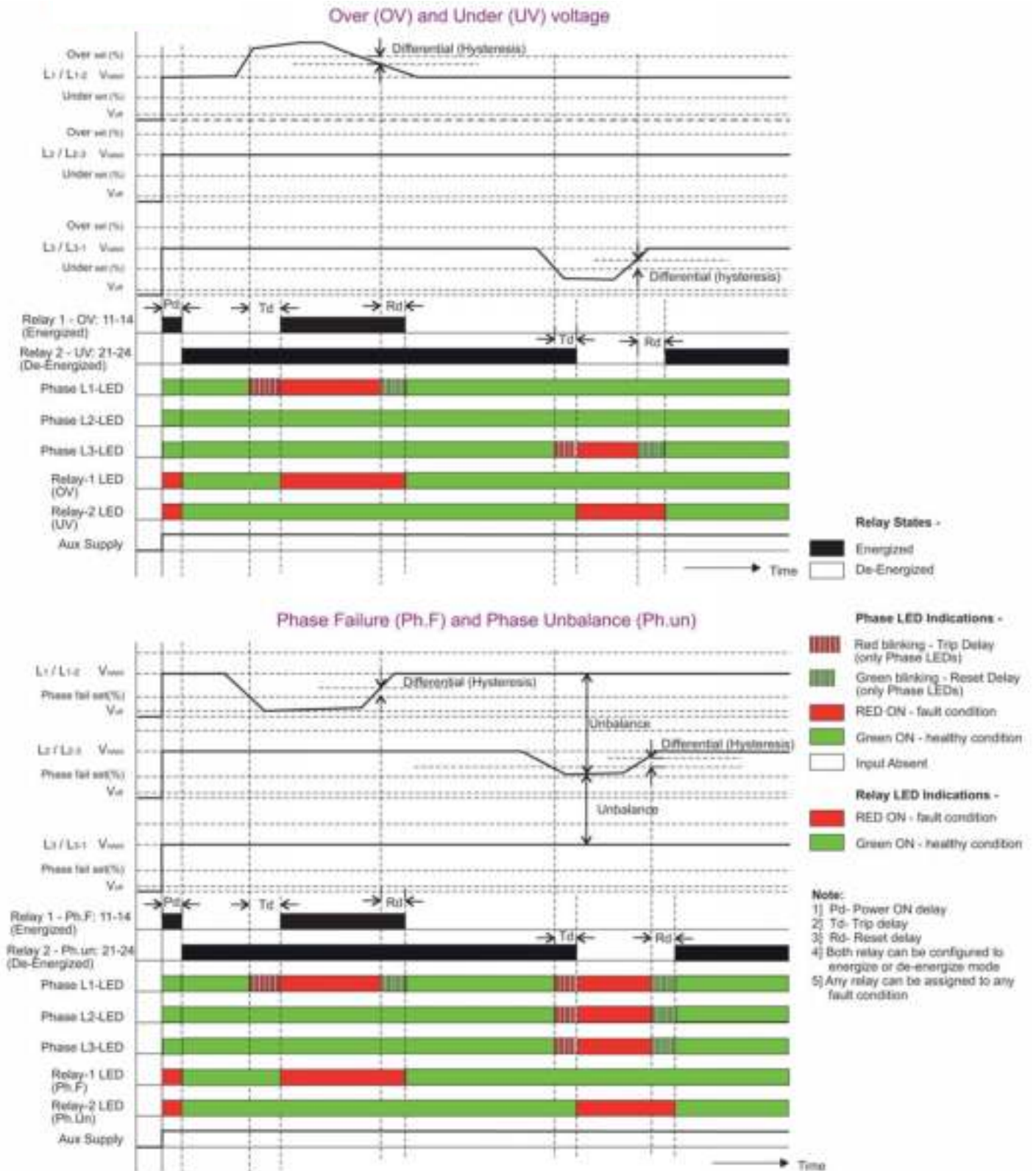

Accuracy:	
Voltage	±0.5% of nominal value
Frequency	±0.2 Hz
Power ON, Trip, Reset Delays	±140 msec or ±5% of Set Delay, Whichever is Greater (WIG)
Influence of Variations	
Temperature coefficient :	0.025%/°C for Voltage
Applicable Standards	
EMC	IEC 61326 - 1
Immunity Low level	IEC 61000-4-3. 10V/m min – Level 3 industrial
Safety	IEC 61010-1-2010 , Permanently connected use
IP for water & dust	IEC60529
Pollution degree:	2
Installation category:	300V CAT III / 600V CAT II
High Voltage Test	2.2 kV AC, 50Hz for 1 minute between all Electrical circuits
Environmental	
Operating temperature	-10 to +55°C
Storage temperature	-25 to +70°C
Relative humidity	0... 90% non condensing
Shock	15g in 3 planes
Vibration	10... 55 Hz, 0.15mm amplitude
Enclosure	IP20 (front face only)
Relay Contacts	
Types of output	1CO, 2CO, 1CO+1CO
Contact Ratings (Res. Load)	5A/250VAC/30VDC
Mechanical Endurance	1x10 ⁷ OPS
Electrical Endurance	NO- 3x10 ⁴ OPS
NC- 1x10 ⁴ OPS 1x10 ⁵ OPS for 2CO relay	for 1CO / 1CO+1CO relay
Mechanical Attributes	
Weight	300g Approx.

6.Characteristics



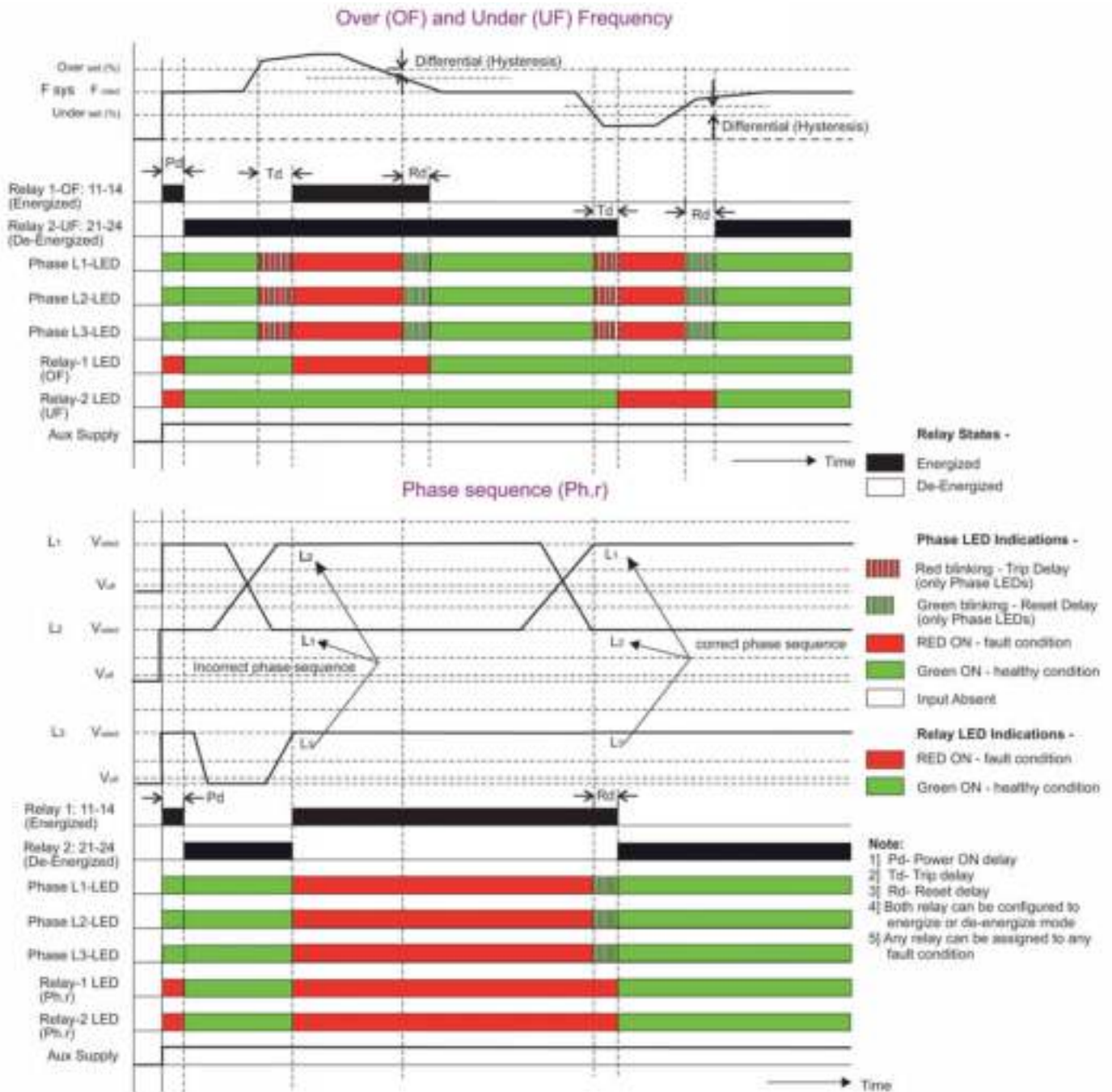

7. ANSI Numbers:

ANSI NO.	Acronyms
27	Under Voltage Relay
47	Phase-Sequence or Phase-Unbalance Voltage Relay
59	Over Voltage Relay
81	Over / Under Frequency Relay

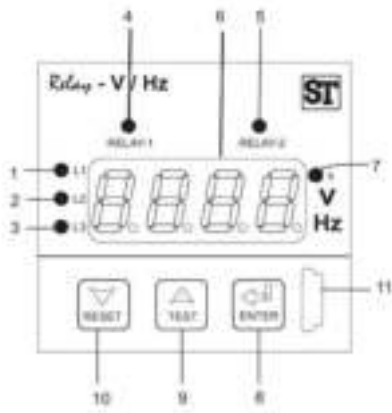

8. Operating Elements

- 1 L1- LED : Indicates status of V1 (in 3P4W) and V1-2 in 3P3W. It Lights green when input voltage is healthy, red in fault condition, red blinking in trip delay and green blinking in reset delay
- 2 L2-LED : Indicates status of V2 (in 3P4W) and V2-3 in 3P3W. It Lights green when input voltage is healthy, red in fault condition, red blinking in trip delay and green blinking in reset delay
- 3 L3- LED : Indicates status of V3 (in 3P4W) and V3-1 in 3P3W. It Lights green when input voltage is healthy, red in fault condition, red blinking in trip delay and green blinking in reset delay
- 4/5 Relay-1 and Relay-2 status LED : Indicates status of relay-1and relay-2 respectively. It lights green for relay in healthy condition and red for relay in trip condition
- 6 4 Digit ultra bright 7 seg LED Display
- 7 K LED : It is used to show value in KV
- 8 Enter Key : Confirms changes of parameter setting. When on the measurement screen, holding for 3 sec enters in setup menu
- 9 Test Key : Increments setting value, move upwards in the menu or change parameter. It is also used to test operation of relay. Continuous holding of test key changes relay position and when released, it resets the relay position (Only in healthy condition)
- 10 Reset Key : Decrements setting value, move downwards in the menu or change parameter. It is also used to reset relay when manual reset mode is selected
- 11 Configuration via USB-based PRKAB.

9. Parameter Settings

Parameters	Relay-V/Hz
Trip setting for phase failure	20 - 85%
Trip setting for Voltage Unbalance	2 - 20%
Trip setting for over voltage	101 - 125%
Trip setting for under voltage	70 - 99%
Trip setting for Max Frequency	101 - 110%
Trip setting for Min Frequency	90 - 99%
Setting for Differential / hysteresis	1 - 15%*
Nominal Frequency settable	50 / 60 Hz
Individual Faults can be deactivated as per system requirement	Yes (Phase failure can not be deactivated)
Reset option	Auto / Manual
Relay control mode	De-energize/energize
Reset Delay	0.2 - 30s
Programmable trip Delay for over voltage, Under Voltage, Frequency, Under Frequency, Phase failure, Phase Unbalance	Over 0 - 30s
PT primary Voltage(V L-L)	100 - 1200KV L-L
Power ON Delay	0.5 - 30s

Note: Regenerate voltage may get produced in open phase due to blown fuse for some loads. In such a case, set the trip point for Phase Failure (20 - 85%) as per requirement considering the possibility of a higher regenerated voltage. *Differential setting range for voltage unbalance is limited as per its setting of trip point.

10. Hysteresis Calculation Method:

Example: -

For "OV" (Over Voltage)
PT Secondary = 100 VL-L.
Trip point = 105% of PT Secondary = 105 VL-L
Hysteresis = 2% of PT Secondary = 2 VL-L
Relay Reset point = Trip point - Hysteresis
= 105 - 2
= 103 VL-L.

Example: -

For "Ph.un" (Phase Unbalance)
PT Secondary = 100 VL-L.
Trip point = 10% of PT Secondary = 10 VL-L
Hysteresis = 2% of PT Secondary = 2 VL-L.
Relay Reset point = Trip point - Hysteresis
= 10 - 2
= 8 VL-L.



Omicron V/Hz

Code	Description
OR10-V38EH01000000	PROG. 3PH V 100-600VLL 60-300U 1CO
OR10-V38EH02000000	PROG. 3PH V 100-600VLL 60-300U 2CO
OR10-V38EH11000000	PROG. 3PH V 100-600VLL 60-300U 1CO+1CO
OR10-V58EH01000000	3PH VOLTAGE MON. 100-600VLL 60-300U 1CO
OR10-V58EH02000000	3PH VOLTAGE MON. 100-600VLL 60-300U 2CO
OR10-V58EH11000000	3PH VOLT MON. 100-600VLL 60-300U 1CO+1CO

