

Q90R R-GAGE® Radar Sensor Instruction Manual



Original Instructions
p/n: 237883 Rev. A
March 05, 2024

© Banner Engineering Corp. All rights reserved.

Contents

Chapter 1 Product Description

1.1 Models	4
1.2 Overview.....	4
1.3 Features and Indicators.....	5
1.4 Radar Configuration Software	5

Chapter 2 Installation Instructions

2.1 Sensor Orientation.....	6
2.2 Wiring	6
2.3 Mount the Device.....	7

Chapter 3 Getting Started

3.1 Install the Software.....	8
3.2 Connect to the Sensor.....	8
3.3 Software Overview	9

Chapter 4 Banner Radar Configuration Workspace

4.1 Navigation Toolbar	10
4.2 Live Sensor Data and Legend	10
4.3 Summary Pane.....	11
4.4 Sensor Settings Pane.....	11
4.4.1 General Tab	11
4.4.2 Analog Tab	12
4.4.3 Discrete 1 Tab	13
4.4.4 Discrete 2 Tab	13
4.5 Live Sensor Data Controls.....	14
4.6 Using Measurement Hold Example	15

Chapter 5 Configuring a Sensor

5.1 Banner Radar Configuration Software.....	16
5.2 IO-Link Interface	16
5.3 Remote Input	16
5.4 Remote Teach.....	19
5.5 Remote Setup.....	19
5.5.1 Analog Teach Modes.....	20
5.5.2 Discrete Teach Modes	20
5.5.3 Set the Sensitivity	20
5.5.4 Set the Speed	20
5.5.5 Target Selection Mode	21
5.6 Reset the Sensor to Factory Defaults.....	21
5.7 Factory Default Settings	22

Chapter 6 Specifications

6.1 FCC Part 15 Class A for Intentional Radiators	24
6.2 Industry Canada Statement for Intentional Radiators.....	25
6.3 Dimensions.....	25
6.4 Beam Patterns.....	25

Chapter 7 Accessories

7.1 Configuration Tool.....	27
7.2 Cordsets	27
7.3 Brackets.....	28
7.4 IO-Link Masters	29

Chapter 8 Product Support

8.1 Update the Software	30
8.2 Repairs	30
8.3 Contact Us.....	31
8.4 Banner Engineering Corp. Software Copyright Notice	31
8.5 Banner Engineering Corp Limited Warranty.....	31

Index 32

Chapter Contents

1.1 Models 4
 1.2 Overview 4
 1.3 Features and Indicators..... 5
 1.4 Radar Configuration Software 5

Chapter 1 Product Description

Radar-Based Sensors for Detection and Measurement of Moving and Stationary Targets. Patent pending.

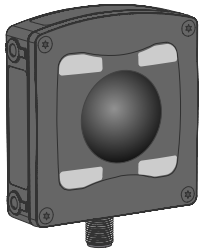

- FMCW radar detects moving and stationary objects
- Adjustable sensing field—ignores objects beyond setpoint
- Easy setup and configuration of range, sensitivity, and output using the Banner Radar Configuration Software
- Sensing functions are immune to wind, fog, steam, and temperature changes and resistant to rain and snow
- Compact, rugged IP69K housing withstands harsh environments

WARNING:



- **Do not use this device for personnel protection**
- Using this device for personnel protection could result in serious injury or death.
- This device does not include the self-checking redundant circuitry necessary to allow its use in personnel safety applications. A device failure or malfunction can cause either an energized (on) or de-energized (off) output condition.

IMPORTANT: To satisfy RF exposure requirements, this device and its antenna must operate with a separation distance of at least 20 cm from all persons.

1.1 Models

Table 1. Q90R-4040 Models

Models	Detection Range	Supply Voltage	Telecom Approved	Output
Q90R-4040-6KIQ	0.15 m to 20 m (0.5 ft to 65.6 ft)	10 V DC to 30 V DC	US, Canada, Europe, Australia, New Zealand	Analog current (4 mA to 20 mA, 1 NPN/PNP discrete, and IO-Link)
Q90R-4040-6KUQ		12 V DC to 30 V DC		Analog voltage (0 V to 10 V or 0.5 V to 4.5 V, 1 NPN/ PNP discrete, and IO-Link)
Q90R-4040-6KDQ		10 V DC to 30 V DC		Dual discrete (NPN/PNP, PFM, and IO-Link)

1.2 Overview

The Q90R is an industrial radar sensor that uses high-frequency radio waves from its internal antenna to detect and measure distance to objects in its field of view.

The Q90R detects a wide variety of materials including metal, liquids, or organic materials. Use the supplied software, IO-Link, or a remote input wire to configure the sensor to sense objects within a specified distance while ignoring objects beyond

this distance (background suppression). Or configure the sensor to indicate the presence or absence of objects at a specific (or "taught") distance or range of distances (retroreflective).

Figure 1. Sensing Range

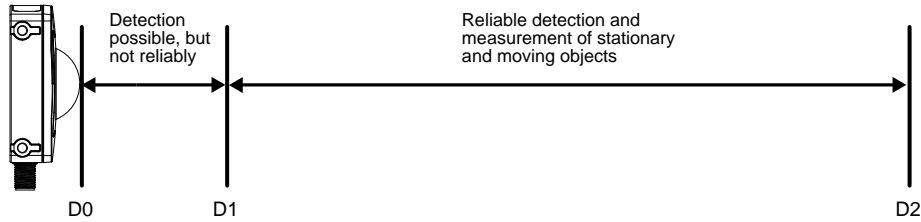

D0 (m)	D1 (m)	D2 (m)
0	0.15	20

1.3 Features and Indicators

	LED	Color	Description	
	1	Power	Green	Power ON
	2	Signal Strength	Green	Signal strength indication
	3	Output 1	Amber	Target is within the taught analog span or discrete output status
	4	Output 2	Amber	Discrete output status

1.4 Radar Configuration Software

Use Banner's Radar Configuration Software to:

- Set up the sensor in 3 easy steps: set the switch point distance, signal strength threshold, and response time
- Easily monitor device status via the software
- Visualize the application in real-time
- Make adjustments to sensor settings on the fly

For more information, visit www.bannerengineering.com/us/en/products/sensors/software/radar-configuration.html.

Chapter Contents

2.1 Sensor Orientation 6
 2.2 Wiring 6
 2.3 Mount the Device 7

Chapter 2 Installation Instructions

2.1 Sensor Orientation

Correct sensor-to-object orientation is important to ensure proper sensing.

Minimize the tilt angle of a target relative to the sensor. The target should be tilted less than half of the beam angle.

Figure 2. Tilt angle of the target relative to the sensor

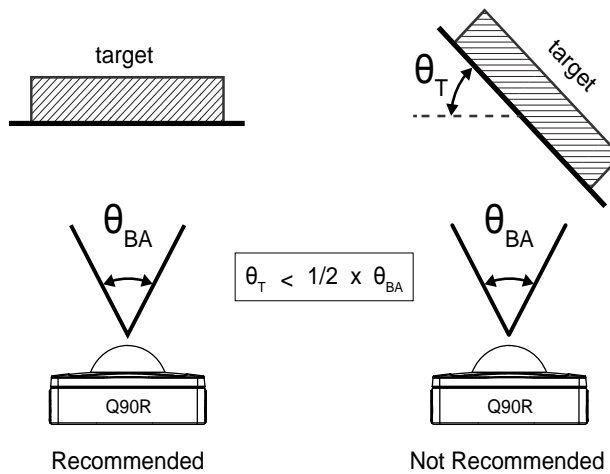

T= Target Angle, BA=Beam Angle

2.2 Wiring

Quick disconnect wiring diagrams are functionally identical.

Figure 3. Push-pull Output and Analog Current Output

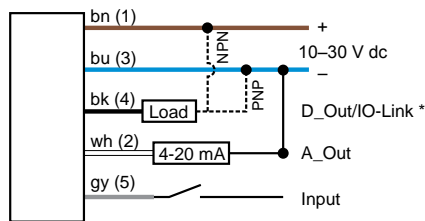

* Push-Pull output. User-configurable PNP/NPN setting.

Figure 4. Push-pull Output and Analog Voltage Output

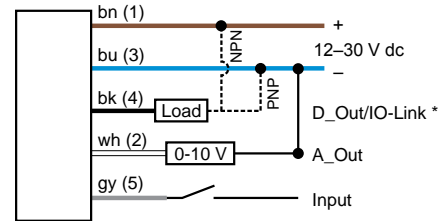

* Push-Pull output. User-configurable PNP/NPN setting.

Continued on page 7

Continued from page 6

Figure 5. Dual Discrete Output

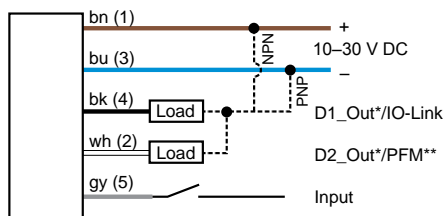

* Push-Pull output. User-configurable PNP/NPN setting.

** Pulse Frequency Modulation

Key:

- 1 = Brown
- 2 = White
- 3 = Blue
- 4 = Black
- 5 = Gray (Connect for use with remote input or Banner Radar Configuration software)

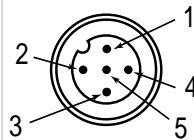

NOTE: Banner recommends that the shield wire (quick-disconnect cordsets only) be connected to earth ground or dc common. Shielded cordsets are recommended for all quick-disconnect models.

2.3 Mount the Device

1. If a bracket is needed, mount the device onto the bracket.
2. Mount the device (or the device and the bracket) to the machine or equipment at the desired location. Do not tighten the mounting screws at this time.
3. Check the device alignment.
4. Tighten the mounting screws to secure the device (or the device and the bracket) in the aligned position.

Chapter Contents

3.1 Install the Software 8
 3.2 Connect to the Sensor 8
 3.3 Software Overview 9

Chapter 3 Getting Started

Power up the sensor, and verify that the power LED is ON green.

3.1 Install the Software

IMPORTANT: Administrative rights are required to install the Banner Radar Configuration software.

1. Download the latest version of the software from www.bannerengineering.com/us/en/products/sensors/software/radar-configuration.html.
2. Navigate to and open the downloaded file.
3. Click **Install** to begin the installation process.
4. Depending on your system settings, a popup window may appear prompting to allow Banner Radar Configuration to make changes to your computer. Click **Yes**.
5. Click **Close** to exit the installer.

3.2 Connect to the Sensor

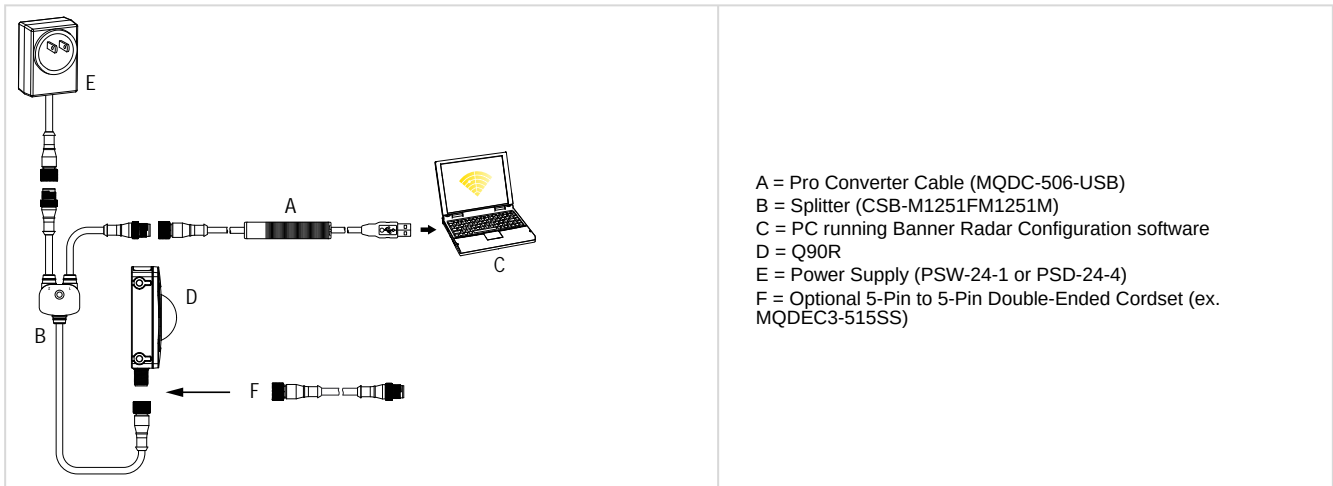

1. Connect the sensor to the splitter cable from the PRO-KIT. See "Configuration Tool " on page 27.
2. Connect the external power and Pro Converter cable to the splitter cable.
3. Connect the Pro Converter cable to the PC.
4. Open the Banner Radar Configuration Software.
5. Go to **Sensor > Connect** on the **Navigation** toolbar.
 The **Connection** screen displays.
6. Select the correct **Sensor Model** and **Com Port** for the sensor.
7. Click **Connect**.
 The **Connection** screen closes and the sensor data displays.

3.3 Software Overview

Easy setup and configuration of range, sensitivity, and output using the Banner Radar Configuration software and Pro Converter Cable.

Figure 6. Banner Radar Configuration Software

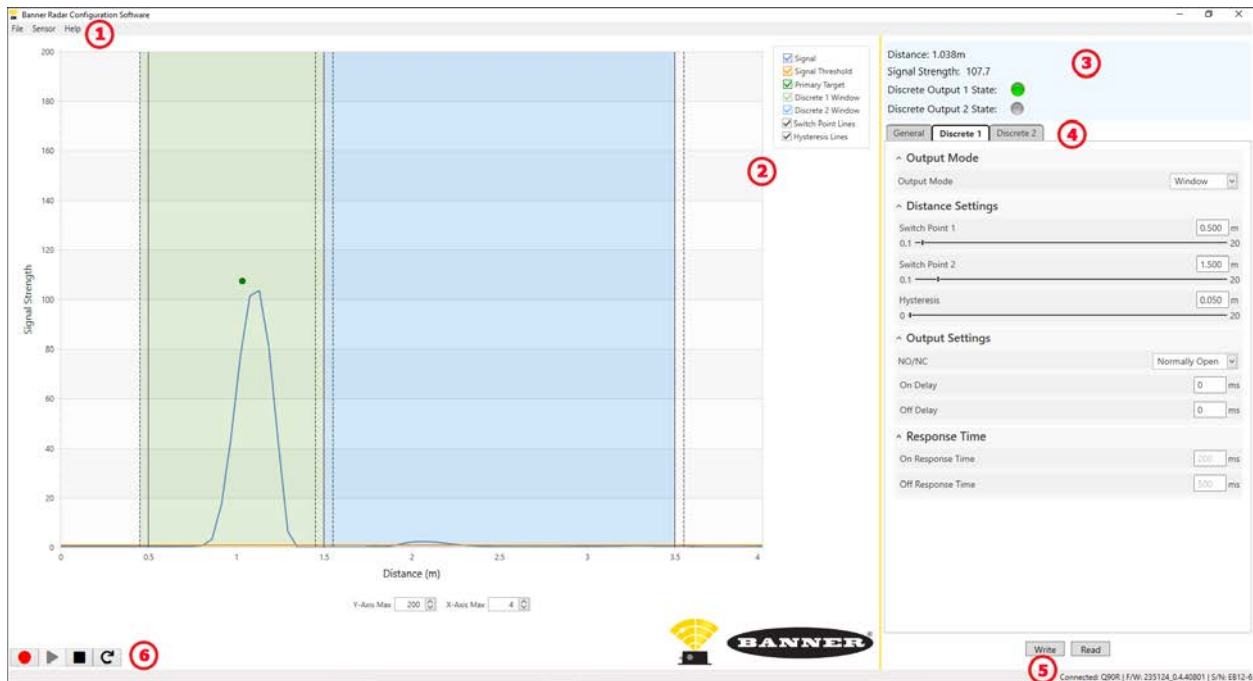

1. Navigation toolbar—Use this toolbar to connect to the sensor, to save or load a configuration, or to reset to factory defaults
2. Live Sensor Data and Legend—Shows the signal strength versus distance for the connected sensor, as well as options to select which data displays on the graph
3. Summary pane—Displays the distance to the target, the signal strength, and the output status
4. Sensor Settings pane—Set the sensor parameters in this pane
5. Status bar—Shows whether the sensor is connected, if a software update is available, and if the sensor data is being recorded to a file
6. Live Sensor Data controls—Use these controls to record, freeze, and play real-time sensor data, and to refresh the sensor connection

Chapter Contents

4.1 Navigation Toolbar..... 10
 4.2 Live Sensor Data and Legend..... 10
 4.3 Summary Pane..... 11
 4.4 Sensor Settings Pane..... 11
 4.5 Live Sensor Data Controls 14
 4.6 Using Measurement Hold Example..... 15

Chapter 4 Banner Radar Configuration Workspace

4.1 Navigation Toolbar

Use this toolbar to connect to the sensor, to save or load a configuration, or to reset to factory defaults.

From the File menu, the following options are available:

Load Config

Load a configuration to the connected sensor. Use this option to set up multiple sensors with the same parameters.

Save Config

Save a configuration to a desired location for future use.

Reset Frequently Used Settings

Resets the software settings without changing the configuration of the attached sensor.

Exit

Exit the Banner Radar Configuration Software.

From the Sensor menu, the following options are available:

Connect

Connect to the sensor.

Disconnect

Disconnect from the sensor.

Factory Reset

Select to perform a factor reset on the sensor. All custom parameters will be lost.

From the Help menu, the following option is available:

About

Select to view the software version number, the copyright notice, and the warranty.

4.2 Live Sensor Data and Legend

The Live Sensor Data area displays the live distance and amplitude signal from the connected radar sensor. The signal strength threshold, switch point, and hysteresis are also plotted. Use these signals to evaluate targets to determine where the signal strength threshold and switch point should be configured for reliable detection.

Use the **Y-Axis Max** and the **X-Axis Max** to adjust the range displayed on the plot.

Legend -- Use the legend to select which data appears on the graph.

Signal

Displays the strength of the signal over distance.

Signal Threshold

Displays the signal strength threshold.

Primary Targets

Represents the signal strength and location of the strongest target inside the switch point.

Analog Window

The range the analog signal represents.

Available on analog models.

Varies by output model.

Discrete 1/2 Window

The range for the discrete output.

Varies by output model.

Switch Pt Lines

Displays the switch point distance.

Hysteresis Lines

Displays the hysteresis distance.

4.3 Summary Pane

The **Summary** pane (blue shaded area) displays **Distance**, **Signal Strength**, and **Output Status**.

Distance

Displays the distance to the target.

Signal Strength

Displays the amount of excess gain of the signal received from the target. The excess gain is relative to the minimum detection threshold (Signal Strength Threshold = 1).

Output Status

Displays whether the output is ON or OFF, or the analog output value (analog models only).

4.4 Sensor Settings Pane

Set parameters for the sensor.

Click **Read** to read the connected sensor's current parameters. Click **Write** to write the parameters to the sensor. Yellow highlight on a parameter's value indicates changes that have not yet been written to the sensor.

4.4.1 General Tab

The following are the parameters on the **General** tab on the **Sensor Settings** pane.

Response Speed

Choose the response speed of the sensor (Slow, Medium, Fast).

Target Selection

Signal Strength Threshold: Choose the threshold for the minimum amount of signal needed to actuate the output.

Target Mode:

Strongest Target—Output responds to the target with the highest signal strength that is over the signal strength threshold.

Nearest Target—Output responds to the nearest target that is over the signal strength threshold.

Advanced Target

Minimum Active Sensing Range: Sensor ignores anything from the face of the sensor to this defined range.

Maximum Active Sensing Range: Sensor ignores anything past this defined range.

Measurement Hold: A rate of change filter to smooth the output and reduce chatter. For more information, see "Using Measurement Hold Example " on page 15.

Maximum Distance Increase Hold Time: The period of time the sensor holds its last measurement and output status if the measurement changes more than the configured max distance increase. Available when **Measurement Hold** is set to enabled.

Maximum Distance Decrease Hold Time: The period of time the sensor holds its last measurement and output status if the measurement changes more than the configured max distance decrease. Available when **Measurement Hold** is set to enabled.

Maximum Distance Increase: The allowed limit the measurement can increase, or move farther away from the sensor, before initiating the **Measurement Hold**. Setting this to zero disables it. Available when **Measurement Hold** is set to enabled.

Maximum Distance Decrease: The allowed limit the measurement can decrease, or move closer to the sensor, before initiating the **Measurement Hold**. Setting this to zero disables it. Available when **Measurement Hold** is set to enabled.

Sensor Polarity

Define the output and remote input signal type.

Sensor Lockout

Remote Input (Gray Wire): Enable or disable the remote input wire.

LED Enable/Disable

Enable or disable the LEDs on the sensor

4.4.2 Analog Tab

The following are the parameters on the **Analog** tab on the **Sensor Settings** pane. This tab is available for analog models.

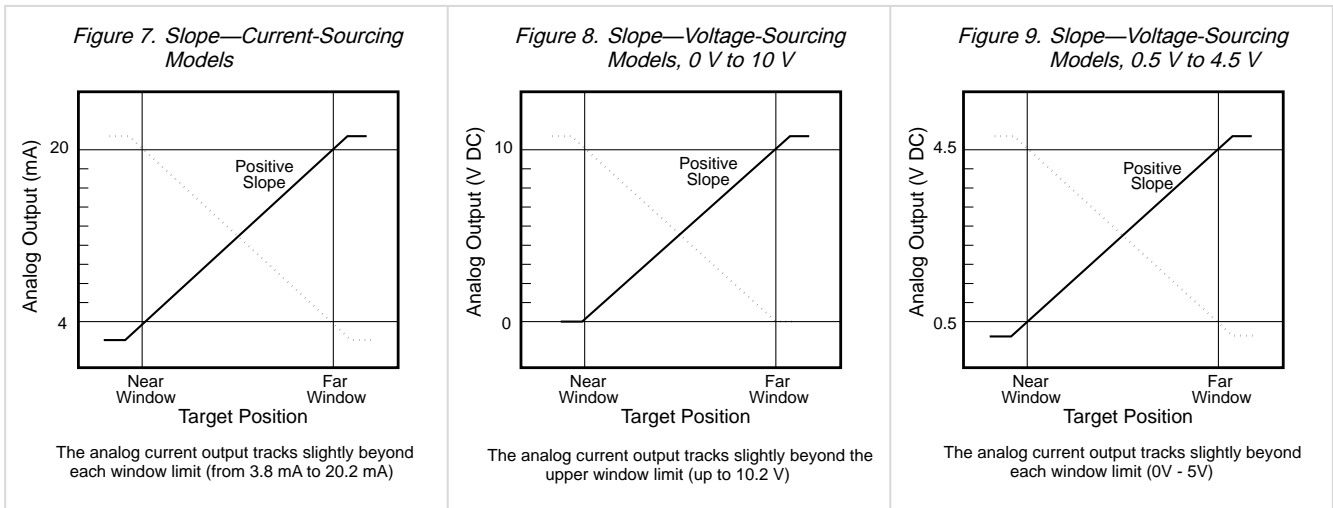

Analog Span

Define the outer limits of the analog range. This can be used to create a positive or negative slope.

Analog output options:

Current: 4 mA to 20 mA

Voltage: 0 V to 10 V or 0.5 V to 4.5 V

Output

Loss-of-Signal: Sets the Analog Output value used by the sensor during a loss of signal. When a signal is restored, measurement resumes.

Hold Last Value—The Analog Output holds the last value indefinitely during a loss of signal.

3.5 mA (0 V)—The Analog Output switches to this value 2 seconds after a loss of signal. For Voltage models, this is 0 V. (Default)

20.5 mA (10.5 V/5 V)—The Analog Output switches to this value 2 seconds after a loss of signal. For Voltage models, this is 10.5 V.

Averaging: Use this menu to set the number of measurements that are averaged together for the analog output. Increasing the averaging improves repeatability but increases the total response speed. The default is 1. The filter can be set to 1, 2, 4, 8, 16, 32, 64, or 128. The total response time is shown under Response Time.

Response Time

Calculates the total response time, taking into account the general response speed and averaging.

Table 2. Analog

Response Speed	Analog Output Filter Setting							
	1	2	4	8	16	32	64	128
	Analog Output Spec (ms)							
Fast	16	32	64	128	256	512	1024	2048
Medium	80	160	320	640	1280	2560	5120	10,240
Slow	200	400	800	1600	3200	6400	1280	2560

4.4.3 Discrete 1 Tab

The following are the parameters on the **Discrete 1** tab on the **Sensor Settings** pane.

Output Mode

Select **Switch Point** or **Window**.

Switch Point: The distance at which the switch point threshold is placed.

Window: Define two set points to create window limits.

Distance Settings

Define the set point(s) and the hysteresis.

Output Settings

NO/NC: Select **Normally Open** or **Normally Closed** from the list.

On Delay: Set an on delay in milliseconds. The maximum time is 60,000 ms.

Off Delay: Set an off delay in milliseconds. The maximum time is 60,000 ms.

Response Time

Calculates the total response time, taking into account the general response speed and on or off delays.

Table 3. Discrete

Response Speed	Discrete Output ON Spec (ms)	Discrete Output OFF Spec (ms)
Fast	50	50
Medium	100	200
Slow	250	550

4.4.4 Discrete 2 Tab

The following are the parameters on the **Discrete 2** tab on the **Sensor Settings** pane. This tab is available for dual discrete models.

Output Mode

Select **Switch Point**, **Window**, **Complementary**, or **Pulse Pro/PFM**.

Switch Point: Set a single switch point for the output to change.

Window: Define two setpoints to create window limits.

Complementary: Output 2 will be the opposite of Output 1.

Pulse Pro/PFM: Pulse Pro/PFM output to interface with Banner lights or a PLC with PFM inputs.

Distance Settings

Available when Output Mode is set to **Switch Point** or **Window**.

Define the set point(s) and the hysteresis.

Output Settings

Available when Output Mode is set to **Switch Point** or **Window**.

NO/NC: Select **Normally Open** or **Normally Closed** from the list.

On Delay: Set an on delay in milliseconds. The maximum time is 60,000 ms.

Off Delay: Set an off delay in milliseconds. The maximum time is 60,000 ms.

Response Time

Calculates the total response time, taking into account the general response speed and on or off delays.

Table 4. Discrete

Response Speed	Discrete Output ON Spec (ms)	Discrete Output OFF Spec (ms)
Fast	50	50
Medium	100	200
Slow	250	550

Pulse Pro/PFM Settings

Available when Output Mode is set to **Pulse Pro/PFM**.

The Q90R can generate pulses whose frequency are proportional to the sensor's measured distance, thereby providing a method for representing an analog signal with only a discrete counter. The sensing range of the sensor is scaled from 100 Hz to 600 Hz. 100 Hz equals the near range limit of the sensor, and 600 Hz equals the far sensing range limit. An output of 50 Hz or 650 Hz (user defined in the software) represents a loss of signal condition where there is no target or the target is out of range. This output can be tied directly to a number of Banner lights for visual feedback without the need for a controller.

100 Hz: Define the near sensing range limit of the Pulse Pro range.

600 Hz: Define the far sensing range limit of the Pulse Pro range.

Loss-of-Signal: Sets the value used by the sensor during a loss of signal. When a signal is restored, measurement resumes.

Hold last value—The Discrete 2 Output holds the last value indefinitely during a loss of signal.

50 Hz—The Discrete 2 Output switches to this value 2 seconds after a loss of signal.

650 Hz—The Discrete 2 Output switches to this value 2 seconds after a loss of signal.

4.5 Live Sensor Data Controls

After connecting to the sensor, data sampling begins automatically (but not recording).

To stop data sampling, click  **Stop**.

To restart data sampling, click  **Play**. This only samples data from the sensor and displays it on the plot; it does not record the data to a log file.

To record data to a log file, click  **Record**. The log file selection prompt displays. Save the log file as desired. The log file format is .csv.

If communication to the sensor is lost, click  **Refresh Device Connection** to reconnect.

4.6 Using Measurement Hold Example

Figure 10. Measurement Hold (The hold time is set to 1 second)

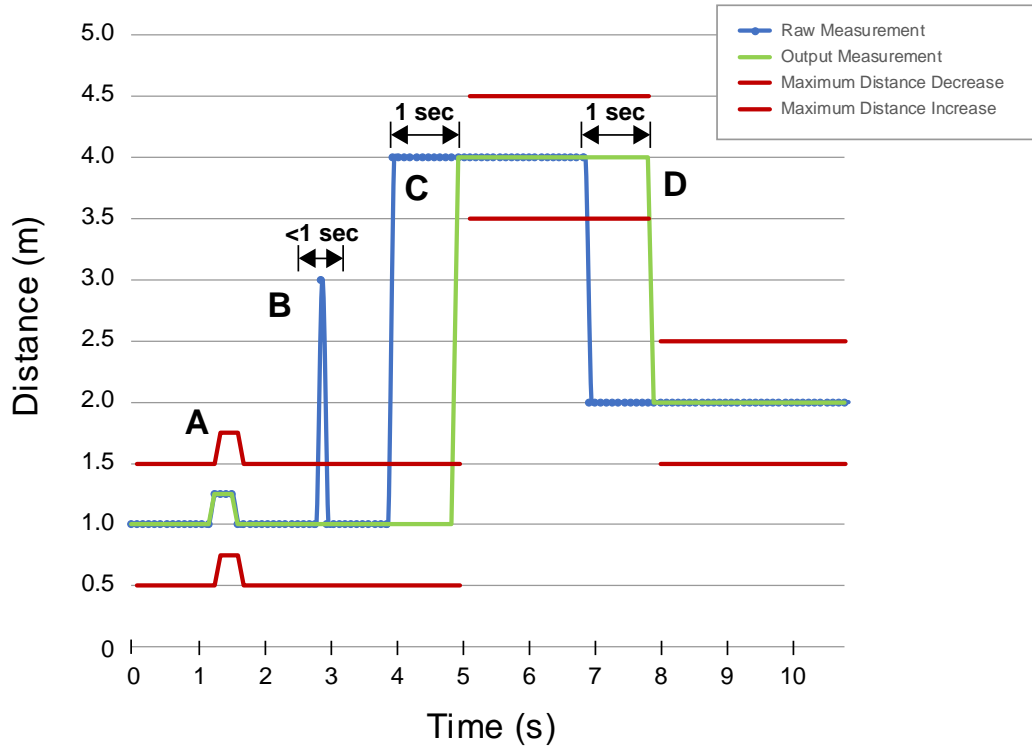

A.	The Max Distance Change threshold (red lines) adapts based on the previous Raw Measurement sample (blue lines) as long as that sample was within the previous thresholds.
B.	The temporary distance spike in the Raw Measurement (blue lines) is filtered out because the distance increase was outside of the Max Distance Change (red lines). The Output Measurement (green lines) will hold its last measurement.
C.	The Raw Measurement change (blue lines) is greater than the Max Distance Change (red lines) so the Output Measurement (green lines) holds its previous value while the Raw Measurement is beyond the Max Distance Change. After the 1 second Hold Time expires, the Output Measurement and Max Distance Change thresholds are updated based on the next Raw Measurement value.
D.	The Raw Measurement (blue lines) drops down to a value below the Max Distance Change (red lines) so the Output Measurement (green lines) holds its value for the Hold Time. After the 1 second Hold Time expires, the Output Measurement and Max Distance Change thresholds are updated based on the next Raw Measurement value.

Chapter Contents

5.1 Banner Radar Configuration Software	16
5.2 IO-Link Interface.....	16
5.3 Remote Input.....	16
5.4 Remote Teach	19
5.5 Remote Setup	19
5.6 Reset the Sensor to Factory Defaults	21
5.7 Factory Default Settings	22

Chapter 5 Configuring a Sensor

5.1 Banner Radar Configuration Software

Use the Banner Radar Configuration software and PRO-KIT to set up the R-GAGE sensor.

For more information visit www.bannerengineering.com/us/en/products/sensors/software/radar-configuration.html.

5.2 IO-Link Interface

IO-Link is a point-to-point communication link between a master device and sensor. Use IO-Link to parameterize sensors and transmit process data automatically.

For the latest IO-Link protocol and specifications, see www.io-link.com.

Each IO-Link device has an IODD (IO Device Description) file that contains information about the manufacturer, article number, functionality etc. This information can be easily read and processed by the user. Each device can be unambiguously identified via the IODD as well as via an internal device ID. Download the Q90R's IO-Link IODD package (p/n 237876 for analog models and p/n 237875 for dual discrete models) from Banner Engineering's website at www.bannerengineering.com.

Banner has also developed Add On Instruction (AOI) files to simplify ease-of-use between the Q90R, multiple third-party vendors' IO-Link masters, and the Logix Designer software package for Rockwell Automation PLCs. Three types of AOI files for Rockwell Allen-Bradley PLCs are listed below. These files and more information can be found at www.bannerengineering.com.

Process Data AOIs—These files can be used alone, without the need for any other IO-Link AOIs. The job of a Process Data AOI is to intelligently parse out the Process Data word(s) in separate pieces of information. All that is required to make use of this AOI is an EtherNet/IP connection to the IO-Link Master and knowledge of where the Process Data registers are located for each port.

Parameter Data AOIs—These files require the use of an associated IO-Link Master AOI. The job of a Parameter Data AOI, when working in conjunction with the IO-Link Master AOI, is to provide quasi-realtime read/write access to all IO-Link parameter data in the sensor. Each Parameter Data AOI is specific to a given sensor or device.

IO-Link Master AOIs—These files require the use of one or more associated Parameter Data AOIs. The job of an IO-Link Master AOI is to translate the desired IO-Link read/write requests, made by the Parameter Data AOI, into the format a specific IO-Link Master requires. Each IO-Link Master AOI is customized for a given brand of IO-Link Master.

Add and configure the relevant Banner IO-Link Master AOI in your ladder logic program first; then add and configure Banner IO-Link Device AOIs as desired, linking them to the Master AOI as shown in the relevant AOI documentation.

5.3 Remote Input

Use the remote input to program the sensor remotely.

The remote input provides limited programming options and is Active High. This can be configured for Active Low in the Banner Radar Configuration software by changing the **Sensor Polarity**. For Active High, connect the gray input wire to V+ (10 V DC to 30 V DC), with a remote switch connected between the wire and V+. For Active Low, connect the gray input wire to ground (0 V DC) with a remote switch connected between the wire and ground.

The remote input wire is disabled by default. Pulse the remote input wire 10 times or use the Banner Radar Configuration software to enable the feature. After enabling the remote input feature, pulse the remote input according to the diagram and the instructions provided in this manual. Remote teach can also be performed using the button on the Pro Converter Cable.

The length of the individual programming pulses is equal to the value T: **0.04 seconds ≤ T ≤ 0.8 seconds**.

Exit remote programming modes by setting the remote input Low for longer than 2 seconds or by waiting for 60 seconds.

Figure 11. Remote Input Map

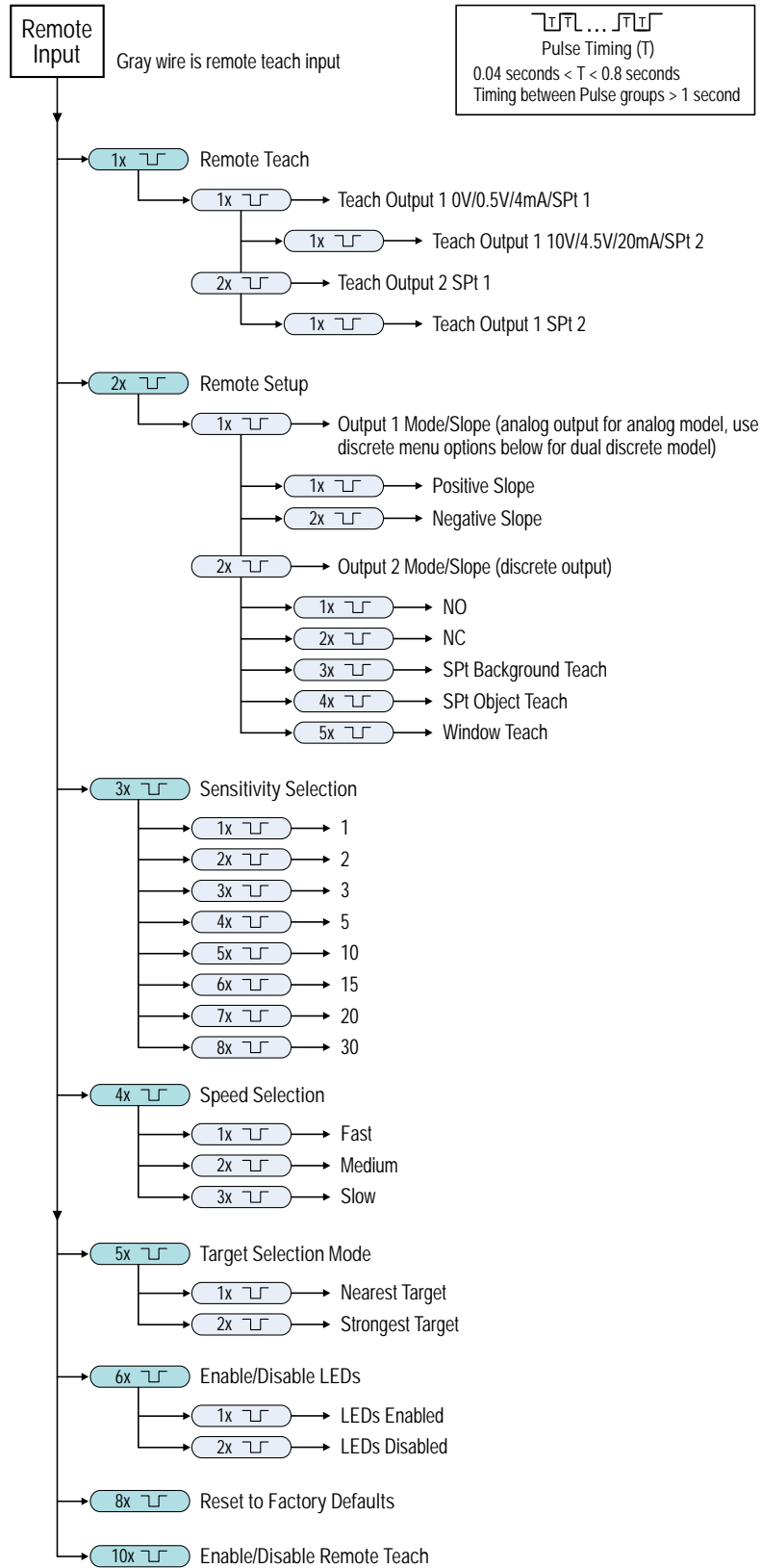

NOTE: If a factory reset is performed through the Banner Radar Configuration Software, the remote input wire becomes disabled (factory default setting). If the sensor is returned to factory defaults by using the remote input wire, the input wire remains enabled and the rest of the settings are restored to factory defaults.

5.4 Remote Teach

Use the following procedure to teach the first and second switch points.

1. Pulse the remote input once. The green Power LED flashes, the amber LED is off, and the red LED is off.
2. Present the first point.
3. Teach the switch point.

Action		Result
Single-pulse the remote input.		<p>Teach Accepted</p> <p>The green Power LED is off, the yellow LED of the output being taught flashes while the yellow LED of the output not being taught is off. The red LED indicates signal strength.</p> <p>Teach Not Accepted</p> <p>The green Power LED continues to flash, the yellow LED is off, and the red LED is off.</p> <p>Retry teaching the first point.</p>

4. Present the second point.
5. Teach the switch point.

Action		Result
Single-pulse the remote input.		<p>The green Power LED turns on.</p> <p>Teach Accepted</p> <p>The sensor returns to run mode.</p> <p>Teach Not Accepted</p> <p>The green Power LED remains off, the yellow LED of the output being taught continues to flash while the yellow LED of the output not being taught is off.</p> <p>Retry teaching the second point.</p>

5.5 Remote Setup

Use Remote Setup to set the output mode to set normally open or normally closed, change the analog slope, or set the teach mode.

While in remote set up, pulsing the remote wire once configures output 1. For analog models, the slope of the output changes. For discrete output, output 1 and output 2 options are identical.

Changing the Output Mode using remote input affects both the output configuration (normally open versus normally closed) and the Teach mode. The output configuration change takes effect immediately and can be used to change the output between normally open and normally closed or the analog slope without changing the switch point distance. The change in Teach mode does not immediately change the switch point location, but will affect the behavior of the next remote Teach.

5.5.1 Analog Teach Modes

The default is to teach two separate points. With a positive slope, the first taught point is 4 mA and the second taught point is 20 mA.

If the two taught points are within 100 mm or less, the sensor views them as the same point. It considers that point as the 20 mA spot and sets the 4 mA spot at 150 mm. If a taught point is within the dead zone, the sensor sets that point at 150 mm.

5.5.2 Discrete Teach Modes

Teaching two separate points creates a window around that range.

Background Teach—Teaching the same point twice (points within 100 mm of each other) sets the switch point 200 mm in front of the taught point.

Object Teach—Teaching the same point twice (points within 100 mm of each other) sets the switch point 100 mm behind the taught point.

Window Teach—Teaching the same point twice (points within 100 mm of each other) sets a window ±50 mm on either side of the taught point, for a total window size of 100 mm.





5.5.3 Set the Sensitivity

Use Sensitivity Selection to set the signal strength threshold.

1. Access Sensitivity Selection.

Action		Result
Triple-pulse the remote input.		The green power LED flashes slowly.

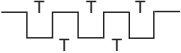
2. Select the desired signal threshold.

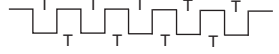
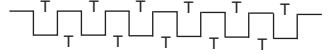
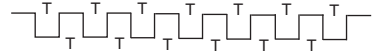
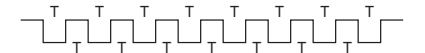
Action		TEACH Mode	Result
1		Signal Strength Threshold = 1	The signal threshold is set and the green power LED flashes equal to the number of pluses, pauses, and then flashes equal to the number of pulses a second time. Then the sensor exits remote teach and returns to run mode.
2		Signal Strength Threshold = 2	
3		Signal Strength Threshold = 3	
4		Signal Strength Threshold = 5	
5		Signal Strength Threshold = 10	
6		Signal Strength Threshold = 15	
7		Signal Strength Threshold = 20	
8		Signal Strength Threshold = 30	



5.5.4 Set the Speed

Use Speed Selection to set the speed of the sensor.

1. Access Speed Selection.

Action		Result
Four-pulse the remote input.		The green power LED flashes slowly.

2. Select the desired signal threshold.

Action		TEACH Mode	Result
Pulses			
1		Speed = Fast	The speed is set and the power LED flashes equal to the number of pluses, pauses, and then flashes equal to the number of pulses a second time. The sensor exits remote teach and returns to run mode.
2		Speed = Medium	
3		Speed = Slow	



5.5.5 Target Selection Mode

Use Target Selection to set the target that the output sees.

1. Access Target Selection mode.

Action		Result
Five-pulse the remote input.		The green power LED flashes slowly.

2. Select the desired signal threshold.

Action		TEACH Mode	Result
Pulses			
1		Nearest Target—Output responds to the nearest target that is over the signal strength threshold.	The signal threshold is set and the green power LED flashes equal to the number of pluses, pauses, and then flashes equal to the number of pulses a second time. Then the sensor exits remote teach and returns to run mode
2		Strongest Target—Output responds to the target with the highest signal strength that is over the signal strength threshold.	

5.6 Reset the Sensor to Factory Defaults

Reset the sensor to factory default settings using one of two methods.

NOTE: If a factory reset is performed through the Banner Radar Configuration Software, the remote input wire becomes disabled (factory default setting). If the sensor is returned to factory defaults by using the remote input wire, the input wire remains enabled and the rest of the settings are restored to factory defaults.

To reset using the Banner Radar Configuration software, go to **Sensor > Factory Reset**. The sensor indicators flash once, the sensor is reset back to the factory default settings, and a confirmation message displays.

To reset using the remote input, eight-pulse the remote input to apply the factory defaults.

5.7 Factory Default Settings

Table 5. General Tab Default Settings

Setting	Factory Default
Response Speed	Medium
Signal Strength Threshold	1.0
Target Mode	Nearest Target
Measurement Hold	Disabled
Discrete Output & Remote Input	PNP
Remote Input Wire	Disabled

Table 6. Analog Tab Default Settings

Setting	Factory Default
Range	4 mA to 20 mA (0 V to 10 V)
4mA/0V Point	0.15 m (0.49 ft)
20mA/10V Point	20.0 m (65.6 ft)
Loss of Signal	3.5 mA (0 V)
Averaging	1x (no averaging)

Table 7. Discrete 1 Tab Default Settings

Setting	Factory Default
Output Mode	Switch Point
Setpoint 1	20.0 m (65.6 ft)
Hysteresis	0.05 m (2 in)
NO/NC	Normally Open
On Delay	0 ms
Off Delay	500 ms

Table 8. Discrete 2Tab Default Settings

Setting	Factory Default
Output Mode	Switch Point
Setpoint 1	20.0 m (65.6 ft)
Hysteresis	0.05 m (2 in)
NO/NC	Normally Open
On Delay	0 ms
Off Delay	500 ms

Chapter Contents

6.1 FCC Part 15 Class A for Intentional Radiators 24
 6.2 Industry Canada Statement for Intentional Radiators 25
 6.3 Dimensions..... 25
 6.4 Beam Patterns..... 25

Chapter 6 Specifications

Range

The sensor can detect an object at the following range, depending on the material of the target: 0.15 m to 20 m (0.5 ft to 65.6 ft)

Operating Principle

Frequency-modulated continuous-wave (FMCW) radar

Operating Frequency

60 to 61.5 GHz

Supply Voltage (Vcc)

Analog Voltage models: 12 V DC to 30 V DC
 Analog Current and Dual Discrete models: 10 V DC to 30 V DC
 Use only with a suitable Class 2 power supply (UL) or Limited Power Supply (CE)

Power and Current Consumption, exclusive of load

Power consumption: < 2.4 W
Current consumption: <100 mA at 24 V DC

Supply Protection Circuitry

Protected against reverse polarity and transient overvoltages

Linearity

<± 10 mm at < 300 mm
 <± 4 mm at > 300 mm
 Reference target with RCS = 1m²

Delay at Power-up

< 2 s

Output Configuration

Analog Outputs:
-Current models
 Discrete Output (Black Wire): IO-Link, push/pull output, configurable PNP or NPN output
 Analog output (White Wire): 4 mA to 20 mA
-Voltage models
 Discrete Output (Black Wire): IO-Link, push/pull output, configurable PNP or NPN output
 Analog output (White Wire): Configurable 0 V to 10 V or 0.5 V to 4.5 V
-Dual Discrete models
 Discrete Output 1 (Black Wire): IO-Link, push/pull output, configurable PNP or NPN output
 Discrete Output 2 (White Wire): Configurable PNP or NPN, or Pulse Frequency Modulated (PFM) output

Repeatability

2 mm
 10 mm at Excess Gain < 10x

Maximum Transmitting Power

Peak EIRP: 100 mW, 20 dBm

Output Protection

Protected against output short-circuit

Remote Input

Allowable Input Voltage Range: 0 to Vsupply
 Active High (internal weak pull-down): High state > (Vsupply - 2.25 V) at 2 mA maximum
 Active Low (internal weak pull-up): Low state < 2.25 V at 2 mA maximum

Response Time

Analog update rate: 15 ms
 Discrete output response: 50 ms
 Speeds given for fast mode.

Indicators

Power LED: Green, power on
Signal Strength LED:
 Green Flash: weak signal
 Green Solid: 4x threshold
Output LEDs: Amber, target within taught analog span/ discrete output status

Construction

Housing: Aluminum
Window: Polycarbonate

Connections

Integral M12 quick disconnect
 Models with a quick disconnect require a mating cordset

Vibration and Mechanical Shock

All models meet MIL-STD-202G, Method 201A (Vibration: 10 Hz to 60 Hz, 0.06 inch (1.52 mm) double amplitude, 2 hours each along X, Y and Z axes) requirements. Also meets IEC 60947-5-2 (Shock: 30G 11 ms duration, half sine wave) requirements. Method 213B conditions H&I. Shock: 75G with device operating; 100G for non-operation

Operating Temperature

Standard model: -40 °C to +65 °C (-40 °F to +149 °F)

Temperature Effect

<±10 mm from -40 °C to +65 °C (-40 °F to +149 °F)

Environmental Rating

IP67 per IEC60529
 IEC IP69K per BS/ISO 20653:2013

Country of Origin

USA

Certifications



IND. CONT. EQ. E526767



Banner Engineering BV
Park Lane, Culliganlaan 2F bus 3
1831 Diegem, BELGIUM



Turck Banner LTD Blenheim House
Blenheim Court
Wickford, Essex SS11 8YT
GREAT BRITAIN

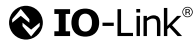

ETSI EN 305 550 V2.1.0
ETSI EN 305 550-1 V.1.2.1
ETSI EN 305 550-2 V.1.2.1
FCC ID: UE3Q90R
IC: 7044A-Q90R6

Install where not accessible by unauthorized personnel.

The device shall only be accessible for adjustment, programming, or maintenance.

The device was evaluated for IK08 impact energy in accordance with IEC 62262.

Advanced Capabilities



Output Ratings

Analog Outputs:

- **Current Output (Q90R....-I.. models):** 1 kΩ maximum load resistance at 24 V; maximum load resistance = $[(V_{cc} - 4.5)/0.02 \Omega]$
- **Voltage Output (Q90R....-U.. models):** 2.5 kΩ minimum load resistance
- **Current rating** = 50 mA maximum each

Black wire specifications per configuration		
IO-Link Push/Pull	Output High	$\geq V_{supply} - 2.5 V$
	Output Low	$\leq 2.5 V$
PNP	Output High	$\geq V_{supply} - 2.5 V$
	Output Low	$\leq 1V$ (loads $\leq 1 \text{ Meg}\Omega$)
NPN	Output High	$\geq V_{supply} - 2.5 V$
	Output Low	$\leq 2.5 V$

White wire specifications per configuration		
PNP	Output High	$\geq V_{supply} - 2.5 V$
	Output Low	$\leq 2.5 V$ (loads $\leq 70 \text{ k}\Omega$)
NPN	Output High	$\geq V_{supply} - 2.5 V$
	Output Low	$\leq 2.5 V$

6.1 FCC Part 15 Class A for Intentional Radiators

This equipment has been tested and found to comply with the limits for a Class A digital device, pursuant to Part 15 of the FCC Rules. These limits are designed to provide reasonable protection against harmful interference when the equipment is operated in a commercial environment. This equipment generates, uses, and can radiate radio frequency energy and, if not installed and used in accordance with the instruction manual, may cause harmful interference to radio communications. Operation of this equipment in a residential area is likely to cause harmful interference in which case the user will be required to correct the interference at his own expense.

(Part 15.21) Any changes or modifications not expressly approved by the party responsible for compliance could void the user's authority to operate this equipment.

6.2 Industry Canada Statement for Intentional Radiators

This device contains licence-exempt transmitter(s)/receiver(s) that comply with Innovation, Science and Economic Development Canada's licence-exempt RSS(s). Operation is subject to the following two conditions:

1. This device may not cause interference.
2. This device must accept any interference, including interference that may cause undesired operation of the device.

Cet appareil contient des émetteurs/récepteurs exemptés de licence conformes à la norme Innovation, Sciences, et Développement économique Canada. L'exploitation est autorisée aux deux conditions suivantes:

1. L'appareil ne doit pas produire de brouillage.
2. L'utilisateur de l'appareil doit accepter tout brouillage radioélectrique subi, même si le brouillage est susceptible d'en compromettre le fonctionnement.

6.3 Dimensions

All measurements are listed in millimeters [inches], unless noted otherwise.

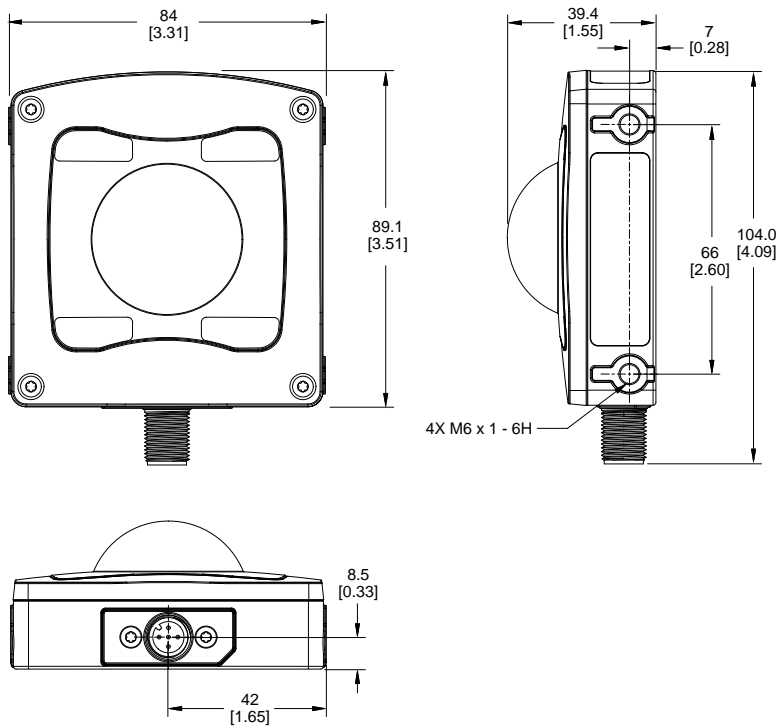

6.4 Beam Patterns

The beam pattern of the radar sensor is dependent on the radar cross section (RCS) of the target.

The beam pattern graphs represent Standard Mode and are guides for representative object detection capabilities based on different-sized radar cross sections and corresponding example real-world targets. Use the following charts as a starting point in application setup. Note that applications vary.

- Use the Beam Width versus Distance chart to understand where corresponding objects can be detected. Adjusting the signal strength threshold also affects the beam pattern when the target is constant.
- Use the Beam Width versus Degrees chart to help determine how much the target can tilt from 90 degrees while still maintaining detection.

Unless otherwise specified, the following beam patterns are shown with Signal Strength Threshold = 1.

Figure 12. Typical beam pattern, in millimeters, on representative targets

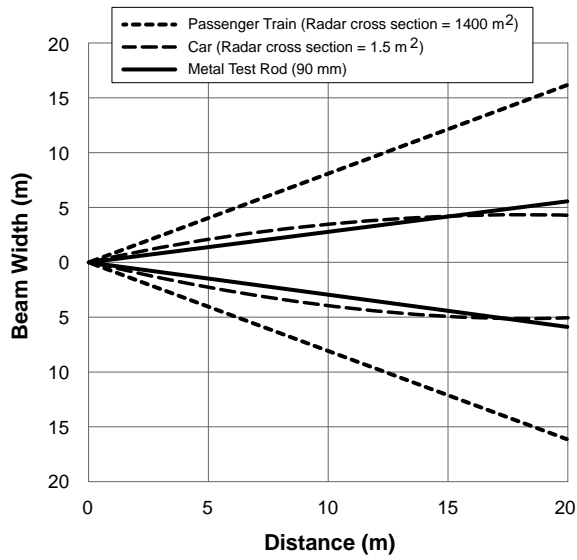
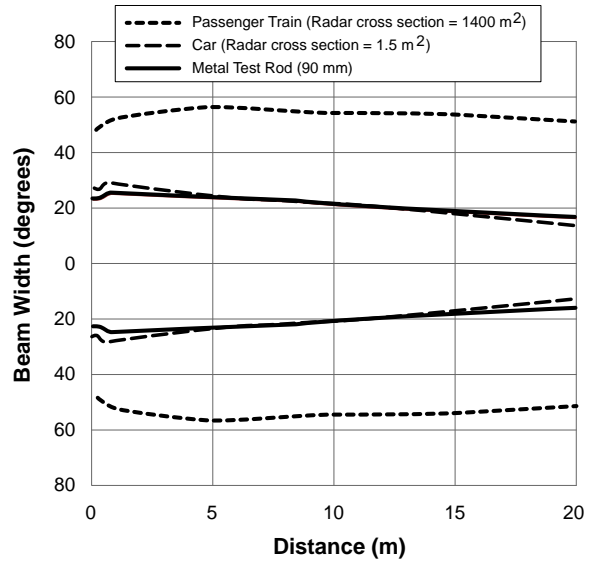

Figure 13. Typical beam pattern, in degrees, on representative targets



Chapter Contents

7.1 Configuration Tool 27
 7.2 Cordsets 27
 7.3 Brackets 28
 7.4 IO-Link Masters 29

Chapter 7 Accessories

7.1 Configuration Tool

PRO-KIT

Includes:

- Pro Converter Cable (MQDC-506-USB)
- Splitter (CSB-M1251FM1251M)
- Power Supply (PSW-24-1)

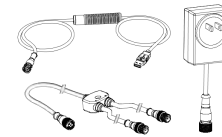

7.2 Cordsets

5-Pin Threaded M12 Cordsets with Shield—Single Ended				
Model	Length	Style	Dimensions	Pinout (Female)
MQDEC2-506	2 m (6.56 ft)	Straight		<p>1 = Brown 2 = White 3 = Blue 4 = Black 5 = Gray</p>
MQDEC2-515	5 m (16.4 ft)			
MQDEC2-530	9 m (29.5 ft)			
MQDEC2-550	15 m (49.2 ft)			
MQDEC2-575	23 m (75.44 ft)			
MQDEC2-5100	30.5 m (100 ft)			
MQDEC2-506RA	2 m (6.56 ft)	Right-Angle		<p>1 = Brown 2 = White 3 = Blue 4 = Black 5 = Gray</p>
MQDEC2-515RA	5 m (16.4 ft)			
MQDEC2-530RA	9 m (29.5 ft)			
MQDEC2-550RA	15 m (49.2 ft)			
MQDEC2-575RA	23 m (75.44 ft)			
MQDEC2-5100RA	31 m (101.68 ft)			

5-Pin Male Threaded and 5-Pin Female Quick Disconnect M12 Cordset with Shield—Double Ended				
Model	Length "L1"	Style	Pinout (Male)	Pinout (Female)
MQDEC3-503SS	0.91 m (2.99 ft)	Female Straight/Male Straight		
MQDEC3-506SS	1.83 m (6 ft)			
MQDEC3-515SS	4.58 m (15 ft)			
MQDEC3-530SS	9.2 m (30.2 ft)			

Continued on page 28

Continued from page 27

5-Pin Male Threaded and 5-Pin Female Quick Disconnect M12 Cordset with Shield—Double Ended				
Model	Length "L1"	Style	Pinout (Male)	Pinout (Female)
			<p>1 = Brown 2 = White 3 = Blue</p>	<p>4 = Black 5 = Gray</p>

5-Pin Threaded M12 Splitter Cordset with Flat Junction				
Model	Trunk (Male)	Branches (Female)	Pinout (Male)	Pinout (Female)
CSB-M1251M1251B	0.3 m (0.98 ft)	0.3 m (0.98 ft)		
			<p>1 = Brown 2 = White 3 = Blue</p>	<p>4 = Black 5 = Gray</p>

NOTE: The splitter in the PRO-KIT has two male and one female connectors. The CSB-M1251M1251B splitter has one male and two female connectors. Use the CSB-M1251M1251B to connect the sensor to power and a one of the Banner Pro lights with the Pulse Pro output.

7.3 Brackets

SMBAMSQ90R

- Adjustable mounting bracket
- 14-Gauge 304 stainless steel
- M6 × 1 mounting hardware included

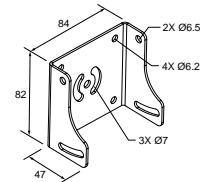

SMBRAQ90R

- Right-angle mounting bracket
- 14-Gauge 304 stainless steel
- M6 × 1 mounting hardware included

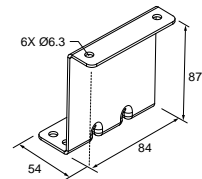

SMBMAG3

- 3.2 inch diameter magnet with 95 lbs pull force
- Use with LMBWLC90PT, SMBAMS70AS, SMBAMSQ90R bracket
- Hardware for mounting to bracket included



NOTE: Use SMBMAG3 with SMBAMSQ90R.

7.4 IO-Link Masters

DXMR110-8K Series Controller IO-Link Master

- Two female M12 D-Code Ethernet connectors for daisy chaining and communication to a higher-level control system
- Eight female M12 connections for IO-Link master connections
- One male M12 connection for incoming power, one female M12 connection for daisy chaining power



DXMR90-4K Series Controller IO-Link Master

- One female M12 D-Code Ethernet connector
- Four female M12 connections for IO-Link master connections
- One male M12 (Port 0) connection for incoming power and Modbus RS-485, one female M12 connection for daisy chaining Port 0 signals



R45C-2K-MQ 2-Port IO-Link Master/Modbus Converter

- Connects two IO-Link devices and provides access via Modbus RTU interface
- 5-pin M12 male quick-disconnect connector
- Two 4-pin M12 female quick-disconnect connectors

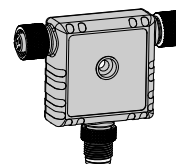

R90C-4K-MQ 4-Port IO-Link Master/Modbus Converter

- Connects four IO-Link devices and provides access via Modbus RTU interface
- 5-pin M12 male quick-disconnect connector
- Four 4-pin M12 female quick-disconnect connectors

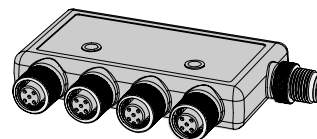

Chapter Contents

8.1 Update the Software..... 30
 8.2 Repairs 30
 8.3 Contact Us..... 31
 8.4 Banner Engineering Corp. Software Copyright Notice..... 31
 8.5 Banner Engineering Corp Limited Warranty..... 31

Chapter 8 Product Support

8.1 Update the Software

Use this procedure to update the Banner Radar Configuration Software.

The Banner Radar Configuration Software automatically looks for updated software versions. The symbol  in the lower right corner indicates that a software update is available.

Figure 14. Software Update Available



1. Click  in the lower right corner of the software.
 The Banner Radar Configuration Software Update screen displays.

Figure 15. Banner Radar Configuration Software Update Screen

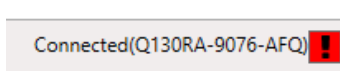

2. Click **Upgrade** to begin the process.
 The Banner Radar Configuration Software closes and an installer (BannerRadarConfigInstaller.exe) downloads to the desktop.

NOTE: If changes have not been written to the sensor, the system asks whether you want to exit the program. Click **No** to stop the update process and return to the Software. Write the changes to the sensor, then return to step 1, above, to update the Software.

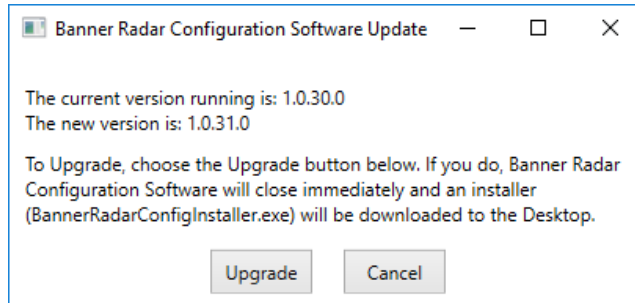
3. Navigate to and open the file BannerRadarConfigInstaller.exe.
4. Depending on your system settings, a popup window may appear prompting to allow Banner Radar Configuration Software to make changes to your computer. Click **Yes**.
5. Click **Close** to exit the installer.

The software update is complete.

8.2 Repairs

Contact Banner Engineering for troubleshooting of this device. **Do not attempt any repairs to this Banner device; it contains no field-replaceable parts or components.** If the device, device part, or device component is determined to be defective by a Banner Applications Engineer, they will advise you of Banner's RMA (Return Merchandise Authorization) procedure.

IMPORTANT: If instructed to return the device, pack it with care. Damage that occurs in return shipping is not covered by warranty.

You may be asked to provide the configuration file and the data log file (.cfg) to aid in troubleshooting.

8.3 Contact Us

Banner Engineering Corp. headquarters is located at: 9714 Tenth Avenue North | Minneapolis, MN 55441, USA | Phone: + 1 888 373 6767

For worldwide locations and local representatives, visit www.bannerengineering.com.

8.4 Banner Engineering Corp. Software Copyright Notice

© Banner Engineering Corp., All Rights Reserved.

<https://www.bannerengineering.com/us/en/company/terms-and-conditions.html>

Disclaimer of Warranties. This software is provided "AS-IS." To the maximum extent permitted by applicable law, Banner, its affiliates, and its channel partners disclaim all warranties, expressed or implied, including any warranty that the software is fit for a particular purpose, title, merchantability, data loss, non-interference with or non-infringement of any intellectual property rights, or the accuracy, reliability, quality or content in or linked to the services. Banner and its affiliates and channel partners do not warrant that the services are secure, free from bugs, viruses, interruption, errors, theft or destruction. If the exclusions for implied warranties do not apply to you, any implied warranties are limited to 60 days from the date of first use of this software.

Limitation of Liability and Indemnity. Banner, its affiliates and channel partners are not liable for indirect, special, incidental, punitive or consequential damages, damages relating to corruption, security, loss or theft of data, viruses, spyware, loss of business, revenue, profits, or investment, or use of software or hardware that does not meet Banner minimum systems requirements. The above limitations apply even if Banner and its affiliates and channel partners have been advised of the possibility of such damages. This Agreement sets forth the entire liability of Banner, its affiliates and your exclusive remedy with respect to the software use.

8.5 Banner Engineering Corp Limited Warranty

Banner Engineering Corp. warrants its products to be free from defects in material and workmanship for one year following the date of shipment. Banner Engineering Corp. will repair or replace, free of charge, any product of its manufacture which, at the time it is returned to the factory, is found to have been defective during the warranty period. This warranty does not cover damage or liability for misuse, abuse, or the improper application or installation of the Banner product.

THIS LIMITED WARRANTY IS EXCLUSIVE AND IN LIEU OF ALL OTHER WARRANTIES WHETHER EXPRESS OR IMPLIED (INCLUDING, WITHOUT LIMITATION, ANY WARRANTY OF MERCHANTABILITY OR FITNESS FOR A PARTICULAR PURPOSE), AND WHETHER ARISING UNDER COURSE OF PERFORMANCE, COURSE OF DEALING OR TRADE USAGE.

This Warranty is exclusive and limited to repair or, at the discretion of Banner Engineering Corp., replacement. **IN NO EVENT SHALL BANNER ENGINEERING CORP. BE LIABLE TO BUYER OR ANY OTHER PERSON OR ENTITY FOR ANY EXTRA COSTS, EXPENSES, LOSSES, LOSS OF PROFITS, OR ANY INCIDENTAL, CONSEQUENTIAL OR SPECIAL DAMAGES RESULTING FROM ANY PRODUCT DEFECT OR FROM THE USE OR INABILITY TO USE THE PRODUCT, WHETHER ARISING IN CONTRACT OR WARRANTY, STATUTE, TORT, STRICT LIABILITY, NEGLIGENCE, OR OTHERWISE.**

Banner Engineering Corp. reserves the right to change, modify or improve the design of the product without assuming any obligations or liabilities relating to any product previously manufactured by Banner Engineering Corp. Any misuse, abuse, or improper application or installation of this product or use of the product for personal protection applications when the product is identified as not intended for such purposes will void the product warranty. Any modifications to this product without prior express approval by Banner Engineering Corp will void the product warranties. All specifications published in this document are subject to change; Banner reserves the right to modify product specifications or update documentation at any time. Specifications and product information in English supersede that which is provided in any other language. For the most recent version of any documentation, refer to: www.bannerengineering.com.

For patent information, see www.bannerengineering.com/patents.

Index

A

analog TEACH modes [20](#)
advanced target [11](#)
analog tab [12](#)
averaging [12](#)

H

hold time [11](#)

I

IO-Link [16](#)

L

lockout [11](#)

M

minimum active sensing range [11](#)
maximum active sensing range [11](#)
measurement hold [11](#)
maximum distance increase [11](#)
maximum distance decrease [11](#)

O

output [12](#)

P

polarity [11](#)

R

response speed [11](#)
response time [12](#)

S

Sensor Settings [11](#)
software [16](#)
sensor polarity [11](#)
sensor lockout [11](#)

T

TEACH modes [20](#)
target selection [11](#)
tab
 analog [12](#)

 [LinkedIn](#)

 [Twitter](#)

 [Facebook](#)

