

Description

The ABM7 series of quartz crystals offers fundamental oscillation in the frequency range of 8MHz to 48MHz. Tight frequency tolerance and temperature stability options are available, over extended operating temperature ranges up to -40°C to +105°C. The ABM7 Series is offered in an industry standard 6.0mm x 3.5mm x 1.4mm two pad SMD glass-seal package.



Features

- Superior heat-resistant glass sealing
- Hermetically seam-sealed ceramic package
- REACH/RoHS II Compliant; Pb in glass, exemption 7(c)
- MSL Level 1

Typical Applications

- Computers, Modems, Communication equipment
- Industrial wide temperature applications

Electrical Specifications

Parameters	Min.	Typ.	Max.	Units	Notes
Frequency Range	8.000		48.000	MHz	Fundamental AT-cut
Operating Temperature Range	-10		+60	°C	See options
Storage Temperature Range	-55		+125	°C	
Frequency Tolerance @ +25°C	-50		+50	ppm	See options
Frequency Stability over the Operating Temperature (ref. to +25°C)	-50		+50	ppm	See options
Equivalent series resistance	See table 1 below			Ω	
Shunt capacitance (C0)			7	pF	
Load capacitance (CL)		18		pF	See options
Drive Level		10	100	μW	
Aging@25°C±3°C			±5	ppm	Frist year
Insulation Resistance	500			MΩ	@ 100Vdc
Sealing Method	Glass Sealing				
Spurious			-3	dB	Fo to Fo+5000 ppm

Table 1

Frequency (MHz)	ESR(Ω) max.
8.000-9.999	100
10.000-11.999	80
12.000-15.999	60
16.000-48.000	50

Part Identification

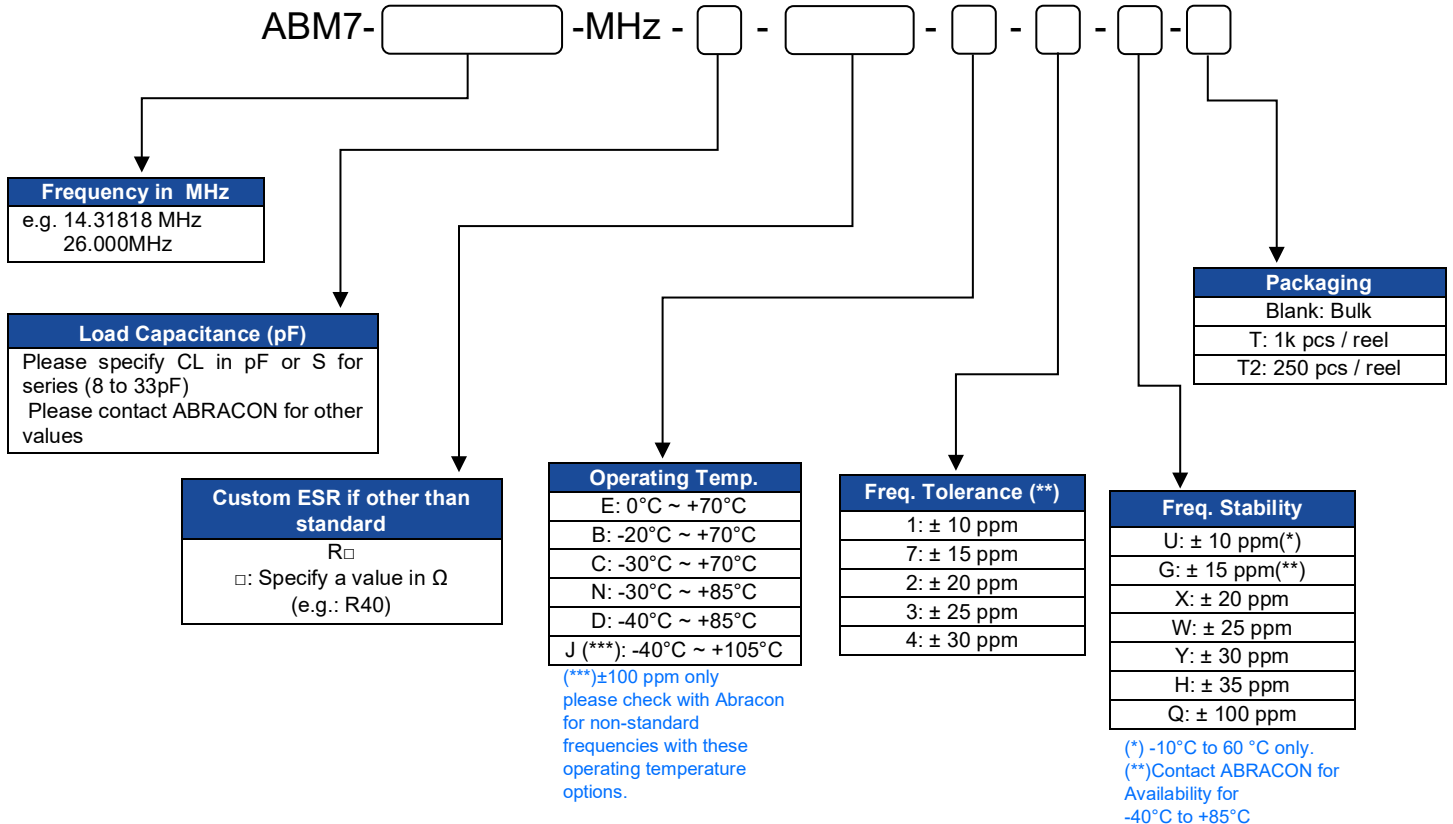

Mechanical Dimensions

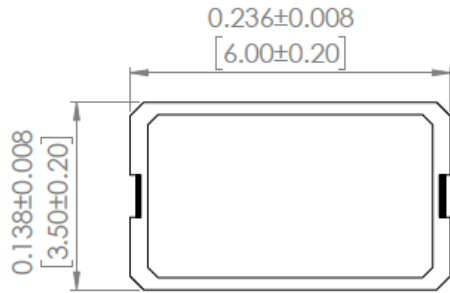

TOP VIEW



SIDE VIEW

CONNECTION

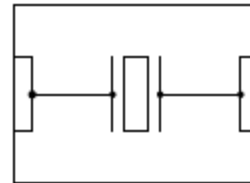

FRONT VIEW

RECOMMENDED LAND PATTERN

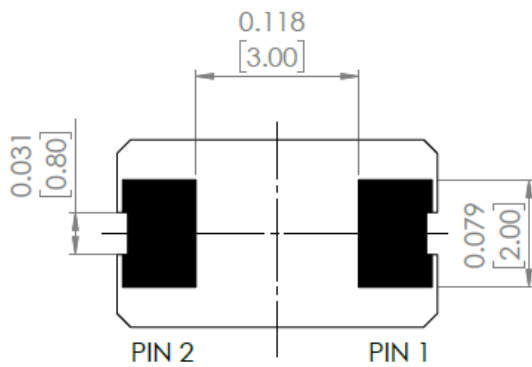
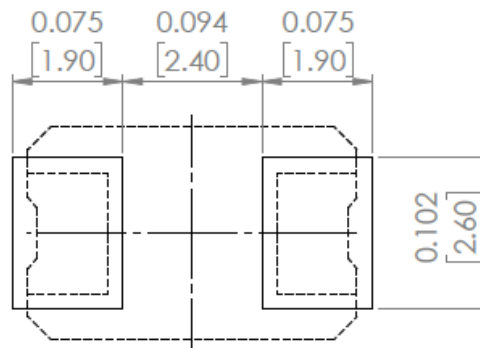

BOTTOM VIEW

Dimensions: inches (mm)

Note: Due to the availability of raw materials, this part may be manufactured with a chamfer on pin 1. Be advised that this does not affect the electrical characteristics of the crystal in any way.

Mechanical Dimensions (Alternate)

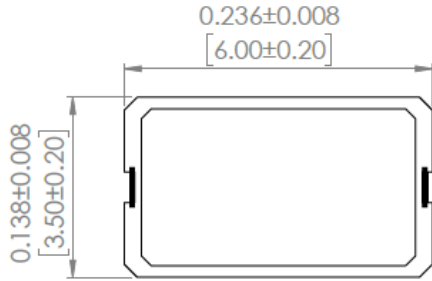

TOP VIEW

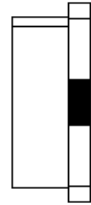

SIDE VIEW

CONNECTION

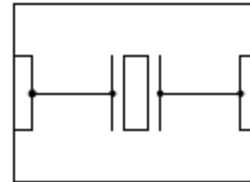

FRONT VIEW

RECOMMENDED LAND PATTERN

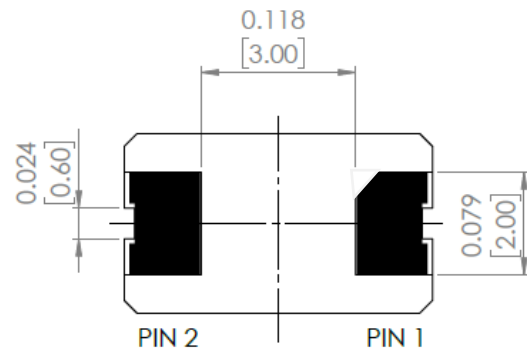
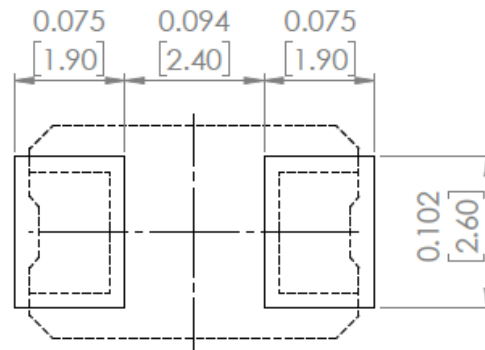

BOTTOM VIEW

Dimensions: inches (mm)

Note: Due to the availability of raw materials, this part may be manufactured with a chamfer on pin 1. Be advised that this does not affect the electrical characteristics of the crystal in any way.

Reflow Profile [JEDEC J-STD-020]

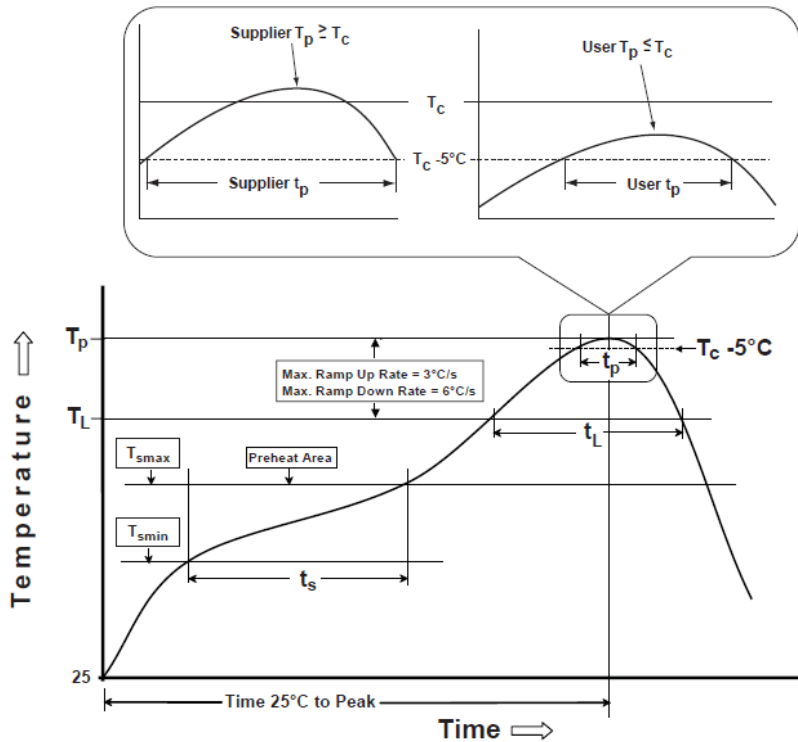

Table 1

SnPb Eutectic Process Classification Temperatures (T_c)		
Package Thickness	Volume mm^3 <350	Volume mm^3 ≥ 350
<2.5 mm	235 °C	220 °C
≥ 2.5 mm	220 °C	220 °C

Table 2

Pb-Free Process Classification Temperatures (T_c)			
Package Thickness	Volume mm^3 <350	Volume mm^3 350-2000	Volume mm^3 >2000
<1.6 mm	260 °C	260 °C	260 °C
1.6 mm - 2.5 mm	260 °C	250 °C	245 °C
>2.5 mm	250 °C	245 °C	245 °C

Profile Feature	Sn-Pb Eutectic Assembly	Pb-Free Assembly
Preheat / soak		
Temperature minimum (T_{smin})	100°C	150°C
Temperature maximum (T_{smax})	150°C	200°C
Time (T_{smin} to T_{smax}) (t_s)	60 - 120 sec.	60 - 120 sec.
Average ramp-up rate (T_{smax} to T_p)	3°C/sec. max	3°C/sec. max
Liquidous temperature (T_L)	183°C	217°C
Time at liquidous (t_L)	60 - 150 sec.	60 - 150 sec.
Peak package body temperature (T_p)*	see Table 1	see Table 2
Time (t_p)** within 5°C of the specified classification temperature (T_c)	20 sec.	30 sec.
Ramp-down rate (T_p to T_{smax})	6°C/sec. max	6°C/sec. max
Time 25°C to peak temperature	6 min. max	8 min. max
Reflow cycles	2 max	2 max

*Tolerance for peak profile temperature (T_p) is defined as a supplier minimum and a user maximum.

**Tolerance for time at peak profile temperature (t_p) is defined as supplier minimum and a user maximum.

Packaging

T: 1,000pcs/reel

T2: 250pcs/reel

