



Inclination sensor INY360D-F99-B16-V15

- E1-Type approval
- Measuring range 0 ... 360°
- High shock resistance
- Extended temperature range
-40 ... +85 °C
- CANopen interface
- Increased noise immunity 100 V/m

CANopen



Dimensions

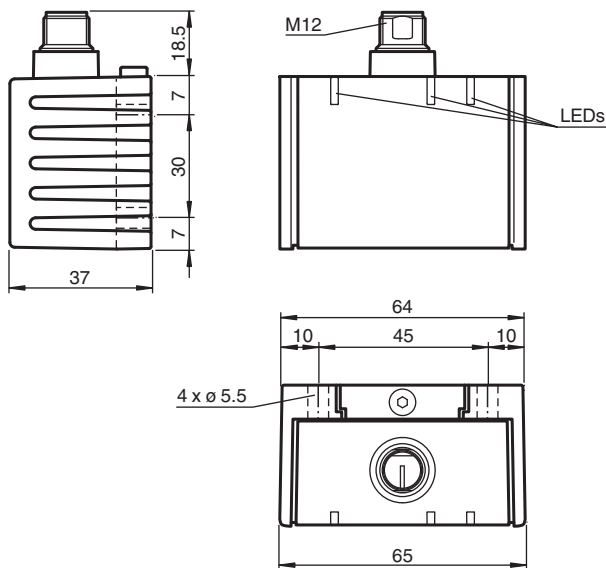

Technical Data

General specifications

Type	Inclination sensor, 2-axis
Measurement range	0 ... 360 °
Absolute accuracy	≤ ± 0.5 °
Response delay	≤ 25 ms
Resolution	≤ 0.1 °
Repeat accuracy	≤ ± 0.1 °
Temperature influence	≤ 0.027 °/K

Functional safety related parameters

Release date: 2020-06-22 Date of issue: 2020-06-22 Filename: 212421_eng.pdf

Refer to "General Notes Relating to Pepperl+Fuchs Product Information".

Pepperl+Fuchs Group
www.pepperl-fuchs.com

USA: +1 330 486 0001
fa-info@us.pepperl-fuchs.com

Germany: +49 621 776 1111
fa-info@de.pepperl-fuchs.com

Singapore: +65 6779 9091
fa-info@sg.pepperl-fuchs.com

PF PEPPERL+FUCHS

Technical Data

MTTF _d		300 a
Mission Time (T _M)		20 a
Diagnostic Coverage (DC)		0 %
Indicators/operating means		
Operation indicator		LED, green
Electrical specifications		
Operating voltage	U _B	10 ... 30 V DC
No-load supply current	I ₀	≤ 50 mA
Time delay before availability	t _v	≤ 2.5 s
Interface		
Interface type		CANopen
Device profile		CiA410, Ver. 1.2
Data output code		binary code
Node ID		1 ... 127 , programmable
Transfer rate		125 kBit/s , 250 kBit/s , 500 kBit/s , 1 MBit/s , programmable
Termination		external
Cycle time		≥ 20 ms
Compliance with standards and directives		
Standard conformity		
Shock and impact resistance		100 g according to DIN EN 60068-2-27
Standards		EN 60947-5-2:2007 IEC 60947-5-2:2007
Approvals and certificates		
UL approval		cULus Listed, Class 2 Power Source
E1 Type approval		10R-04
Ambient conditions		
Ambient temperature		-40 ... 85 °C (-40 ... 185 °F)
Storage temperature		-40 ... 85 °C (-40 ... 185 °F)
Mechanical specifications		
Connection type		5-pin, M12 x 1 connector
Housing material		PA
Degree of protection		IP68 / IP69K
Mass		240 g
Factory settings		
Node ID		1
Transfer rate		250 kBit/s

Connection

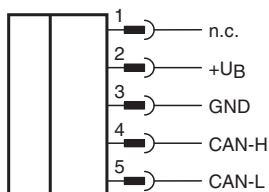

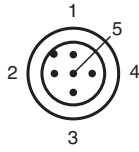

Connection Assignment



Wire colors in accordance with EN 60947-5-2

1	BN	(brown)
2	WH	(white)
3	BU	(blue)
4	BK	(black)
5	GY	(gray)

Accessories

	V15S-T-CAN/DN-V15	Y-Splitter, M12 socket on M12 connector/socket
	ICZ-TR-CAN/DN-V15	Terminal resistor for DeviceNet, CANopen

Release date: 2020-06-22 Date of issue: 2020-06-22 Filename: 212421_eng.pdf

Refer to "General Notes Relating to Pepperl+Fuchs Product Information".

Mounting

Sensor Orientation

In the default setting the zero position of the sensor is reached, when the electrical connection faces straight upwards.

X Orientation

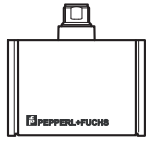

X = 0°

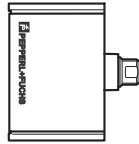

X = 90°

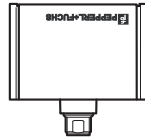

X = ±180°

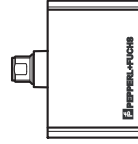

X = 270° (-90°)

Y Orientation



Y = 0°

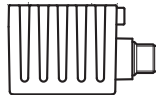

Y = 90°



Y = ±180°

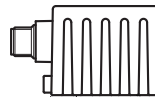

Y = 270° (-90°)

Mounting of the sensor

Sensors from the -F99 series consist of a sensor module and accompanying cast aluminum housing. Select a vertical surface with minimum dimensions of 70 mm x 50 mm to mount the sensor.

Mount the sensor as follows:

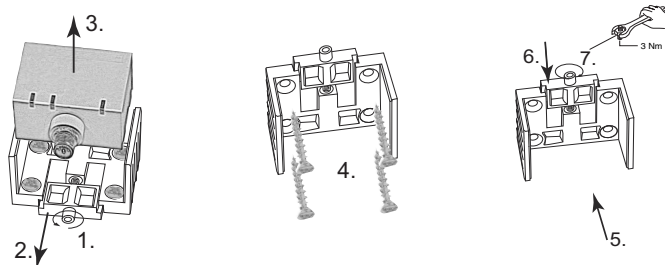

1. Loosen the central screw under the sensor connection.
2. Slide back the clamping element until you are able to remove the sensor module from the housing.
3. Remove the sensor module from the housing
4. Position the housing at the required mounting location and secure using four countersunk screws. Make sure that the heads of the screws do not protrude.
5. Place the sensor module in the housing.
6. Slide the clamping element flush into the housing. Check that the sensor element is seated correctly.
7. Finally tighten the central screw.

The sensor is now mounted correctly.

Configuration

Baud rate setting

Inclination sensors by Pepperl+Fuchs are supplied with a baud rate of 250 kbit/s. To change the baud rate, write the new baud rate to object 2001h "Baud rate." If a "Reset sensor" command is issued via an NMT message or the power supply is interrupted, the sensor operates at the new baud rate. The inclination sensor supports the baud rates 125 kbit/s, 250 kbit/s, 500 kbit/s and 1 Mbit/s. Invalid values are not adopted. In this case, the current setting is retained.

Example of modifying the baud rate from 250 kbit/s to 1 Mbit/s:

601h	2Fh	01h	20h	00h	08h	xxh	xxh	xxh
CAN-ID	Command	Object index		Subindex	New baud rate	not used		
	Data byte 1	Data byte 2	Data byte 3	Data byte 4	Data byte 5	Data byte 6	Data byte 7	Data byte 8

CAN ID: 601h, SDO1 channel of node 1

Command: 2Fh, write object, 1 byte of usable data

Object index: 201h, note: low byte first, then high byte!

Subindex: 00h

New baud rate: 08h, for 1 Mbit/s

New baud rate: 04h, for 500 kbit/s

New baud rate: 02h, for 250 kbit/s

New baud rate: 01h, for 125 kbit/s

Indication

LED displays

The inclination sensor has three indicator LEDs that allow rapid visual monitoring.

- The green **power** LED indicates the state of the power supply
- The yellow **run** LED indicates the bus and sensor status
- The red **err** LED indicates an error

power (green)	run (yellow)	err (red)	Meaning
Off	Off	Off	No power supply
On	Flashing constantly	Off	Pre-operational
On	1x flashing	Off	Stopped
On	On	Off	Operational
On	Off	On	CAN bus off
On	depending on bus status	1x flashing	Warning, e.g., outside measuring range
On	depending on bus status	2x flashing	Error, e.g., EEPROM checksum incorrect
Flashing constantly	Off	On	Undervoltage

Technical Features

EMC Properties

Interference immunity in accordance with

DIN ISO 11452-2: 100 V/m

Frequency band 20 MHz up to 2 GHz

Mains-borne interference in accordance with ISO 7637-2:

Pulse	1	2	2	3	3	4
		a	b	a	b	
Severity level	I	I	I	I	I	I
	I	I	I	I	I	I
	I	I	I	I	I	I
Failure criterion	C	A	C	A	A	C
EN 61000-4-2:	CD: 8 kV		AD: 15 kV			
	/					
Severity level	IV		IV			
EN 61000-4-3:	30 V/m (80...2500 MHz)					
Severity level	IV					
EN 61000-4-4:	2 kV					
Severity level	III					
EN 61000-4-6:	10 V (0.01...80 MHz)					
Severity level	III					
EN 55011:	Klasse A					

Release date: 2020-06-22 Date of issue: 2020-06-22 Filename: 212421_eng.pdf