

Read/write station

IPT1-FP

- With integrated control interface unit
- Serial interfaces and field-bus interfaces selectable through lower part
- Read distance of up to 100 mm
- Write distance of up to 50 mm
- 3 LEDs for function indication
- Degree of protection IP67
- Optimized reading speed for fixed codes
- Suited for writing of IPC11

LF R/W system, fully assembled as configuration and test station



Function

The IPT1-FP read/write station is used in combination with a base which contains the interface for connecting to a computer. Through the choice of base, either serial interfaces or field-bus interfaces may be selected. The analysis system is integrated in the device and simplifies the system construction. Protection class IP67 allows the device to be installed directly in the field.

Dimensions

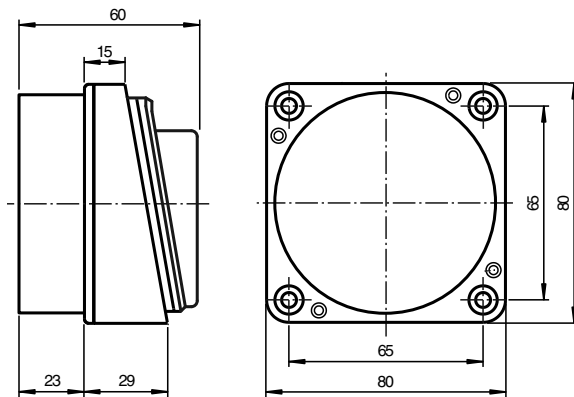

Technical Data

General specifications

Operating frequency	125 kHz
Transfer rate	2 kBit/s
Operating distance	maximum: 100 mm
UL File Number	E87056

Release date: 2022-12-15 Date of issue: 2022-12-15 Filename: 183956_eng.pdf

Refer to "General Notes Relating to Pepperl+Fuchs Product Information".

Pepperl+Fuchs Group
www.pepperl-fuchs.com

USA: +1 330 486 0001
fa-info@us.pepperl-fuchs.com

Germany: +49 621 776 1111
fa-info@de.pepperl-fuchs.com









Singapore: +65 6779 9091
fa-info@sg.pepperl-fuchs.com

 PEPPERL+FUCHS

Technical Data

Indicators/operating means		
LED green		Power on
LED yellow		IPC detected
LED red		bus fault (when using fieldbus interfaces)
Electrical specifications		
Rated operating voltage	U_e	20 ... 30 V DC , ripple 10 % _{SS} , PELV
Power consumption	P_0	max. 5 W , in connection with the base
Galvanic isolation		
Operating voltage/interface		functional insulation acc. to DIN EN 50178, rated insulation voltage 50 V _{eff}
Mag. Field strength		< 27.3 dB μ A/m at 10 m
Interface		
Physical		Interface type depends on base used
Directive conformity		
Radio equipment		
Directive 2014/53/EU		EN 301489-1 EN 300330 EN 62368-1
RoHS		
Directive 2011/65/EU (RoHS)		IEC/EN 63000
Standard conformity		
RFID		ISO/IEC 18000-2
Ambient conditions		
Ambient temperature		-25 ... 70 °C (-13 ... 158 °F)
Storage temperature		-40 ... 85 °C (-40 ... 185 °F)
Mechanical specifications		
Degree of protection		IP67 according to EN 60529, with base
Material		
Housing		PBT

Matching System Components

	U-P3-RX	Base with serial interfaces RS 232 and RS 485
	U-P3-R4	Base with addressable serial Interface RS 485
	U-P3-R4-V15	Base with addressable serial Interface RS 485
	U-P6-B5	Base for INTERBUS
	U-P6-B5-V	Base for INTERBUS, plug-in connection
	U-P6-B6	Base for PROFIBUS DP
	U-P6-B6-V15B	Base for PROFIBUS DP, plug-in connection
	U-P6V4A-B6	Base for PROFIBUS DP, stainless steel version
	U-P3V4A-RX	Base with serial interfaces RS 232 and RS 485, stainless steel version V4A

Release date: 2022-12-15 Date of issue: 2022-12-15 Filename: 183956_eng.pdf

Refer to "General Notes Relating to Pepperl+Fuchs Product Information".

Pepperl+Fuchs Group
www.pepperl-fuchs.comUSA: +1 330 486 0001
fa-info@us.pepperl-fuchs.comGermany: +49 621 776 1111
fa-info@de.pepperl-fuchs.comSingapore: +65 6779 9091
fa-info@sg.pepperl-fuchs.com

PEPPERL+FUCHS