

General Specifications

B Electrical Capacity (Resistive Load)

Power Level (silver):	Maximum rating varies by model number MN12, MN22: 6A @ 125V AC, 3A @ 250V AC, 4A @ 30V DC MN13, MN15, MN18, MN19, MN23, MN25: 6A @ 125V AC, 3A @ 250V AC, 3A @ 30V DC MN28, MN29: 4A @ 125V AC, 3A @ 250V AC, 3A @ 30V DC MN24, MN26, MN27: 3A @ 125V AC, 2A @ 250V AC, 2A @ 30V DC MN32: 4A @ 125V AC, 2A @ 250V AC, 3A @ 30V DC MN33, MN35, MN38, MN39: 4A @ 125V, 2A @ 250V, 2A @ 30V Recommended minimum voltage/current: 0.1A @ 2V AC/DC 4A @ 30V DC for On-None-On; 3A @ 30V DC for all other circuits
Logic Level (gold):	0.4VA maximum @ 28V AC/DC maximum (Applicable Range 0.1mA ~ 0.1A @ 20mV ~ 28V)

Other Ratings

Contact Resistance:	10 milliohms maximum for silver; 20 milliohms maximum for gold
Insulation Resistance:	1,000 megohms minimum @ 500V DC
Dielectric Strength:	1,000V AC minimum between contacts for 1 minute minimum; 1,500V AC minimum between contacts and case for 1 minute minimum
Mechanical Life:	50,000 operations minimum
Electrical Life:	25,000 operations minimum for silver; 50,000 operations minimum for gold
Angle of Throw:	25°

Materials & Finishes

Actuator Clip & Mounting Frame:	Stainless steel or beryllium copper for spring
Body Frame:	Stainless steel
Case:	Diallyl phthalate resin (UL94V-0)
Movable Contacts:	Silver alloy (code W); copper with gold plating (code G)
Stationary Contacts:	Silver with silver plating (code W); copper or brass with gold plating (code G)
Terminals:	Copper or brass with silver plating; or copper or brass with gold plating

Environmental Data

Operating Temp Range:	-30°C through +85°C (-22°F through +185°F)
Humidity:	90 ~ 95% humidity for 240 hours @ 40°C (104°F)
Vibration:	10 ~ 55Hz with peak-to-peak amplitude of 1.5mm traversing the frequency range & returning in 1 minute; 3 right angled directions for 2 hours
Shock:	500m/s ² acceleration (tested in 6 right angled directions, with 5 shocks in each direction)

Processing

Soldering:	Wave Soldering (PC version) for Gold: See Profile A in Supplement section. Manual Soldering for Gold: See Profile A in Supplement section. Wave Soldering (PC version) for Silver: See Profile B in Supplement section. Manual Soldering for Silver: See Profile B in Supplement section. Note: Actuator must be in OFF (center) position while soldering.
Cleaning:	These devices are not process sealed. Hand clean locally using alcohol based solution.

Standards & Certifications

Flammability Standards:	UL94V-0 for case
UL:	Contact NKK Switches for UL or CUL marking option requirements.

Distinctive Characteristics

Three methods of panel mounting: flat frame for flush with face or subpanel, snap-in, and PCB.

High insulating barriers increase isolation of circuits in multipole devices and provide added protection to contact points.

The molded diallyl phthalate case has a UL94V-0 flammability rating.

Epoxy sealed terminals prevent entry of solder flux and other contaminants.

Prominent external insulating barriers increase insulation resistance and dielectric strength.

Bias guard prevents misalignment of contacts; interlocking of actuator block with rocker and internal guide does not allow transmission of diagonal force on rocker to reach contact mechanism.

Clinching of the frame to the case well above the base and terminals provides 1,500V dielectric strength.

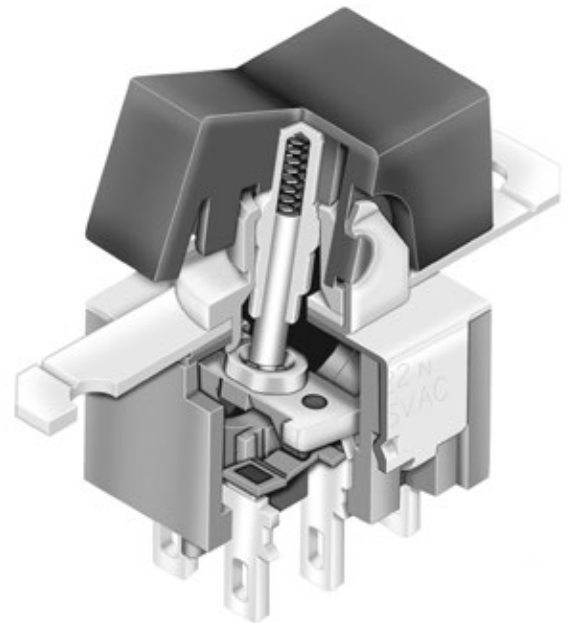

Actual Size

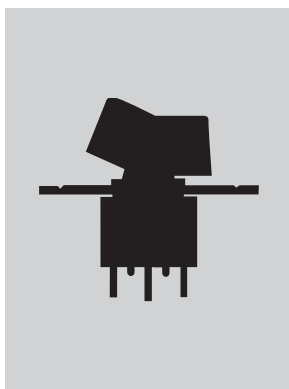

- Toggles
- B** Rockers
- Pushbuttons
- Illuminated PB
- Programmable
- Keylocks
- Rotaries
- Slides
- Tactiles
- Tilt
- Touch
- Indicators
- Accessories
- Supplement

TYPICAL SWITCH

Toggles

Rockers **B**

Pushbuttons

Illuminated PB

Programmable PB

Keylocks

Rotaries

Slides

Tactiles

Tilt

Touch

Indicators

Accessories

Supplement

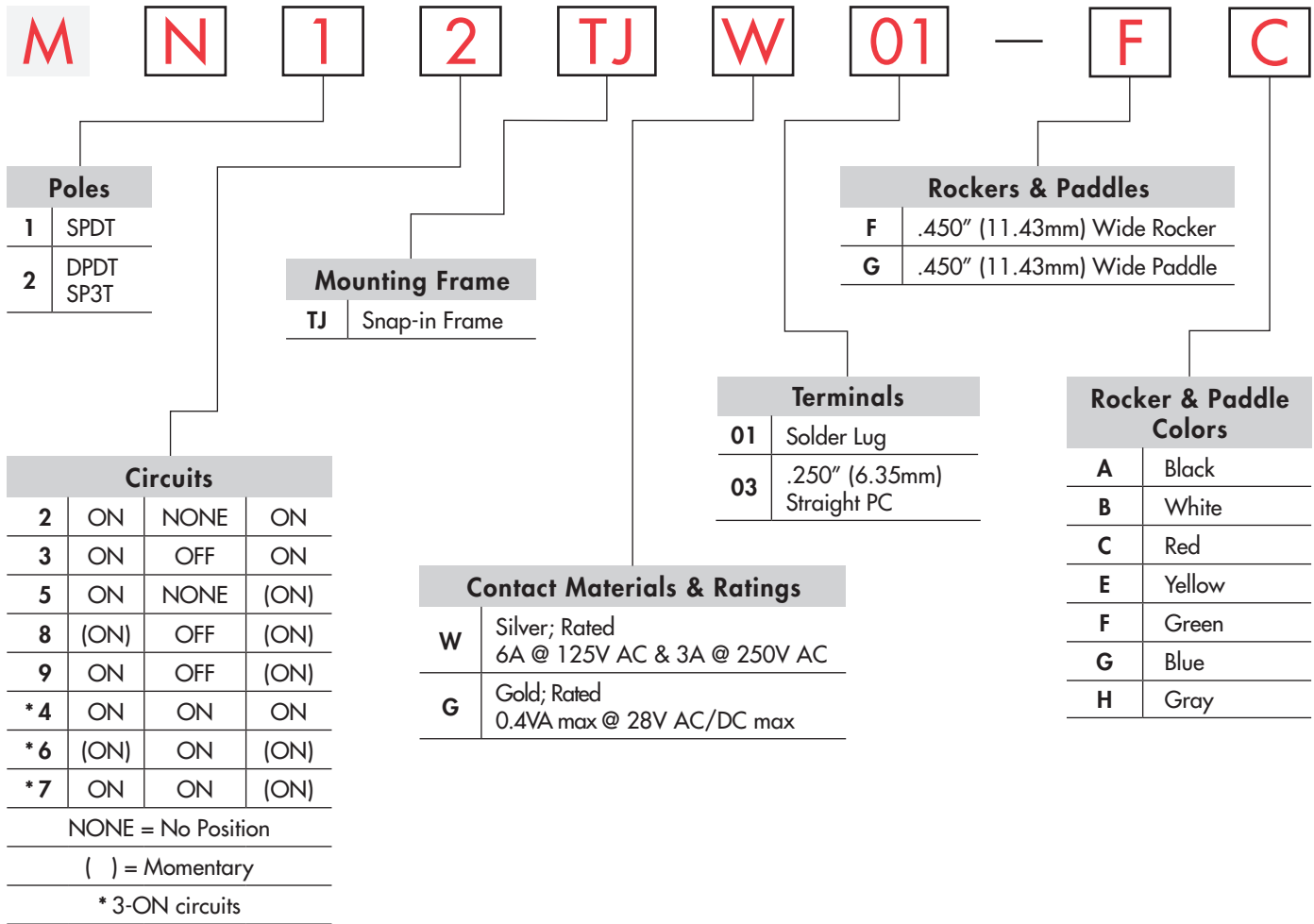

DESCRIPTION FOR TYPICAL ORDERING EXAMPLE

MN12TJW01-FC-1A

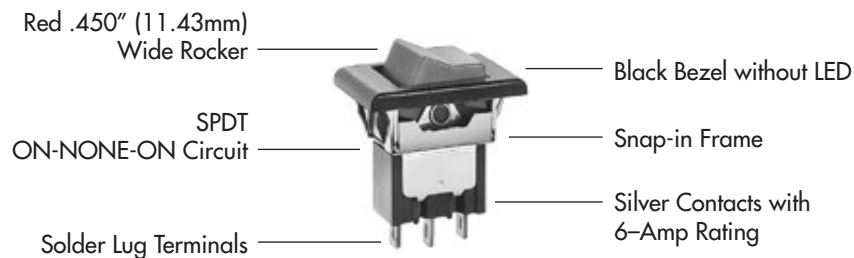

ORDERING EXAMPLE

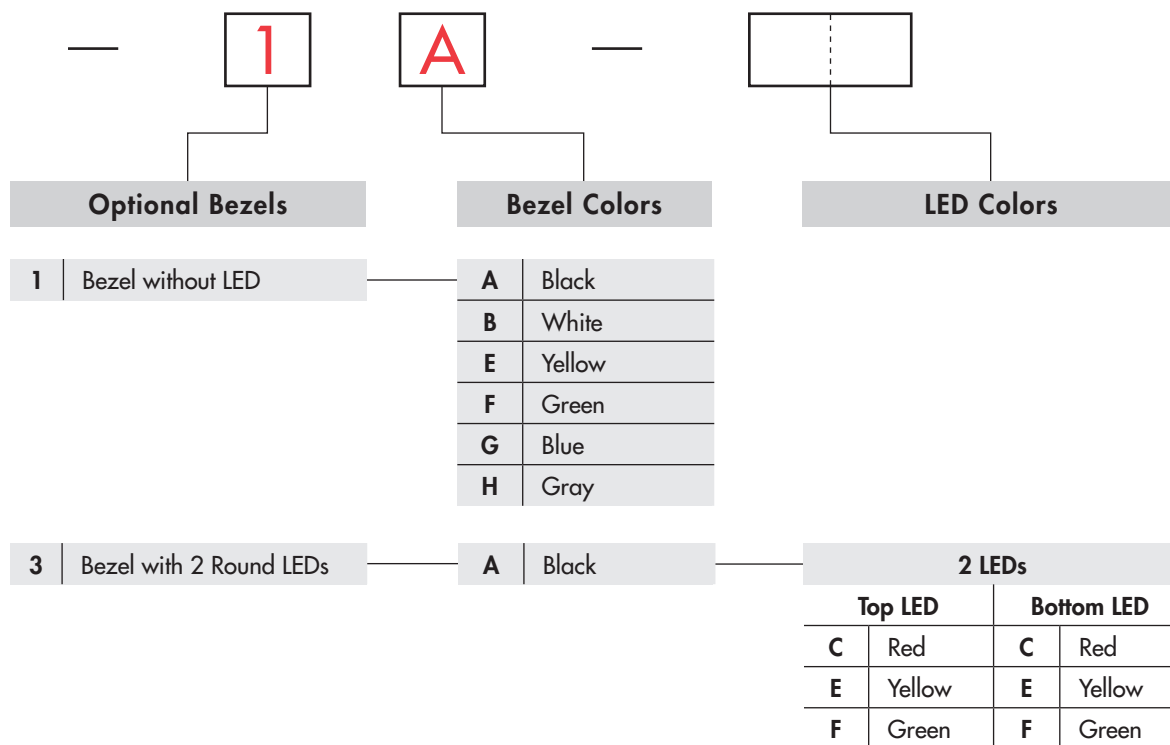

DESCRIPTION FOR TYPICAL ORDERING EXAMPLE

MN12TJW01-FC-3A-CF

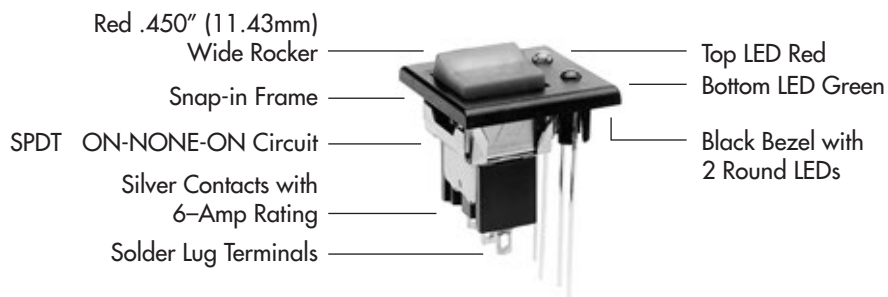

Toggle

Rockers **B**

Pushbuttons

Programmable Illuminated PB

Keylocks

Rotaries

Slides

Tactiles

Tilt

Touch

Indicators

Accessories

Supplement

POLES & CIRCUITS

Pole	Model	Rocker Position			Connected Terminals			Throw & Schematics
		Down	Center	Up	Down	Center	Up	
		NONE = No Position () = Momentary						
								Note: Terminal numbers are not actually on the switch.
SP	MN12 MN13 MN15 MN18 MN19	ON ON ON (ON) ON	NONE OFF NONE OFF OFF	ON ON (ON) (ON) (ON)	2-3	OPEN	2-1	SPDT
DP	MN22 MN23 MN25 MN28 MN29	ON ON ON (ON) ON	NONE OFF NONE OFF OFF	ON ON (ON) (ON) (ON)	2-3 5-6	OPEN	2-1 5-4	DPDT

For 3 Throw (3-On)

Pole	Model	Connected Terminals & Schematic			External Connection
		Down	Center	Up	
SP	MN24 MN26 MN27	ON (ON) ON 2-3 5-6	ON ON ON 2-3 5-4	ON (ON) (ON) 2-1 5-4	<p>The SP3T model utilizes a double pole base.</p> <p>External connection must be made during field installation.</p>

MOUNTING FRAME

TJ

Snap-in Frame

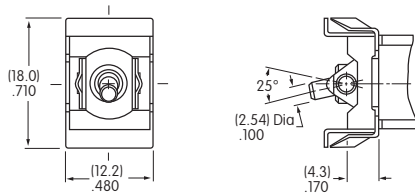

Panel Cutout for Single Pole without Bezel

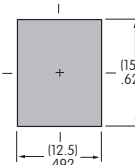

Panel Cutout for Double Pole without Bezel

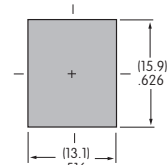

Panel Thickness without Bezel: .039" ~ .126" (1.0mm ~ 3.2mm)
Panel Thickness with Bezel: .039" ~ .098" (1.0mm ~ 2.5mm)

CONTACT MATERIALS & RATINGS

W

Silver Power Level

MN12, MN22: 6A @ 125V AC, 3A @ 250V AC, 4A @ 30V DC
MN13, MN15, MN18, MN19, MN23, MN25: 6A @ 125V AC, 3A @ 250V AC, 3A @ 30V DC
MN28, MN29: 4A @ 125V AC, 3A @ 250V AC, 3A @ 30V DC
MN24, MN26, MN27: 3A @ 125V AC, 2A @ 250V AC, 2A @ 30V DC

G

Gold

Logic Level

0.4VA maximum @ 28V AC/DC maximum

Note: Complete explanation of operating range in Supplement section.

Gold over Silver

Power Level or Logic Level

See above for each rating

Note: Gold over silver is available as a custom option. This dual rated option is suitable when two or more identical switches are used in logic and in power circuits within the same application. See Supplement section to find complete explanation of dual rating and operating range.

TERMINALS

01 Solder Lug

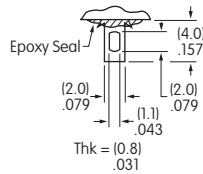

03 .250" (6.35mm) Straight PC

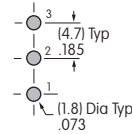
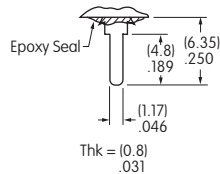

Single Pole

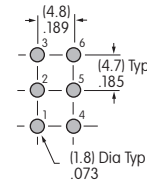

Double Pole

ROCKERS & PADDLES

F AT4150
.450" (11.43mm)
Wide Rocker

Material: Polyamide
Finish: Matte

Colors Available:
A, B, C, E, F, G, H

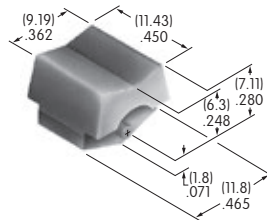

G AT4151
.450" (11.43mm)
Wide Paddle

Material: Polyamide
Finish: Matte

Colors Available:
A, B, C, E, F, G, H

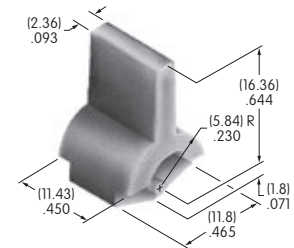

Cap Colors Available:



Black



White



Red



Yellow



Green



Blue



Gray

OPTIONAL SNAP-IN BEZELS & BEZEL COLORS

1 AT2107 Bezel

Material:
Polyamide

Finish:
Matte

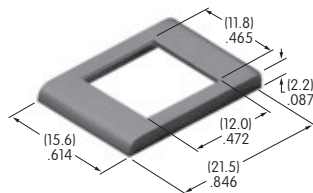

Black



Green



White



Blue



Yellow



Gray

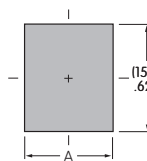

	Single Pole	Double Pole
A	(12.5)mm .492"	(13.1)mm .516"

3 AT212 Bezel
for AT617 LED

Material:
Polycarbonate

Finish:
Semi-glossy

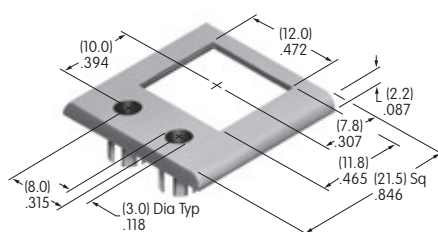

Black

LED colors and specifications are on the following page.

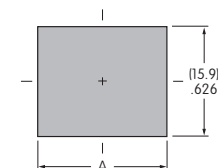

	Single Pole	Double Pole
A	(18.4)mm .724"	(18.7)mm .736"

Bezel Assembly

1. Pry out tab on bezel to a 45° angle.
2. Insert switch frame under tab and snap on bezel.
3. Push tab back into place.
4. Snap assembled bezel and switch into panel.

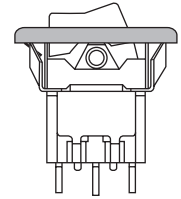
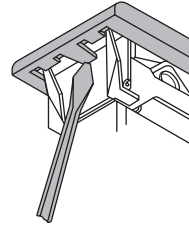
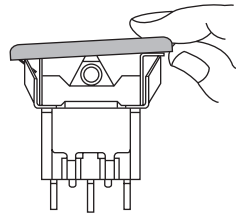
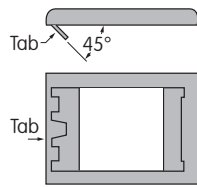

LED COLORS & SPECIFICATIONS

AT617 LED

For Bezel AT212
with 2 Round LEDs

Note: Lead lengths may differ from manufacturing lot to lot. The longer lead is the anode (+).

Bezel Orientation on Switch

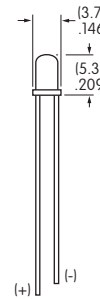
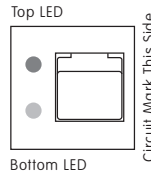

AT617 LED



Color

C Red

E Yellow

F Green

	Color	C Red	E Yellow	F Green
Maximum Forward Current	I_{FM}	30mA	30mA	30mA
Typical Forward Current	I_F	20mA	20mA	20mA
Forward Voltage	V_F	2.1V	2.1V	2.2V
Maximum Reverse Voltage	V_{RM}	5V	5V	5V
Current Reduction Rate Above 25°C	ΔI_F	0.40mA/°C	0.40mA/°C	0.40mA/°C
Ambient Temperature Range (when used with a bezel)		-15° ~ +70°C		

The electrical specifications shown are determined at a basic temperature of 25°C.
The LED circuit is independent of switch operation. LED is colored in OFF state.

If the source voltage is greater than the rated voltage of the LED, a ballast resistor must be connected in series with the lamp. The ballast resistor calculation and more lamp detail are shown in the Supplement section.

LEGENDS

NKK Switches can provide custom legends for caps. Contact factory for more information.

Suggested Printable Area for Cap

Recommended Print Method:

Pad Print

Epoxy based ink is recommended.



AT4150

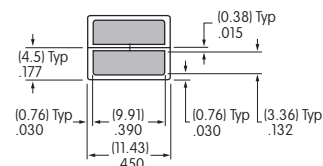

Shaded areas are printable areas.

TYPICAL SWITCH DIMENSIONS

Single Pole

Snap-in Frame • Solder Lug

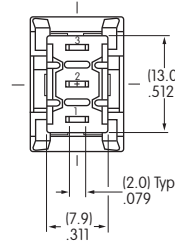
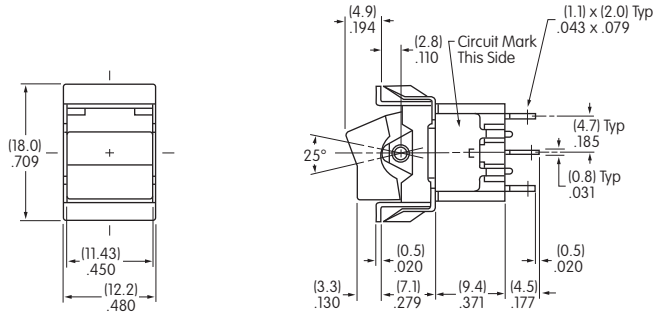

MN12TJW01-FC

Double Pole

Snap-in Frame • Solder Lug

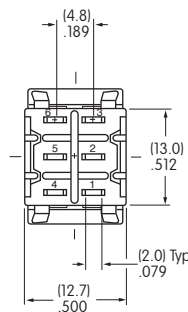
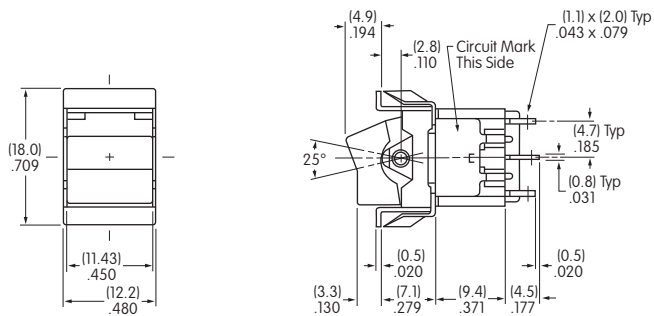

MN22TJW01-FC

Single Pole

Snap-in Frame • Solder Lug

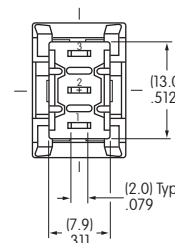
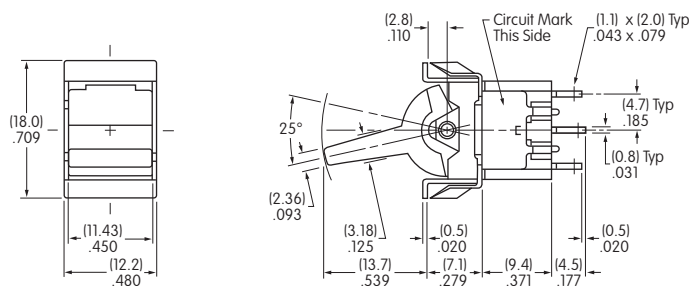

MN12TJW01-GC

Toggles

Rockers **B**

Pushbuttons

Illuminated PB

Programmable

Keylocks

Rotaries

Slides

Tactiles

Tilt

Touch

Indicators

Accessories

Supplement

TYPICAL SWITCH DIMENSIONS

Snap-in Frame • Solder Lug

Double Pole

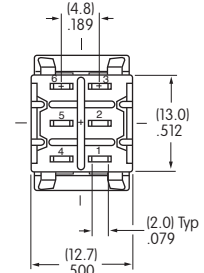
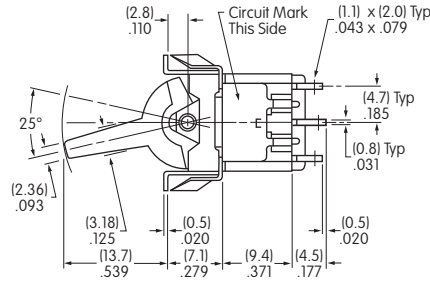
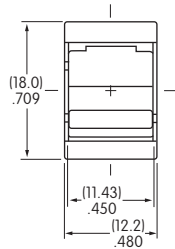

MN22TJW01-GC

Snap-in Frame • AT2107 Bezel • Solder Lug

Single & Double Pole

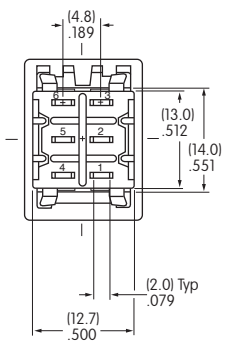
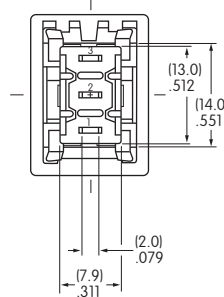
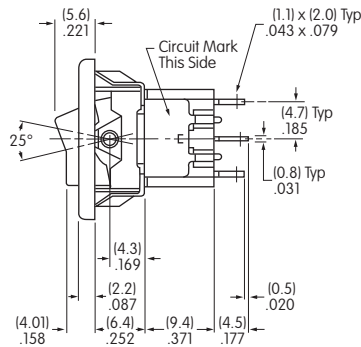
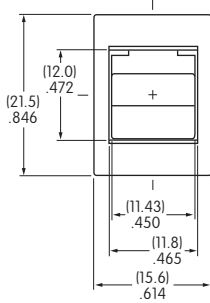

MN12TJW01-FC-1A

Snap-in Frame • AT212 Bezel • Solder Lug

Single Pole

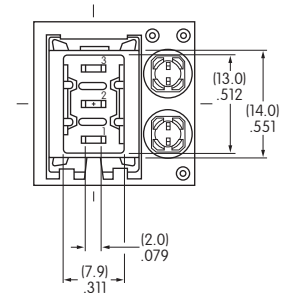
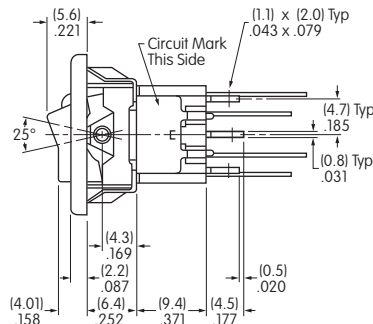
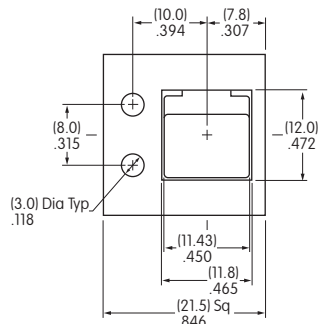

MN12TJW01-FC-3A-CF

TYPICAL SWITCH

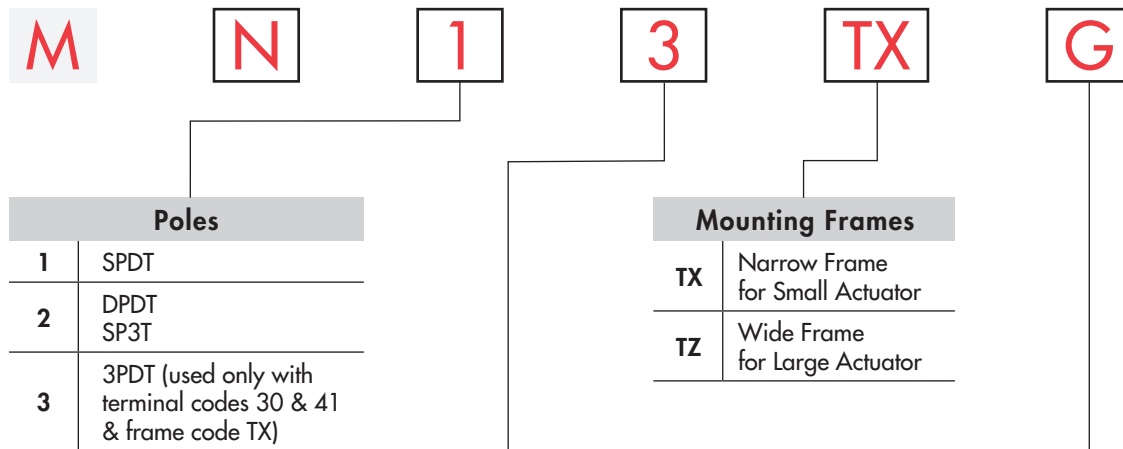

Poles	
1	SPDT
2	DPDT SP3T
3	3PDT (used only with terminal codes 30 & 41 & frame code TX)

Mounting Frames	
TX	Narrow Frame for Small Actuator
TZ	Wide Frame for Large Actuator

Circuits			
2	ON	NONE	ON
3	ON	OFF	ON
5	ON	NONE	(ON)
8	(ON)	OFF	(ON)
9	ON	OFF	(ON)
*4	ON	ON	ON

NONE = No Position
() = Momentary
*3-ON circuits

Contact Materials & Ratings	
W	Silver; Rated 6A @ 125V AC & 3A @ 250V AC
G	Gold; Rated 0.4VA max @ 28V AC/DC max

DESCRIPTION FOR TYPICAL ORDERING EXAMPLE

MN13TXG41-DC

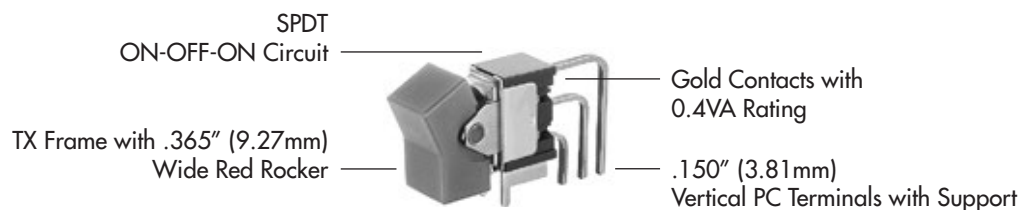

ORDERING EXAMPLE

41

Terminals For TX & TZ Frames

Straight PC with Bracket (1-2 Pole only)

13	.250" (6.35mm) Straight PC with .465" (11.8mm) Bracket
-----------	--

Terminals For TX Frame Only

Right Angle PC with Support (1-3 Pole only)

30	.150" (3.81mm) Right Angle PC
-----------	-------------------------------

Vertical PC with Support (1-3 Pole)

41	.150" (3.81mm) Vertical PC
-----------	----------------------------

D

C

Rockers & Paddles

Small Actuators (TX Frame)

D	.365" (9.27mm) Wide Rocker
E	.365" (9.27mm) Wide Paddle
F	.450" (11.43mm) Wide Rocker
G	.450" (11.43mm) Wide Paddle

Large Actuators (TZ Frame)

J	.595" (15.11mm) Wide Rocker
H	.595" (15.11mm) Wide Paddle

Rocker & Paddle Colors

A	Black
B	White
C	Red
E	Yellow
F	Green
G	Blue
H	Gray

- Supplement
- Accessories
- Indicators
- Touch
- Tilt
- Tactiles
- Slides
- Rotaries
- Keylocks
- Programmable
- Illuminated PB
- Pushbuttons
- Rockers
- Toggles

B

Toggle

Rockers **B**

Pushbuttons

Illuminated PB

Programmable

Keylocks

Rotaries

Slides

Tactiles

Tilt

Touch

Indicators

Accessories

POLES & CIRCUITS

Pole	Model	Rocker Position			Connected Terminals			Throw & Schematics
		Down	Center	Up	Down	Center	Up	
		NONE = No Position () =Momentary						
								Note: Terminal numbers are not actually on the switch. * Reverse circuits available for vertical mount SP & DP upon request.
SP	MN12 MN13 *MN15 MN18 *MN19	ON ON ON (ON) ON	NONE OFF NONE OFF OFF	ON ON (ON) (ON) (ON)	2-3	OPEN	2-1	SPDT
DP	MN22 MN23 *MN25 MN28 *MN29	ON ON ON (ON) ON	NONE OFF NONE OFF OFF	ON ON (ON) (ON) (ON)	2-3 5-6	OPEN	2-1 5-4	DPDT
3P	MN32 MN33 *MN35 MN38 *MN39	ON ON ON (ON) ON	NONE OFF NONE OFF OFF	ON ON (ON) (ON) (ON)	2-3 5-6 8-9	OPEN	2-1 5-4 8-7	3PDT

For 3 Throw (3-On)

Connected Terminals & Schematics

Pole	Model	Down	Center	Up	Down	Center	Up
SP	MN24 MN26 MN27	ON (ON) ON	ON ON ON	ON (ON) (ON)	 2-3 5-6	 2-3 5-4	 2-1 5-4

The SP3T model utilizes a double pole base.

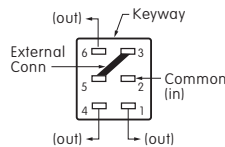

External connection must be made during field installation.

MOUNTING FRAMES

TX Narrow Mounting Frame for Small Actuators with Straight PC Terminals (codes 13, 15, 17, 23, 25, & 26) or with Angle PC Terminals (codes 30 & 41)

Straight PC Mounting

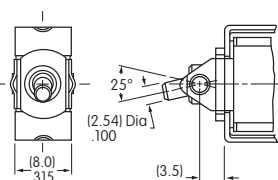

Right Angle PC Mounting

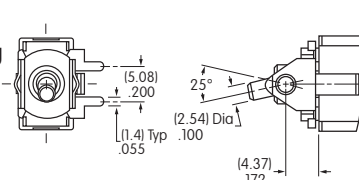

Vertical PC Mounting

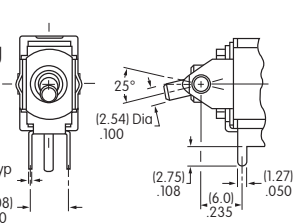

Small Actuators & Panel Cutouts for TX Frame (actuator details on the following pages)

AT4148

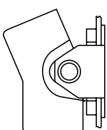

AT4149

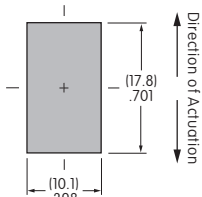
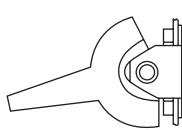

AT4150

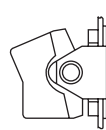

AT4151

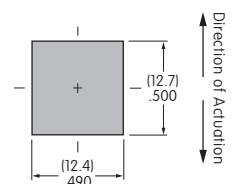
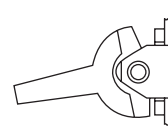

MOUNTING FRAMES

TZ Wide Mounting Frame for Large Actuators with Straight PC Terminals (codes 13, 15, 17, 23, 25, & 26)

Large Actuators & Panel Cutouts for TZ Frame (actuator details on the following pages)

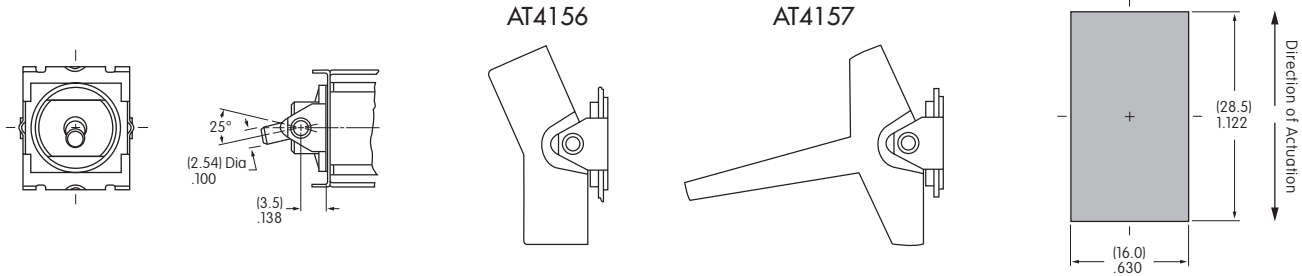

CONTACT MATERIALS & RATINGS

W Silver Power Level

- MN12, MN22: 6A @ 125V AC, 3A @ 250V AC, 4A @ 30V DC
- MN13, MN15, MN18, MN19: 6A @ 125V AC, 3A @ 250V AC, 3A @ 30V DC
- MN23, MN25: 6A @ 125V AC, 3A @ 250V AC, 3A @ 30V DC
- MN28, MN29: 4A @ 125V AC, 3A @ 250V AC, 3A @ 30V DC
- MN24: 3A @ 125V AC, 2A @ 250V AC, 2A @ 30V DC
- MN32: 4A @ 125V AC, 2A @ 250V AC, 3A @ 30V DC
- MN33, MN35, MN38, MN39: 4A @ 125V AC, 2A @ 250V AC, 2A @ 30V AC

G Gold

Logic Level

0.4VA maximum @ 28V AC/DC maximum

Note: Complete explanation of operating range in Supplement section.

Gold over Silver

Power Level or Logic Level

See above for ratings

Note: Gold over silver is available as a custom option. This dual rated option is suitable when two or more identical switches are used in logic and in power circuits within the same application. See Supplement section to find complete explanation of dual rating and operating range.

TERMINALS

For TX and TZ 1-2 Pole Straight PC Mount with Bracket

13 .250" (6.35mm) Terminal with .465" (11.8mm) Bracket

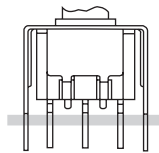

PCB footprints are on the following Typical Switch Dimension pages.

For TX 1-3 Pole Right Angle PC Mount

30 .150" (3.81mm) Right Angle PC

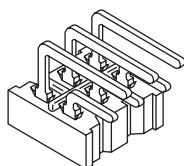

For TX 1-4 Pole Vertical PC Mount

41 .150" (3.81mm) Vertical PC

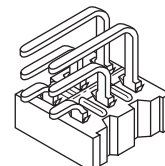

Toggles
Rockers
Pushbuttons
Illuminated PB
Programmable
Keylocks
Rotaries
Slides
Tactiles
Tilt
Touch
Indicators
Accessories
Supplement

ROCKERS & PADDLES FOR TX MOUNTING FRAMES

D AT4148 .365" (9.27mm)
Wide Rocker

Material: Polyamide
Finish: Matte

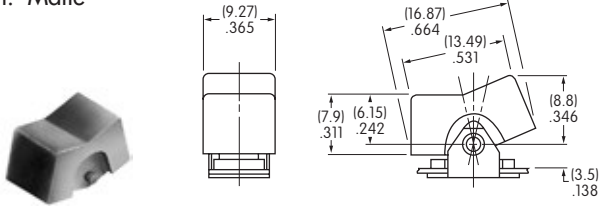

E AT4149 .365" (9.27mm)
Wide Paddle

Material: Polyamide
Finish: Matte

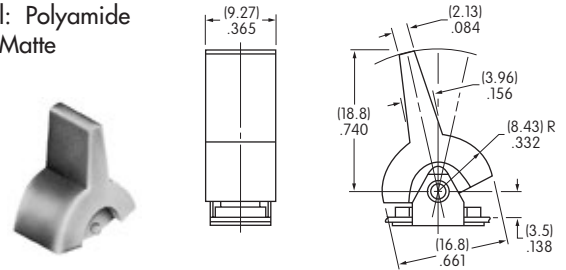

F AT4150 .450" (11.43mm)
Wide Rocker

Material: Polyamide
Finish: Matte

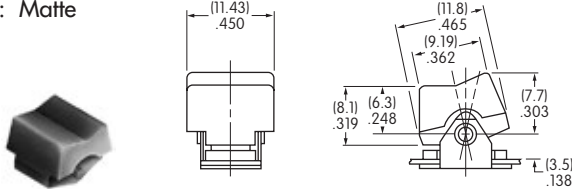

G AT4151 .450" (11.43mm)
Wide Paddle

Material: Polyamide
Finish: Matte

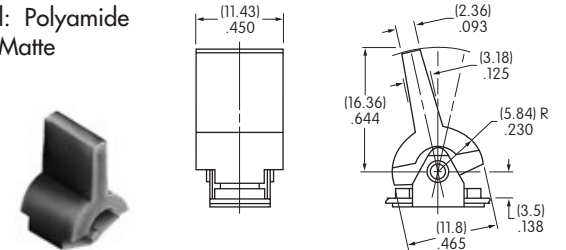

Cap Colors Available:



Black



White



Red



Yellow



Green



Blue



Gray

ROCKERS & PADDLES FOR TZ MOUNTING FRAMES

J AT4156 .595" (15.11mm)
Wide Rocker

Material: Polyamide
Finish: Matte

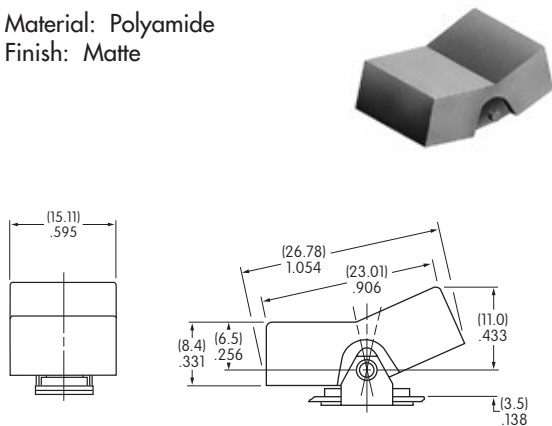

H AT4157 .595" (15.11mm)
Wide Paddle

Material: Polyamide
Finish: Matte

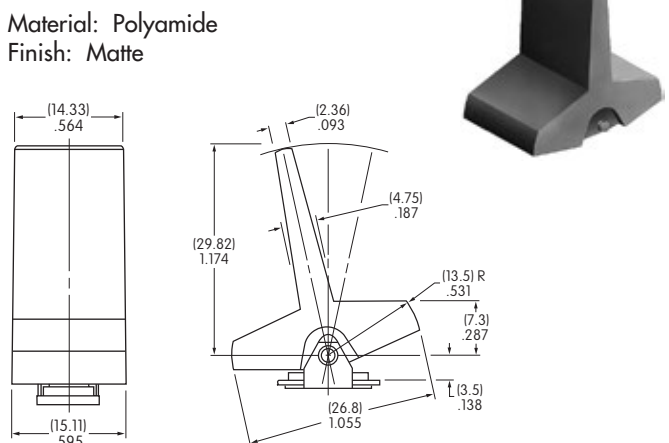

Cap Colors Available:



Black



White



Red



Yellow



Green



Blue



Gray

OPTIONAL SNAP-IN PANEL FRAMES

Used with AT4148 Rocker and AT4149 Paddle

AT064-1

Accommodates .047" ~ .090"
(1.2 ~ 2.3mm) panel thickness

Material: Polyamide
Finish: Matte
Color: Black

Mounted separately from switches

Cutout Tolerances:

Dimension A:
.797" ~ .803" (20.24 ~ 20.4mm)

Dimension B:
.495" ~ .505" (12.57 ~ 12.83mm)

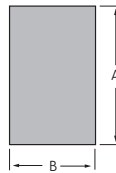

AT064-2

Accommodates .062" ~ .125"
(1.57 ~ 3.18mm) panel thickness

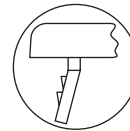
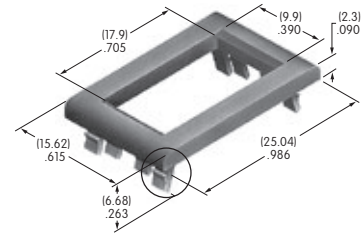

AT064-1 Enlarged Detail

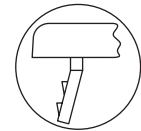

Used with AT4150 Rocker and AT4151 Paddle

AT065-1

Accommodates .047" ~ .090"
(1.2 ~ 2.3mm) panel thickness

Material: Polyamide
Finish: Matte
Color: Black

Mounted separately from switches

Cutout Tolerances:

Dimension A:
.595" ~ .605" (15.11 ~ 15.37mm)

Dimension B:
.495" ~ .500" (12.57 ~ 12.7mm)



AT065-2

Accommodates .062" ~ .125"
(1.57 ~ 3.18mm) panel thickness

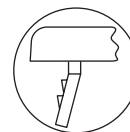
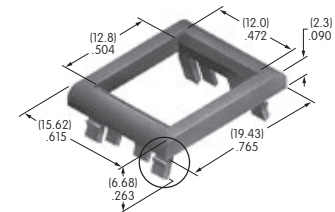

AT065-1 Enlarged Detail

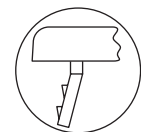

AT065-2 Enlarged Detail

Toggles

B Rockers

Pushbuttons

Illuminated PB

Programmable

Keylocks

Rotaries

Slides

Tactiles

Tilt

Touch

Indicators

Accessories

Supplement

TYPICAL SWITCH DIMENSIONS

Straight PC • Bracket

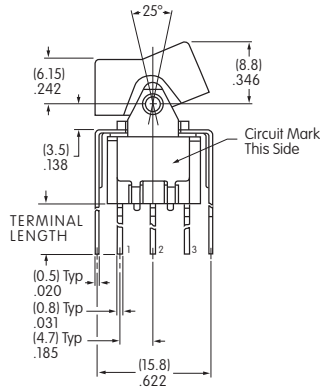

Single Pole

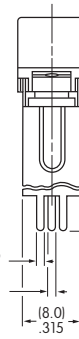

Double Pole

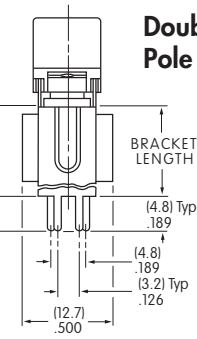

MN12TXG13-DC

Terminal Code:	Terminal Length:	Bracket Length:
13	.250" (6.35mm)	.465" (11.8mm)

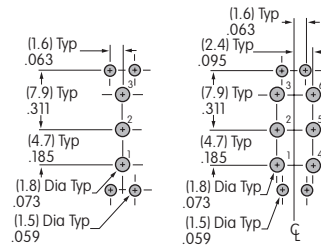

.150" (3.81mm) Right Angle PC

Single Pole

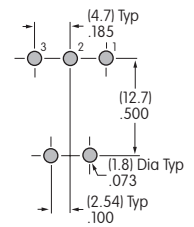
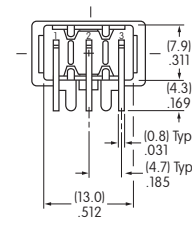
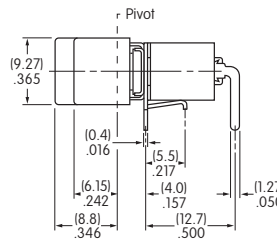
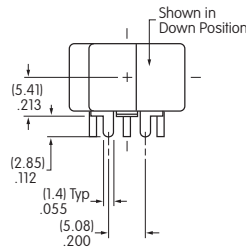

MN12TXG30-DC

.150" (3.81mm) Right Angle PC

Double Pole

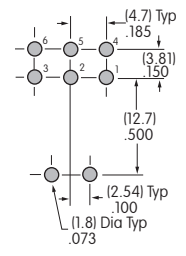
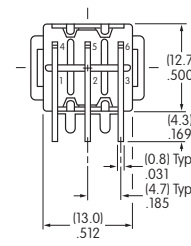
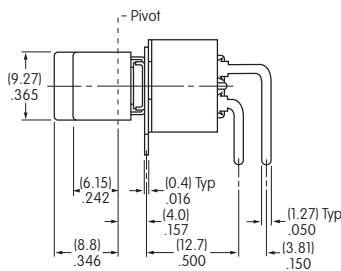
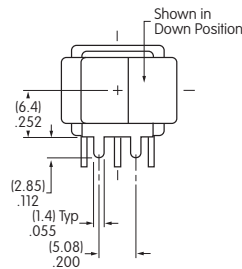

MN22TXG30-DC

TYPICAL SWITCH DIMENSIONS

Three Pole

.150" (3.81mm) Right Angle PC

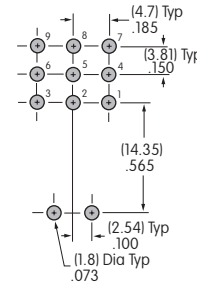
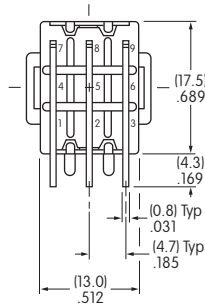
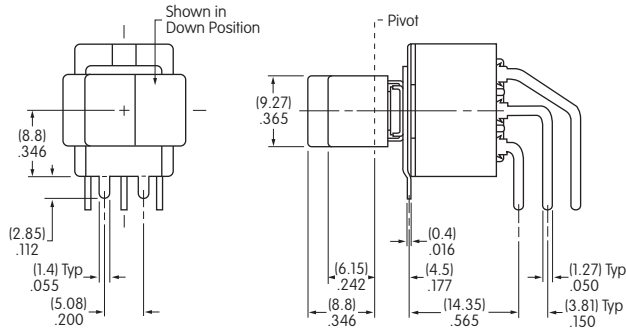

MN32TXG30-DC

Single Pole

.150" (3.81mm) Vertical PC

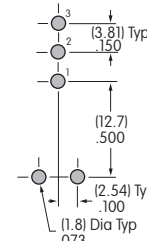
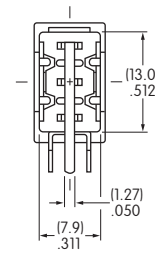
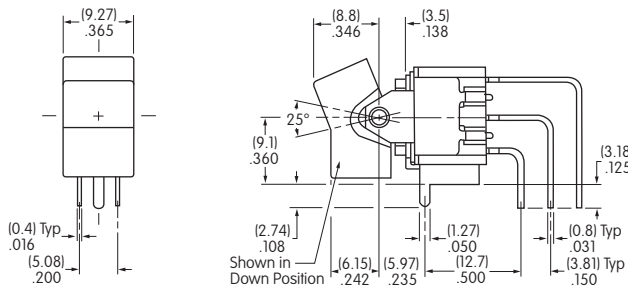

MN12TXG41-DC

Double Pole

.150" (3.81mm) Vertical PC

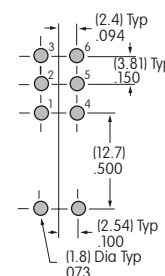
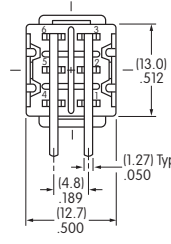
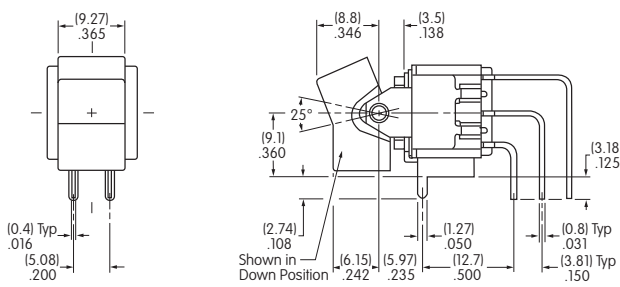

MN22TXG41-DC

Three Pole

.150" (3.81mm) Vertical PC

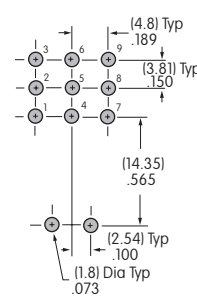
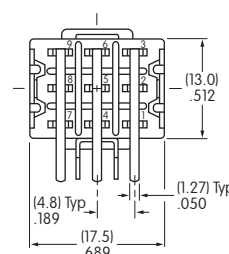
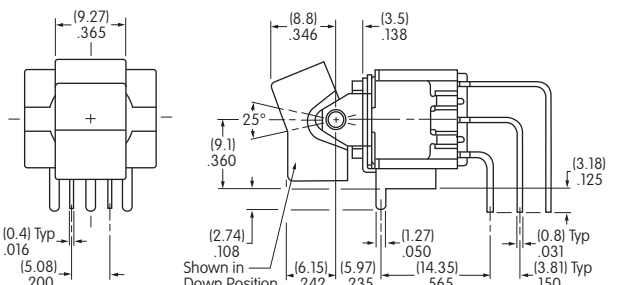

MN32TXG41-DC

TYPICAL SWITCH DIMENSIONS

Straight PC • Bracket

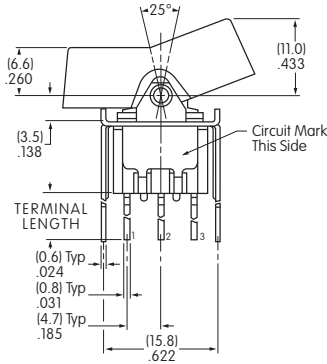

Single Pole

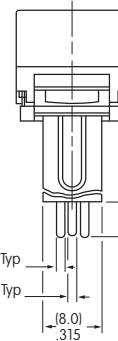

Double Pole

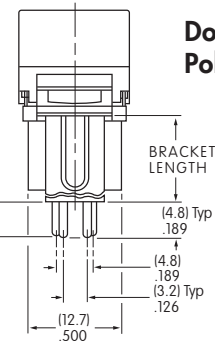

MN12TZG13-JC

Terminal Code:	Terminal Length:	Bracket Length:
13	.250" (6.35mm)	.465" (11.8mm)

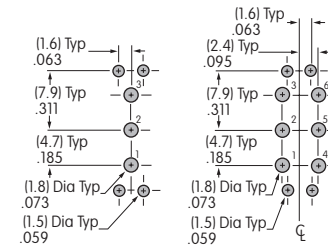

LEGENDS

NKK Switches can provide custom legends for caps. Contact factory for more information.

Suggested Printable Area for Cap

AT4148

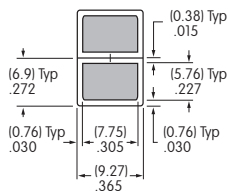

AT4150

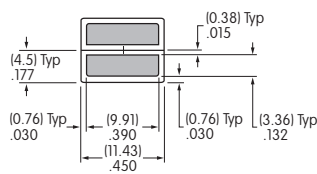

AT4156

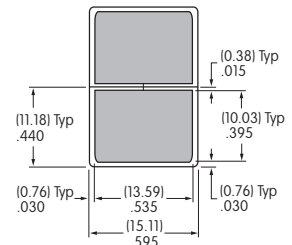

Shaded areas are printable areas.

Recommended Print Method: Pad Print. Epoxy based ink is recommended.

TYPICAL SWITCH ORDERING EXAMPLE

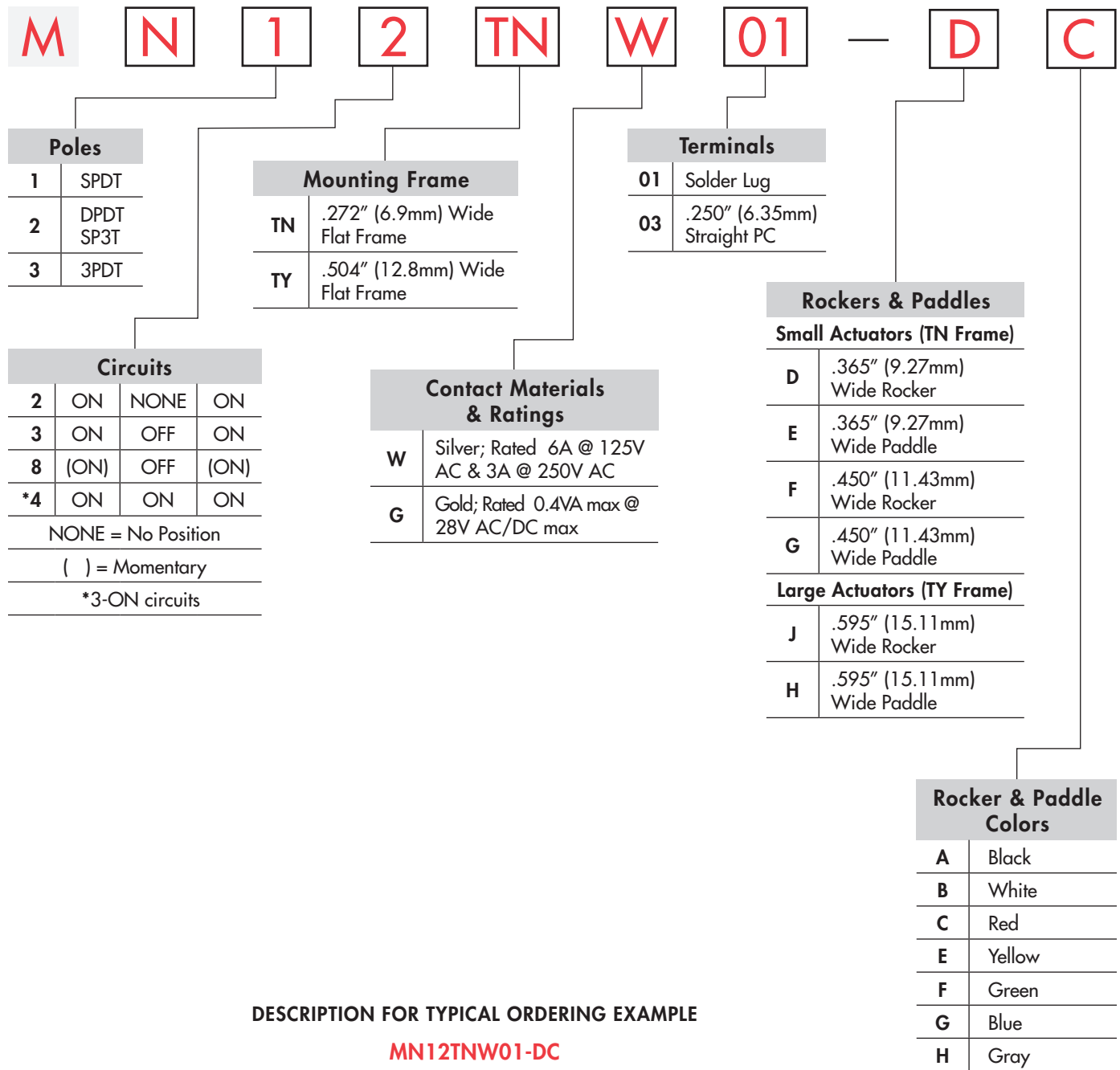

DESCRIPTION FOR TYPICAL ORDERING EXAMPLE

MN12TNW01-DC

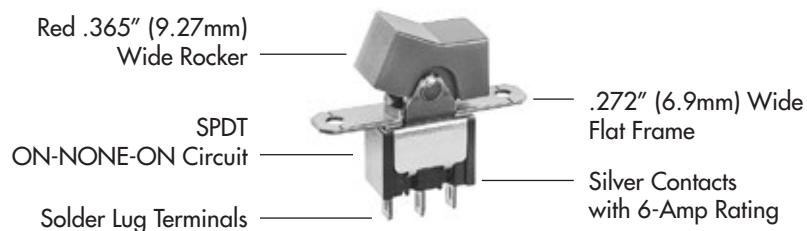

POLES & CIRCUITS

Pole	Model	Rocker Position			Connected Terminals			Throw & Schematics
		Down	Center	Up	Down	Center	Up	
NONE = No Position () = Momentary								
								Note: Terminal numbers are not actually on the switch.
SP	MN12 MN13 MN18	ON ON (ON)	NONE OFF OFF	ON ON (ON)	2-3	OPEN	2-1	SPDT
DP	MN22 MN23 MN28	ON ON (ON)	NONE OFF OFF	ON ON (ON)	2-3 5-6	OPEN	2-1 5-4	DPDT
3P	MN32 MN33 MN38	ON ON (ON)	NONE OFF OFF	ON ON (ON)	2-3 5-6 8-9	OPEN	2-1 5-4 8-7	3PDT

For 3 Throw (3-On)

Connected Terminals & Schematics

Pole	Model	Down	Center	Up	Down	Center	Up
SP	MN24	ON	ON	ON	 2-3 5-6	 2-3 5-4	 2-1 5-4

The SP3T model utilizes a double pole base.

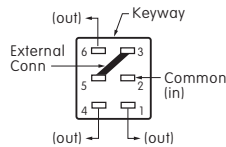

External connection must be made during field installation.

MOUNTING FRAMES

TN .272" (6.9mm)
Wide Flat Frame

Mounting hardware kit HK-1, as shown on the following page, must be ordered separately.

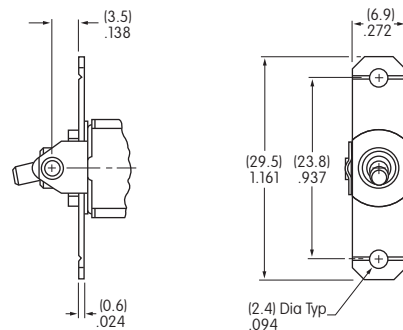

Small Actuators & Panel Cutouts for TN Frame (actuator details on the following pages)

AT4148

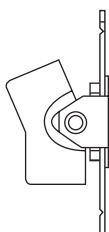

AT4149

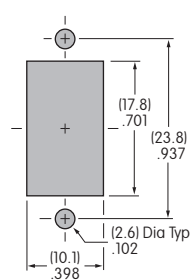
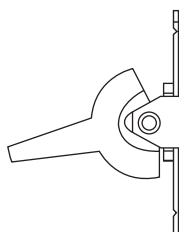

AT4150



AT4151

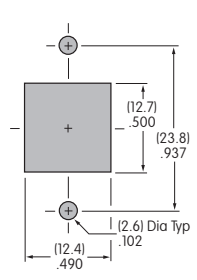
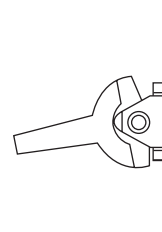

MOUNTING FRAMES

TY .504" (12.8mm)
Wide Flat Frame

Large Actuators & Panel Cutout for TY Frame
(actuator details on the following pages)

Mounting hardware kit HK-2, as shown on the following page, must be ordered separately.

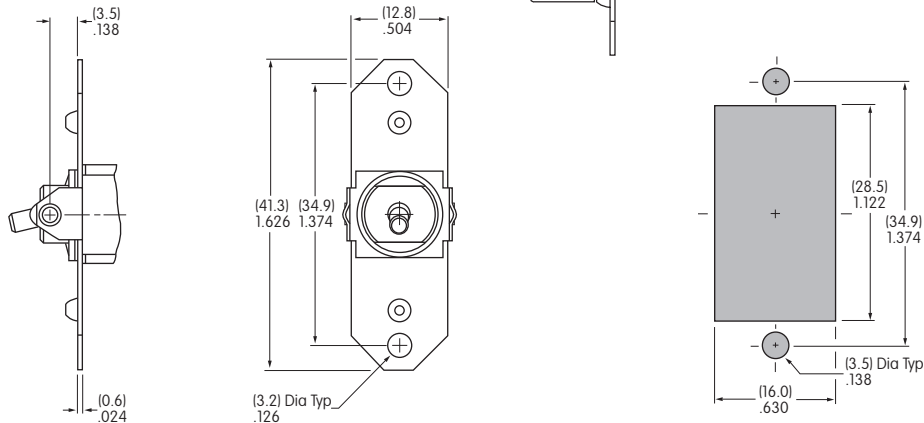

Face Panel Mounting

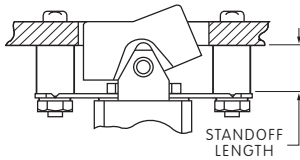

Flat frame devices may also be mounted to the face panel. Standoffs are used to recess the actuator and achieve an attractive front panel appearance.

Subpanel Mounting

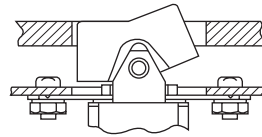

These devices are especially designed for subpanel mounting. When installed on a mounting plate behind the panel, hardware is completely concealed and the front panel retains a clean, attractive appearance.

Optional Snap-in Panel Frames

Further details are shown in the previous bracketed PC mount subsection.



AT064-1
AT064-2



AT065-1
AT065-2

Optional Hardware Kits for Subpanel or Face Panel Mounting

Frame	Panel Thickness	Standoff Length	Hardware Kit Number
TN Frame	.125" (3.175mm)	.233" (5.918mm)	ATHK-1
TY Frame	.125" (3.175mm)	.312" (7.925mm)	ATHK-2

Hardware kits include:
2 stainless steel screws, 2 hex nuts, 2 lockwashers, & 2 standoffs

CONTACT MATERIALS & RATINGS

W

Silver Power Level

MN12, MN22: 6A @ 125V AC, 3A @ 250V AC, 4A @ 30V DC
MN13, MN18, MN23: 6A @ 125V AC, 3A @ 250V AC, 3A @ 30V DC
MN28: 4A @ 125V AC, 3A @ 250V AC, 3A @ 30V DC
MN32: 4A @ 125V AC, 2A @ 250V AC, 3A @ 30V DC
MN33, MN38: 4A @ 125V AC, 2A @ 250V AC, 2A @ 30V DC
MN24: 3A @ 125V AC, 2A @ 250V AC, 2A @ 30V DC

G

Gold

Logic Level

0.4VA maximum @ 28V AC/DC maximum

Note: Complete explanation of operating range in Supplement section.

Gold over Silver

**Power Level
or Logic Level**

See above for each rating

Note: Gold over silver is available as a custom option. This dual rated option is suitable when two or more identical switches are used in logic and in power circuits within the same application. See Supplement section to find complete explanation of dual rating and operating range.

TERMINALS

01

Solder Lug

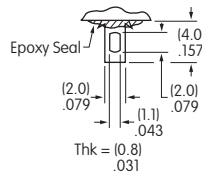

ROCKERS & PADDLES

For TN Frame

D

**AT4148 .365" (9.27mm)
Wide Rocker**



Material:
Polyamide
Finish: Matte

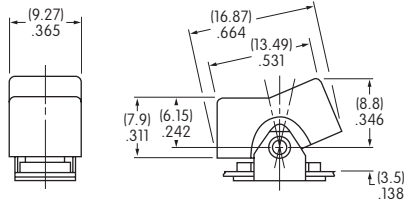

E

**AT4149 .365" (9.27mm)
Wide Paddle**



Material:
Polyamide
Finish: Matte

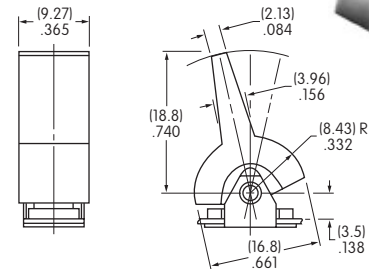

F

**AT4150 .450" (11.43mm)
Wide Rocker**



Material:
Polyamide
Finish: Matte

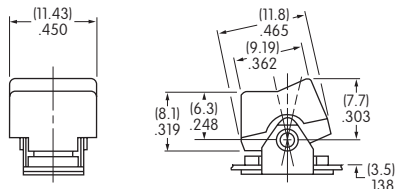

G

**AT4151 .450" (11.43mm)
Wide Paddle**



Material:
Polyamide
Finish: Matte

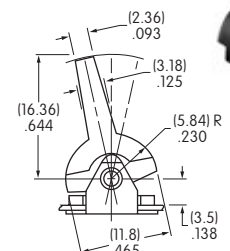

ROCKERS & PADDLES

For TY Frame

J AT4156 .595" (15.11mm)
Wide Rocker

Material:
Polyamide
Finish: Matte

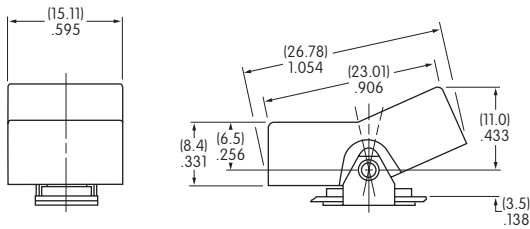
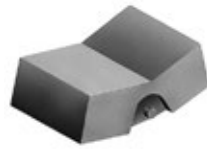

H AT4157 .595" (15.11mm)
Wide Paddle

Material:
Polyamide
Finish: Matte

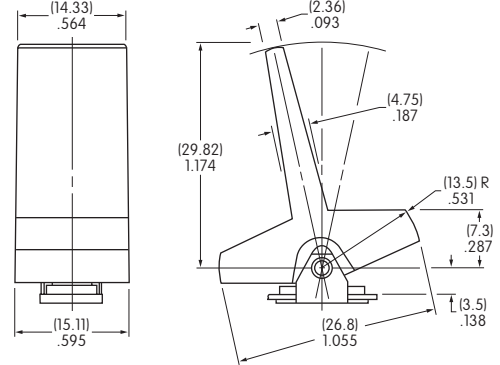

Cap Colors Available:

A

Black

B

White

C

Red

E

Yellow

F

Green

G

Blue

H

Gray

TYPICAL SWITCH DIMENSIONS

Single Pole

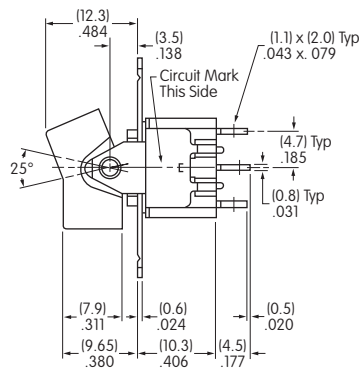
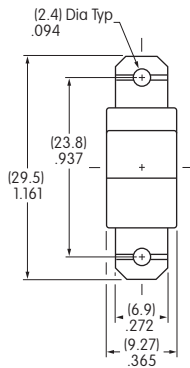

TN Frame • Solder Lug

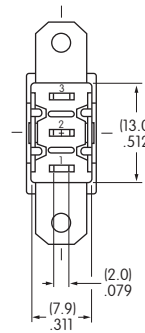

MN12TNW01-DC

Double Pole

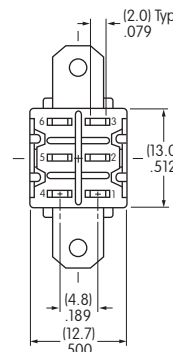
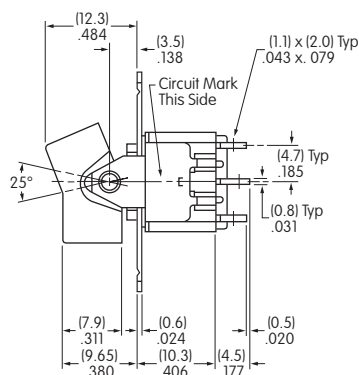
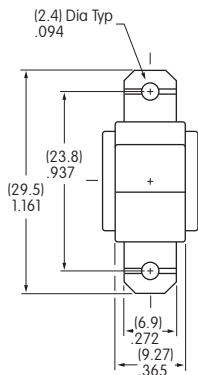

TN Frame • Solder Lug



MN22TNW01-DC

TYPICAL SWITCH DIMENSIONS

TN Frame • Solder Lug

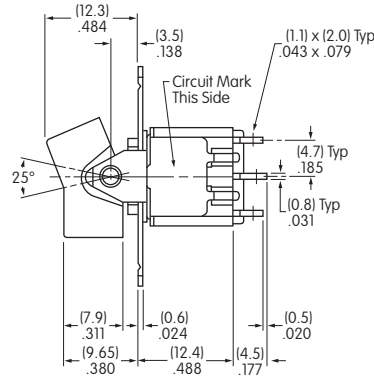
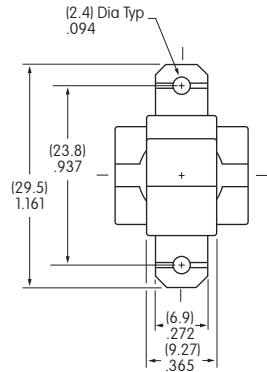

Three Pole

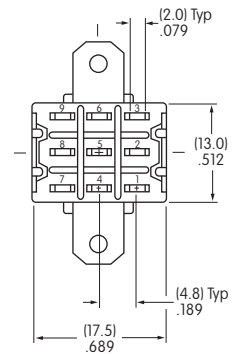

MN32TNW01-DC

TY Frame • Solder Lug

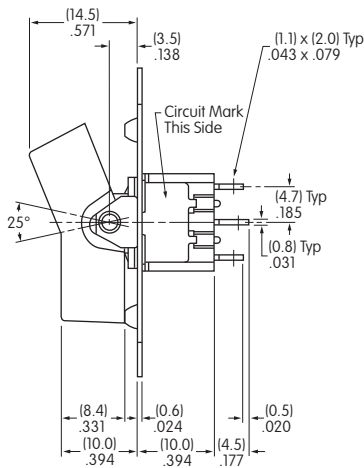
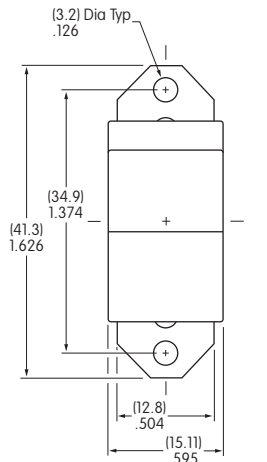

Single Pole

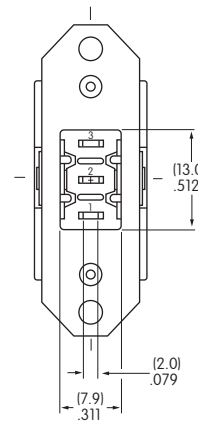

Double Pole

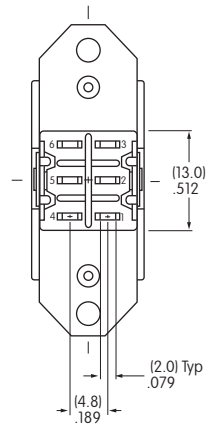

Double pole has barrier between terminals.

MN12TYW01-JC

TY Frame • Solder Lug

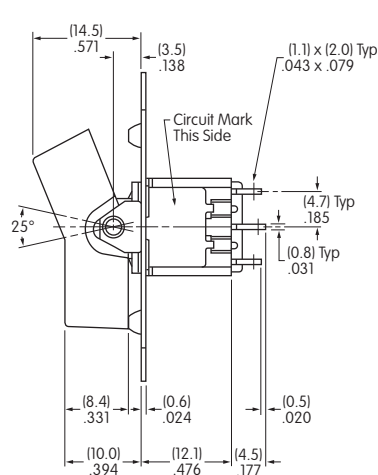
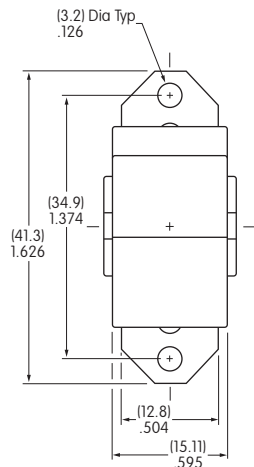

Three Pole

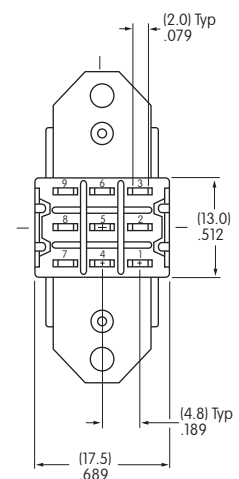

MN32TYW01-JC

LEGENDS

NKK Switches can provide custom legends for caps. Contact factory for more information.

Suggested Printable Area for Caps

AT4148

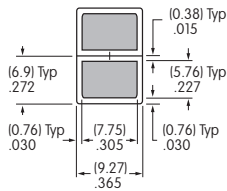

AT4150

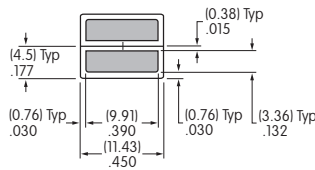

AT4156

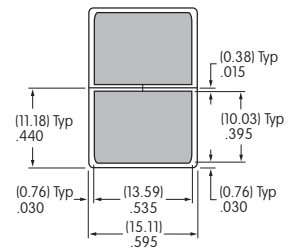

Shaded areas are printable areas.

Recommended Print Method:

Pad Print

Epoxy based ink is recommended.

- Supplement
- Accessories
- Indicators
- Touch
- Tilt
- Tactiles
- Slides
- Rotaries
- Keylocks
- Programmable
- Illuminated PB
- Pushbuttons
- B** Rockers
- Toggles