

# General Specifications

## Electrical Capacity (Resistive Load)

|                              |   |
|------------------------------|---|
| <b>Power Level (silver):</b> | 3A @ 125V AC or 2A @ 250V AC  |
| <b>Logic Level (gold):</b>   | 0.4VA maximum @ 28V AC/DC maximum<br>(Applicable Range 0.1mA ~ 0.1A @ 20mV ~ 28V) |

## Other Ratings

|                               |  |
|-------------------------------|--|
| <b>Contact Resistance:</b>    | 10 milliohms maximum for silver; 20 milliohms maximum for gold   |
| <b>Insulation Resistance:</b> | 1,000 megohms minimum @ 500V DC  |
| <b>Dielectric Strength:</b>   | 1,000V AC minimum between contacts for 1 minute minimum;<br>1,500V AC minimum between contacts & case for 1 minute minimum |
| <b>Mechanical Life:</b>       | 50,000 operations minimum  |
| <b>Electrical Life:</b>       | 25,000 operations minimum for silver; 50,000 operations minimum for gold   |
| <b>Contact Timing:</b>        | Nonshorting (break-before-make)  |
| <b>Total Travel:</b>          | On-None-On circuit .087" (2.2mm); all other circuits .138" (3.5mm)   |

## Materials & Finishes

|                             |  |
|-----------------------------|--|
| <b>Actuator:</b>            | Glass fiber reinforced PBT resin (UL94V-0)   |
| <b>Frame:</b>               | Stainless steel for terminals 01 & 03; phosphor bronze with tin plating for terminals 13, 30 & 40                                    |
| <b>Dust Cover:</b>          | Phosphor bronze with nickel plating  |
| <b>Case:</b>                | Diallyl phthalate resin (UL94V-0)  |
| <b>Movable Contacts:</b>    | Silver or Silver alloy (code W); copper or phosphor bronze with gold plating (code G);<br>or silver alloy with gold plating (code A) |
| <b>Stationary Contacts:</b> | Silver alloy with silver plating (code W); copper or brass with gold plating (code G);<br>or silver alloy with gold plating (code A) |
| <b>Terminals:</b>           | Copper or brass with silver or gold plating  |

## Environmental Data

|                              |   |
|------------------------------|---|
| <b>Operating Temp Range:</b> | -30°C through +85°C (-22°F through +185°F)  |
| <b>Humidity:</b>             | 90 ~ 95% humidity for 240 hours @ 40°C (104°F)  |
| <b>Vibration:</b>            | 10 ~ 55Hz with peak-to-peak amplitude of 1.5mm traversing the frequency range & returning<br>in 1 minute; 3 right angled directions for 2 hours |
| <b>Shock:</b>                | 500m/s <sup>2</sup> acceleration (tested in 6 right angled directions, with 5 shocks in each direction)   |

## Processing

|                   |   |
|-------------------|---|
| <b>Soldering:</b> | Wave Soldering recommended (PC Mount). See Profile A in Supplement section.<br>Manual Soldering: See Profile A in Supplement section. |
| <b>Cleaning:</b>  | These devices are not process sealed. Hand clean locally using alcohol based solution.  |

## Standards & Certifications

|                                |   |
|--------------------------------|---|
| <b>Flammability Standards:</b> | UL94V-0 rated actuator & case                                   |
| <b>UL:</b>                     | Contact NKK Switches for UL or CUL marking option requirements. |

# Distinctive Characteristics

Available in flat frame and bracketed PC mounting types.

Over-center actuator block and plunger design gives crisp actuation with clear indication of circuit status; this design also diminishes sparking and increases operating life.

Guide interlocked with actuator block prevents window locking and maintains correct plunger alignment to assure contact stability.

Antijamming design protects contacts from damage due to excessive downward force on the actuator.

High internal barriers between poles and insulating sheet between case and actuator block give added protection to contacts.

Specially composed silver alloy contacts for power applications or gold contacts for logic level applications give high contact reliability.

Prominent external insulating barriers increase insulation resistance and dielectric strength.

Epoxy sealed terminals prevent entry of flux, solvents, and other contaminants.

Clinching of frame to case well above base and terminals provides 1,500V dielectric strength.

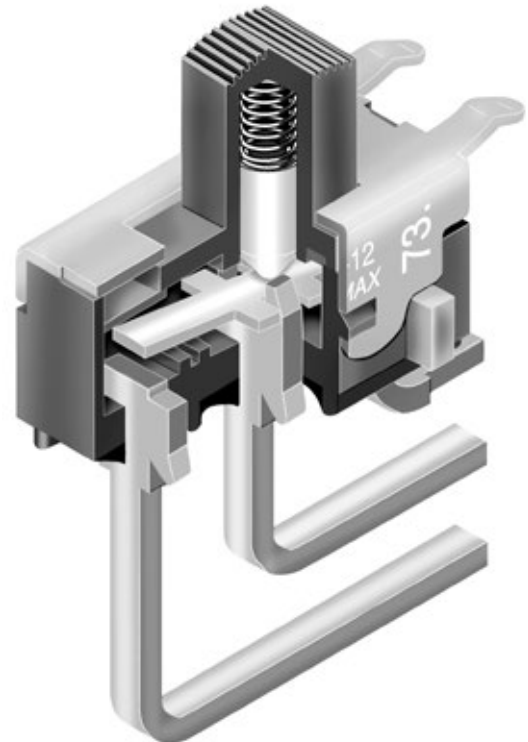

Actual Size

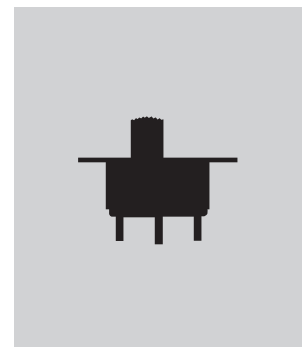

Toggles

Rockers

Pushbuttons

Illuminated PB

Programmable

Keylocks

Rotaries

**H** Slides

Tactiles

Tilt

Touch

Indicators

Accessories

Supplement

## TYPICAL SWITCH ORDERING EXAMPLE

**M**

**SN**

**1**

**2**

**A**

**S**

**G**

**30**

### Poles

|   |              |
|---|--------------|
| 1 | SPDT         |
| 2 | DPDT<br>SP3T |

### Actuators

|   |  |
|---|--|
| A | .150" (3.8mm) Wide for Single or Double Pole |
| B | .323" (8.2mm) Wide for Double Pole           |

### Contact Materials & Ratings

|   |   |
|---|---|
| W | Silver; Rated 3A @ 125V AC & 2A @ 250V AC |
| G | Gold; Rated 0.4VA max. @ 28V AC/DC max.   |

### Circuits

|   |    |      |    |
|---|----|------|----|
| 2 | ON | NONE | ON |
| 3 | ON | OFF  | ON |
| 4 | ON | ON   | ON |

NONE = No Position

### Mounting

|   |   |
|---|---|
| F | Panel Mount (Terminal 01 only)              |
| N | PCB Mount (Terminal 03 only)                |
| S | Bracket Mount (Terminals 13, 30, & 40 only) |

### Terminals

|    |                       |
|----|-----------------------|
| 01 | Solder Lug            |
| 03 | Straight PC           |
| 13 | Straight with Bracket |
| 30 | Right Angle PC        |
| 40 | Vertical PC           |

## DESCRIPTION FOR TYPICAL ORDERING EXAMPLE

**MSN12ASG30**



**POLES & CIRCUITS**

|      |                | Slide Position |             |          | Connected Terminals |        |         | Throw & Schematics                                     |
|------|----------------|----------------|-------------|----------|---------------------|--------|---------|--|
| Pole | Model          | Left           | Center      | Right    | Left                | Center | Right   |  |
|      |                |                |             |          |                     |        |         | Note: Terminal numbers are not actually on the switch. |
| SP   | MSN12<br>MSN13 | ON             | NONE<br>OFF | ON<br>ON | 2-1                 | OPEN   | 2-3     | SPDT<br>   |
| DP   | MSN22<br>MSN23 | ON             | NONE<br>OFF | ON<br>ON | 2-1 5-4             | OPEN   | 2-3 5-6 | DPDT<br>   |

For 3 Throw (3-On)

| Pole | Model | Connected Terminals & Schematics |                   |                   | External Connection   |
|------|-------|----------------------------------|-------------------|-------------------|---|
|      |       | Left                             | Center            | Right             |   |
| SP   | MSN24 | ON<br><br>2-1 5-4                | ON<br><br>2-3 5-4 | ON<br><br>2-3 5-6 | The SP3T model utilizes a double pole base.<br><br>External connections must be made during field installation.<br> |

**ACTUATORS**

**A** .150" (3.8mm) Wide for Single Pole

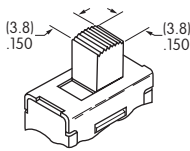

.150" (3.8mm) Wide for Double Pole

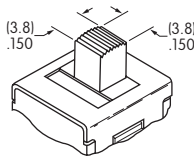

**B** .323" (8.2mm) Wide for Double Pole Only

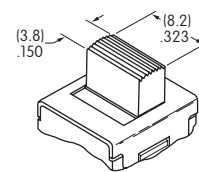

**CONTACT MATERIALS & RATINGS**

**W** Silver Power Level 3A @ 125V AC & 2A @ 250V AC

**G** Gold Logic Level 0.4VA maximum @ 28V AC/DC maximum

Note: Complete explanation of operating range in Supplement section.

Gold over Silver Power Level or Logic Level 3A @ 125V AC or 0.4VA maximum @ 28V AC/DC maximum

Note: Gold over silver is available as a custom option. This dual rated option is suitable when two or more identical switches are used in logic and in power circuits within the same application. See Supplement section to find complete explanation of dual rating and operating range.

Toggles  
Rockers  
Pushbuttons  
Illuminated PB  
Programmable  
Keylocks  
Rotaries  
Slides  
Tactiles  
Tilt  
Touch  
Indicators  
Accessories  
Supplement

## MOUNTING TYPES & TERMINALS

**F** Panel Mount  
(Combines with Solder  
Lug Terminal 01 only)

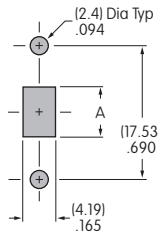

SP or DP with .150"  
(3.8mm) Actuator

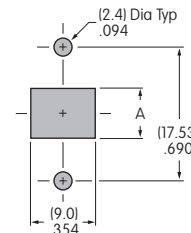

DP only with .323"  
(8.2mm) Actuator

**N** Straight PC Mount  
(Combines with  
Straight PC Terminal  
03 only)



Dimension A =  
.268" (6.8mm) for on-none-on  
.319" (8.1mm) for on-off-on & on-on-on

Maximum Panel Thickness: .197" (5.0mm)

**S** Support Bracket Mount  
(For Terminals 13, 30, & 40)

Maximum Panel Thickness:  
For Straight PC with Bracket Terminal 13: .197" (5.0mm)  
For Angle Mount Terminals 30 & 40: .177" (4.5mm)



**01** Solder Lug

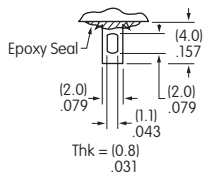

**03** Straight PC

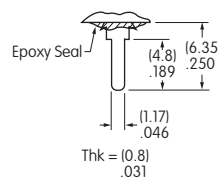

**13** Straight PC with Bracket

**30** Right Angle PC

**40** Vertical PC

## TYPICAL SWITCH DIMENSIONS

Solder Lug Terminals

Single Pole

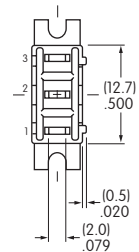
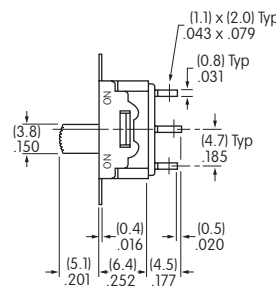
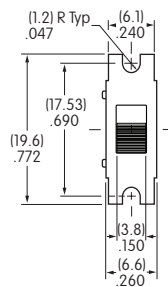

**MSN12AFW01**

Actuator in LEFT Position

Solder Lug Terminals

Double Pole

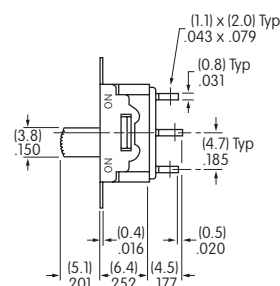
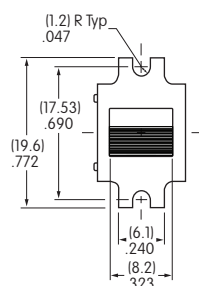
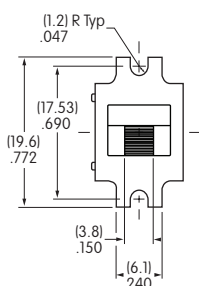

**MSN22BFW01**

Actuator in LEFT Position

Toggle  
Rockers  
Pushbuttons  
Illuminated PB  
Programmable  
Keylocks  
Rotaries  
Slides  
Tactiles  
Tilt  
Touch  
Indicators  
Accessories  
Supplement

TYPICAL SWITCH DIMENSIONS

Single Pole

Straight PC Terminals

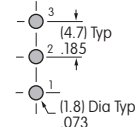
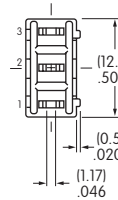
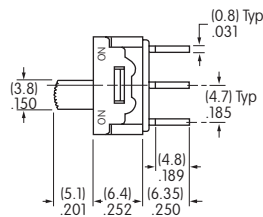
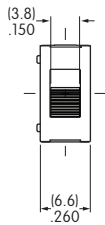

Actuator in LEFT Position

MSN12ANG03

Double Pole

Straight PC Terminals

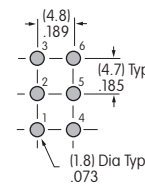
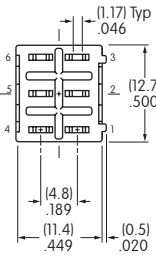
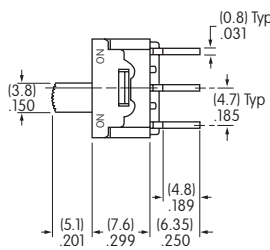
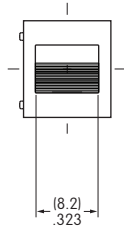
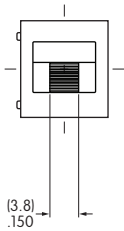

Actuator in LEFT Position

MSN22BNG03

Single Pole

Straight PC Terminals with Bracket

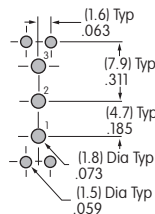
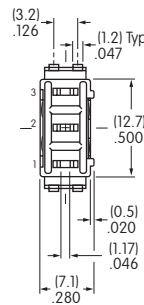
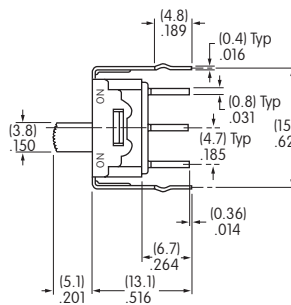
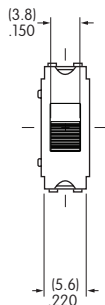

Actuator in LEFT Position

MSN12ASG13

Double Pole

Straight PC Terminals with Bracket

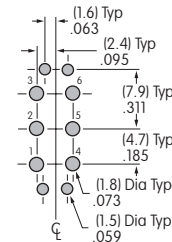
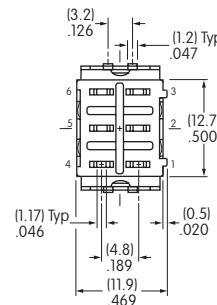
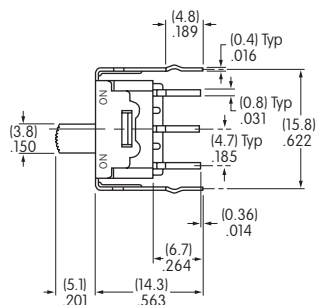
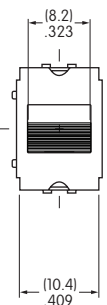
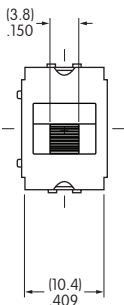

Actuator in LEFT Position

MSN23BSG13

## TYPICAL SWITCH DIMENSIONS

### Right Angle PC Terminals

### Single Pole

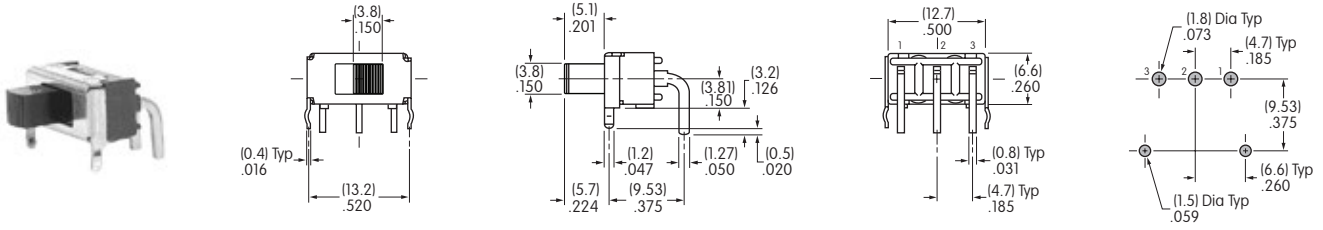

**MSN12ASG30**

Actuator in LEFT Position

### Right Angle PC Terminals

### Double Pole

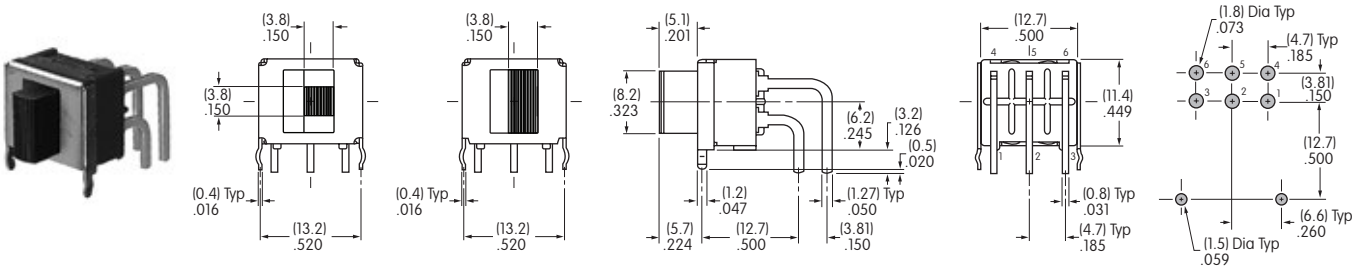

**MSN22BSG30**

Actuator in LEFT Position

### Vertical PC Terminals

### Single Pole

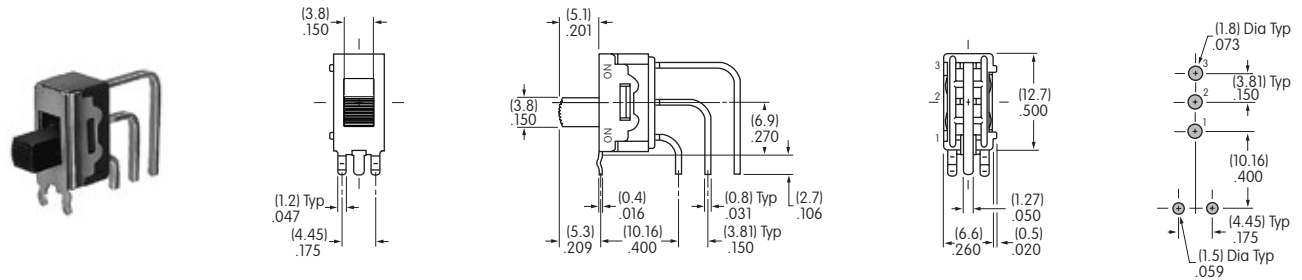

**MSN12ASG40**

Actuator in LEFT Position

### Vertical PC Terminals

### Double Pole

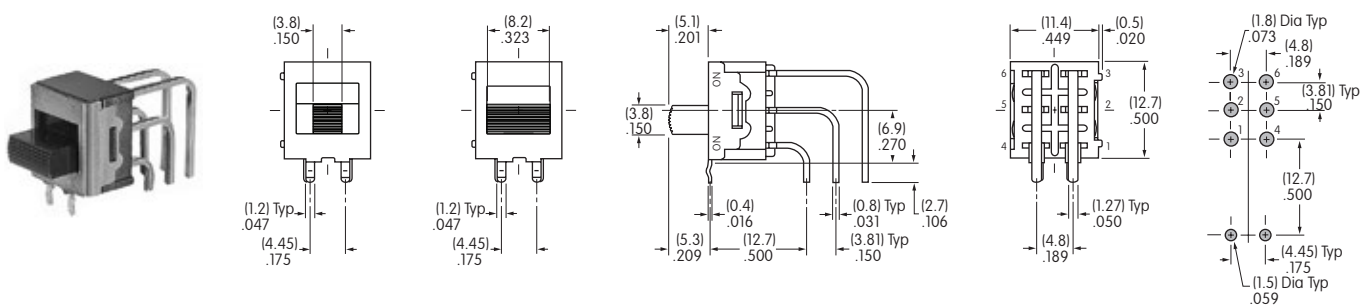

**MSN22BSG40**

Actuator in LEFT Position

Toggles  
Rockers  
Pushbuttons  
Illuminated PB  
Programmable  
Keylocks  
Rotaries  
Slides  
Tactiles  
Tilt  
Touch  
Indicators  
Accessories  
Supplement

