

# Electrode Holder BF-□(R)/BS-1(T)

CSM\_BF-\_(R)\_BS-1(T)\_DS\_E\_8\_5

## Complete Lineup for Use in High-temperature, High-pressure Environments or Where Exposed to Chemicals

- The BF-1 is ideal for liquids with low specific resistance, such as wastewater.
- The BF-□(R) is used when a strong mounting is required.
- The BS-1 is used when high-temperature, high-pressure resistant is required.
- The BS-1T is used when corrosion resistance is required.



**!** Refer to *Safety Precautions for Electrodes and Electrode Holders*.

## Ordering Information

### ■ Electrode Holders

Application	Model
<ul style="list-style-type: none"> <li>• Liquid with low specific resistance For 1-pole electrode</li> </ul>	BF-1
<ul style="list-style-type: none"> <li>• When sturdy mounting is required For 3-pole electrode</li> <li>For 3-pole electrode (2-wire)</li> <li>For 5-pole electrode</li> <li>For 5-pole electrode (2-wire)</li> </ul>	BF-3 BF-3R BF-5 BF-5R
<ul style="list-style-type: none"> <li>• Applications where resistance to high-temperature, high-pressure is required For 1-pole electrodes, 250°C, 1.96 MPa</li> </ul>	BS-1 BS-1S BS-1S-1 BS-1S2
<ul style="list-style-type: none"> <li>• High-pressure application where resistance to corrosion is required For 1-pole electrode, SUS304 981 kPa</li> <li>For 1-pole electrode, SUS316 981 kPa</li> <li>For 1-pole electrode, Titanium 981 kPa</li> <li>For 1-pole electrode, HAS B 981 kPa</li> <li>For 1-pole electrode, HAS C 981 kPa</li> </ul>	BS-1T SUS304 BS-1T SUS316 BS-1T TITANIUM BS-1T HAS B BS-1T HAS C

### ■ Accessories (Order Separately)

Application	Model
Protective Cover (For PS-□S and BF-3/5)	F03-11
Protective Cover (For BS-1, BS-1S and BS-1T)	F03-19
M18 Nut (For BS-1)	F03-17
M18 Nut (For BS-1T)	F03-18

**Note:** Refer to *Installing an Electrode Holder on a Tank* under Level Controller Installation in the Technical Guide for Level Controllers for information on Level Controller installation. Refer to *PS-□S(R) Electrode Holder Accessories (Order Separately)* for dimensions.

## Specifications

Item	Model	BF-1	BF-3 (R) (See note 1.)	BF-5 (R) (See note 1.)	BS-1	BS-1T
No. of Electrodes		1	3	5	---	---
Insulator material		PPS resin (Metallic section is SUS.)			Fluorocarbon polymer (PFA)	
Insulation resistance		100 MΩ				
Operating temperature		Electrode section: -10 to 150°C (with no icing) Terminal section: -10 to 70°C (with no icing or condensation)			250°C max.	180°C max.
Operating pressure		Atmospheric pressure			1.96 MPa (See note 2.)	981 kPa (See note 2.)
Applications		Liquids with low specific resistance, such as wastewater and cloudy water	General applications for purified water and wastewater		Boiler water level detection or high-temperature tanks	Acid or alkaline solution level detection

**Note: 1.** Two-wire Electrode Holders (R models) have a built-in resistance of 6.8 kΩ. They should be used with the Two-wire 61F Controllers.

**2.** Vapor leakage may occur when used outside of the specified operating temperature and pressure range. Use the Electrode Holder within the specified maximum operating temperature and pressure range according to the following pressure-temperature curve.

**Operating temperature and pressure range**

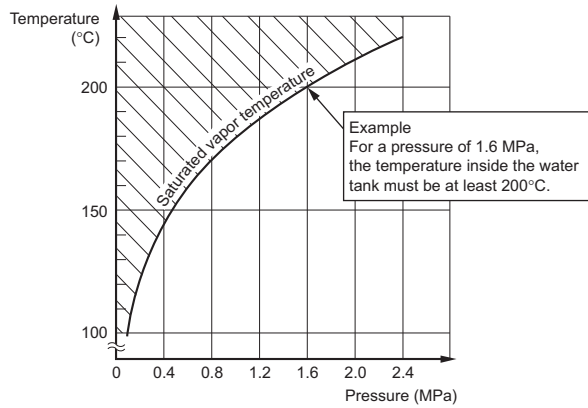

**Appearance**

<p><b>BF-1</b></p> <p>Tightening torque: 2.25 N·m</p> <p>Heat resistance: 70°C</p> <p>Heat resistance: 150°C</p>	<p><b>BF-3(R)</b> <b>BF-5(R)</b></p> <p>Tightening torque: 2.25 N·m</p> <p>Heat resistance: 70°C</p> <p>Heat resistance: 150°C</p> <p>(See note 1.)</p>	<p><b>BS-1</b></p> <p>Maximum terminal tightening torque: 137.2 N·cm</p> <p>Heat resistance: 150°C</p> <p>Heat resistance: 250°C</p> <p>Material at clamping section: iron (standard) SUS304 and SUS316 are also available. (See note 2.)</p>	<p><b>BS-1T</b></p> <p>SUS</p> <p>HAS Titanium</p> <p>(See note 3.)</p>
--	---	---	---

**Note: 1.** The F03-11 Protective Cover (sold separately) is available.

**2.**

Model	Material at tightening section	Screws
BS-1	Iron	M18 P = 1.5
BS-1S	SUS304	M18 P = 1.5
BS-1S-1	SUS304	PT1/2
BS-1S2	SUS316	M18 P = 1.5

**3.** Clamp screws are not provided for HAS B, HAS C, or titanium Electrode Holders. When placing an order, specify the type of material from the following five: SUS304, SUS316, HAS B, HAS C, or Titanium.

**Accessories Required for Connecting Electrodes to the BF-□(R) (Order Separately)**

**Electrode Shorter than 1 m**

The following items are required for each pole.

- 1 × F03-01 Electrode
- 1 × F03-03 Lock Nut

The Electrode can be cut anywhere to a desired control level.

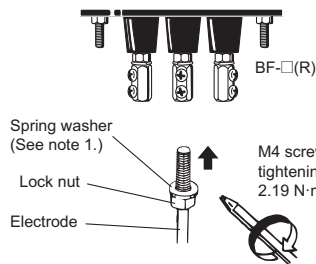

**Note: 1.** The spring washer comes with the lock nut.

Contact your OMRON representative to purchase a replacement if the spring washer wears out or is lost.

**2.** Refer to F03-□ for details on Electrodes, Connecting Nuts, Lock Nuts, and Separators.

**Electrode Longer than 1 m**

The following items are required for every additional meter of electrode for each pole.

- 1 × F03-01 Electrode
- 1 × F03-02 Connecting Nut
- 2 × F03-03 Lock Nuts

Use F03-14 1P Separators to prevent the electrodes from touching each another.

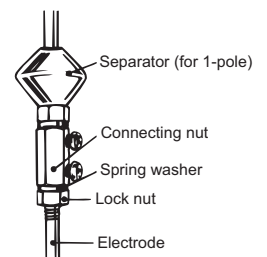

# Dimensions

Note: All units are in millimeters unless otherwise indicated.

## BF-1

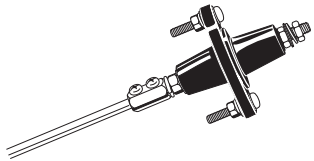

Weight: approx. 75 g

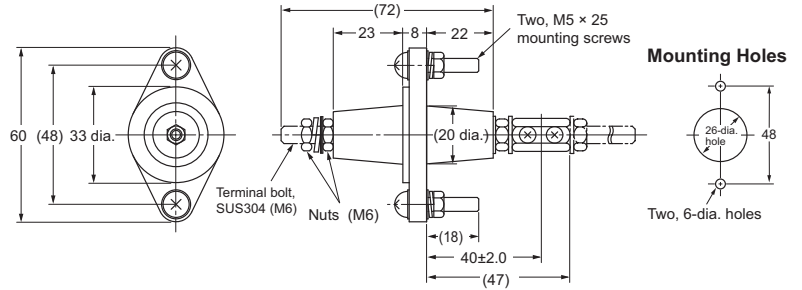

## BF-3(R)

## BF-5(R)

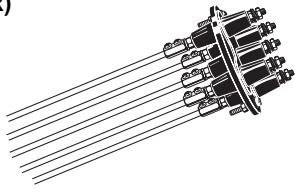

## BF-3(R)

Weight  
BF-3: approx. 210 g  
BF-3R: approx. 215 g

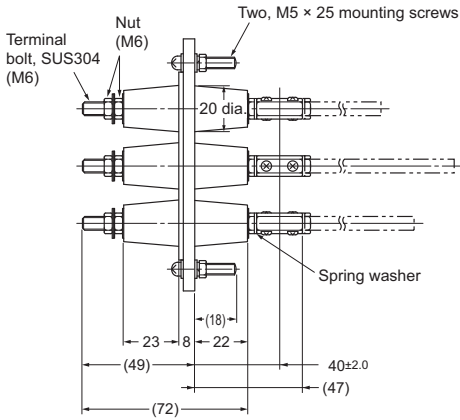

## BF-5(R)

Weight  
BF-5: approx. 360 g  
BF-5R: approx. 365 g

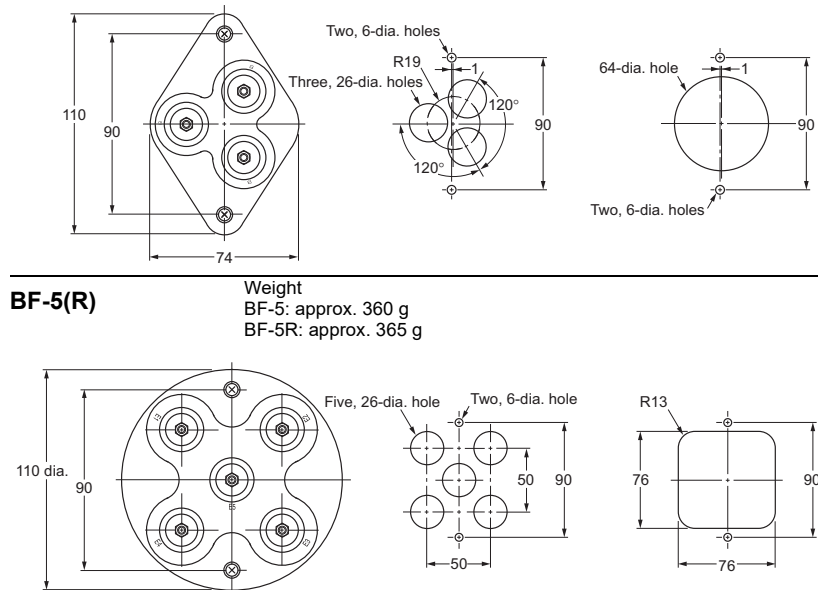

## BS-1(S)

## BS-1

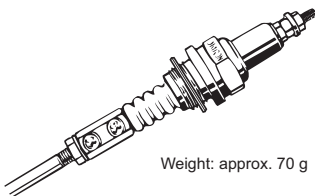

Weight: approx. 70 g

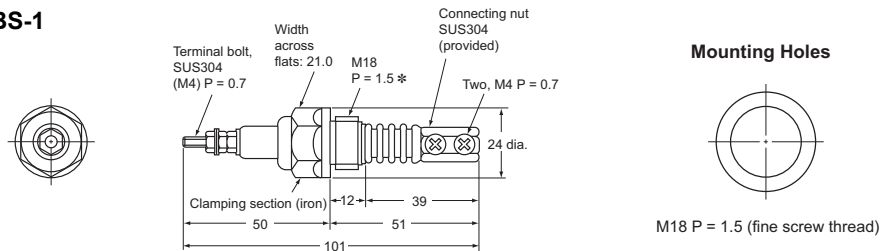

\*. If it is not necessary to seal the tank inside and outside.  
The Electrode can be secured with F03-17 Nuts.  
(Refer to page 1.)

## BS-1S BS-1S-1 BS-1S2

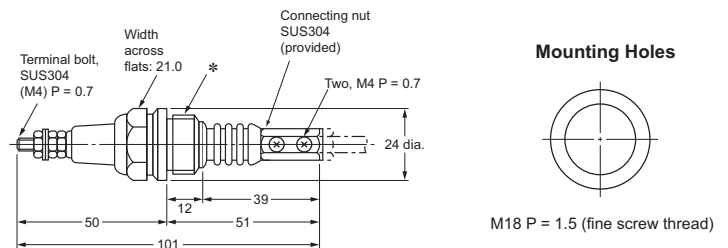

\*

BS-1S	BS-1S-1	BS-1S2
M18 P=1.5	Taper pipe thread PT 1/2 JIS B 0203	M18 P=1.5

BS-1T

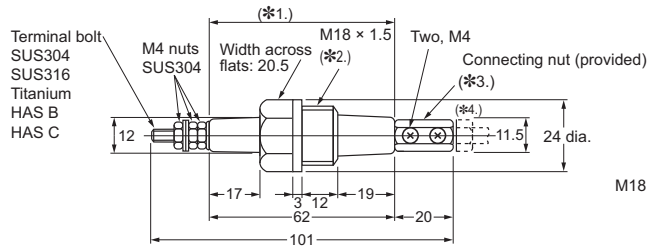
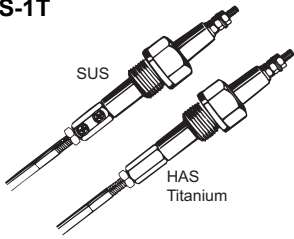

Mounting Holes

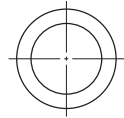

M18 P = 1.5 (fine screw thread)

<b>Material</b>	SUS304	SUS316	Titanium	HAS B	HAS C
<b>Weight</b>	Approx. 55 g	Approx. 55 g	Approx. 45 g	Approx. 65 g	Approx. 60 g

- \*1. All of the clamping section is made of fluororesin.
- \*2. If it is not necessary to seal the tank inside and outside. The Electrode can be secured with F03-18 Nuts. (Refer to page 1.)
- \*3. The material of the Connecting Nuts is the same as the material of the BS-1T. Connecting Nuts made of HAS B, HAS C, or titanium, however, do not have the screw or screw hole labeled 2-M4 in the figure.
- \*4. The section shown with dotted lines is sold separately.

## ■ Safety Precautions

Refer to *Safety Precautions for All Level Controllers*.

ALL DIMENSIONS SHOWN ARE IN MILLIMETERS.  
 To convert millimeters into inches, multiply by 0.03937. To convert grams into ounces, multiply by 0.03527.

In the interest of product improvement, specifications are subject to change without notice.

## Terms and Conditions Agreement

### Read and understand this catalog.

Please read and understand this catalog before purchasing the products. Please consult your OMRON representative if you have any questions or comments.

### Warranties.

(a) Exclusive Warranty. Omron's exclusive warranty is that the Products will be free from defects in materials and workmanship for a period of twelve months from the date of sale by Omron (or such other period expressed in writing by Omron). Omron disclaims all other warranties, express or implied.

(b) Limitations. OMRON MAKES NO WARRANTY OR REPRESENTATION, EXPRESS OR IMPLIED, ABOUT NON-INFRINGEMENT, MERCHANTABILITY OR FITNESS FOR A PARTICULAR PURPOSE OF THE PRODUCTS. BUYER ACKNOWLEDGES THAT IT ALONE HAS DETERMINED THAT THE PRODUCTS WILL SUITABLY MEET THE REQUIREMENTS OF THEIR INTENDED USE.

Omron further disclaims all warranties and responsibility of any type for claims or expenses based on infringement by the Products or otherwise of any intellectual property right. (c) Buyer Remedy. Omron's sole obligation hereunder shall be, at Omron's election, to (i) replace (in the form originally shipped with Buyer responsible for labor charges for removal or replacement thereof) the non-complying Product, (ii) repair the non-complying Product, or (iii) repay or credit Buyer an amount equal to the purchase price of the non-complying Product; provided that in no event shall Omron be responsible for warranty, repair, indemnity or any other claims or expenses regarding the Products unless Omron's analysis confirms that the Products were properly handled, stored, installed and maintained and not subject to contamination, abuse, misuse or inappropriate modification. Return of any Products by Buyer must be approved in writing by Omron before shipment. Omron Companies shall not be liable for the suitability or unsuitability or the results from the use of Products in combination with any electrical or electronic components, circuits, system assemblies or any other materials or substances or environments. Any advice, recommendations or information given orally or in writing, are not to be construed as an amendment or addition to the above warranty.

See <http://www.omron.com/global/> or contact your Omron representative for published information.

### Limitation on Liability: Etc.

OMRON COMPANIES SHALL NOT BE LIABLE FOR SPECIAL, INDIRECT, INCIDENTAL, OR CONSEQUENTIAL DAMAGES, LOSS OF PROFITS OR PRODUCTION OR COMMERCIAL LOSS IN ANY WAY CONNECTED WITH THE PRODUCTS, WHETHER SUCH CLAIM IS BASED IN CONTRACT, WARRANTY, NEGLIGENCE OR STRICT LIABILITY.

Further, in no event shall liability of Omron Companies exceed the individual price of the Product on which liability is asserted.

### Suitability of Use.

Omron Companies shall not be responsible for conformity with any standards, codes or regulations which apply to the combination of the Product in the Buyer's application or use of the Product. At Buyer's request, Omron will provide applicable third party certification documents identifying ratings and limitations of use which apply to the Product. This information by itself is not sufficient for a complete determination of the suitability of the Product in combination with the end product, machine, system, or other application or use. Buyer shall be solely responsible for determining appropriateness of the particular Product with respect to Buyer's application, product or system. Buyer shall take application responsibility in all cases.

NEVER USE THE PRODUCT FOR AN APPLICATION INVOLVING SERIOUS RISK TO LIFE OR PROPERTY OR IN LARGE QUANTITIES WITHOUT ENSURING THAT THE SYSTEM AS A WHOLE HAS BEEN DESIGNED TO ADDRESS THE RISKS, AND THAT THE OMRON PRODUCT(S) IS PROPERLY RATED AND INSTALLED FOR THE INTENDED USE WITHIN THE OVERALL EQUIPMENT OR SYSTEM.

### Programmable Products.

Omron Companies shall not be responsible for the user's programming of a programmable Product, or any consequence thereof.

### Performance Data.

Data presented in Omron Company websites, catalogs and other materials is provided as a guide for the user in determining suitability and does not constitute a warranty. It may represent the result of Omron's test conditions, and the user must correlate it to actual application requirements. Actual performance is subject to the Omron's Warranty and Limitations of Liability.

### Change in Specifications.

Product specifications and accessories may be changed at any time based on improvements and other reasons. It is our practice to change part numbers when published ratings or features are changed, or when significant construction changes are made. However, some specifications of the Product may be changed without any notice. When in doubt, special part numbers may be assigned to fix or establish key specifications for your application. Please consult with your Omron's representative at any time to confirm actual specifications of purchased Product.

### Errors and Omissions.

Information presented by Omron Companies has been checked and is believed to be accurate; however, no responsibility is assumed for clerical, typographical or proofreading errors or omissions.