

ASDMB

Request Samples



Check Inventory



ESD Sensitive



2.5 x 2.0 x 0.85 mm

RoHS/RoHS II Compliant

MSL Level = 1

Features

- Low Power Consumption <10mA
- Exceptional Stability +/- 10ppm Over Temp. at -40 to +105°C
- Compact QFN Plastic Packaging

Applications

- CCD Clock for VTR Camera
- Equipment Connected to PCs
- Low Profile Equipment
- Computers and Peripherals
- Portable Electronics
- Consumer Electronics
- Vibrant, Shock-Prone & Humid Environments for Industrial Equipment
- Demanding Military & Automotive Electronics

Common Key Electrical Specifications

Parameters	Min.	Typ.	Max.	Units	Notes
Frequency Range:	1.0		150	MHz	
Operating Temperature:	0		+70	°C	See options
Storage Temperature:	-55		+150	°C	
Overall Frequency Stability*:	-50		+50	ppm	See options
Supply Voltage (Vdd):	+1.8 ~ +3.3			V	
Output Load:			15, 25, or 40	pF	See options
	10			kΩ	
Symmetry:	45		55	%	@1/2Vdd
Startup Time:		1.5	3.0	ms	
Disable Time:		20	100	ns	
Disable Stand-by Current:			15	uA	
Tri-state Function (Stand-by) :	"1" (VIH≥0.75*Vdd) or Open: Oscillation				
	"0" (VIL<0.25*Vdd) : Hi Z			V	
Aging:	-5.0		+5.0	ppm	First year



5101 Hidden Creek Ln Spicewood TX 78669
 Phone: 512-371-6159 | Fax: 512-351-8858
 For terms and conditions of sales, please visit:
www.abracon.com

REVISED: 09-21-23

ABRACON IS
 ISO9001-2015
 CERTIFIED

ASDMB

Request Samples



Check Inventory



ESD Sensitive



2.5 x 2.0 x 0.85 mm

RoHS/RoHS II Compliant

MSL Level = 1

Key Electrical Specifications - Vdd = 1.8V

Parameters		Min.	Typ.	Max.	Units	Notes
Supply Current (no load):	1.0 to 39.9999MHz		5	15	mA	CL=0pF RL=∞ T=25°C (Standard CL: 15pF)
	40.0 to 79.9999MHz		6	15	mA	
	80.0 to 124.9999MHz		7	15	mA	
	125.0 to 150MHz		8	15	mA	
	1.0 to 39.9999MHz		6	15	mA	CL=0pF RL=∞ T=25°C (CL option: 25pF)
	40.0 to 79.9999MHz		7	15	mA	
	80.0 to 124.9999MHz		8	15	mA	
	125.0 to 150MHz		9	15	mA	
	1.0 to 39.9999MHz		7	15	mA	CL=0pF RL=∞ T=25°C (CL option: 40pF)
	40.0 to 79.9999MHz		8	15	mA	
	80.0 to 124.9999MHz		9	15	mA	
	125.0 to 150MHz		10	15	mA	
Output Voltage:	V _{OH}	0.8*Vdd			V	CL=15, 25, 40pF
	V _{OL}			0.2*Vdd	V	
Rise Time: Fall Time:	Tr		1.8	3.0	ns	CL=15pF; T=25°C 20%/80%*VDD
	Tf		1.0	3.0	ns	
	Tr		1.5	3.0	ns	CL=25pF; T=25°C 20%/80%*VDD
	Tf		1.2	3.0	ns	
	Tr		1.4	3.0	ns	CL=40pF; T=25°C 20%/80%*VDD
	Tf		1.1	3.0	ns	
Cycle to Cycle Jitter:			60		ps	F=100MHz
Period Jitter RMS:			10		ps	F=100MHz

INDUSTRIAL GRADE PLASTIC PACKAGE ULTRA MINIATURE PURE SILICON™ SMD CLOCK OSCILLATORS

ASDMB

Request Samples



Check Inventory



ESD Sensitive



2.5 x 2.0 x 0.85 mm

RoHS/RoHS II Compliant

MSL Level = 1

Key Electrical Specifications - Vdd = 2.5V

Parameters		Min.	Typ.	Max.	Units	Notes
Supply Current (no load):	1.0 to 39.9999MHz		6	15	mA	CL=0pF RL=∞ T=25°C (Standard CL: 15pF)
	40.0 to 79.9999MHz		7	15	mA	
	80.0 to 124.9999MHz		8	15	mA	
	125.0 to 150MHz		9	15	mA	
	1.0 to 39.9999MHz		7	15	mA	CL=0pF RL=∞ T=25°C (CL option: 25pF)
	40.0 to 79.9999MHz		8	15	mA	
	80.0 to 124.9999MHz		9	15	mA	
	125.0 to 150MHz		10	15	mA	
	1.0 to 39.9999MHz		8	16	mA	CL=0pF RL=∞ T=25°C (CL option: 40pF)
	40.0 to 79.9999MHz		9	16	mA	
	80.0 to 124.9999MHz		10	16	mA	
	125.0 to 150MHz		11	16	mA	
Output Voltage:	V _{OH}	0.8*Vdd			V	CL=15, 25, 40pF
	V _{OL}			0.2*Vdd	V	
	V _{OH}	0.9*Vdd			V	CL=40pF
	V _{OL}			0.1*Vdd	V	
Rise Time: Fall Time:	Tr		1.0	2.0	ns	CL=15pF; T=25°C 20%/80%*VDD
	Tf		0.9	2.0	ns	
	Tr		1.1	2.0	ns	CL=25pF; T=25°C 20%/80%*VDD
	Tf		0.9	2.0	ns	
	Tr		1.0	2.0	ns	CL=40pF; T=25°C 20%/80%*VDD
	Tf		0.9	2.0	ns	
Cycle to Cycle Jitter:			50		ps	F=100MHz
Period Jitter RMS:			5		ps	F=100MHz



5101 Hidden Creek Ln Spicewood TX 78669
 Phone: 512-371-6159 | Fax: 512-351-8858
 For terms and conditions of sales, please visit:
www.abracon.com

REVISED: 09-21-23

ABRACON IS
 ISO9001-2015
 CERTIFIED

INDUSTRIAL GRADE PLASTIC PACKAGE ULTRA MINIATURE PURE SILICON™ SMD CLOCK OSCILLATORS

ASDMB

Request Samples



Check Inventory



ESD Sensitive



2.5 x 2.0 x 0.85 mm

RoHS/RoHS II Compliant

MSL Level = 1

Key Electrical Specifications - Vdd = 3.3V

Parameters	Min.	Typ.	Max.	Units	Notes	
Supply Current (no load):	1.0 to 39.9999MHz		7	15	mA	CL=0pF RL=∞ T=25°C (Standard CL: 15pF)
	40.0 to 79.9999MHz		8	15	mA	
	80.0 to 124.9999MHz		9	15	mA	
	125.0 to 150MHz		10	15	mA	
	1.0 to 39.9999MHz		8	16	mA	CL=0pF RL=∞ T=25°C (CL option: 25pF)
	40.0 to 79.9999MHz		9	16	mA	
	80.0 to 124.9999MHz		10	16	mA	
	125.0 to 150MHz		11	16	mA	
	1.0 to 39.9999MHz		8	16	mA	CL=0pF RL=∞ T=25°C (CL option: 40pF)
	40.0 to 79.9999MHz		9	16	mA	
	80.0 to 124.9999MHz		10	16	mA	
	125.0 to 150MHz		11	16	mA	
Output Voltage:	V _{OH}	0.8*Vdd			V	CL=15pF
	V _{OL}			0.2*Vdd	V	
	V _{OH}	0.9*Vdd			V	CL=25, 40pF
	V _{OL}			0.1*Vdd	V	
Rise Time: Fall Time:	Tr		1.0	2.0	ns	CL=15pF; T=25°C 20%/80%*VDD
	Tf		0.9	2.0	ns	
	Tr		1.0	2.0	ns	CL=25pF; T=25°C 20%/80%*VDD
	Tf		0.9	2.0	ns	
	Tr		0.8	2.0	ns	CL=40pF; T=25°C 20%/80%*VDD
	Tf		0.8	2.0	ns	
Cycle to Cycle Jitter:			50		ps	F=100MHz
Period Jitter RMS:			5		ps	F=100MHz



5101 Hidden Creek Ln Spicewood TX 78669
 Phone: 512-371-6159 | Fax: 512-351-8858
 For terms and conditions of sales, please visit:
www.abracon.com

REVISED: 09-21-23

ABRACON IS
 ISO9001-2015
 CERTIFIED

ASDMB

Request Samples



Check Inventory



ESD Sensitive



2.5 x 2.0 x 0.85 mm
 RoHS/RoHS II Compliant
 MSL Level = 1

Absolute Maximum Ratings

Item	Min.	Max.	Units	Condition
Supply Voltage	-0.3	+4.0	V	
Input Voltage	-0.3	Vdd+0.3	V	
Junction Temp.		+150	°C	
Storage Temp.	-55	+150	°C	
Soldering Temp.		+260	°C	40sec max
ESD			V	
HBM		4,000		
MM		200		
CDM		1,500		

ASDMB

Request Samples 

Check Inventory 



2.5 x 2.0 x 0.85 mm
 RoHS/RoHS II Compliant
 MSL Level = 1

Options and Part Identification

ASDMB - MHz - - -

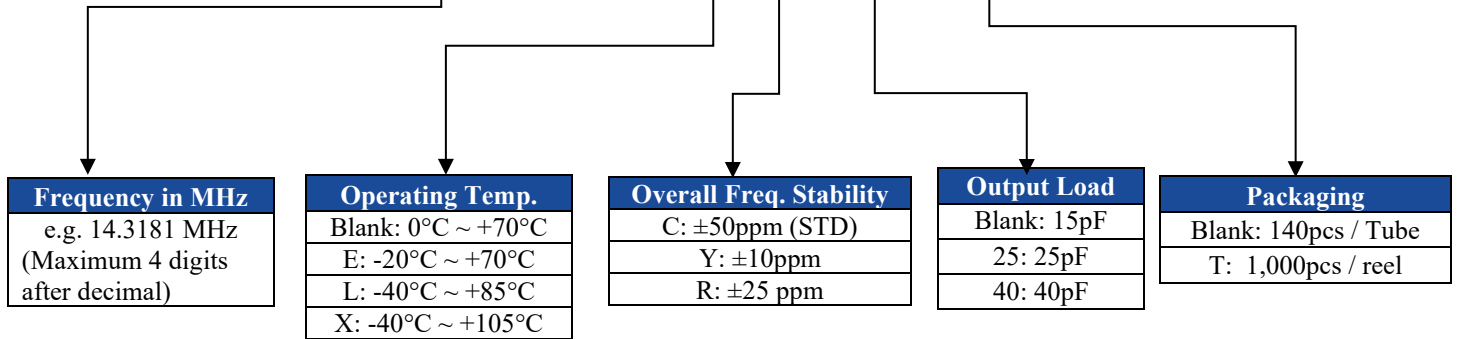

ASDMB

Request Samples 

Check Inventory 



2.5 x 2.0 x 0.85 mm
 RoHS/RoHS II Compliant
 MSL Level = 1

Mechanical Dimensions

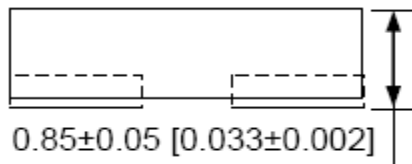
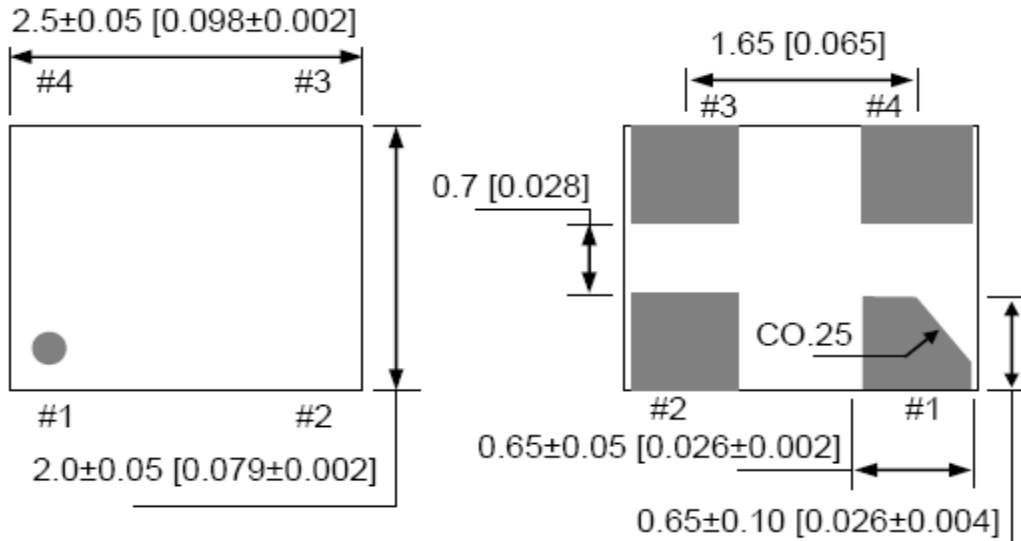

No	Pin Terminal
1	Standby
2	GND
3	Output
4	VDD

Recommended Land Pattern

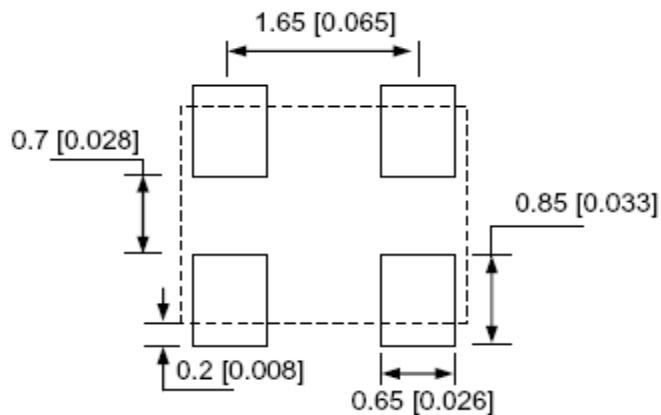

Note: Recommend using an approximately 0.01uF bypass capacitor between PIN 2 and 4.

Dimensions: mm(inches)



5101 Hidden Creek Ln Spicewood TX 78669
 Phone: 512-371-6159 | Fax: 512-351-8858
 For terms and conditions of sales, please visit:
www.abracon.com

REVISED: 09-21-23

ABRACON IS
 ISO9001-2015
 CERTIFIED

ASDMB

Request Samples

Check Inventory



2.5 x 2.0 x 0.85 mm
RoHS/RoHS II Compliant
MSL Level = 1

Reflow Profile [JEDEC J-STD-020]

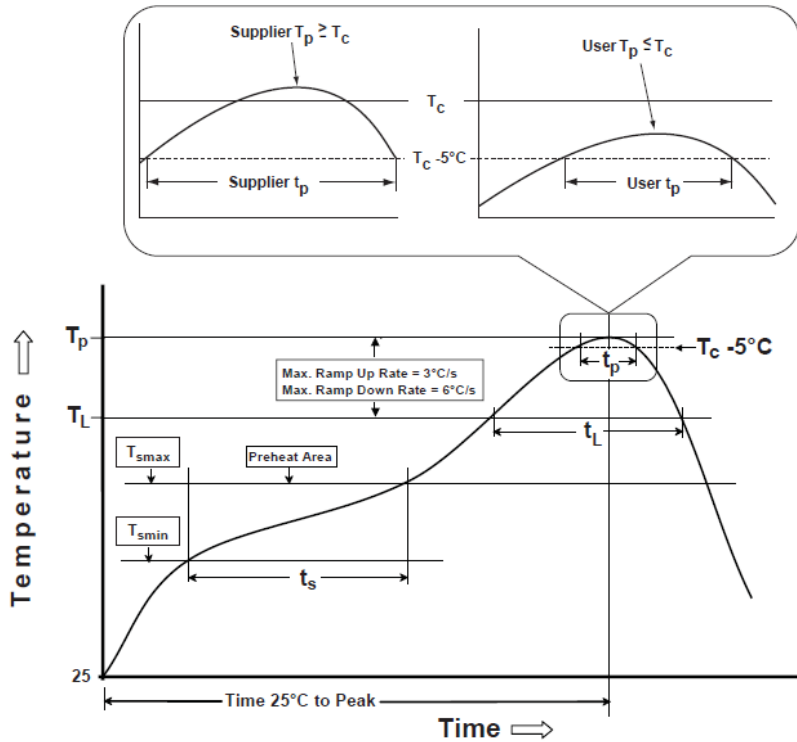

Table 1

SnPb Eutectic Process
Classification Temperatures (T_c)

Package Thickness	Volume mm ³ <350	Volume mm ³ ≥350
<2.5 mm	235 °C	220 °C
≥2.5 mm	220 °C	220 °C

Table 2

Pb-Free Process
Classification Temperatures (T_c)

Package Thickness	Volume mm ³ <350	Volume mm ³ 350-2000	Volume mm ³ >2000
<1.6 mm	260 °C	260 °C	260 °C
1.6 mm - 2.5 mm	260 °C	250 °C	245 °C
>2.5 mm	250 °C	245 °C	245 °C

Profile Feature	Sn-Pb Eutectic Assembly	Pb-Free Assembly
Preheat / soak		
Temperature minimum (T_{smin})	100°C	150°C
Temperature maximum (T_{smax})	150°C	200°C
Time (T_{smin} to T_{smax}) (t_s)	60 - 120 sec.	60 - 120 sec.
Average ramp-up rate (T_{smax} to T_p)	3°C/sec. max	3°C/sec. max
Liquidous temperature (T_L)	183°C	217°C
Time at liquidous (t_L)	60 - 150 sec.	60 - 150 sec.
Peak package body temperature (T_p)*	see Table 1	see Table 2
Time (t_p)** within 5°C of the specified classification temperature (T_c)	20 sec.	30 sec.
Ramp-down rate (T_p to T_{smax})	6°C/sec. max	6°C/sec. max
Time 25°C to peak temperature	6 min. max	8 min. max
Reflow cycles	2 max	2 max

*Tolerance for peak profile temperature (T_p) is defined as a supplier minimum and a user maximum.

**Tolerance for time at peak profile temperature (t_p) is defined as supplier minimum and a user maximum.



5101 Hidden Creek Ln Spicewood TX 78669
Phone: 512-371-6159 | Fax: 512-351-8858
For terms and conditions of sales, please visit:
www.abracon.com

REVISED: 09-21-23

ABRACON IS
ISO9001-2015
CERTIFIED

INDUSTRIAL GRADE PLASTIC PACKAGE ULTRA MINIATURE PURE SILICON™ SMD CLOCK OSCILLATORS

ASDDB

Request Samples



Check Inventory



ESD Sensitive



2.5 x 2.0 x 0.85 mm
RoHS/RoHS II Compliant
MSL Level = 1

Packaging

T= 1,000pcs/reel (D=180mm)

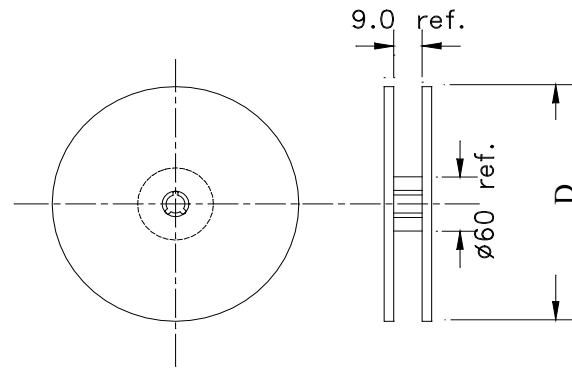
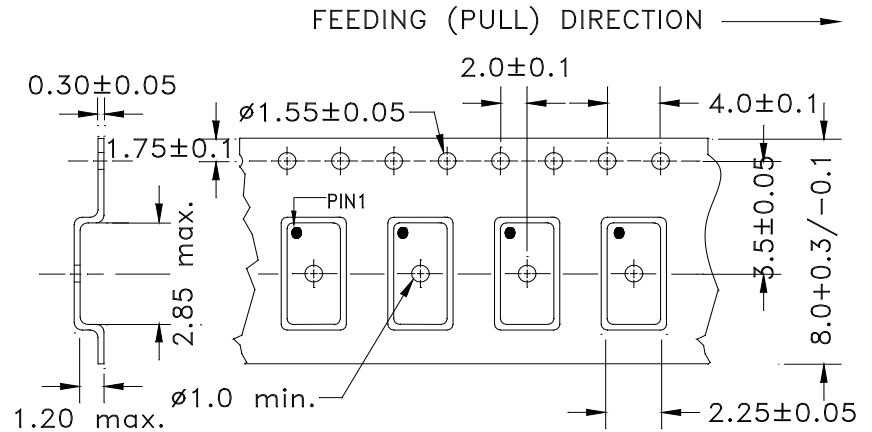

Tube: 140 pcs/tube

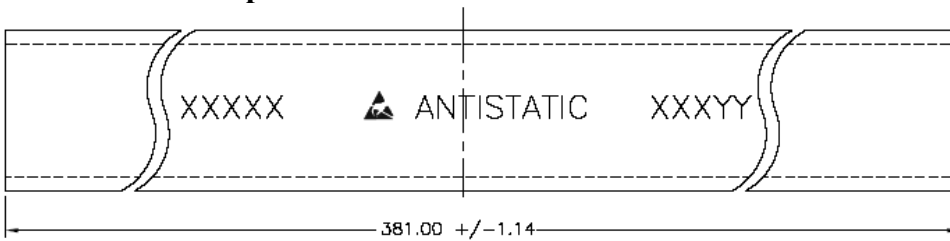

Unit orientation in tube:



Dimensions: mm

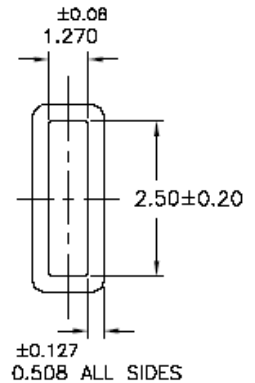

ATTENTION: Abracon LLC's products are COTS – Commercial-Off-The-Shelf products; suitable for Commercial, Industrial and, where designated, Automotive Applications. Abracon's products are not specifically designed for Military, Aviation, Aerospace, Life-dependent Medical applications or any application requiring high reliability where component failure could result in loss of life and/or property. For applications requiring high reliability and/or presenting an extreme operating environment, written consent and authorization from Abracon LLC is required. Please contact Abracon LLC for more information.



5101 Hidden Creek Ln Spicewood TX 78669
Phone: 512-371-6159 | Fax: 512-351-8858
For terms and conditions of sales, please visit:
www.abracon.com

REVISED: 09-21-23

ABRACON IS
ISO9001-2015
CERTIFIED