

# PLASTIC PACKAGE ULTRA MINIATURE PURE SILICON™ CLOCK OSCILLATORS

ASVM

Request Samples



Check Inventory



ESD Sensitive



7.0 x 5.0 x 0.85 mm

RoHS/RoHS II Compliant

MSL Level = 1

## Features

- Low Power Consumption
- Exceptional Stability Over Temp. at -40°C to +85°C
- Low Cost-Compact QFN Plastic Packaging
- Compact Package design

## Applications

- CCD Clock for VTR Camera
- Equipment Connected to PCs
- Low Profile Equipment
- Computers and Peripherals
- Portable Electronics
- Consumer Electronics
- Vibrant, Shock-Prone & Humid Environments for Industrial Equipment
- Demanding Military & Automotive Electronics

## Key Electrical Specifications

Parameters	Min.	Typ.	Max.	Units	Notes
Frequency Range:	1.0		150	MHz	
Operating Temperature:	0		+70	°C	See options
Storage Temperature:	-55		+150	°C	
Supply Voltage (Vdd):	+1.8 ~ +3.3			V	See options
Supply Current (no load):	1.0 to 39.9999MHz	7	15	mA	Vdd=3.3V No load RL=∞ T=25°C
	40.0 to 79.9999MHz	8	15		
	80.0 to 124.9999MHz	9	15		
	125.0 to 150MHz	10	15		
Output Voltage:	V <sub>OH</sub>	0.8*V <sub>dd</sub>		V	15pF
	V <sub>OL</sub>		0.2*V <sub>dd</sub>		
Rise Time:		1.3	3.0	ns	15pF; T=25°C 20%/80%*VDD
Fall Time:		1.3	3.0		
Output Load:	15pF max / 10kΩ min.			pF	
Symmetry:	45		55	%	@1/2Vdd
Startup Time:		1.5	3.0	ms	
Disable Time:		20	100	ns	
Disable Stand-by Current:			15	uA	
Tri-state Function (Stand-by) :	"1" (VIH≥0.75*Vdd) or Open: Oscillation "0" (VIH<0.25*Vdd) : Hi Z			V	
Cycle to cycle jitter:		60		ps	F=100MHz
Aging:	-5.0		+5.0	ppm	First year



5101 Hidden Creek Ln Spicewood TX 78669  
 Phone: 512-371-6159 | Fax: 512-351-8858  
 For terms and conditions of sales, please visit:  
[www.abracon.com](http://www.abracon.com)

REVISED: 09-21-23

ABRACON IS  
 ISO9001-2015  
 CERTIFIED

# PLASTIC PACKAGE ULTRA MINIATURE PURE SILICON™ CLOCK OSCILLATORS

ASVM

Request Samples



Check Inventory



ESD Sensitive



7.0 x 5.0 x 0.85 mm  
RoHS/RoHS II Compliant  
MSL Level = 1

## Absolute Maximum Ratings

Parameters	Min.	Max.	Unit	Conditions
Supply Voltage	-0.3	+4.0	V	
Input Voltage	-0.3	Vdd+0.3	V	
Junction Temp.		+150	°C	
Storage Temp.	-55	+150	°C	
Soldering Temp.		+260	°C	40sec max
ESD				
HBM		2,000		
MM		200		
CDM		500	V	

# PLASTIC PACKAGE ULTRA MINIATURE PURE SILICON™ CLOCK OSCILLATORS

ASVM

Request Samples



Check Inventory



ESD Sensitive



7.0 x 5.0 x 0.85 mm  
RoHS/RoHS II Compliant  
MSL Level = 1

## Options and Part Identification (left blank if standard)

ASVM  -  MHz -   -

Supply Voltage
1: 3.3 ± 0.3V
2: 3.0 ± 0.3V
3: 2.5 ± 0.2V
4: 1.8 ± 0.15V
5: 2.8 ± 0.2V

Frequency in MHz
e.g. 14.3181 MHz (Maximum 4 digits after decimal)

Operating Temp.
Blank: 0°C ~ +70°C
E: -20°C ~ +70°C
L: -40°C ~ +85°C

Operating Freq. Stability
Blank: ±100ppm
R: ±25ppm
C: ±50ppm

Packaging
Blank: 50pcs / Tube
T: 1,000pcs / reel

# PLASTIC PACKAGE ULTRA MINIATURE PURE SILICON™ CLOCK OSCILLATORS

ASVM

Request Samples



Check Inventory



ESD Sensitive



7.0 x 5.0 x 0.85 mm  
RoHS/RoHS II Compliant  
MSL Level = 1

## Mechanical Dimensions

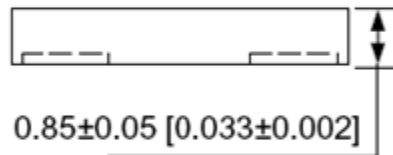
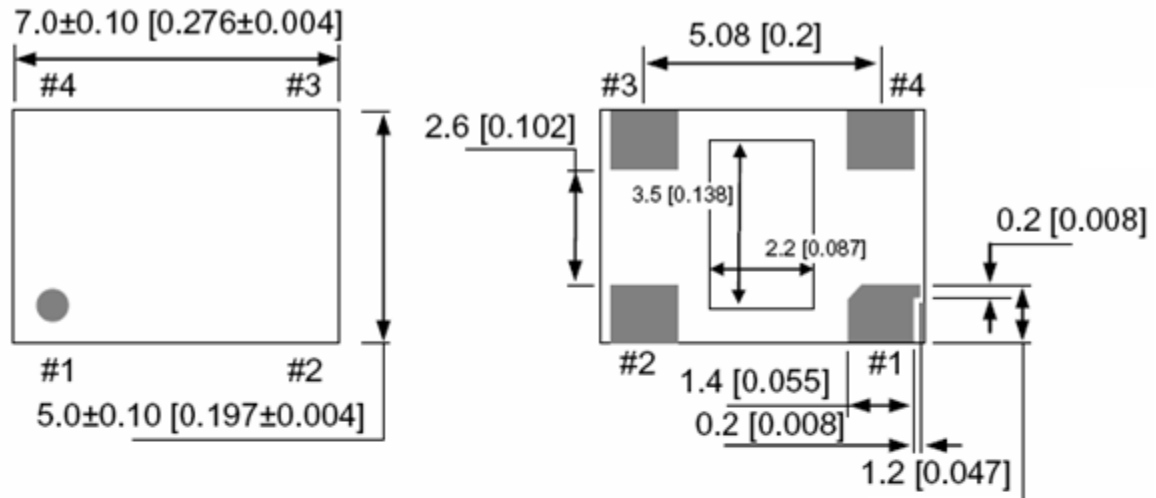

No.	Pin Terminal
1	Standby
2	GND
3	Output
4	VDD

Center Pad: NC/GND

## Recommended Land Pattern

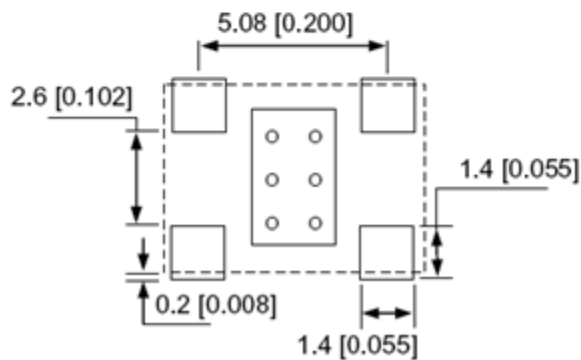

Note: Recommend using an approximately 0.01uF bypass capacitor between PIN 2 and 4.

Dimensions: mm (inches)



5101 Hidden Creek Ln Spicewood TX 78669  
Phone: 512-371-6159 | Fax: 512-351-8858  
For terms and conditions of sales, please visit:  
[www.abracon.com](http://www.abracon.com)

REVISED: 09-21-23

ABRACON IS  
ISO9001-2015  
CERTIFIED

# PLASTIC PACKAGE ULTRA MINIATURE PURE SILICON™ CLOCK OSCILLATORS

ASVM

Request Samples



Check Inventory



ESD Sensitive



7.0 x 5.0 x 0.85 mm  
RoHS/RoHS II Compliant  
MSL Level = 1

## Reflow Profile [JEDEC J-STD-020]

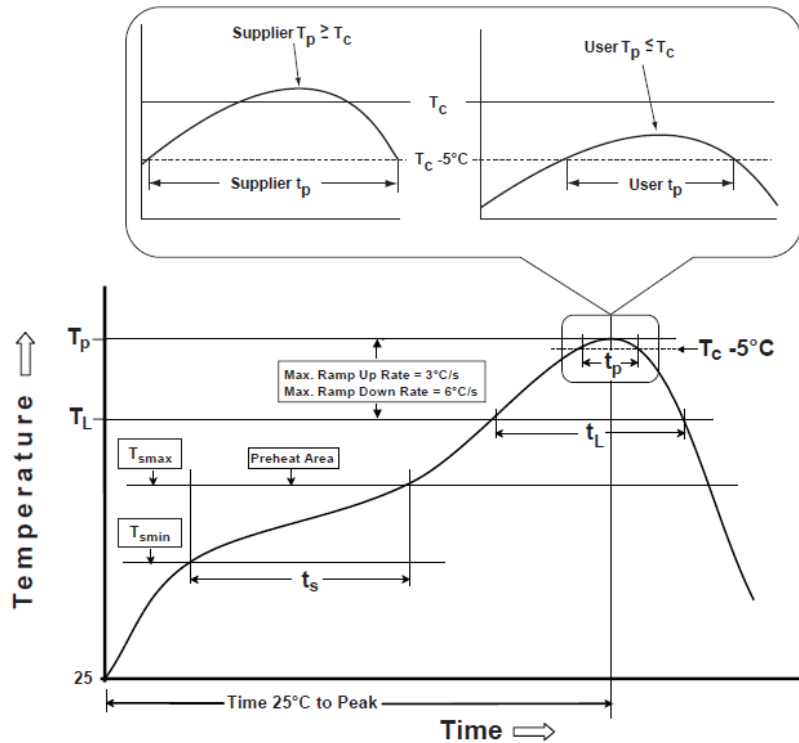

Table 1

SnPb Eutectic Process  
Classification Temperatures ( $T_c$ )

Package Thickness	Volume mm <sup>3</sup> <350	Volume mm <sup>3</sup> ≥350
<2.5 mm	235 °C	220 °C
≥2.5 mm	220 °C	220 °C

Table 2

Pb-Free Process  
Classification Temperatures ( $T_c$ )

Package Thickness	Volume mm <sup>3</sup> <350	Volume mm <sup>3</sup> 350-2000	Volume mm <sup>3</sup> >2000
<1.6 mm	260 °C	260 °C	260 °C
1.6 mm - 2.5 mm	260 °C	250 °C	245 °C
>2.5 mm	250 °C	245 °C	245 °C

Profile Feature	Sn-Pb Eutectic Assembly	Pb-Free Assembly
Preheat / soak		
Temperature minimum ( $T_{smin}$ )	100°C	150°C
Temperature maximum ( $T_{smax}$ )	150°C	200°C
Time ( $T_{smin}$ to $T_{smax}$ ) ( $t_s$ )	60 - 120 sec.	60 - 120 sec.
Average ramp-up rate ( $T_{smax}$ to $T_p$ )	3°C/sec. max	3°C/sec. max
Liquidous temperature ( $T_L$ )	183°C	217°C
Time at liquidous ( $t_L$ )	60 - 150 sec.	60 - 150 sec.
Peak package body temperature ( $T_p$ )*	see Table 1	see Table 2
Time ( $t_p$ )** within 5°C of the specified classification temperature ( $T_c$ )	20 sec.	30 sec.
Ramp-down rate ( $T_p$ to $T_{smax}$ )	6°C/sec. max	6°C/sec. max
Time 25°C to peak temperature	6 min. max	8 min. max
Reflow cycles	2 max	2 max

\*Tolerance for peak profile temperature ( $T_p$ ) is defined as a supplier minimum and a user maximum.

\*\*Tolerance for time at peak profile temperature ( $t_p$ ) is defined as supplier minimum and a user maximum.

# PLASTIC PACKAGE ULTRA MINIATURE PURE SILICON™ CLOCK OSCILLATORS

ASVM

Request Samples



Check Inventory



ESD Sensitive



7.0 x 5.0 x 0.85 mm  
RoHS/RoHS II Compliant  
MSL Level = 1

## Packaging

T= 1,000pcs/reel (D=180mm)

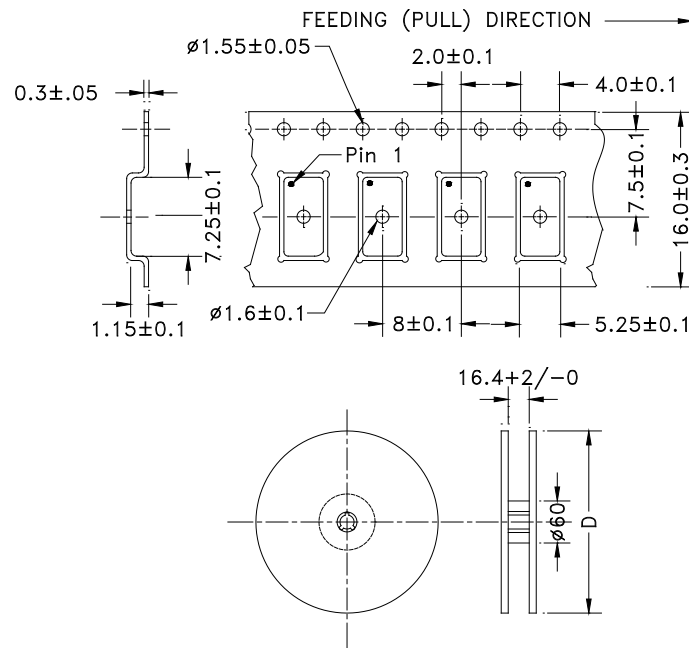

Tube: 50 pcs/tube

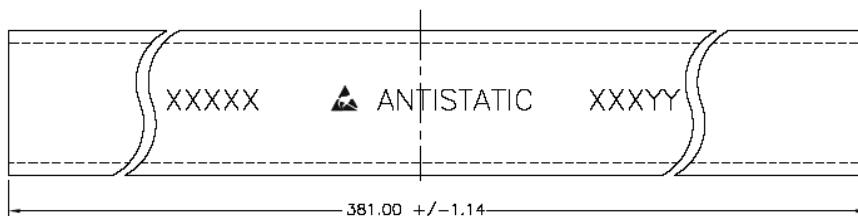

Unit orientation in tube:



Dimensions: mm

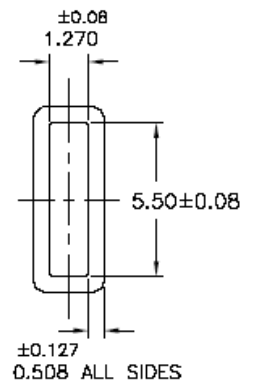

**ATTENTION:** Abracon LLC's products are COTS – Commercial-Off-The-Shelf products; suitable for Commercial, Industrial and, where designated, Automotive Applications. Abracon's products are not specifically designed for Military, Aviation, Aerospace, Life-dependent Medical applications or any application requiring high reliability where component failure could result in loss of life and/or property. For applications requiring high reliability and/or presenting an extreme operating environment, written consent and authorization from Abracon LLC is required. Please contact Abracon LLC for more information.



5101 Hidden Creek Ln Spicewood TX 78669  
Phone: 512-371-6159 | Fax: 512-351-8858  
For terms and conditions of sales, please visit:  
[www.abracon.com](http://www.abracon.com)

REVISED: 09-21-23

ABRACON IS  
ISO9001-2015  
CERTIFIED