

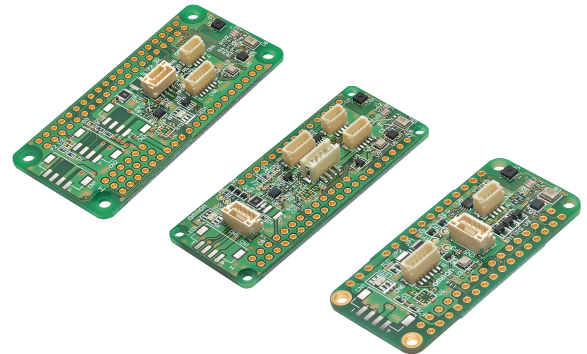

Sensor Evaluation Board 2JCIE-EV

Sensor evaluation board that supports open platform

- Easily implement development of a new IoT system that senses a wide variety of environmental information



 Refer to *Safety Precautions* on Page 9.

Features

Easily develop sensing IoT applications and PoC

- Evaluation board with six types of sensing functions.
- The product can be connected to a Raspberry Pi *1, Arduino *2, or Feather *3 baseboard, and enables easy sensor evaluation.
- The product can be connected to OMRON sensors (MEMS thermal sensor, MEMS flow sensor, Light convergent reflective sensor, air quality sensor, etc.) .

Six types of sensing functions

Temperature, humidity, light, barometric pressure, noise, acceleration

OMRON sensor evaluation board

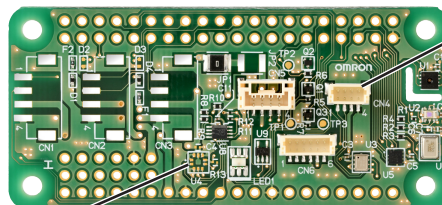

Can be connected to OMRON sensors *4



+

Platform

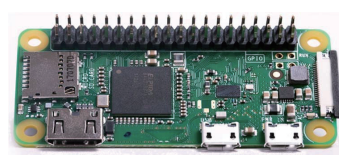

(Raspberry Pi)

Supports three platforms

Raspberry Pi *1, Arduino *2, Feather *3

+

Sample source code for acquiring sensor data is available on GitHub

- *1. Raspberry Pi is a registered trademark of the Raspberry Pi Foundation.
- *2. Arduino is a registered trademark of Arduino LLC and Arduino SRL.
- *3. Feather is a registered trademark of Adafruit Industries LLC.
- *4. For details, see External Expansion Sensor on page 3.

2JCIE-EV

Ordering Information

Unit

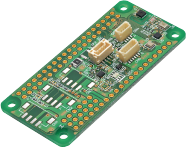
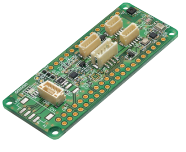
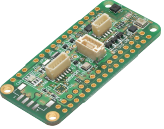
Type	Appearance	Model	Supported platform *4	
			Table of Models	
RP type		2JCIE-EV01-RP1	Raspberry Pi *1	3 A/1 B+/2 B/3 B/3 B+/Zero/Zero W *5
AR type		2JCIE-EV01-AR1	Arduino *2	MKR Vidor 4000/MKR WiFi 1010/MKR ZERO *5
FT type		2JCIE-EV01-FT1	Feather *3	HUZZAH32 *5

Supported Accessories (Sold Separately)

Type	Model
Cable harness	2JCIE-HARNESS-01
	2JCIE-HARNESS-02
	2JCIE-HARNESS-03
	2JCIE-HARNESS-04

*1. Raspberry Pi is a registered trademark of the Raspberry Pi Foundation.

*2. Arduino is a registered trademark of Arduino LLC and Arduino SRL.

*3. Feather is a registered trademark of Adafruit Industries LLC.

*4. Boards for supported platforms are not included.

*5. Do not use a model other than those listed in each table of platform supporting models.

Note: The temperature sensor on the sensor evaluation board may output a high value due to heat generated by the platform.

Ratings and Specifications

Specifications

Item	Model	2JCIE-EV01-RP1	2JCIE-EV01-AR1	2JCIE-EV01-FT1
Protocol		Pi HAT	Shield for MKR form factor	FeatherWing
Dimensions (mm)		Approx. 65 x 30	Approx. 61.5 x 25	Approx. 50.8 x 23.9
Sparkfun Qwiic (3.3 V I2C)		CN4	CN4	CN4
5V I ² C for expansion		CN5	CN5	CN5
		TH1	TH1	TH1
5V UART for expansion		CN6	CN6	CN6
5V DIO for expansion		---	CN7, CN8	TH2
Sensing data that can be acquired		Temperature, humidity, light, barometric pressure, noise, 3-axis acceleration		
Absolute maximum rating: Power voltage (5 V)		-0.2 to 5.5 V		
Absolute maximum rating: Power voltage (3.3 V)		-0.2 to 3.6 V		
Absolute maximum rating: Input/output terminal voltage (5 V)		-0.2 to 5.2 V		
Absolute maximum rating: Input/output terminal voltage (3.3 V)		-0.2 to 3.5 V		
Absolute maximum rating: Power current		700 mA		
Ambient storage temperature		-10 to 60°C (no condensation or icing)		
Ambient storage humidity		30 to 85% (no condensation or icing)		
Recommended operating range: Power voltage (5 V)		4.75 to 5.25 V		
Recommended operating range: Power voltage (3.3 V)		3.14 to 3.47 V		

Equipped Sensor

Part number *	Sensor	Model	Manufacturer	Interface
U1	Temperature/humidity sensor	SHT30-DIS-B	Sensirion	I ² C
U2	Ambient light sensor	OPT3001DNP	Texas Instruments	I ² C
U3	MEMS digital barometric pressure sensor	2SMPB-02E	OMRON	I ² C
U5	MEMS digital motion sensor	LIS2DW12	STMicroelectronics	SPI
U6	MEMS microphone	SPH0645LM4H-B	Knowles	I ² S

* For details, see the terminal layouts on pages 4 to 6.

Note: When using the sensor evaluation board, the accuracy indicated on the data sheet of each sensor manufacturer is not guaranteed.

External Expansion Sensor *1

Product	Manufacturer	Model	Supported connector *2			Supported accessories (sold separately)
			RP type	AR Type	FT type	
MEMS Thermal sensor		D6T-44L-06/-H		CN5		2JCIE-HARNESS-01
		D6T-8L-09/-H				
		D6T-1A-01				
		D6T-1A-02				
		D6T-32L-01A				
MEMS flow sensor	OMRON	D6F-PH0025AD1		CN4		2JCIE-HARNESS-02
		D6F-PH0505AD3				
		D6F-PH5050AD3				
		D6F-PH0025AD2				
		D6F-PH0505AD4		CN4		2JCIE-HARNESS-03
		D6F-PH5050AD4				
		D6F-PH0025AMD2				
		D6F-PH0505AMD4				
		D6F-PH5050AMD4				
		D6F-10A7D-000-0				
		D6F-20A7D-000-0				
		D6F-50A7D-000-0				
		D6F-70AB71D-000-0				
		D6F-70AB71D-000-0				
Light convergent reflective sensor		B5W-LB2101-1	---	CN8	TH2	2JCIE-HARNESS-04

Note: When an external expansion sensor is connected to the sensor evaluation board, the current supply ability of the platform board may be exceeded. Consider supplying power using an external power supply. Check current supply ability in the data sheet and other literature of each platform board. When using an external power supply, check the Jumper Function information and use jumper switching.

*1. We have checked the operation of typical models of each sensor.

*2. For details, see the terminal layouts on pages 4 to 6.

Software

Access the sample source code that supports each platform from the following URL.
(<https://www.components.omron.com/sensor/evaluation-board/2jcie>)

- Note:**
1. The sample source code is for evaluation. OMRON does not guarantee its operation.
 2. We bear no responsibility to correct mistakes or bugs in the sample source code for the purpose of changes or any other reason.
 3. We cannot accept any inquiries regarding the sample source code.

2JCIE-EV

Dimensions

(Unit: mm)

2JCIE-EV01-RP1

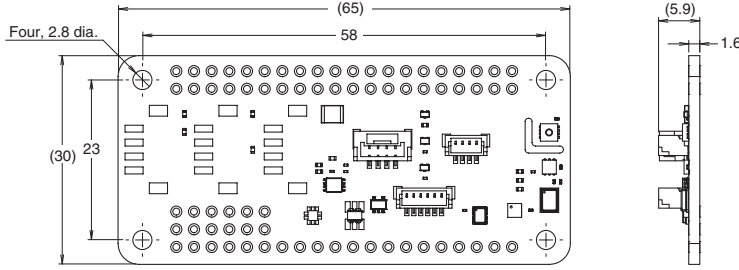

Connection

Terminal Arrangement

2JCIE-EV01-RP1

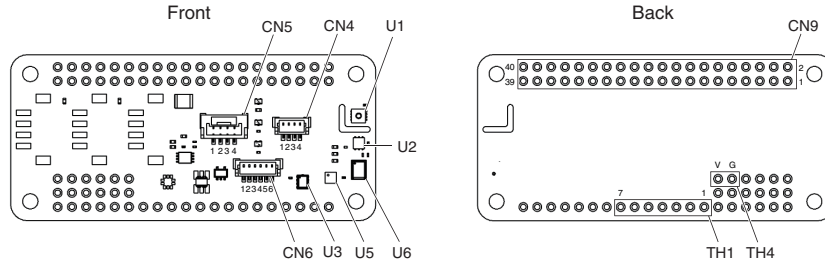

CN9	
1	3.3 VDC *1
2	5 VDC *2
3	SDA *1
4	NC
5	SCL *1
6	NC
7	NC
8	RXD *2
9	NC
10	TXD *2
11	DIGITAL4 *1
12	BCLK *1
13	RDY *2
14	NC
15	NC
16	DIGITAL1 *1
17	NC
18	DIGITAL2 *1
19	MOSI *1
20	GND
21	MISO *1
22	DIGITAL3 *1
23	SCLK *1
24	CS *1
25	NC
26	NC
27	NC
28	NC
29	EN *2
30	NC
31	LED_SW_R *2
32	LED_SW_G *2
33	LED_SW_B *2
34	NC
35	WS *1
36	INT *1
37	INT_LIS2DW12 *1
38	MIC_OUT *1
39	GND
40	NC

CN4 BM04B-SRSS-TB (JST)	
1	SCL
2	SDA
3	3.3 VDC
4	GND

CN5 BM04B-GHS-TB (JST)	
1	GND
2	5 VDC
3	SDA_5V
4	SCL_5V

CN6 BM06B-SRSS-TB (JST)	
1	5 VDC
2	RXD
3	TXD
4	GND
5	3.3 VDC
6	NC

TH1	
1	5 VDC
2	GND
3	SCL_5V
4	SDA_5V
5	RDY
6	NC
7	GND

TH4	
19	5 VDC (Ext.)
07	GND

*1. 3.3 V terminal *2. 5.0 V terminal

Block Diagram

2JCIE-EV01-RP1

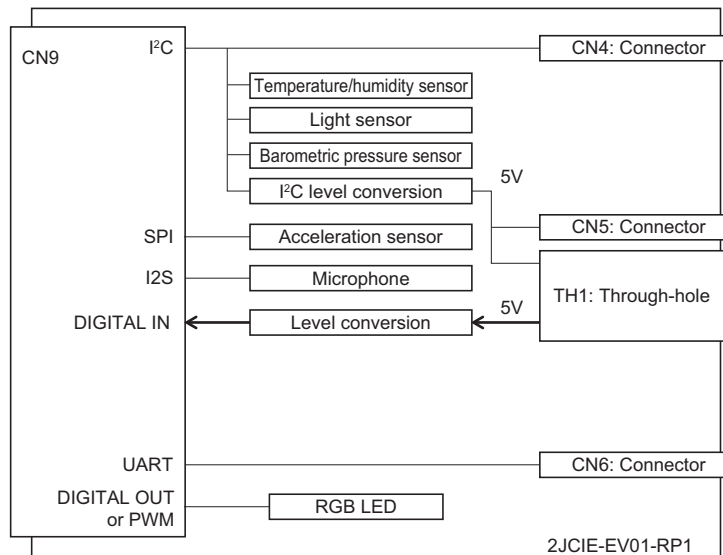

Dimensions

2JCIE-EV01-AR1

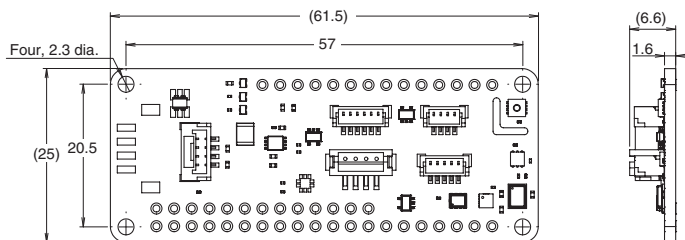

Connection

Terminal Arrangement

2JCIE-EV01-AR1

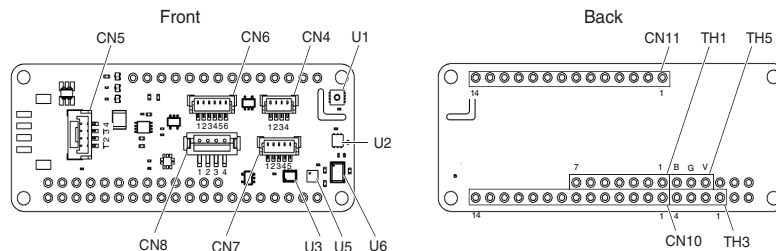

CN10	
1	NC
2	DAC *2
3	PMS_IN *2
4	B5WLA01_OUT *2
5	EN *2
6	B5WLA01_IN *2
7	PMS_OUT *2
8	MIC_OUT *1
9	CS *1
10	INT *1
11	BCLK *1
12	WS *1
13	LED_SW_R *2
14	LED_SW_G *2

CN11	
1	5 VDC *2
2	VBAT *1
3	3.3 VDC *1
4	GND
5	NC
6	RXD-B5W_OUT *2
7	TXD-B5W_OUT *2
8	SCL *1
9	SDA *1
10	MISO *1
11	SCLK *1
12	MOSI *1
13	NC
14	LED_SW_B *2

CN4 BM04B-SRSS-TB (JST)	
1	SCL
2	SDA
3	3.3 VDC
4	GND

CN6 BM06B-SRSS-TB (JST)	
1	5 VDC
2	RXD-B5W_OUT
3	TXD-B5W_OUT
4	GND
5	3.3 VDC
6	NC

CN5 BM04B-GHS-TB (JST)	
1	GND
2	5 VDC
3	SDA_5V
4	SCL_5V

CN7 BM05B-SRSS-TB (JST)	
1	5 VDC
2	TXD-B5W_OUT
3	GND
4	DAC
5	RXD-B5W_OUT

CN8 B4B-ZR-SM4-TF (JST)	
1	B5WLA01_IN
2	GND
3	B5WLA01_OUT
4	5 VDC

TH1	
1	5 VDC
2	GND
3	SCL_5V
4	SDA_5V
5	RXD-B5W_OUT
6	NC
7	GND

TH3	
1	5 VDC
2	PMS_IN
3	PMS_OUT
4	GND

TH5	
19	5 VDC (Ext.)
07	GND
B	VBAT

*1. 3.3 V terminal *2. 5.0 V terminal

Block Diagram

2JCIE-EV01-AR1

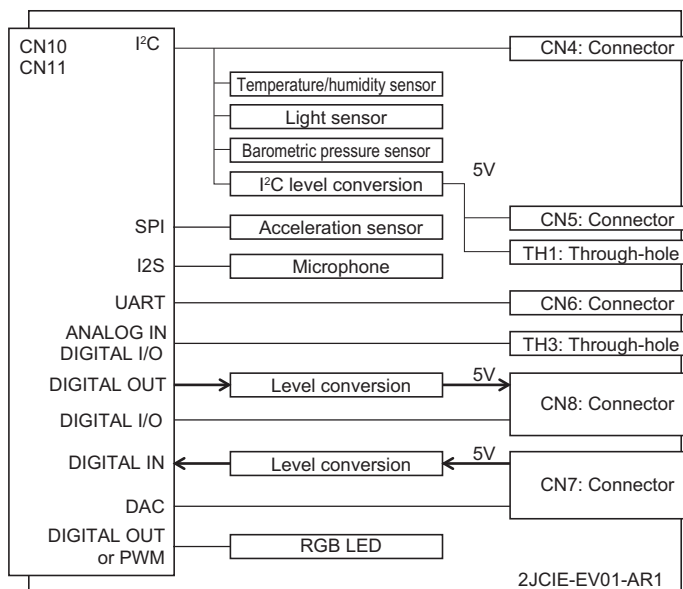

2JCIE-EV

Dimensions

(Unit: mm)

2JCIE-EV01-FT1

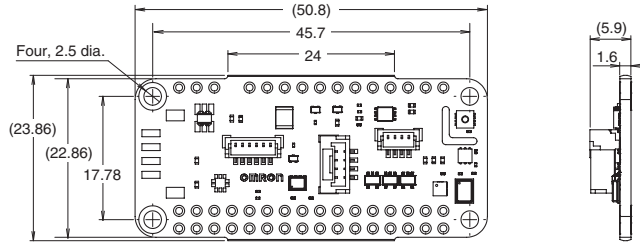

Connection

Terminal Arrangement

2JCIE-EV01-FT1

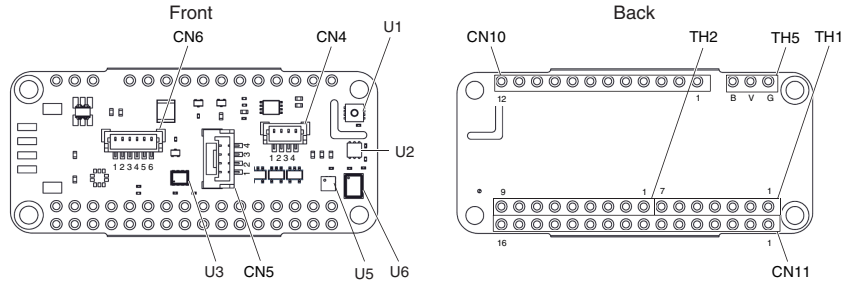

CN4 BM04B-SRSS-TB (JST)	
1	SCL
2	SDA
3	3.3 VDC
4	GND

CN5 BM04B-GHS-TB (JST)	
1	GND
2	5 VDC
3	SDA_5V
4	SCL_5V

CN11	
1	NC
2	3.3 VDC *1
3	NC
4	GND
5	DAC *2
6	LED_SW_B *2
7	INT *1
8	NC
9	PMS_IN *2
10	CS *1
11	SCLK *1
12	MOSI *1
13	MISO *1
14	TXD-B5W_OUT *2
15	RXD-B5W_OUT *2
16	EN *2

TH1	
1	5 VDC
2	GND
3	SCL_5V
4	SDA_5V
5	TXD-B5W_OUT
6	NC
7	GND

TH2	
1	5 VDC
2	DAC
3	RXD-B5W_OUT
4	TXD-B5W_OUT
5	B5WLA01_IN
6	PMS_B5WLA01_OUT
7	PMS_IN
8	PMS_B5WLA01_OUT
9	GND

CN6 BM06B-SRSS-TB (JST)	
1	5 VDC
2	RXD-B5W_OUT
3	TXD-B5W_OUT
4	GND
5	3.3 VDC
6	NC

CN10	
1	VBAT *1
2	NC
3	5 VDC *2
4	B5WLA01_IN *2
5	LED_SW_R *2
6	LED_SW_G *2
7	PMS_B5WLA01_OUT *2
8	WS *1
9	MIC_OUT1 *1
10	BCLK *1
11	SCL *1
12	SDA *1

TH5	
19	GND
07	5 VDC (Ext.)
B	VBAT

*1. 3.3 V terminal *2. 5.0 V terminal

Block Diagram

2JCIE-EV01-FT1

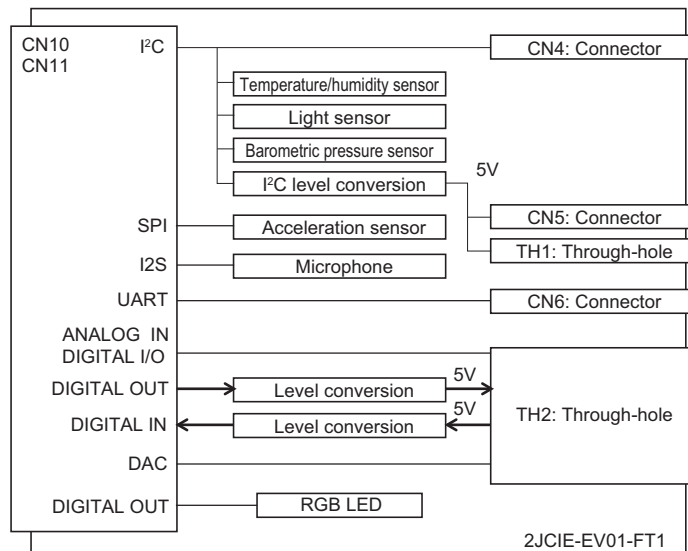

Dimensions

Cable harness (option) 2JCIE-HARNESS-01

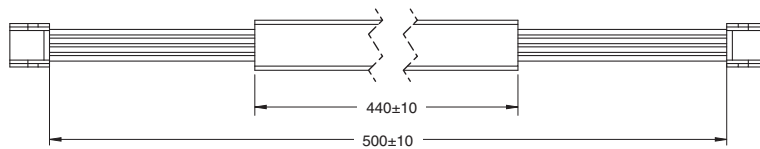

2JCIE-HARNESS-02

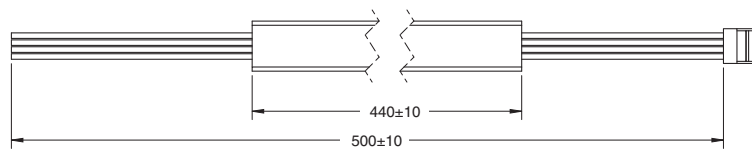

2JCIE-HARNESS-03

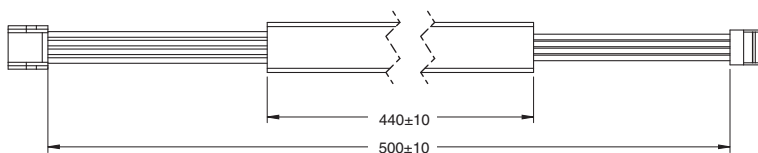

2JCIE-HARNESS-04

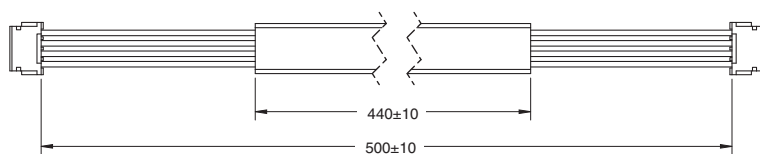

2JCIE-EV

Jumper Function (Power Related)

No.	Positions	Meaning	Application	Default	Status
JP1	Front	Zero-ohm resistance	When supplying power from the platform board	Connected	Enabled
JP2			When power is supplied from an external power supply or battery (Only the 2JCIE-EV01-AR1/FT1 supports batteries)	Open	Disabled

- When using an external power supply, remove the zero-ohm resistance from JP1 and connect the zero-ohm resistance to JP2 ((1) below). Connect the power of the external power supply to the V terminal in (2) below, and connect GND to G.
- (2JCIE-EV01-AR1/FT1 only) When using an external battery, connect the battery to B and GND to G. When using a battery, a 5 V input sensor cannot be used.
- When you switch to JP2, JP1 is disabled and power cannot be supplied from the platform board.
- Do not connect JP1 and JP2 at the same time.

How to switch by jumper

- Remove the zero-ohm resistance from JP1 by soldering arm and mount the JP2 by soldering. (Do not connect by soldering while connected to a base board or to an external power source)

2JCIE-EV01-FT1 Layout

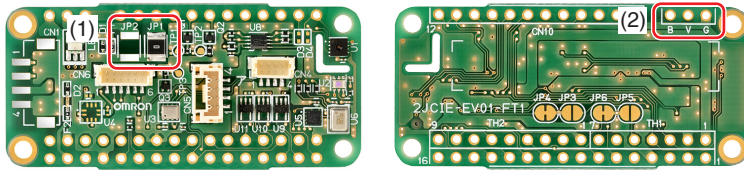

Jumper Function (Output Terminal)

No.	Positions	Meaning	Application	Default	Status
JP5	Back (2JCIE-EV01-AR1/FT1 only)	Switch by board pattern	For TH1 expansion	Open	Disabled
JP6			B5W digital output function	Connected	Enabled

When connected, the above function is enabled. When open, the above function is disabled. JP5 and JP6 are paired and cannot both be enabled.

How to switch by jumper

Cut the JP6 connection location (central part) with cutters, and connect the divided parts of JP5 by soldering.

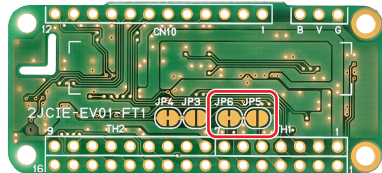

Note: Give full consideration to safety when cutting the jumper. OMRON cannot bear responsibility for any injury or damage that occurs.

Accessories

Type	Model
Pin socket for 2JCIE-EV01-RP1	ESQ-120-12-L-D (SAMTEC)
Pin header for 2JCIE-EV01-AR1	TSW-114-07-L-S (SAMTEC)
Pin socket for 2JCIE-EV01-FT1	ESQ-112-12-L-S (SAMTEC)
	ESQ-116-12-L-S (SAMTEC)

Note: To connect this board to the corresponding platform, it must be directly soldered or the pin header or socket must be soldered.

Safety Precautions

Precautions for safe use

Read the following to ensure safe use.

The safety precautions that are provided are extremely important to safety. Always read and heed the information provided in all safety precautions.

Explanation of safety symbols

⚠ CAUTION	Indicates a potentially hazardous situation which, if not avoided, may result in minor or moderate injury, or property damage.
Precautions for Safe Use	Precautions on what to do and what not to do to ensure safe usage of the product.
Precautions for Correct Use	Precautions on what to do and what not to do to ensure proper operation and performance.

⚠ CAUTION

- Do not incorporate this product in a product, regardless of the application.
- This product is not a measuring instrument. Do not use for purposes such as sensor output value measurement and diagnosis.
- When disposing of the product, follow local rules and regulations.

Precautions for Correct Use

- Keep out of the hands of small children when using and storing the product. If a small part is swallowed, immediately consult a physician.
- If you notice a strange odor or smoke coming from the product, or other abnormal condition, immediately shut off the power and consult your dealer.
- Do not handle this product with your bare hands. Risk of minor injury from the packaging box and edge of the board.
- Do not connect the indicated terminals or power not listed in this manual. Check the rating of each terminal, and do not use a current or voltage that exceeds the rating.
- This product is not waterproof. Do not use in an environment where water, oil, or chemicals may splash on the product. Do not wash with water or by ultrasound, and do not touch with wet hands.
- Do use an air blower. This may damage the sensor.
- Do not disassemble or modify the product.
- Do not grasp the product with excessive force, swing it around, or treat it roughly. Risk of product failure and injury.
- Do not use in an environment where corrosive, flammable, or explosive gases are present.

Precautions for Correct Use

- Treat the measured values acquired by this product as reference values.
- Do not connect this product to other than one of the models listed in each table of platform supporting models.
- The pin headers and sockets below are recommended for this product. For insertion/removal counts, refer to the latest data sheet / reliability test results for each pin header or socket.
 - 2JCIE-EV01-RP1: ESQ-120-12-L-D
 - 2JCIE-EV01-AR1: TSW-114-07-L-S
 - 2JCIE-EV01-FT1: ESQ-112-12-L-S
ESQ-116-12-L-S
- When this product is connected to any of the platforms, heat and other effects from the platform will cause the output of the product to change. Check these effects sufficiently before using the product
- Check, understand, and consider the installation location of each sensor before using the product. Do not use with the area around each sensor in a sealed state.
- This is a precision product. Exercise caution when handling. Dropping the packing box or the unit, or subjecting the unit and its terminals to intense shock may result in product failure.
- Do not use or store the product in a high-temperature or high-humidity location, a location exposed to long hours of direct sunlight, or in a vehicle. Sudden changes of ambient temperature may cause internal condensation that results in malfunctioning.
- Do not use or store in a location with dust, salt, or iron powder. Dust or other contaminants may collect in or on the product and cause failure.
- Do not use in a location with intense static electricity or electromagnetic waves. Risk of product failure.

Terms and Conditions Agreement

Read and understand this catalog.

Please read and understand this catalog before purchasing the products. Please consult your OMRON representative if you have any questions or comments.

Warranties.

- (a) Exclusive Warranty. Omron's exclusive warranty is that the Products will be free from defects in materials and workmanship for a period of a week from the date of sale by Omron (or such other period expressed in writing by Omron). Omron disclaims all other warranties, express or implied.
- (b) Limitations. OMRON MAKES NO WARRANTY OR REPRESENTATION, EXPRESS OR IMPLIED, ABOUT NON-INFRINGEMENT, MERCHANTABILITY OR FITNESS FOR A PARTICULAR PURPOSE OF THE PRODUCTS. BUYER ACKNOWLEDGES THAT IT ALONE HAS DETERMINED THAT THE PRODUCTS WILL SUITABLY MEET THE REQUIREMENTS OF THEIR INTENDED USE.

Omron further disclaims all warranties and responsibility of any type for claims or expenses based on infringement by the Products or otherwise of any intellectual property right. (c) Buyer Remedy. Omron's sole obligation hereunder shall be, at Omron's election, to (i) replace (in the form originally shipped with Buyer responsible for labor charges for removal or replacement thereof) the non-complying Product, (ii) repair the non-complying Product, or (iii) repay or credit Buyer an amount equal to the purchase price of the non-complying Product; provided that in no event shall Omron be responsible for warranty, repair, indemnity or any other claims or expenses regarding the Products unless Omron's analysis confirms that the Products were properly handled, stored, installed and maintained and not subject to contamination, abuse, misuse or inappropriate modification. Return of any Products by Buyer must be approved in writing by Omron before shipment. Omron Companies shall not be liable for the suitability or unsuitability or the results from the use of Products in combination with any electrical or electronic components, circuits, system assemblies or any other materials or substances or environments. Any advice, recommendations or information given orally or in writing, are not to be construed as an amendment or addition to the above warranty.

See <http://www.omron.com/global/> or contact your Omron representative for published information.

Limitation on Liability; Etc.

OMRON COMPANIES SHALL NOT BE LIABLE FOR SPECIAL, INDIRECT, INCIDENTAL, OR CONSEQUENTIAL DAMAGES, LOSS OF PROFITS OR PRODUCTION OR COMMERCIAL LOSS IN ANY WAY CONNECTED WITH THE PRODUCTS, WHETHER SUCH CLAIM IS BASED IN CONTRACT, WARRANTY, NEGLIGENCE OR STRICT LIABILITY.

Further, in no event shall liability of Omron Companies exceed the individual price of the Product on which liability is asserted.

Suitability of Use.

Omron Companies shall not be responsible for conformity with any standards, codes or regulations which apply to the combination of the Product in the Buyer's application or use of the Product. At Buyer's request, Omron will provide applicable third party certification documents identifying ratings and limitations of use which apply to the Product. This information by itself is not sufficient for a complete determination of the suitability of the Product in combination with the end product, machine, system, or other application or use. Buyer shall be solely responsible for determining appropriateness of the particular Product with respect to Buyer's application, product or system. Buyer shall take application responsibility in all cases.

NEVER USE THE PRODUCT FOR AN APPLICATION INVOLVING SERIOUS RISK TO LIFE OR PROPERTY OR IN LARGE QUANTITIES WITHOUT ENSURING THAT THE SYSTEM AS A WHOLE HAS BEEN DESIGNED TO ADDRESS THE RISKS, AND THAT THE OMRON PRODUCT(S) IS PROPERLY RATED AND INSTALLED FOR THE INTENDED USE WITHIN THE OVERALL EQUIPMENT OR SYSTEM.

Programmable Products.

Omron Companies shall not be responsible for the user's programming of a programmable Product, or any consequence thereof.

Performance Data.

Data presented in Omron Company websites, catalogs and other materials is provided as a guide for the user in determining suitability and does not constitute a warranty. It may represent the result of Omron's test conditions, and the user must correlate it to actual application requirements. Actual performance is subject to the Omron's Warranty and Limitations of Liability.

Change in Specifications.

Product specifications and accessories may be changed at any time based on improvements and other reasons. It is our practice to change part numbers when published ratings or features are changed, or when significant construction changes are made. However, some specifications of the Product may be changed without any notice. When in doubt, special part numbers may be assigned to fix or establish key specifications for your application. Please consult with your Omron's representative at any time to confirm actual specifications of purchased Product.

Errors and Omissions.

Information presented by Omron Companies has been checked and is believed to be accurate; however, no responsibility is assumed for clerical, typographical or proofreading errors or omissions.

Please check each region's Terms & Conditions by region website.

OMRON Corporation

Device & Module Solutions Company

Regional Contact

Americas

<https://components.omron.com/us>

Asia-Pacific

<https://components.omron.com/ap>

Korea

<https://components.omron.com/kr>

Europe

<https://components.omron.com/eu>

China

<https://components.omron.com.cn>

Japan

<https://components.omron.com/jp>