

Round Connectors 1-pole, uninsulated

Power transmission and distribution | Single-pole industrial connectors EN



STÄUBLI ELECTRICAL CONNECTORS

Connections for Life



Stäubli, as the international technology leader, offers innovative mechatronics solutions in its four divisions: Electrical Connectors, Fluid Connectors, Robotics, and Textile. At Stäubli Electrical Connectors, we develop advanced connection solutions based on the reliable MULTILAM contact technology.

Together for reliable and safe connections

We know that you entrust us with the functionality of your applications and we work hard to ensure this every single day. Thanks to our high level of expertise, our extensive experience and the multiple successful co-operation with our partners, numerous new developments have originated at Stäubli Electrical Connectors and subsequently have become worldwide standards. This includes our MC4 connector portfolio for which we are today the global market

We create connections for life – and our customers are at the center of these connections. We are convinced that solid and stable partnerships directly contribute to our mutual success.

We take on the needs of our partners and deal with the most extraordinary challenges. As a result, we always create, sell and

support reliable and long-lasting products for markets with the highest productivity and safety requirements in close cooperation with our customers.

leader in photovoltaic. As the Stäubli original, the MC4 represents the result of our constant quest for innovation, quality and safety.

Further examples are the CombiTac modular connector system or the Quick Charging Connector (QCC) for automatic charging systems.

We ensure connections for life together with our long-standing customers in a wide range of industries from renewable energies, power transmission and distribution and E-mobility to industrial automation applica-

tions, railway and welding automation, test and measurement and medical devices.

Thus, developing reliable, efficient and safe solutions based on our proven MULTILAM contact technology, which guarantees a high service lifetime in addition to highly efficient power transmission.

Application and advantages



Stäubli uninsulated, single-pole round connectors are optimally suitable for efficient connecting solutions. We offer a broad range of plugs and sockets for various application areas. Those include the power industry, switchgears, busbar connections, manufacturing systems, test benches, cable coupling and many other industrial applications.

Thanks to the unique and tested MULTILAM Technology, Stäubli connectors guarantee high lifetime and reliability in applications with demanding requirements.

To meet our customers' demands, Stäubli offers standard as well as 100% customized solutions that feature:

- High rated current and short circuit carrying capacity
- Very low contact resistance and contact heating
- High resistance to vibration, shock and impact
- High mating cycles
- High resistance to oils, insulating gases, vacuum and low temperature

Contents

Page 7	Introduction	Page 28	Plugs with snap-in lock <ul style="list-style-type: none">• With thread termination S...AR-N• With crimp termination SP...AR-N• With internal thread termination SIG...AR-N
Page 8	Connectors with AxiClamp termination <ul style="list-style-type: none">• Round connectors and cable connectors Ø 8 mm, Ø 12 mm, Ø 16 mm, Ø 20 mm• Cable connectors with AxiClamp termination	Page 31	Accessories <ul style="list-style-type: none">• Crimping sleeves• Reducing sleeves• Nuts, Washers, Serrated lock washers
Page 12	Sockets <ul style="list-style-type: none">• With thread termination B...N• With external thread termination BL...N• With external MULTILAM BL...A	Page 36	What is AxiClamp? <ul style="list-style-type: none">• The patented lead connecting system
Page 18	Plugs <ul style="list-style-type: none">• With thread termination S...N• with crimp termination SP...N	Page 37	Appendix <ul style="list-style-type: none">• Stäubli recommended crimping pliers• Derating diagrams• Technical information• Safety notes• Table of contents
Page 23	Stäubli Locking system (AR-System)		
Page 24	Sockets with snap-in lock <ul style="list-style-type: none">• With thread termination B...AR-N• With crimp termination BP...AR-N		

General information

Colour code

For items available in various colours, replace the asterisk "*" with the appropriate colour code.

20	green-yellow	26	violet
21	black	27	brown
22	red	28	grey
23	blue	29	white
24	yellow	33	transparent
25	green		

Changes/Provisos

All data, illustrations and drawings in the catalogue have been carefully checked. They are in accordance with our experience to date, but no responsibility can be accepted for errors.

We also reserve the right to make modifications for design and safety reasons. When designing equipment incorporating our components, it is therefore advisable not to rely solely on the data in the catalogue but to consult us to make sure this information is up to date. We shall be pleased to advise you.

Copyright

The use of this catalogue for any other purpose, in whatever form, without our prior written consent is not permitted.

RoHSready

Directive 2002/95/EC on the restriction of the use of certain hazardous substances in electrical and electronic equipment

Symbols



Accessories or special tools exist for this product



Before use, please read the enclosed user information i000.



The assembly instruction MA000 is available for this product

UNLIMITED POSSIBILITIES FOR CONTACT SOLUTIONS

MULTILAM Technology



MULTILAM are specially formed and resilient contact elements. All Stäubli Electrical Connectors products benefit from the unique and outstanding performance of the **MULTILAM Technology**.

Thanks to their constant spring pressure, MULTILAM louvers ensure continuous contact with the contact surface, resulting in a constantly low contact resistance.

MULTILAM Technology allows to find solutions for connectors within the severest constraints and in certain products for up to 1 million mating cycles.

This makes the MULTILAM Technology the best choice for applications with demanding requirements:

- Reliable and longlife operation due to constantly high performance
- Safe operation under highest environmental demands on temperature, vibration and shock
- Suitable for data and signal contacts as well as high-current connectors
- Automated solutions with a high number of mating cycles



INTRODUCTION

Single-pole round connectors, uninsulated

The standard plug connections are made of brass (crimping sleeve is copper) and are silver plated approx. 6µm. Special connections with other dimensions or materials as well as special silver plating for a higher plugging frequency, are available on request.

Attention: Before initial use, all threads and mating sliding surfaces of contact parts should be covered with a thin lubrication film (see page 40, Lubricant).

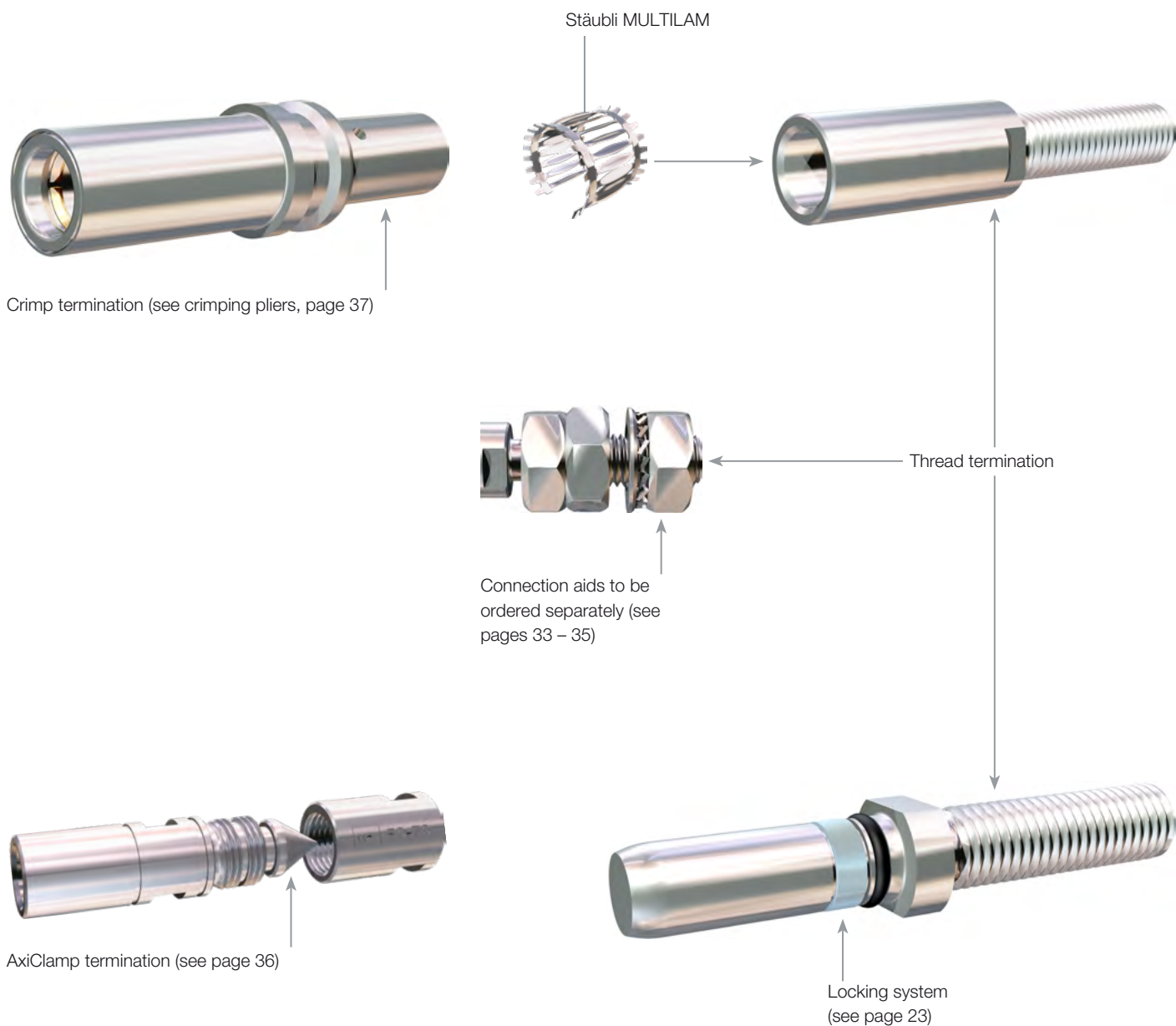

CONNECTORS WITH AXICLAMP TERMINATION

Round connectors with AxiClamp¹⁾ termination

Everywhere applicable where on fast and simple way a pluggable electrical connection is required.

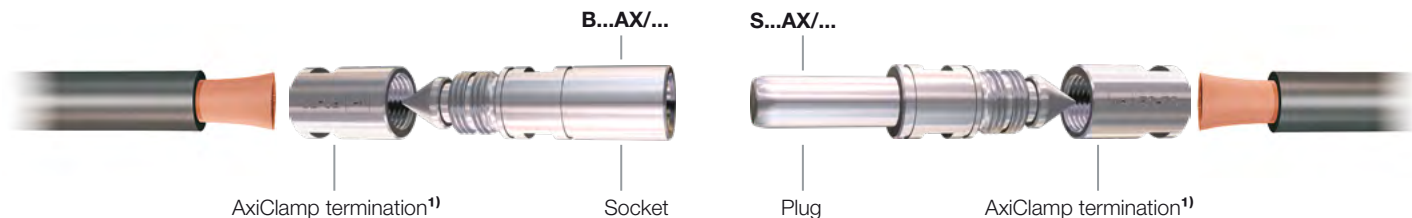

Grooves for circlips for panel mounting

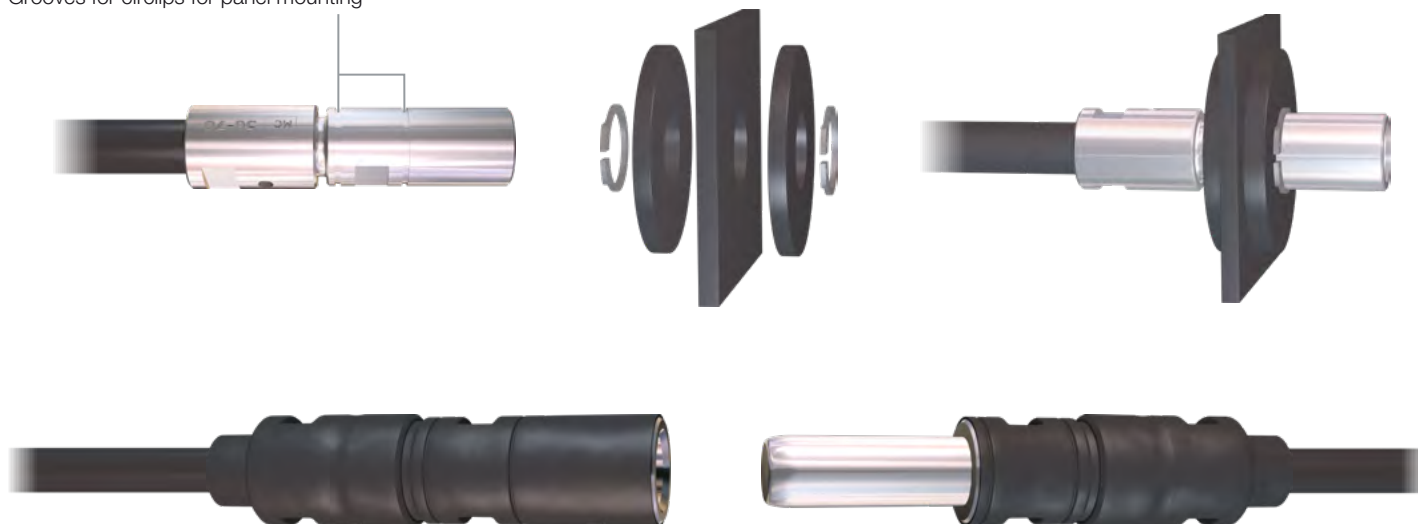

With a form shroud tubing the connection can be insulated

	4 sizes can be supplied ²⁾		
150 mm ² – 185 mm ²		Ø 20	
95 mm ² – 120 mm ²		Ø 16	
50 mm ² – 70 mm ²		Ø 12	
25 mm ² – 35 mm ²		Ø 8	

¹⁾ See page 36, what is AxiClamp?

²⁾ Bigger sizes up to 300 mm², on request

Order No.	Type	Dimensions (mm)									Withdrawal force	Rated current ¹⁾	Contact resistance	Short-circuit current (1s) ²⁾	Short-circuit current (3s) ²⁾	Rated peak withstand current
		SW1	SW2	A	B	C	D	Ø E	Ø F	Ø G						
01.0020	B8AX/25-35	12	12	67.5	42	24.5	-	14	-	15	20	130	60	4.5	3	17
01.0021	B12AX/50-70	15	16	72	42	29	-	18	-	19.4	30	230	40	7	5.5	25
01.0022	B16AX/95-120	19	22	88	48	39	-	22	-	26	65	350	25	13.5	10	40
01.0023	B20AX/150-185	24	27	97	52	44	-	28	-	32	80	450	15	17	12.5	50
04.0020	S8AX/25-35	12	12	75.3	34	15.8	24.5	8	14	15	20	130	60	4.5	3	17
04.0021	S12AX/50-70	15	16	84.4	34	20.4	29	12	18	19.4	30	230	40	7	5.5	25
04.0022	S16AX/95-120	19	22	101.4	38	23.4	39	16	22	26	65	350	25	13.5	10	40
04.0023	S20AX/150-185	24	27	113.8	42	26.8	44	20	28	32	80	450	15	17	12.5	50

B...AX/...

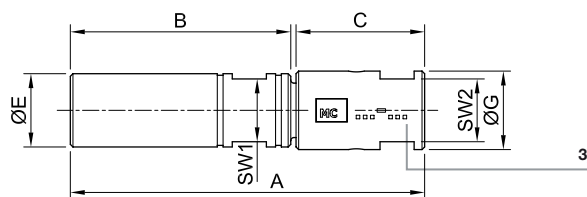

S...AX/...

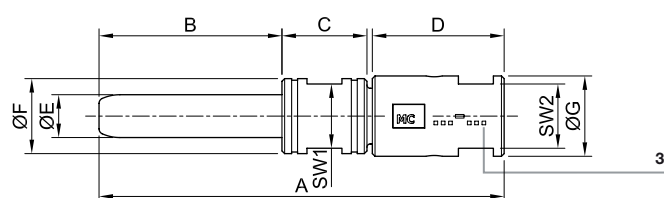

AxiClamp terminations

Type	Conductor cross section	AWG	Max. Ø strand	Max. cable-Ø	Stripping length	Tightening torque
	mm ²		mm	mm	mm	Nm
...AX/25-35	25 – 35	2	0.51	8.5	15	24
...AX/50-70	50 – 70	1; 1/0; 2/0	0.51	12.5	19	45
...AX/95-120	95 – 120	3/0; 4/0	0.51	16	26	78
...AX/150-185	150 – 185	5/0; 6/0	0.51	20	32	120

¹⁾ The rated current value depend also on the used conductor cross section.

²⁾ R.m.s. value

³⁾ On this place the respective range of the conductor cross section ist engraved.

Cable connectors with AxiClamp¹⁾ termination

Everywhere applicable where on fast and simple way a cable connection is required e.g. for broken cables or for cable extensions.

AX-BI...



AxiClamp terminations¹⁾



AxiClamp termination with turnable ring, prevents rotation during screw clamping.

4 sizes can be supplied²⁾

150 mm² – 185 mm²



Ø 20

150 mm² – 185 mm²

95 mm² – 120 mm²



Ø 16

95 mm² – 120 mm²

50 mm² – 70 mm²



Ø 12

50 mm² – 70 mm²

25 mm² – 35 mm²



Ø 8

25 mm² – 35 mm²

¹⁾ See page 36, what is AxiClamp?

²⁾ Bigger sizes up to 300 mm², on request

Order No.	Type	Dimensions (mm)							Rated current ¹⁾	Short-circuit current (1s) ²⁾	Short-circuit current (3s) ²⁾	Rated peak withstand current
		SW1	SW2	A	B	C	Ø F	Ø G				
07.1001	AX-BI/25-35	12	17	63.3	24.5	24.5	15	20	130	4.5	3	17
07.1002	AX-BI/50-70	16	21	71.3	29	29	19.4	24	230	7	5.5	25
07.1003	AX-BI/95-120	22	24	93.3	39	39	26	29	350	13.5	10	40
07.1004	AX-BI/150-185	27	34	108	44	44	32	40	450	17	12.5	50

AX-BI/...

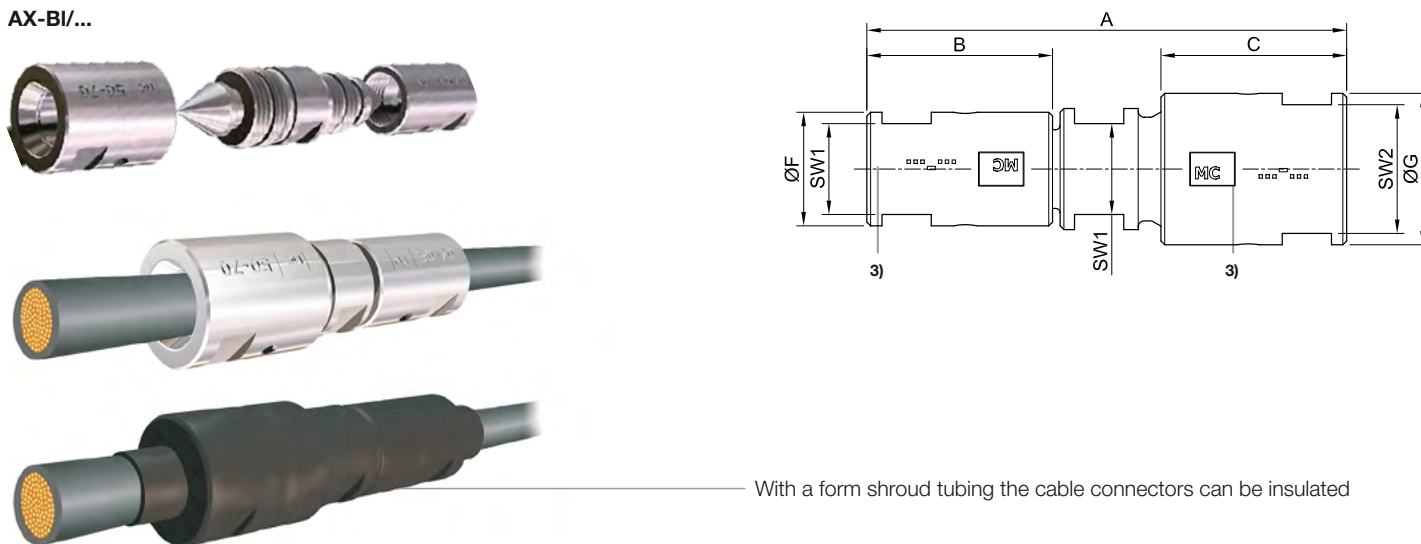

Note:

Technical data for AxiClamp terminations, see page 9.

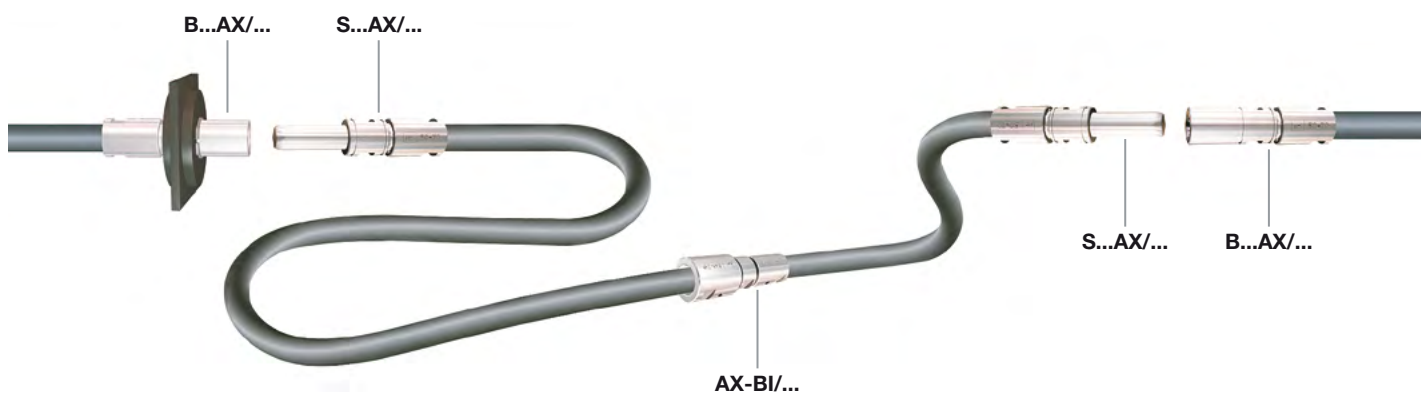

¹⁾ The rated current value depend also on the used conductor cross section.

²⁾ R.m.s. value

³⁾ On this place the respective range of the conductor cross section ist engraved.

SOCKETS

Sockets B...N with thread termination

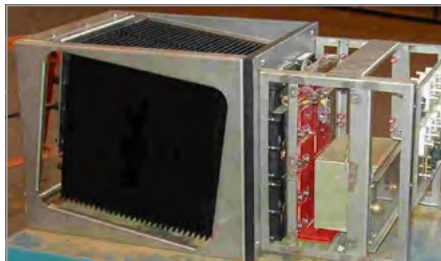

B...N sockets in a slide-in unit

B2N-B6N

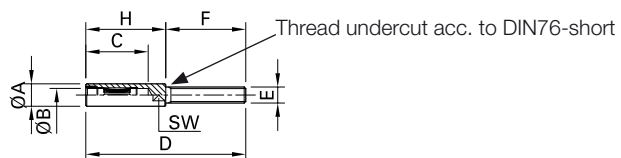

B8N-B10N

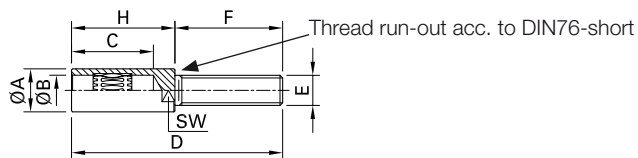

B12N-B20N

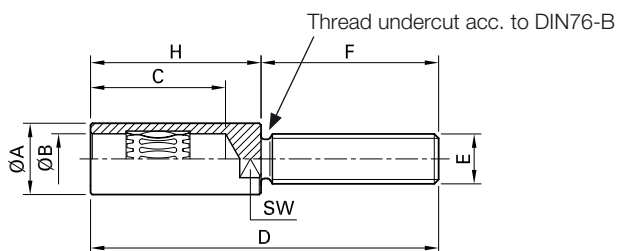

B25N-B40N

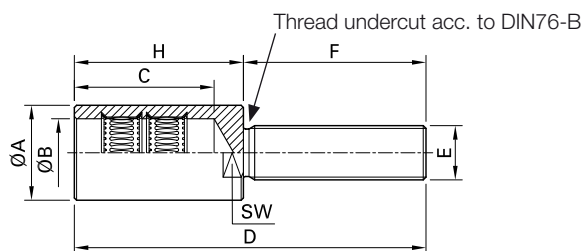

Crimping sleeves H...N/M... to change the thread termination to a crimp termination, see page 31.



Matching parts S...N page 18

Matching parts SP...N page 20

Connection aids page 33-35

Termination examples



Cable lug

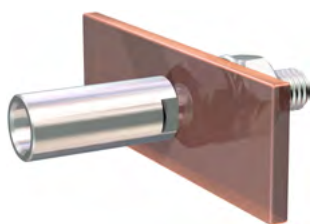

Busbar

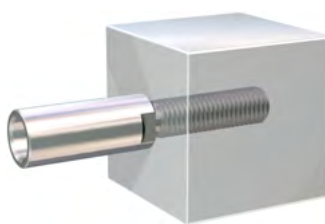

Contact bloc

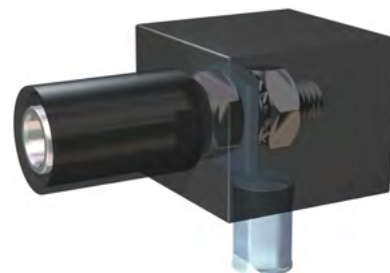

Insulated housing

Order No.	Type	MULTILAM	Dimensions (mm)								Withdrawal force	Insertion force	Tightening torque	Weight	Rated current (80 °C) ¹⁾	Rated current (150 °C) ¹⁾	Contact resistance	Short-circuit current (1s) ²⁾	Short-circuit current (3s) ²⁾	Rated peak withstand current
			Ø A	Ø B	C	D	E	F	H	SW										
01.0001	B2N	LAI	5.5	2	16.5	36	M3	16	20	4	6	8	0.5	0.004	35	50	300	0.5	0.4	2
01.0002	B3N	LAI	6	3	16.5	40	M4	20	20	5	8	10	1.2	0.005	40	55	200	0.8	0.65	3
01.0003	B4N	LAI	7	4	19.5	50	M5	25	25	6	15	22	2.0	0.009	65	90	200	1.2	0.9	4
01.0004	B5N	LAI	8.5	5	19.5	50	M5	25	25	7	15	22	2.0	0.011	70	100	150	1.5	1	5.5
01.0005	B6N	LAI	10	6	19.5	53	M6	28	25	8	20	25	3.0	0.015	100	180	100	2.5	1.5	8
01.0006	B8N	LAI	14	8	34	78	M8	36	42	11	20	25	6.0	0.047	130	240	60	4.5	3	17
01.0007	B10N	LAI	16	10	34	84	M10	42	42	13	30	35	10	0.066	200	350	50	5.5	4	20
01.0008	B12N	LAI	18	12	34	90	M12	48	42	13	30	35	16	0.087	230	420	40	7	5.5	25
01.0009	B14N	LAI	20	14	38	98	M14	50	48	17	45	50	22	0.121	300	500	35	11.5	8	35
01.0010	B16N	LAI	22	16	38	106	M16	58	48	19	65	70	30	0.160	350	540	25	13.5	10	40
01.0011	B18N	LAI	25	18	42	110	M16	58	52	22	75	100	30	0.193	400	640	20	15	11	45
01.0012	B20N	LAI	28	20	42	122	M18	70	52	24	80	120	40	0.265	500	760	15	17	12.5	50
01.0013	B25N	2LAI	38	25	62	149	M20	74	75	32	80	120	52	0.588	700	1100	10	27	20	100
01.0014	B30N	2LAI	42	30	62	156	M24x2	81	75	36	100	120	80	0.726	900	1500	9	35	25	120
01.0015	B35N	2LAI	48	35	62	165	M30x2	90	75	41	120	150	150	1.057	1200	2000	8	40	30	140
01.0016	B40N	2LAI	52	40	62	180	M36x3	105	75	46	120	150	250	1.400	1500	2200	7	45	35	160

¹⁾ End temperature

²⁾ r.m.s. value

Sockets BL...N with external thread

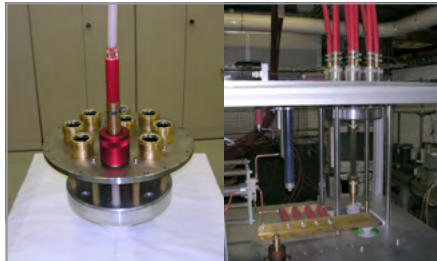

BL...N sockets for plug-in high current connection

BL2N-BL6N

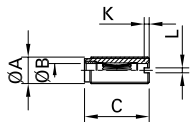

BL8N-BL20N

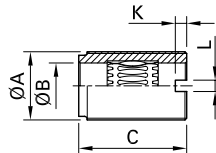

BL25N-BL50N

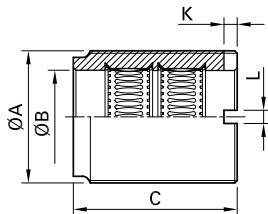

BL60N-BL100N

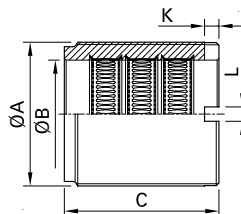

The BL-sockets with external thread must be screwed against a fixed stop, or screwed into the busbar with 2 nuts and washers. For

extreme loads and mounting conditions and where a stop is not possible, a socket with

external MULTILAM instead of a thread is available (see BL...A pages 16-17).



Matching parts S...N page 18

Matching parts SP...N page 20

Connection aids pages 33-35

Termination examples



Busbar

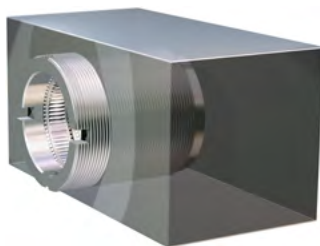

Contact block (with stop)

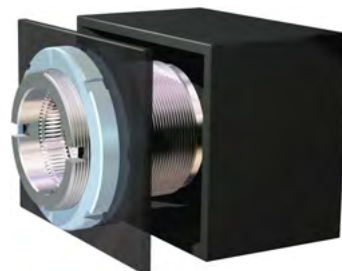

Insulated housing

Order No.	Type	MULTILAM	Dimensions (mm)					Withdrawal force	Insertion force	Tightening torque	Weight	Rated current (80 °C) ¹⁾	Rated current (150 °C) ¹⁾	Contact resistance	Short-circuit current (1s) ²⁾	Short-circuit current (3s) ²⁾	Rated peak withstand current
			Ø A	Ø B	C	K	L										
02.0001	BL2N	LAI	M8x0.75	2	16.5	1.5	1.5	6	8	2.5	0.005	35	50	300	0.5	0.4	2
02.0002	BL3N	LAI	M8x0.75	3	16.5	1.5	1.5	8	10	2.5	0.005	40	55	200	0.6	0.65	3
02.0003	BL4N	LAI	M8x0.75	4	19.5	1.5	1.5	15	22	2.5	0.005	65	90	200	1.2	0.9	4
02.0004	BL5N	LAI	M10x1	5	19.5	2	1.5	15	22	5	0.007	70	100	150	1.5	1	5.5
02.0005	BL6N	LAI	M12x1	6	19.5	2.5	2	20	25	10	0.011	100	180	100	2.5	1.5	8
02.0201	BL6AR-N ³⁾	LAI	M14x1	6	28	1.5	2	25	30	13	0.023	100		100	2.5	1.5	8
02.0006	BL8N	LAI	M14x1	8	34	2.5	2.5	20	25	13	0.021	130	240	60	4.5	3	17
02.0007	BL10N	LAI	M18x1	10	34	3.5	3.5	30	35	22	0.039	200	350	50	5.5	4	20
02.0008	BL12N	LAI	M20x1	12	34	3.5	3.5	30	35	30	0.043	230	420	40	7.0	5.5	25
02.0009	BL14N	LAI	M22x1	14	38	4	4	45	50	35	0.057	300	500	35	11.5	8	35
02.0010	BL16N	LAI	M24x1	16	38	4	4	65	70	35	0.063	350	540	25	13.5	10	40
02.0011	BL18N	LAI	M28x1	18	42	4	4	75	100	55	0.105	400	640	20	15	11	45
02.0012	BL20N	LAI	M30x1	20	42	4	5	80	120	65	0.114	500	760	15	17	12	50
02.0013	BL25N	2LAI	M42x1.5	25	62	5	5	80	120	150	0.394	700	1100	10	27	20	100
02.0014	BL30N	2LAI	M48x1.5	30	62	5	5	100	120	200	0.486	900	1500	9	35	25	120
02.0015	BL35N	2LAI	M50x1.5	35	62	5	5	120	150	220	0.427	1200	2000	8	40	30	140
02.0016	BL40N	2LAI	M55x1.5	40	62	6	6	120	150	275	0.472	1500	2200	7	45	35	160
02.0017	BL45N	2LAI	M60x2	45	62	6	6	120	150	430	0.502	1800	2500	7	50	40	175
02.0018	BL50N	2LAI	M65x2	50	62	8	7	130	150	500	0.558	2000	2800	6	55	45	195
02.0019	BL60N	3LAI	M80x2	60	86	8	8	300	350	750	1.357	3000	4000	6	70	55	320
02.0020	BL70N	3LAI	M90x2	70	86	8	8	400	450	1000	1.546	3700	4500	6	90	70	400
02.0021	BL80N	3LAI	M100x2	80	86	8	8	500	540	1500	1.702	4200	5400	5	110	80	450
02.0022	BL90N ⁴⁾	3LAI	M110x2	90	86	8	8	550	600	2000	1.873	4500	5800	5	130	110	500
02.0023	BL100N ⁴⁾	3LAI	M120x2	100	86	8	8	630	670	2500	2.094	5000	6300	5	150	120	550

Note:

Before assembly the threads must be covered with a thin lubricating film (see page 40 Lubricant).

¹⁾ End temperature

²⁾ r.m.s. value

³⁾ With locking system

⁴⁾ Only on request, not in stock



Assembly instructions MA021

www.staubli.com/electrical

Sockets BL...A with external MULTILAM



BL...A socket in a contact block pressed-in as a plug connection

BL25A-BL45A

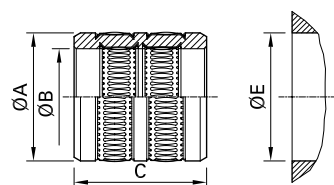

BL60A-BL70A

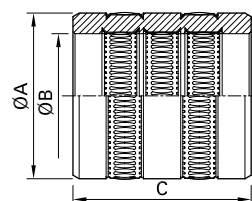

The holes should be silver-plated for an optimum contact. However, it is possible to make contact with unplated materi-

als (also alloy aluminium, e.g. AlMgSi0.5, EN-AW 6060) in a non corrosive atmosphere when the contact surfaces are covered with

grease and are kept free from oxidation and humidity (see page 40, Lubricant).



Matching parts S...N pages 18-19

Termination examples

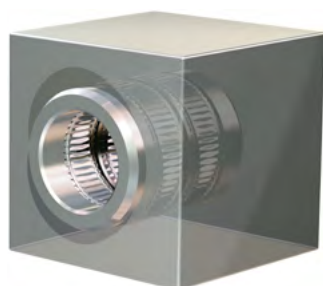

Contact block



Tube connector

Order No.	Type	MULTILAM	Dimensions (mm)				Withdrawal force	Insertion force	Max. Assembling force	Weight	Rated current (80 °C) ¹⁾	Rated current (150 °C) ¹⁾	Contact resistance	Short-circuit current (1s) ²⁾	Short-circuit current (3s) ²⁾	Rated peak withstand current
			Ø A	Ø B	C	Ø E										
02.0525	BL25A	2LAI	42	25	62	42	80	120	2.0	0.420	700	1100	10	27	20	100
02.0526	BL30A	2LAI	48	30	62	48	100	120	2.5	0.524	900	1500	9	35	25	120
02.0527	BL35A	2LAI	50	35	62	50	120	150	2.5	0.438	1200	2000	8	40	30	140
02.0528	BL40A	2LAI	55	40	62	55	120	150	2.7	0.491	1500	2200	7	45	35	160
02.0529	BL45A	2LAI	60	45	62	60	120	150	3.0	0.550	1800	2500	7	50	40	175
02.0531	BL60A	3LAI	80	60	86	80	300	350	4.0	1.440	3000	4000	6	70	55	320
02.0532	BL70A	3LAI	90	70	86	90	400	450	4.5	1.645	3700	4500	6	90	70	400

Do you require special dimensions? BL...A special sockets can be made to your requirements. Just send us the inquiry form (download: www.staubli.com/electrical -> Downloads -> Online Forms -> Checklist)

¹⁾ End temperature
²⁾ r.m.s. value



PLUGS

Plugs S...N with thread termination



Plugs S...N as power supply connection for a slide-in rack unit

S2N-S10N

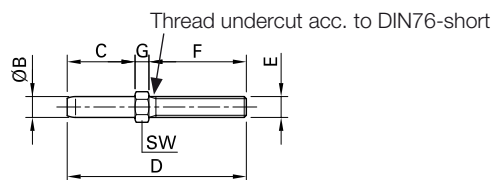

S12N-S50N

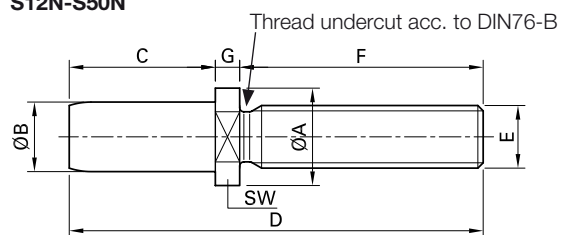

Crimping sleeves H...N/M... to change the thread termination to a crimp termination, see page 31.



Matching parts B...N pages 12-13

Matching parts BL...N pages 14-15

Matching parts BL...A pages 16-17

Connection aids pages 33-35

Termination examples

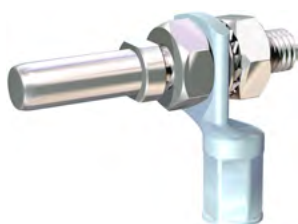

Cable lug

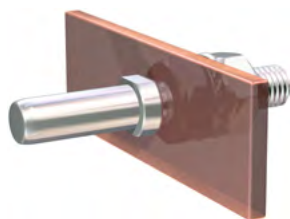

Busbar

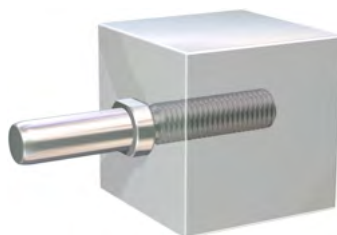

Contact block



Insulated panel or housing

Order No.	Type	Dimensions (mm)								Tightening torque	Weight	Rated current (60 °C) ¹⁾	Rated current (150 °C) ¹⁾
		Ø A	Ø B	C	D	E	F	G	SW				
04.0001	S2N	–	2	16.5	35.5	M3	16	3	4	0.5	0.002	35	50
04.0002	S3N	–	3	16.5	40	M4	20	3.5	5	1.2	0.003	40	55
04.0003	S4N	–	4	19.5	48.5	M5	25	4	6	2.0	0.006	65	90
04.0004	S5N	–	5	19.5	48.5	M5	25	4	7	2.0	0.008	70	100
04.0005	S6N	–	6	19.5	51.5	M6	28	4	8	3.0	0.012	100	180
04.0006	S8N	–	8	34	75	M8	36	5	11	6.0	0.030	130	240
04.0007	S10N	–	10	34	81	M10	42	5	13	10	0.050	200	350
04.0008	S12N	18	12	34	87	M12	48	5	13	16	0.077	230	420
04.0009	S14N	20	14	38	95	M14	50	7	17	22	0.118	300	500
04.0010	S16N	22	16	38	103	M16	58	7	19	30	0.166	350	540
04.0011	S18N	25	18	42	107	M16	58	7	22	30	0.199	400	640
04.0012	S20N	28	20	42	119	M18	70	7	24	40	0.265	500	760
04.0013	S25N	38	25	62	145	M20	74	9	32	52	0.496	700	1100
04.0014	S30N	42	30	62	152	M24x2	81	9	36	80	0.730	900	1500
04.0015	S35N	48	35	62	162	M30x2	90	10	41	150	1.126	1200	2000
04.0016	S40N	52	40	62	178	M36x3	105	11	46	250	1.623	1500	2200
04.0017	S45N	60	45	62	217	M42x3	140	15	50	350	2.635	1800	2500
04.0018	S50N	65	50	62	217	M48x3	140	15	55	450	3.345	2000	2800

¹⁾ End temperature

Plugs

Plugs SP...N with crimp termination

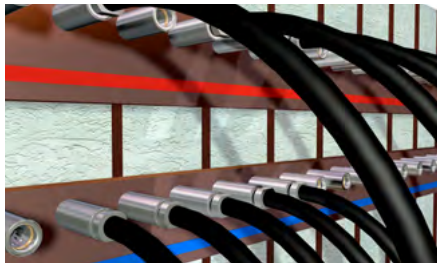

Plugs SP...N to contact busbars

SP3N/4 – SP4N/6

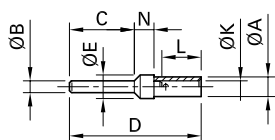

Crimp termination for flexible and highly flexible Cu-cables class 6 (according to IEC 60228). Stäubli recommends a hexagonal crimp. Indent crimping and soldering

SP4N/10 – SP8N/25

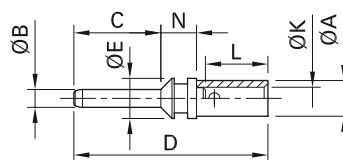

is also possible. Cables with compacted conductors need a special crimping sleeve. Crimping pliers see page 37.



Matching parts B...N pages 12-13
Matching parts BL...N pages 14-15
Reduction sleeves page 32

T6N

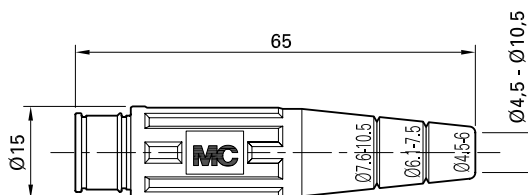

Order No.	Type	Dimensions (mm)								Weight	Cable cross section Cu	Rated current (80 °C) ²⁾
		Ø A	Ø B	C	D	Ø E	Ø K	L	N			
05.0003	SP3N/4	5	3	16.5	33.5	6	3	10	5	0.004	4	30
05.0004	SP3N/6	6	3	16.5	33.5	6	4	12	5	0.004	6	35
05.0005	SP4N/6	6	4	19.5	38	6	4	12	4.5	0.005	6	40
05.0006	SP4N/10 ¹⁾	8	4	19.5	43.5	9	5	14	8	0.009	10	50
05.0007	SP5N/10 ¹⁾	8	5	19.5	43	9	5	14	7.5	0.011	10	60
05.0009	SP6N/10 ¹⁾	8	6	19.5	42.5	9	5	14	7	0.012	10	80
05.0010	SP6N/16 ¹⁾	9	6	19.5	42.5	9	6	14	7	0.011	16	100
05.0012	SP8N/16 ¹⁾	9	8	34	56	9	6	14	6	0.020	16	100
05.0013	SP8N/25 ¹⁾	11	8	34	65	9	8	17	12	0.030	25	120

Other dimensions for sockets B...N, BL...N
and BL...A, on request

¹⁾ For these plugs coloured sleeves are available,
see page 23.

²⁾ End temperature

STÄUBLI LOCKING SYSTEM (AR-system)

The Stäubli Locking system (AR) operates on the “push-pull” principle. It is self-locking when connected. Disconnection is effected by an axially displaceable coupling ring: first push, then pull to disconnect.

Dirty parts should be cleaned with industrial alcohol before connecting.

Locking

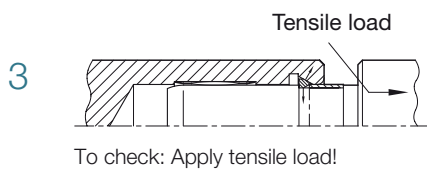
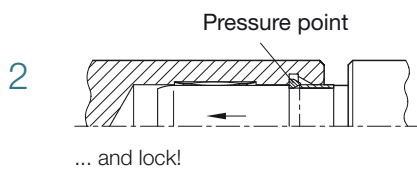
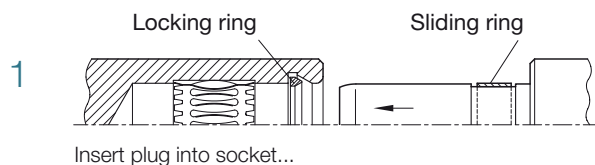

Releasing

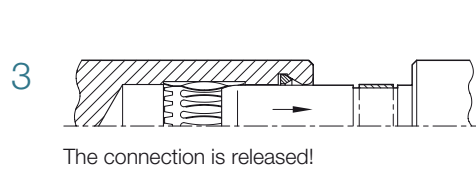
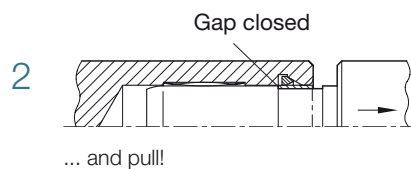
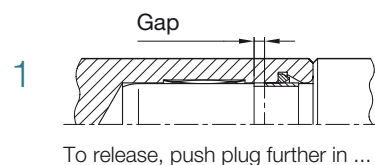



SOCKETS WITH SNAP-IN LOCK

Sockets B...AR-N with thread termination



B6AR-N-S

Thread run-out acc. to DIN76-short

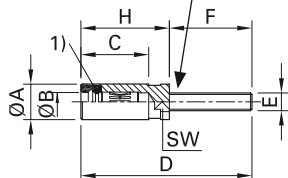

B10AR-N, B14AR-N

Thread undercut acc. to DIN76-B

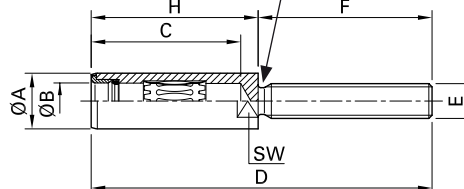

IH

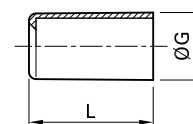

¹⁾ Plastic ring (POM)



Matching parts S...AR-N page 28

Matching parts SP...AR-N page 29

Matching parts SIG...AR-N page 30

Connection aids pages 33-35

Termination examples



Cable lug

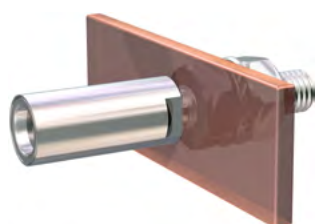

Busbar

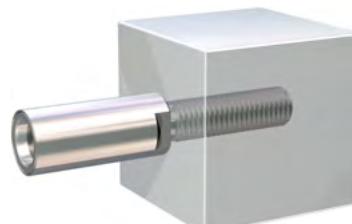

Contact block



Insulated panel or housing

Order No.	Type	MULTILAM	Dimensions (mm)									Withdrawal force	Insertion force	Tightening torque	Weight	Rated current (80 °C) ¹⁾	Contact resistance	Short-circuit current (1s) ²⁾	Short-circuit current (3s) ²⁾	Rated peak withstand current
			Ø A	Ø B	C	D	E	F	H	SW	N									
01.0200	B6AR-NS	LAIII	12	6	23	58	M6	28	30	10	25	30	3	0.026	100 (80) ³⁾	100	2.5	1.5	8	
01.0202	B10AR-N	LAI	16	10	43	98	M10	50	48	13	35	40	10	0.072	200 (180) ³⁾	50	5.5	4	20	
01.0203	B14AR-N	LAI	21	14	43	98	M14	50	48	17	50	55	22	0.127	300 (300) ³⁾	35	11.5	8	35	

Insulating sleeves IH... for sockets B...AR-N

Available on request (depending on quantity).

Order No.	Type	for sockets	Dimensions (mm)		Colours
			L	Ø G	
14.5006-*	IH6AR	B6AR-NS	26.5	14	21 22 23 24 25 28 29
14.5012-*	IH10AR-L	B10AR-N	36.5	18.5	21 22 23 24 25
14.5013-*	IH10AR-K	B10AR-N	21	18.5	21 22 23 24 25
14.5032-*	IH14AR	B14AR-N	32	23.5	21 22 23 24 25 29



Example:

B6AR-NS with insulating sleeve

IH6AR

* Add the desired colour code

¹⁾ End temperature

²⁾ r.m.s. value

³⁾ With insulating sleeve IH...

Sockets

Sockets BP...AR-N with snap-in lock and crimp termination

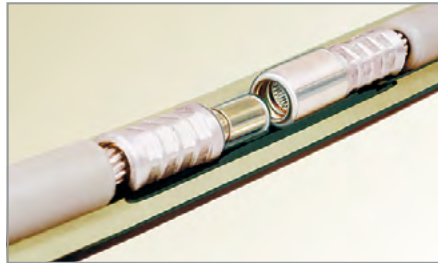

Socket BP and plug SP with a crimped compacted Al-conductor

BP6AR-N/10S – BP6AR-N/25-S

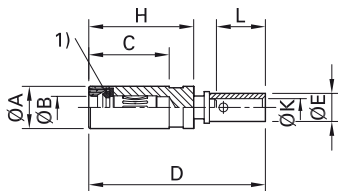

Crimp termination for flexible and highly flexible Cu-cables class 6 (according to IEC 6028). Stäubli recommends a hexagonal

BP10AR-N/25 – BP14AR-N/120

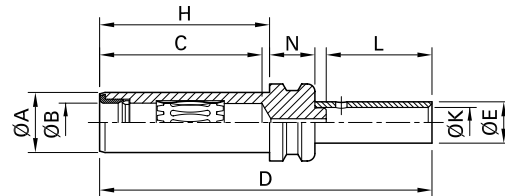

crimp. Indent crimping and soldering is also possible. Cables with compacted conductors need a special crimping sleeve.

Crimping pliers, see page 37. Insulating sleeves and cable insulators are also available for these sockets

¹⁾ Plastic ring (POM)



Matching parts S...AR-N page 28

Reduction sleeves page 32

Order No.	Type	MULTILAM	Dimensions (mm)										Withdrawal force	Insertion force	Weight	Cable cross section Cu	Rated current (80°C) ¹⁾	Contact resistance	Short-circuit current (1s) ²⁾	Short-circuit current (3s) ²⁾	Rated peak withstand current
			Ø A	Ø B	C	D	Ø E	Ø K	H	L	N	N									
01.0310	BP6AR-N/10-S	LAIII	12	6	23	48.5	8	5	28	14		25	30	0.026	10	80	100	1.2	0.7	8	
01.0311	BP6AR-N/16-S	LAIII	12	6	23	48.5	9	6	28	14		25	30	0.026	16	100	100	2	1	8	
01.0312	BP6AR-N/25-S	LAIII	12	6	23	54.5	11	8	28	16		25	30	0.026	25	130	100	2.5	1.5	8	
01.0303	BP10AR-N/25	LAI	16	10	43	76	11	8	45	15	12	35	40	0.083	25	130	50	3	1.5	20	
01.0304	BP10AR-N/35	LAI	16	10	43	81	13	9	45	20	12	35	40	0.084	35	150	50	4	2.5	20	
01.0305	BP10AR-N/50	LAI	16	10	43	88	14.5	11	45	27	12	35	40	0.089	50	180	50	5.5	3	20	
01.0306	BP14AR-N/50	LAI	21	14	43	93	14.5	11	45	27	17	50	55	0.145	50	190	35	5.5	3	40	
01.0307	BP14AR-N/70	LAI	21	14	43	93	17	13	45	27	17	50	55	0.149	70	240	35	8	5	40	
01.0308	BP14AR-N/95	LAI	21	14	43	95	20	15	45	29	17	50	55	0.163	95	280	35	11.5	6.5	40	
01.0309	BP14AR-N/120	LAI	21	14	43	96	22	17	45	30	17	50	55	0.168	120	300	35	12	8	40	

Matching insulating sleeves and sleeves, upon request

IH6



+

T6N



Type	for sockets	for cable outer--Ø
IH6 + T6N	BP6...	4,5 – 13 mm

¹⁾ End temperature

²⁾ r.m.s. value

Plugs S...AR-N with snap-in lock and thread termination

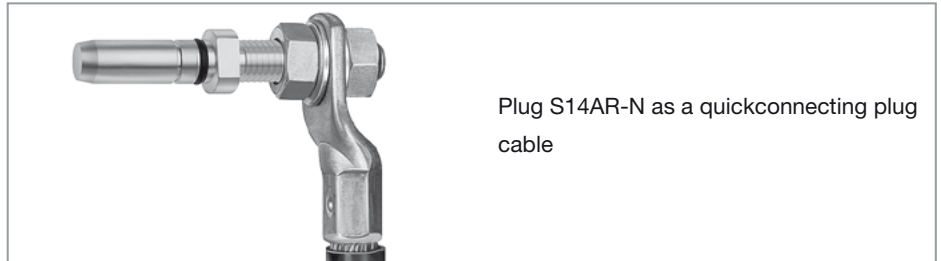

Plug S14AR-N as a quickconnecting plug cable

S6AR-N

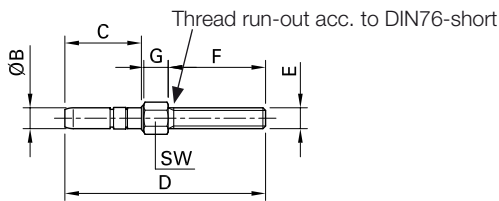

S10AR-N; S14AR-N

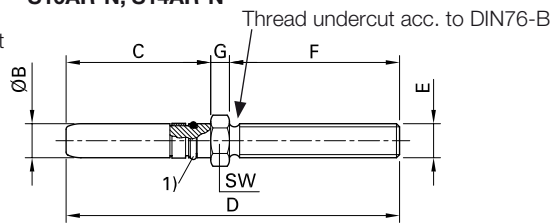

Termination examples



Cable lug

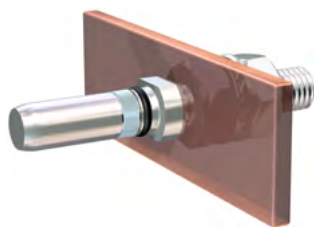

Busbar



Contact block



Insulated panel or housing

Order No.	Type	Dimensions (mm)							Tightening torque	Weight	Rated current (80 °C) ²⁾
		B	C	D	E	F	G	SW			
04.0201	S6AR-N	6	22	58	M6	28	7	8	3	0.014	100
04.0202	S10AR-N	10	42.5	98	M10	50	5.5	13	10	0.060	200
04.0203	S14AR-N	14	43	100	M14	50	7	17	22	0.123	300

¹⁾ O-ring made of NBR

²⁾ End temperature



Matching parts B...AR-N pages 24-25

Matching parts BP...AR-N pages 26-27

Connection aids pages 33-35

Plugs SP...AR-N with snap-in lock and crimp termination



SP6AR-N/...

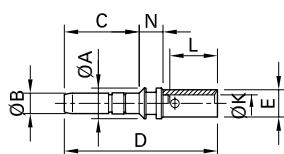

SP10AR-N/...; SP14AR-N/...

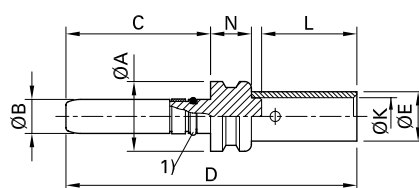

Crimp termination for flexible Cu-cables class 5 and highly flexible Cu-cables class 6 (according to IEC 60228). Stäubli recommends a hexagonal crimp. Indent crimping and soldering is also possible. Cables

with compacted conductors need a special crimping sleeve. Crimping pliers, see page 37. Insulating sleeves are also available for these plugs, (see catalogue “Round Connectors, 1-pole insulated, 6 mm“).

Order No.	Type	Dimensions (mm)								Weight kg	Cable cross section Cu mm ²	Rated current (80 °C) ²⁾ A
		Ø A	Ø B	C	D	Ø E	Ø K	L	N			
05.0201	SP6AR-N/10	9	6	22	45	8	5	14	7	0.012	10	80
05.0202	SP6AR-N/16	9	6	22	45	9	6	14	7	0.013	16	100
05.0210	SP6AR-N/25	9	6	22	51	11	8	20	7	0.016	25	130
05.0203	SP10AR-N/25	20.5	10	42.5	73.5	11	8	16	12	0.066	25	130
05.0204	SP10AR-N/35	20.5	10	42.5	78.5	13	9	21	12	0.073	35	150
05.0205	SP10AR-N/50	20.5	10	42.5	85.5	14.5	11	28	12	0.074	50	180
05.0206	SP14AR-N/50	25	14	43	91	14.5	11	27	17	0.133	50	190
05.0207	SP14AR-N/70	25	14	43	91	17	13	27	17	0.138	70	240
05.0208	SP14AR-N/95	25	14	43	93	20	15	29	17	0.150	95	280
05.0209	SP14AR-N/120	25	14	43	94	22	17	30	17	0.158	120	300

¹⁾ O-ring made of NBR

²⁾ End temperature



Matching parts B...AR-N pages 24-25

Matching parts BP...AR-N pages 26-27

Reduction sleeves page 32

Plugs SIG...AR-N with snap-in lock and internal thread termination

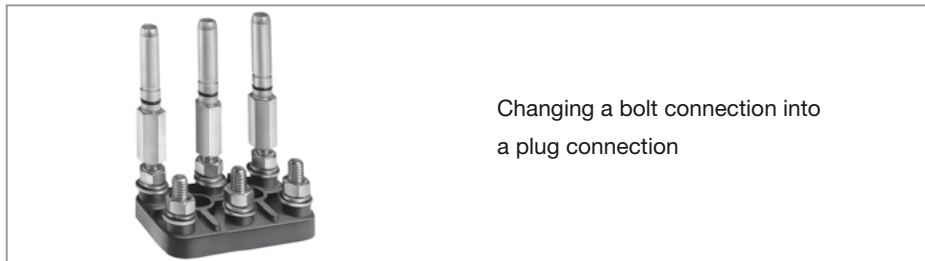
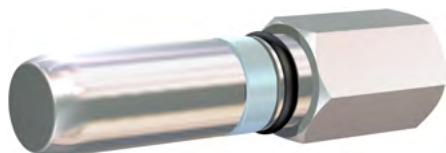

SIG6AR-N/...

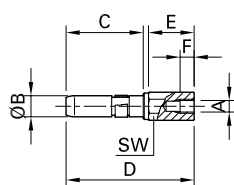

SIG10AR-N/...; SIG14AR-N/...

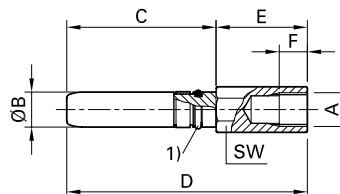

Order No.	Type	Dimensions (mm)							Tightening torque	Weight	Rated current (80 °C) ²⁾
		A	Ø B	C	D	E	F	SW			
06.0001	SIG6AR-N/3	M3	6	22	36.5	13	4	8	0.5	0.011	16
06.0002	SIG6AR-N/4	M4	6	22	36.5	13	4	8	1.2	0.012	25
06.0003	SIG6AR-N/5	M5	6	22	36.5	13	5	8	2	0.011	40
06.0004	SIG6AR-N/6	M6	6	22	36.5	13	5	8	3	0.011	75
06.0006	SIG10AR-N/8	M8	10	42.5	68.5	26	6	13	6	0.056	130
06.0007	SIG10AR-N/10	M10	10	42.5	68.5	26	8	13	10	0.054	180
06.0009	SIG14AR-N/10	M10	14	43	69	26	8	17	10	0.102	180
06.0010	SIG14AR-N/12	M12	14	43	69	26	10	17	16	0.099	230
06.0011	SIG14AR-N/14	M14	14	43	69	26	10	17	22	0.094	300

¹⁾ O-ring made of NBR

²⁾ End temperature



Matching parts B...AR-N pages 24-25

Matching parts BP...AR-N pages 26-27

ACCESSORIES

Crimping Sleeves H...N/M... with thread

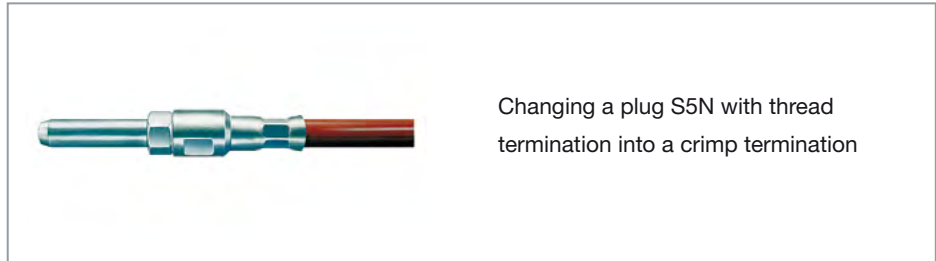

Changing a plug S5N with thread termination into a crimp termination

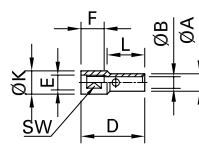
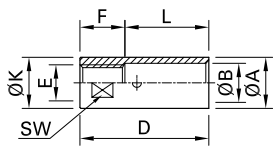

Stäubli crimping sleeves H...N/M... are suitable for changing all sockets B...N and B...AR-N and plugs S...N and S...AR-N from thread termination to a crimp termination. The thread termination have to be shortened

accordingly to the size max. F and then the crimping sleeves can be screwed on and secured. The crimping sleeves are suitable for flexible and highly flexible Cu-cables (according to IEC 60228). Stäubli recommends

a hexagonal crimp. Indent crimping is possible. Cables with compacted conductors need a special crimping sleeve. Crimping pliers, see page 37.

Order No.	Type	Dimensions (mm)								Tightening torque	Weight	Cable cross section Cu
		A	B	D	E	F	K	L	SW			
07.0002	H2,5N/M3	4.2	2.3	19	M3	9	5.5	8	4.5	0.5	0.002	2.5
07.0003	H4N/M4	5	3	20	M4	8	7	10	6	1.2	0.004	4
07.0005	H6N/M5	6	4	22	M5	8	8	12	7	2	0.004	6
07.0008	H16N/M5	9	6	21	M5	7.5	9	14	8	2	0.005	16
07.0009	H16N/M6	9	6	24	M6	8.5	10	14	8	3	0.007	16
07.0012	H25N/M8	11	8	27	M8	10	12	19	10	6	0.015	25
07.0013	H25N/M10	11	8	35	M10	16	14	17	12	10	0.020	25
07.0017	H50N/M10	14.5	11	41	M10	13	14.5	28	12	10	0.028	50
07.0018	H50N/M12	14.5	11	44	M12	13	16	28	14	16	0.028	50
07.0020	H70N/M12	17	13	43	M12	15	17	28	14	16	0.040	70
07.0022	H95N/M14	20	15	48	M14	18	20	30	17	22	0.064	95
07.0025	H120N/M16	22	17	50	M16	20	22	30	19	30	0.065	120
07.0026	H150N/M16	25	19	54	M16	21	25	33	22	30	0.115	150
07.0029	H185N/M18	27	21	62	M18	25	27	37	24	40	0.135	185
07.0032	H240N/M20	30	24	69	M20	27	30	42	26	52	0.196	240

Further dimensions for sockets B...N and plugs S...N, on request

Reducing sleeves RH...

Allows smaller cable cross sections to be crimped in the crimping sleeves. Material:

Cu, silver plated, crimpable. Crimping pliers, see page 37.

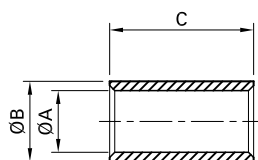

Order No.	Type	Reduction (from/to)	Dimensions (mm)		
			mm ²	Ø A	Ø B
05.5114	RH6-2,5 AG	6/2.5	2.3	3.8	10
05.5113	RH10-2,5 AG	10/2.5	2.3	4.8	11
05.5103	RH10-4 AG	10/4	3	4.8	12
05.5102	RH10-6 AG	10/6	4	4.8	11
05.5111	RH16-6 AG	16/6	4	5.8	12
05.5112	RH16-10 AG	16/10	5	5.8	12
05.5108	RH25-16 AG	25/16	6	7.8	14
05.5104	RH50-16 AG	50/16	6	10.8	26
05.5105	RH50-25 AG	50/25	8	10.8	26
05.5106	RH50-35 AG	50/35	9	10.8	26
05.5115	RH70-50 AG	70/50	11	12.8	26
05.5110	RH95-70 AG	95/70	13	14.8	28
05.5107	RH120-95 AG	120/95	15	16.8	29
05.5109	RH150-120 AG	150/120	17	18.8	32

Nuts, Washers, Serrated lock washers

Nuts MU, washers U and serrated lock washers F fit for the thread terminations of sockets B...N and B...AR-N and plugs

S...N and S...AR-N. Nuts MUE and washers UE are suitable for screwing the mounting sockets BL...N into bus-bars. All the MU and

U type nuts and washers are made of brass and silver plated. Serrated lock washers are made of steel, zinc plated.

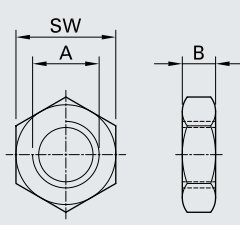
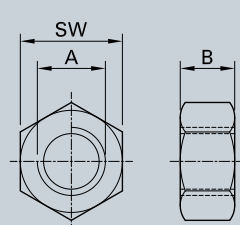
Order No.	Type	Dimension (mm)			DIN	Illustration
		A	B	SW		
08.0001	MU0,5D/M3	M3	1.8	5.5	439	
08.0002	MU0,5D/M4	M4	2.2	7	439	
08.0003	MU0,5D/M5	M5	2.7	8	439	
08.0004	MU0,5D/M6	M6	3.2	10	439	
08.0005	MU0,5D/M8	M8	4	13	439	
08.0006	MU0,5D/M10	M10	5	17	439	
08.0007	MU0,5D/M12	M12	6	19	439	
08.0008	MU0,5D/M14	M14	7	22	439	
08.0009	MU0,5D/M16	M16	8	24	439	
08.0010	MU0,5D/M18	M18	9	27	439	
08.0011	MU0,5D/M20	M20	10	30	439	
08.0012	MU0,5D/M24x2	M24x2	12	36	439	
08.0013	MU0,5D/M30x2	M30x2	15	46	439	
08.0014	MU0,5D/M36x3	M36x3	18	54	439	
08.0101	MU0,8D/M3	M3	2.4	5.5	934	
08.0102	MU0,8D/M4	M4	3.2	7	934	
08.0103	MU0,8D/M5	M5	4	8	934	
08.0104	MU0,8D/M6	M6	5	10	934	
08.0105	MU0,8D/M8	M8	6.5	13	934	
08.0106	MU0,8D/M10	M10	8	17	934	
08.0107	MU0,8D/M12	M12	10	19	934	
08.0108	MU0,8D/M14	M14	11	22	934	
08.0109	MU0,8D/M16	M16	13	24	934	
08.0110	MU0,8D/M18	M18	15	27	934	
08.0111	MU0,8D/M20	M20	16	30	934	
08.0112	MU0,8D/M24x2	M24x2	19	36	934	
08.0113	MU0,8D/M30x2	M30x2	24	46	934	
08.0114	MU0,8D/M36x3	M36x3	29	55	934	

Order No.	Type	Dimension (mm)			DIN	Illustration
		A	B	C		
08.0301	U/M3	7	3.2	0.5	125	
08.0302	U/M4	9	4.3	0.8	125	
08.0303	U/M5	10	5.3	1	125	
08.0304	U/M6	12	6.4	1.6	125	
08.0305	U/M8	16	8.4	1.6	125	
08.0306	U/M10	20	10.5	2	125	
08.0307	U/M12	24	13	2.5	125	
08.0308	U/M14	28	15	2.5	125	
08.0309	U/M16	30	17	3	125	
08.0310	U/M18	34	19	3	125	
08.0311	U/M20	37	21	3	125	
08.0312	U/M24x2	44	25	4	125	
08.0313	U/M30x2	56	31	4	125	
08.0314	U/M36x3	66	37	5	125	
08.0701	F/M3	6	3.2	1.2	6798	
08.0702	F/M4	8	4.3	1.5	6798	
08.0703	F/M5	9	5.1	1.5	6798	
08.0704	F/M6	11	6.4	2.1	6798	
08.0705	F/M8	14	8.2	2.4	6798	
08.0706	F/M10	18	10.5	2.7	6798	
08.0707	F/M12	20.5	12.5	3	6798	
08.0708	F/M14	24	14.5	3	6798	
08.0709	F/M16	26	16.5	3.6	6798	
08.0710	F/M18	30	19	4.2	6798	
08.0711	F/M20	33	21	4.2	6798	

Order No.	Type	Dimension (mm)					fits to	Illustration
		A	B	C	D	SW		
08.0201	MUE/M8x0,75	M8x0.75	3				11	BL2N, BL3N, BL4N
08.0202	MUE/M10x1	M10x1	3				13	BL5N
08.0203	MUE/M12x1	M12x1	3				17	BL6N
08.0204	MUE/M14x1	M14x1	4				19	BL6AR-N, BL8N
08.0205	MUE/M18x1	M18x1	4				24	BL10N
08.0206	MUE/M20x1	M20x1	4				27	BL12N
08.0207	MUE/M22x1	M22x1	6				30	BL14N
08.0208	MUE/M24x1	M24x1	6				32	BL16N
08.0209	MUE/M28x1	M28x1	6				36	BL18N
08.0210	MUE/M30x1	M30x1	8				41	BL20N
08.0211	MUE/M42x1,5	M42x1.5	8				55	BL25N
08.0212	MUER/M48x1,5	M48x1.5	10	65	6			BL30N
08.0213	MUER/M50x1,5	M50x1.5	10	70	6			BL35N
08.0214	MUER/M55x1,5	M55x1.5	12	75	6			BL40N
08.0215	MUER/M60x2	M60x2	12	80	6			BL45N
08.0216	MUER/M65x2	M65x2	12	85	8			BL50N
08.0217	MUER/M80x2	M80x2	12	105	8			BL60N
08.0218	MUER/M90x2	M90x2	15	115	8			BL70N
08.0219	MUER/M100x2	M100x2	15	125	10			BL80N
08.0220	MUER/M110x2 ¹⁾	M110x2	15	135	10			BL90N
08.0221	MUER/M120x2 ¹⁾	M120x2	15	145	10			BL100N
08.0401	UE/M8x0,75		16	8.5	1			
08.0402	UE/M10x1		18	10.5	1			
08.0403	UE/M12x1		22	12.5	1			
08.0404	UE/M14x1		25	14.5	1.5			
08.0405	UE/M18x1		30	19	2			
08.0406	UE/M20x1		34	21	2			
08.0407	UE/M22x1		38	23	2			
08.0408	UE/M24x1		40	25	2			
08.0409	UE/M28x1		45	29	3			
08.0410	UE/M30x1		52	31	3			
08.0411	UE/M42x1,5		68	43	3			

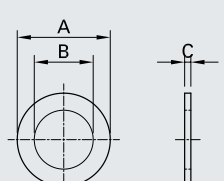
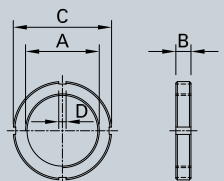
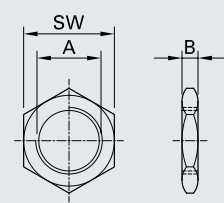

¹⁾ Only on request, not in stock

WHAT IS AXICLAMP?

The patented lead connecting system

The patented lead connecting system for electrical and mechanical connection of Cu leads 6 mm² – 300 mm² class 5 and class 6 according to DIN VDE 0295, IEC 60228.

The individual strands of the connecting lead are screw-clamped against a metal cone by means of a tapered threaded sleeve. The metal cone is part of the contact body.

with an equally good transition resistances compared to a crimp connection and additional advantages besides.

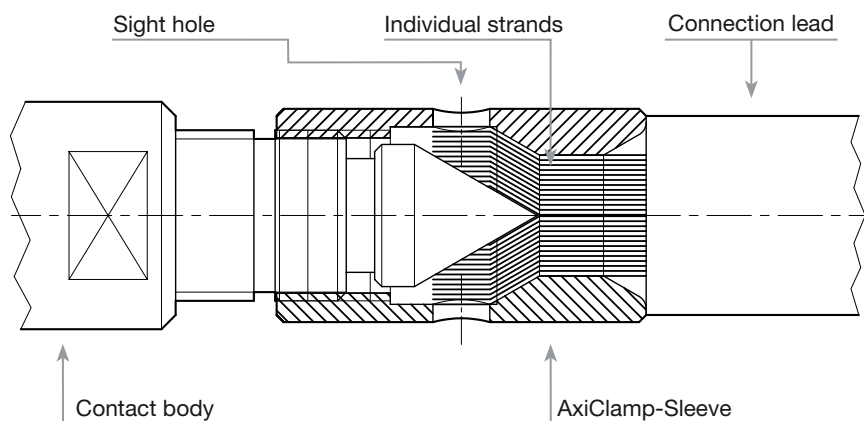

Electrical and thermal tests:

DIN EN 61238-1, Compression and mechanical connectors for power cable for rated voltages up to 30 kV (Um = 36 kV).

Mechanical tests:

DIN EN 60068-2-6, environmental tests, test Fc: vibration, sinusoidal.

Test parameter:







g-load:	10 g
Amplitude:	0.75 mm
Frequency:	10 up to 500 Hz
Time:	3 x 112 min.

Advantages over conventional crimp terminations:

1. No crimping pliers or crimping inserts etc. required.
2. Lead can be disconnected, i.e. AxiClamp can be re-used in event of lead being replaced.
3. One AxiClamp size can be used for different cable cross sections.
4. Time- and cost saving.

APPENDIX

Stäubli recommended Crimping pliers and crimping inserts

	Order No.	Type	For conductor cross section	Crimp form	Tractive system		Operating instructions ²⁾
					Hand	Hand-Hydraulic	
	32.6001	DMC PV-CZL	2.5 mm ² – 6 mm ²	Eight indent crimp	×		
	18.3700	BEKU Apparatebau M-PZ13	6 mm ² – 25 mm ²	Hexagonal	×		 MA224
	18.3710	Elpress M-PZ-T2600	10 mm ² – 95 mm ²	Hexagonal	×		 MA226
	1)	Elpress V1311C	10 mm ² – 300 mm ²	Hexagonal	×	×	 MA069

Inserts

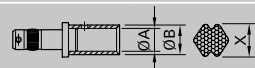
				Sizes of crimp sleeves for conductor class 6 ³⁾			
Conductor cross section		Crimping pliers	Order No.	Insert			X = Control dimension
mm ²	AWG				Ø A mm	Ø B mm	
6	8	2	18.3701	MES-PZ-TB5/6	4	6	–
10	6	2	18.3702	MES-PZ-TB8/10	5	8	6.3
16	4	2	18.3703	MES-PZ-TB9/16	6	9	7.3
25	2	2	18.3704	MES-PZ-TB11/25	8	11	8.8
35	1	3	18.3712	TB9-13 (KRF)	9	13	10.2
50	1/0	3	18.3713	TB11-14,5 (KRF)	11	14.5	11.4
70	3/0	3	18.3711	TB8-17 (KRF)	13	17	13.4
95	4/0	3	18.3714	TB20 (KRF)	15	20	16.4
120	–	4	1)	B22 (KRF)	17	22	16.3
150	–	4	1)	B25 (KRF)	19	25	20.3
185	–	4	1)	13CB27 (KRF)	21	27	20.5
240	–	4	1)	13CB30 (KRF)	24	30	23.3



Assembly instructions

MA224, MA226, MA069

www.staubli.com/electrical

¹⁾ Not delivered by Stäubli. Download of ordering informations: www.staubli.com/electrical > Products > Industrial Connectors > Technical Info > Crimping pliers

²⁾ see www.staubli.com/electrical

³⁾ According to IEC 60228, DIN VDE 0295, sizes of crimp sleeves for conductor class 5, on Request.

Derating Diagrams

For PVC-insulated Cu-wires (70 °C) 2.5 mm²-240 mm² acc. to DIN VDE 0298 part 4.

Utilisation of cables and cords in power installations.

Part 4: Recommended current-carrying capacity for sheathed and nonsheathed cables for free in air in buildings and for flexible cables and cords.

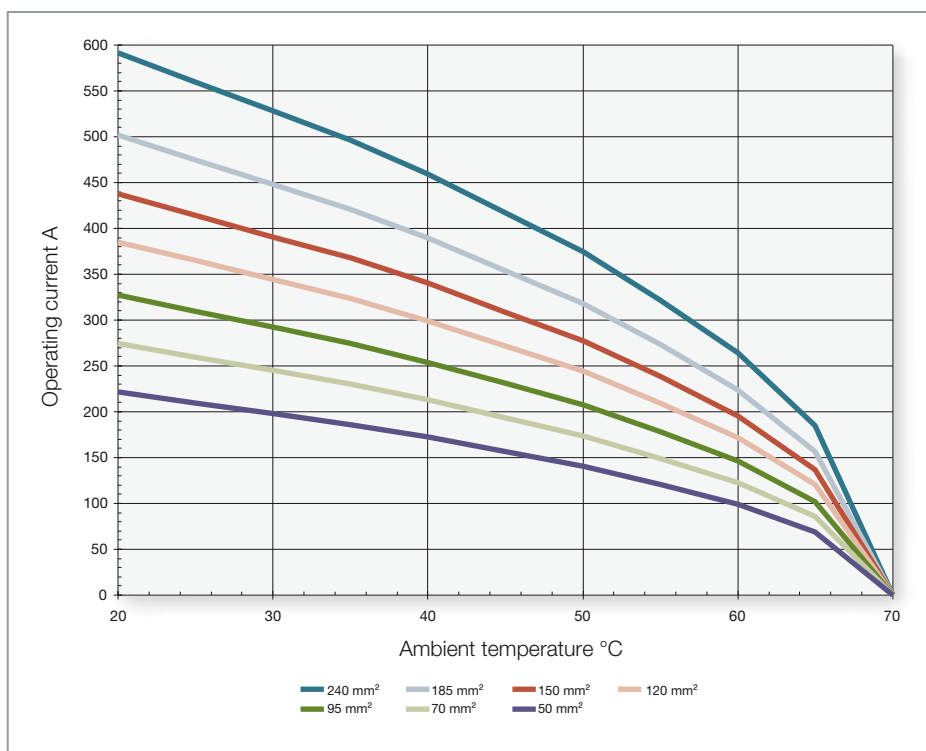
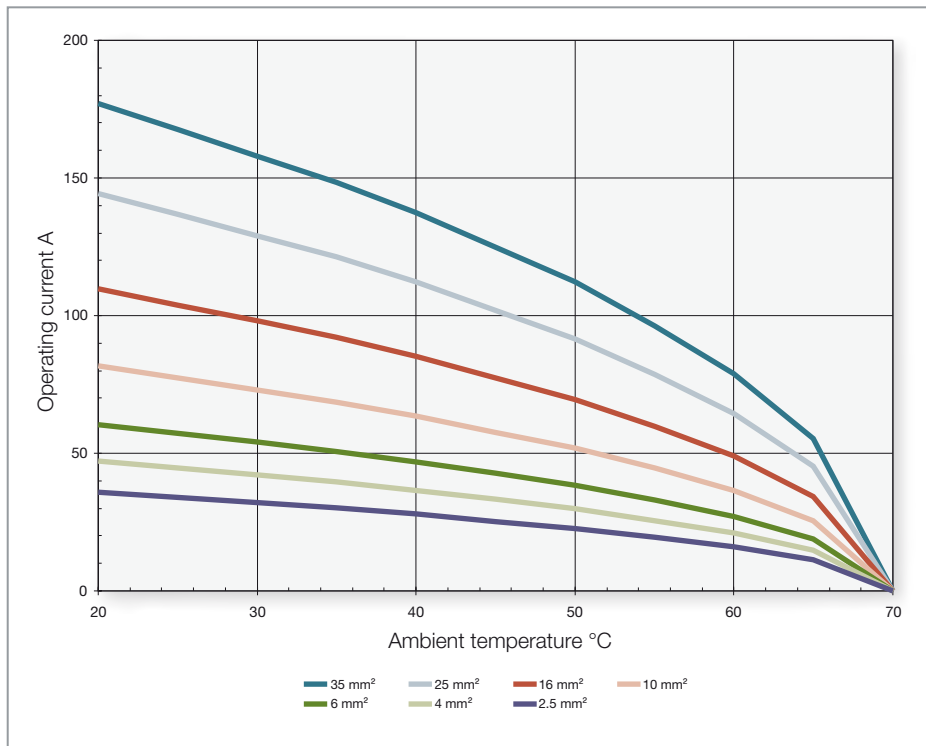

For 10 mm rectangular section Cu-Busbars acc. to DIN 43671

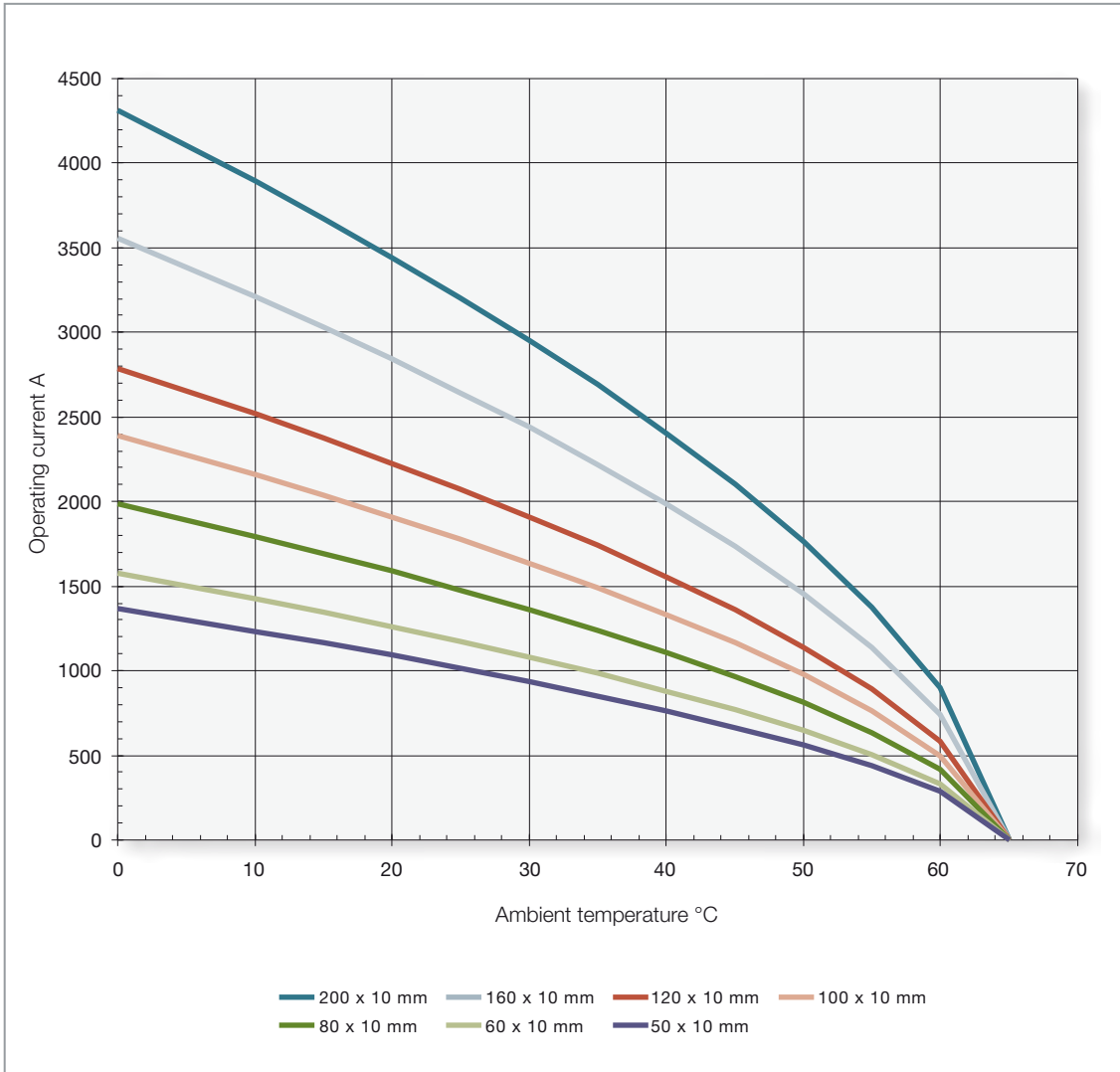

Technical information

MULTILAM type

For a technical description of electrical contacts with MULTILAMs, see publication: "The MULTILAM principle".

Withdrawal and mating forces

The stated figures refer to forces after 20-30 mating cycles with a thin film of lubricant present. Forces are greater in the new condition.

TIGHTENING TORQUES

The torque figures apply for clean, lightly lubricated bolts, nuts and washers.

Rated current (IEC 61984)

Current value determined by Stäubli which the connector can carry continuously (without interruption) and simultaneously through all its contacts wired with the largest specified conductor, at an ambient temperature of 20 °C, without the upper limiting temperature being exceeded.

Contact resistance

is the resistance occurring at the contact point of two contact surfaces. Ist value is calculated from the measured voltage drop at the rated current.

Symbol	Material description	Temperature °C
POM	Polyoxymethylene	-40...+100
NBR	Acrylonitrile-Butadine-Elastomer	-30...+100
PA	Polyamide	-30...+90

Lubricant

Stäubli recommends the following lubricants:

- **Grease (general elec. contacts):**
Klüberemp® GR UT 18 (73.1059)*
Kontasynth BA100 Spray (73.1051)*
- **Sliding grease in SF6-gas:**
Barrierta I EL-102*
- **Assembly and sealing grease:**
Barrierta I S-402 or Barrierta I MI -202*

Mating cycles

The maximum number of mating cycles of the standard plug-in connections is between 1000 and 5000, depending on duty conditions. Precondition is a thin film of lubricant on the contacts prior to initial mating. Because higher cycle numbers call for special surface treatment, guiding and lubrication measures, each case must be individually investigated to establish the required measures. Please enquire, we'll be glad to advice you.

Crimp terminations

For conductor terminations, we recommend hexagonal crimping for our crimp sleeves. Afterwards the sleeve can be notched with a drift. Our crimp sleeves are designed for flexible or highly flexible Cu-conductors. Cables with compact conductors need a special crimping sleeve.

Crimping pliers, see page 37.

By the way: Stäubli also manufactures lead and cable assemblies complete with connectors!

* from Klüber Lubrication, Munich

Safety notes

Fundamental rule of protection against electric shock

[IEC 61140 Pt. 4]

Hazardous-live-parts shall not be accessible and accessible conductive parts shall not be dangerous to touch:

- either under normal conditions (operation in intended use and in the absence of a fault,
- or under single-fault conditions, e. g. failure of basic insulation.

UL 1977 “Component connectors for use in data, signal control and power applications”

There shall be an air- or creepage distance over surface of 3.2 mm (1/8 inch) or more for a an uninsulated live part of opposite polarity.

- a) an uninsulated live part of opposite polarity.
- b) an uninsulated grounded metal part.
- c) a non-current carrying metal part that is exposed to contact by persons when the device is installed and used in the intended manner.

IEC 61984 “Connectors – Safety requirements and tests”

This international standard applies to connectors with rated voltages above 50 V and up to 1000 V and rated currents up to 125 A per contact, for which either no detailed specification (DS) exists for which the DS refers to this standard with regard to safety.

Extracts from IEC 61984: June 2001 and remarks

1) Connectors

Connectors should not be under voltage or under load/current when connection is made. An electrical or mechanical interlock prevent the contacts of a connector from becoming live before it is in proper engagement, or from being withdrawn while its contacts are live. An interlock can be obtained by micro switch.

Protection against electric shock for unenclosed connectors.

Protection against electric shock is provided by the customer by the enclosure of the equipment in which the connector is mounted. Or a safety extra low voltage (SELV) is applied.

Protection against electric shock for enclosed connectors

- Mated condition: clearance and creepage distances are measured between live parts and the IEC probe with a test force of 20 N.
- Unmated condition, contact openings (lead-ins) in the mating face: clearance and creepage distances are not taken into account.

For a plug connector, clearance and creepage distances shall be measured through openings between the live parts and the plane of the mating face.

2) Plug device

During connection or disconnection, contacts are under voltage only; however, the contacts are not under load, they carry no current. Plug devices must have the stated breaking capacity or must be so designed that they can only be inserted and withdrawn without load (current). This can be achieved by an interlock device such as a micro switch.

- Mated condition: clearance and creepage distances must be measured between live parts and the IEC test probe.
- Unmated condition: contact openings (lead-in) clearance and creepage distances are measured between live parts and the mating face plane of the plug device. This does not apply to the male part of the connector.

3) Connector with breaking capacity (CBC)

Contacts are under voltage and current (load) during connection and disconnection. Stäubli plug devices are not suitable for connection or disconnection under load. No breaking capacity can be specified.

Alphabetic index

Order No.	Type	Page
–	13CB27 (KRF)	37
–	B22 (KRF)	37
–	B25 (KRF)	37
–	V1311C	37
01.0001	B2N	13
01.0002	B3N	13
01.0003	B4N	13
01.0004	B5N	13
01.0005	B6N	13
01.0006	B8N	13
01.0007	B10N	13
01.0008	B12N	13
01.0009	B14N	13
01.0010	B16N	13
01.0011	B18N	13
01.0012	B20N	13
01.0013	B25N	13
01.0014	B30N	13
01.0015	B35N	13
01.0016	B40N	13
01.0020	B8AX/25-35	9
01.0021	B12AX/50-70	9
01.0022	B16AX/95-120	9
01.0023	B20AX/150-185	9
01.0200	B6AR-NS	25
01.0202	B10AR-N	25
01.0203	B14AR-N	25
01.0303	BP10AR-N/25	27
01.0304	BP10AR-N/35	27
01.0305	BP10AR-N/50	27
01.0306	BP14AR-N/50	27
01.0307	BP14AR-N/70	27
01.0308	BP14AR-N/95	27
01.0309	BP14AR-N/120	27
01.0310	BP6AR-N/10-S	27
01.0311	BP6AR-N/16-S	27
01.0312	BP6AR-N/25-S	27
02.0001	BL2N	15
02.0002	BL3N	15
02.0003	BL4N	15
02.0004	BL5N	15
02.0005	BL6N	15
02.0006	BL8N	15
02.0007	BL10N	15

Order No.	Type	Page
02.0008	BL12N	15
02.0009	BL14N	15
02.0010	BL16N	15
02.0011	BL18N	15
02.0012	BL20N	15
02.0013	BL25N	15
02.0014	BL30N	15
02.0015	BL35N	15
02.0016	BL40N	15
02.0017	BL45N	15
02.0018	BL50N	15
02.0019	BL60N	15
02.0020	BL70N	15
02.0021	BL80N	15
02.0022	BL90N	15
02.0023	BL100N	15
02.0201	BL6AR-N	15
02.0525	BL25A	17
02.0526	BL30A	17
02.0527	BL35A	17
02.0528	BL40A	17
02.0529	BL45A	17
02.0531	BL60A	17
02.0532	BL70A	17
04.0001	S2N	19
04.0002	S3N	19
04.0003	S4N	19
04.0004	S5N	19
04.0005	S6N	19
04.0006	S8N	19
04.0007	S10N	19
04.0008	S12N	19
04.0009	S14N	19
04.0010	S16N	19
04.0011	S18N	19
04.0012	S20N	19
04.0013	S25N	19
04.0014	S30N	19
04.0015	S35N	19
04.0016	S40N	19
04.0017	S45N	19
04.0018	S50N	19
04.0020	S8AX/25-35	9
04.0021	S12AX/50-70	9

Order No.	Type	Page
04.0022	S16AX/95-120	9
04.0023	S20AX/150-185	9
04.0201	S6AR-N	28
04.0202	S10AR-N	28
04.0203	S14AR-N	28
05.0003	SP3N/4	20
05.0004	SP3N/6	20
05.0005	SP4N/6	20
05.0006	SP4N/10	20
05.0007	SP5N/10	20
05.0009	SP6N/10	20
05.0010	SP6N/16	20
05.0012	SP8N/16	20
05.0013	SP8N/25	20
05.0201	SP6AR-N/10	29
05.0202	SP6AR-N/16	29
05.0203	SP10AR-N/25	29
05.0204	SP10AR-N/35	29
05.0205	SP10AR-N/50	29
05.0206	SP14AR-N/50	29
05.0207	SP14AR-N/70	29
05.0208	SP14AR-N/95	29
05.0209	SP14AR-N/120	29
05.0210	SP6AR-N/25	29
05.5102	RH10-6 AG	32
05.5103	RH10-4 AG	32
05.5104	RH50-16 AG	32
05.5105	RH50-25 AG	32
05.5106	RH50-35 AG	32
05.5107	RH120-95 AG	32
05.5108	RH25-16 AG	32
05.5109	RH150-120 AG	32
05.5110	RH95-70 AG	32
05.5111	RH16-6 AG	32
05.5112	RH16-10 AG	32
05.5113	RH10-2,5 AG	32
05.5114	RH6-2,5 AG	32
05.5115	RH70-50 AG	32
06.0001	SIG6AR-N/3	30
06.0002	SIG6AR-N/4	30
06.0003	SIG6AR-N/5	30
06.0004	SIG6AR-N/6	30
06.0006	SIG10AR-N/8	30
06.0007	SIG10AR-N/10	30

Order No.	Type	Page
06.0009	SIG14AR-N/10	30
06.0010	SIG14AR-N/12	30
06.0011	SIG14AR-N/14	30
07.0002	H2,5N/M3	31
07.0003	H4N/M4	31
07.0005	H6N/M5	31
07.0008	H16N/M5	31
07.0009	H16N/M6	31
07.0012	H25N/M8	31
07.0013	H25N/M10	31
07.0017	H50N/M10	31
07.0018	H50N/M12	31
07.0020	H70N/M12	31
07.0022	H95N/M14	31
07.0025	H120N/M16	31
07.0026	H150N/M16	31
07.0029	H185N/M18	31
07.0032	H240N/M20	31
07.1001	AX-BI/25-35	11
07.1002	AX-BI/50-70	11
07.1003	AX-BI/95-120	11
07.1004	AX-BI/150-185	11
08.0001	MU0,5D/M3	33
08.0002	MU0,5D/M4	33
08.0003	MU0,5D/M5	33
08.0004	MU0,5D/M6	33
08.0005	MU0,5D/M8	33
08.0006	MU0,5D/M10	33
08.0007	MU0,5D/M12	33
08.0008	MU0,5D/M14	33
08.0009	MU0,5D/M16	33
08.0010	MU0,5D/M18	33
08.0011	MU0,5D/M20	33
08.0012	MU0,5D/M24x2	33
08.0013	MU0,5D/M30x2	33
08.0014	MU0,5D/M36x3	33
08.0101	MU0,8D/M3	33
08.0102	MU0,8D/M4	33
08.0103	MU0,8D/M5	33
08.0104	MU0,8D/M6	33
08.0105	MU0,8D/M8	33
08.0106	MU0,8D/M10	33
08.0107	MU0,8D/M12	33
08.0108	MU0,8D/M14	33

Order No.	Type	Page
08.0109	MU0,8D/M16	33
08.0110	MU0,8D/M18	33
08.0111	MU0,8D/M20	33
08.0112	MU0,8D/M24x2	33
08.0113	MU0,8D/M30x2	33
08.0114	MU0,8D/M36x3	33
08.0201	MUE/M8x0,75	35
08.0202	MUE/M10x1	35
08.0203	MUE/M12x1	35
08.0204	MUE/M14x1	35
08.0205	MUE/M18x1	35
08.0206	MUE/M20x1	35
08.0207	MUE/M22x1	35
08.0208	MUE/M24x1	35
08.0209	MUE/M28x1	35
08.0210	MUE/M30x1	35
08.0211	MUE/M42x1,5	35
08.0212	MUER/M48x1,5	35
08.0213	MUER/M50x1,5	35
08.0214	MUER/M55x1,5	35
08.0215	MUER/M60x2	35
08.0216	MUER/M65x2	35
08.0217	MUER/M80x2	35
08.0218	MUER/M90x2	35
08.0219	MUER/M100x2	35
08.0220	MUER/M110x2	35
08.0221	MUER/M120x2	35
08.0301	U/M3	34
08.0302	U/M4	34
08.0303	U/M5	34
08.0304	U/M6	34
08.0305	U/M8	34
08.0306	U/M10	34
08.0307	U/M12	34
08.0308	U/M14	34
08.0309	U/M16	34
08.0310	U/M18	34
08.0311	U/M20	34
08.0312	U/M24x2	34
08.0313	U/M30x2	34
08.0314	U/M36x3	34
08.0401	UE/M8x0,75	35
08.0402	UE/M10x1	35
08.0403	UE/M12x1	35

Order No.	Type	Page
08.0404	UE/M14x1	35
08.0405	UE/M18x1	35
08.0406	UE/M20x1	35
08.0407	UE/M22x1	35
08.0408	UE/M24x1	35
08.0409	UE/M28x1	35
08.0410	UE/M30x1	35
08.0411	UE/M42x1,5	35
08.0701	F/M3	34
08.0702	F/M4	34
08.0703	F/M5	34
08.0704	F/M6	34
08.0705	F/M8	34
08.0706	F/M10	34
08.0707	F/M12	34
08.0708	F/M14	34
08.0709	F/M16	34
08.0710	F/M18	34
08.0711	F/M20	34
14.5006	IH6AR	25
14.5012	IH10AR-L	25
14.5013	IH10AR-K	25
14.5032	IH14AR	25
18.3700	M-PZ13	37
18.3701	MES-PZ-TB5/6	37
18.3702	MES-PZ-TB8/10	37
18.3703	MES-PZ-TB9/16	37
18.3704	MES-PZ-TB11/25	37
18.3710	M-PZ-T2600	37
18.3711	TB8-17 (KRF)	37
18.3712	TB9-13 (KRF)	37
18.3713	TB11-14,5 (KRF)	37
18.3714	TB20 (KRF)	37
32.6001	PV-CZL	37



● Stäubli Units ○ Representatives/Agents

Global presence of the Stäubli Group

www.staubli.com