

### Expanding the DIN Concept

- Mates with DIN connectors.
- Ideal for automated soldering because the Connectors sit on top of the board.
- Mounting dimensions of the DIN Style-1 Connectors are the same as the DIN connector.
- DIN Style-2 Connectors have widened dimensions for ease of mounting.

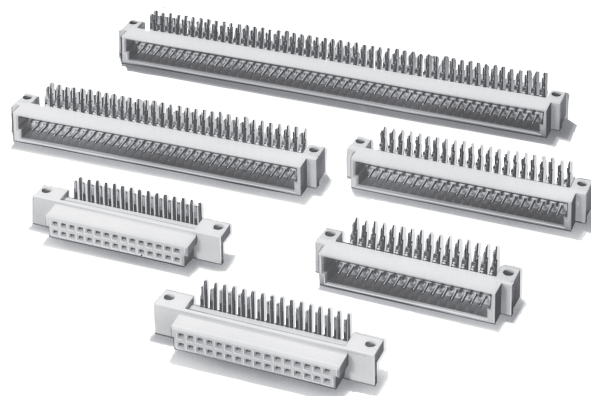

### ■ Ratings and Characteristics

Rated current	2 A
Rated voltage	300 VAC
Contact resistance	20 mΩ max. (at 20 mV, 100 mA max.)*
Insulation resistance	10 <sup>6</sup> MΩ min. (at 100 VDC)
Dielectric strength	1,000 VAC for 1 min (leakage current: 1 mA max.)
Total insertion force	0.59 N max. per contact
Removal force	0.15 N min. (with test gauge, t = 0.56 mm)
Insertion durability	50 times
Ambient operating temperature	-55 to 125°C (with no icing at low temperature)

\*The XC5K is 30mΩ max. (at 20 mV DC max., 100 mA max.)

### ■ Materials and Finish

Type	Plugs	Sockets
Housings	Fiber-glass reinforced PBT resin (UL94 V-0)/gray	
Contacts	Mating end	Phosphor bronze/nickel base, 0.15-μm gold plating
	Terminal	Phosphor bronze/nickel base, 2.0-μm tin plating

# XC5A Double-row Plugs, DIN Style 1

## ■ Dimensions

(unit: mm)

XC5A-□□82-1

(With right-angle DIP terminals)

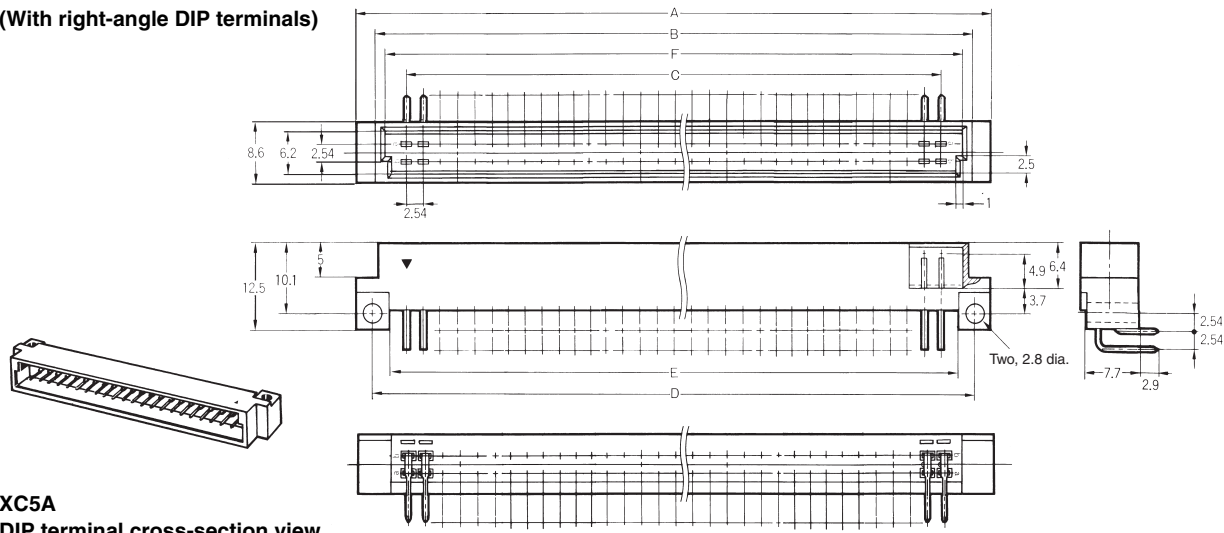

XC5A  
DIP terminal cross-section view

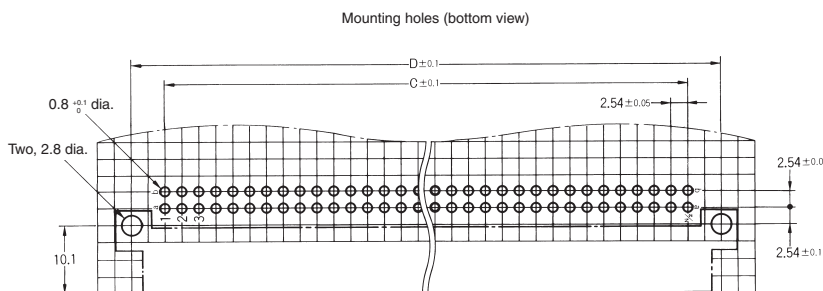
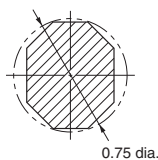

Note: Contact numbers are not marked on the product.

### Dimensions

No. of contacts	Dimensions (mm)					
	A	B	C	D	E	F
16	32.8	27.0	17.78	27.94	23.0	24.2
20	37.9	32.1	22.86	33.02	28.1	29.3
24	43.0	37.2	27.94	38.10	33.1	34.4
30	50.6	44.8	35.56	45.72	40.8	42.0
32	53.2	47.4	38.10	48.26	43.3	44.6
44	68.4	62.6	53.34	63.50	58.5	59.8

No. of contacts	Dimensions (mm)					
	A	B	C	D	E	F
50	76.0	70.2	60.96	71.12	66.2	67.4
64	93.8	88.0	78.74	88.90	83.9	85.2
100	139.5	133.7	124.46	134.62	129.7	130.9

## ■ Ordering Information

No. of contacts	Terminal type	Model
16	Right-angle DIP terminals	XC5A-1682-1
20		XC5A-2082-1
24		XC5A-2482-1
30		XC5A-3082-1
32		XC5A-3282-1
44		XC5A-4482-1
50		XC5A-5082-1
64		XC5A-6482-1
100		XC5A-0182-1

Note: These Connectors cannot be coded. There is no Coding Key available for them.

# XC5B Double-row Sockets, DIN-style Compatible

## ■ Dimensions

(unit: mm)

XC5B-□□31-0  
XC5B-□□31-3  
(With straight DIP terminals)

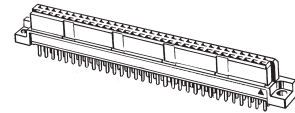

XC5B  
DIP terminal cross-section view

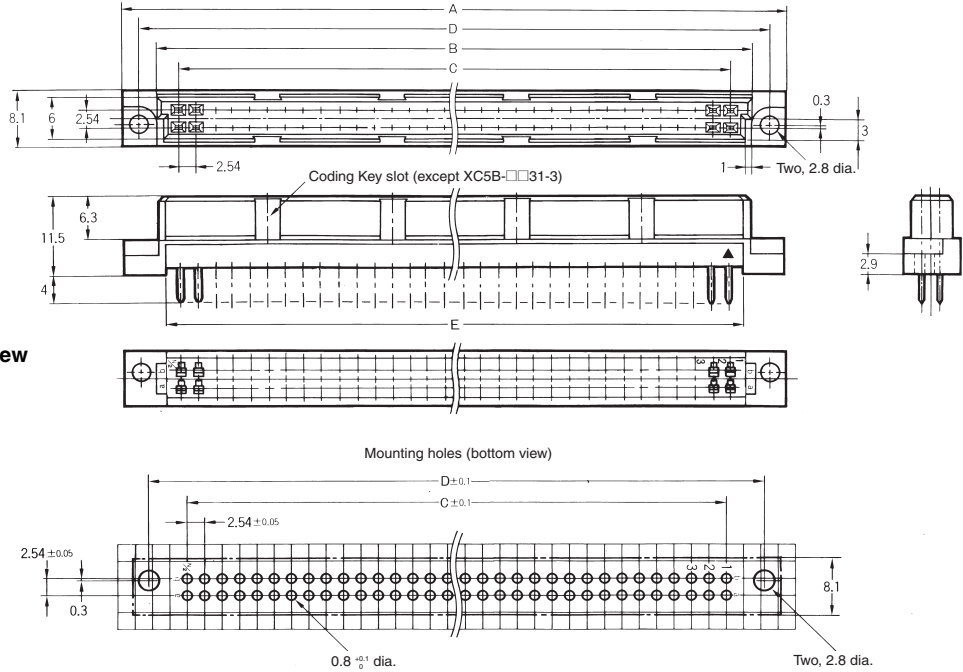
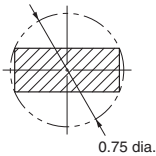

Note: Contact numbers are not marked on the product.

### Dimensions

No. of contacts	Dimensions (mm)					Coding Key slot positions (contact No.)
	A	B	C	D	E	
10	26.2	16.4	10.16	21.42	14.4	---
14	31.3	21.5	15.24	26.50	19.4	---
16	33.8	24.0	17.78	29.04	22.0	---
20	38.9	29.1	22.86	34.12	27.1	3, 8
24	44.0	34.2	27.94	39.20	32.1	---
30	51.6	41.8	35.56	46.82	39.8	---
32	54.2	44.4	38.10	49.36	42.3	5, 12

No. of contacts	Dimensions (mm)					Coding Key slot positions (contact No.)
	A	B	C	D	E	
44	69.4	59.6	53.34	64.60	57.5	4, 9, 14, 19
50	77.0	67.2	60.96	72.22	65.2	5, 10, 16, 21
64	94.8	85.0	78.74	90.00	82.9	6, 13, 20, 27
100	140.5	130.7	124.46	135.72	128.7	10, 20, 31, 41

## ■ Ordering Information

No. of contacts	Terminal type	Model
10	Straight DIP terminals	XC5B-1031-3
14		XC5B-1431-3
16		XC5B-1631-3
20		XC5B-2031-0
24		XC5B-2431-3
30		XC5B-3031-3
32		XC5B-3231-0
44		XC5B-4431-0
50		XC5B-5031-0
64		XC5B-6431-0
100	XC5B-0131-0	

Note: The XC5B-□□31-0 Connector with 20, 32, 44, 50, 64, or 100 contacts has the same housing as the standard DIN connector and has Coding Key slots, but these slots cannot be used. The 10-, 14-, 16-, 24- and 30- contact models (triple row) are custom-made so they do not have Coding Key slots.

# XC5E Double-row Plugs, DIN Style 2

## ■ Dimensions

(unit: mm)

(Dimensions are given for the XC5E-□□81-2. The dimensions and shape of the XC5E-□□81-3 are different.)

XC5E-□□81-2  
XC5E-□□81-3  
(With straight DIP terminals)

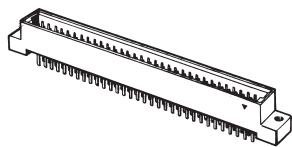

XC5E  
DIP terminal cross-section view

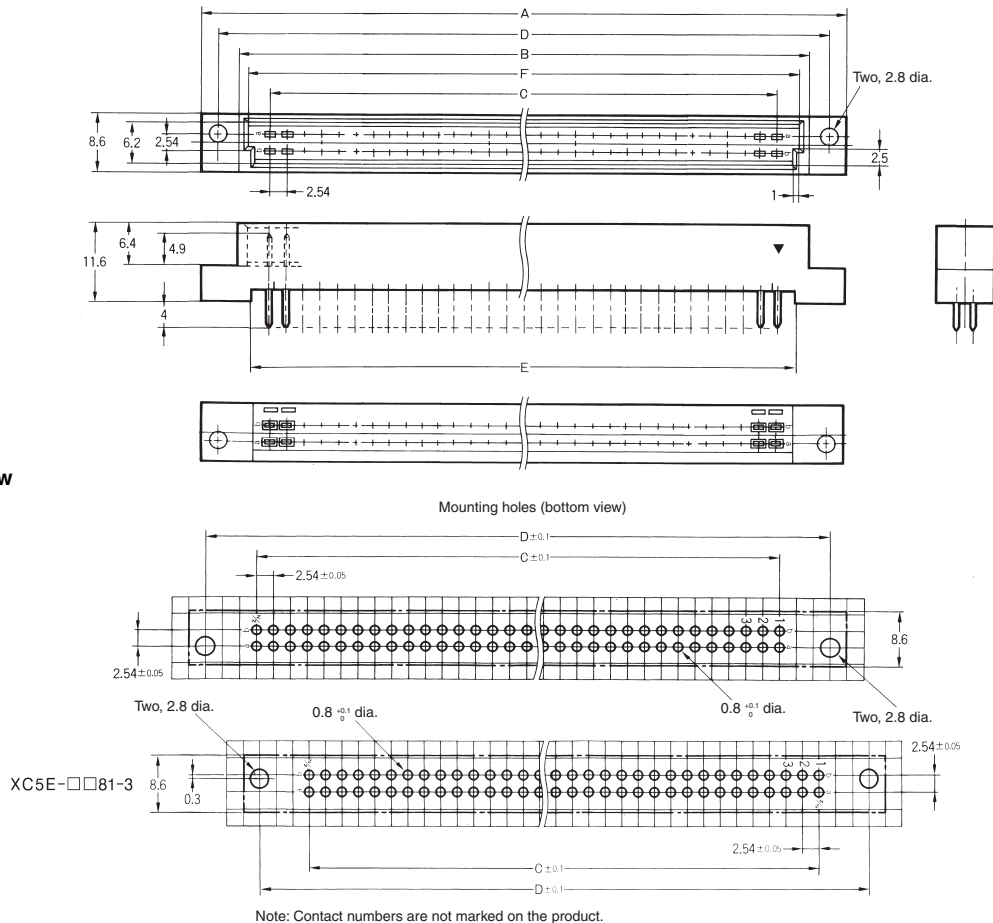

## Dimensions

No. of contacts	Dimensions (mm)					
	A	B	C	D	E	F
10*	26.2	19.4	10.16	21.42	15.4	16.6
14*	31.3	24.5	15.24	26.50	20.4	21.7
20	43.0	32.1	22.86	38.10	28.1	29.3
24*	44.0	37.2	27.94	39.20	33.1	34.4
30	55.7	44.8	35.56	50.80	40.8	42.0
32	58.2	47.4	38.10	53.34	43.3	44.6
44	73.5	62.6	53.34	68.58	58.5	59.8
50	81.1	70.2	60.96	76.20	66.2	67.4
64	98.9	88.0	78.74	93.98	83.9	85.2
100	144.6	133.7	124.46	139.70	129.7	130.9

**Note:** Marked items are XC5E-□□81-3. Contact your OMRON representative about mounting hole positions because they will vary with the model.

## ■ Ordering Information

No. of contacts	Terminal type	Model
10	Straight DIP terminals	XC5E-1081-3
14		XC5E-1481-3
20		XC5E-2081-2
24		XC5E-2481-3
30		XC5E-3081-2
32		XC5E-3281-2
44		XC5E-4481-2
50		XC5E-5081-2
64		XC5E-6481-2
100		XC5E-0181-2

**Note:** Coding with these Connectors is not possible because Coding Keys are not provided. The housing of the XC5E-□□81-2 is different from that of the XC5E-□□81-3. Both edges of the mating side of Triple-row Connectors are open.

# XC5F Double-row Sockets, DIN Style 2

## ■ Dimensions

(unit: mm)

XC5F-□□32-2

(With right-angle DIP terminals)

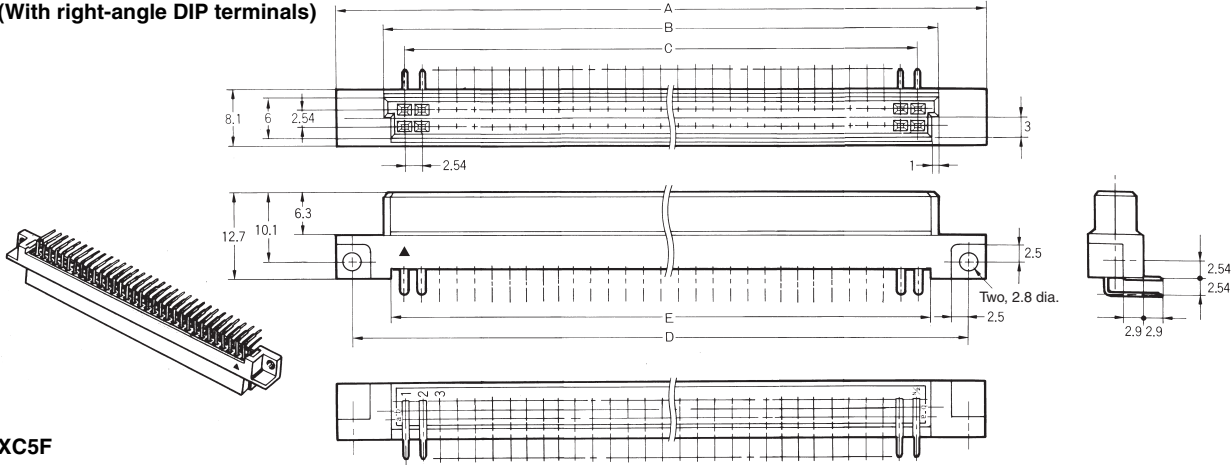

XC5F  
DIP terminal cross-section view

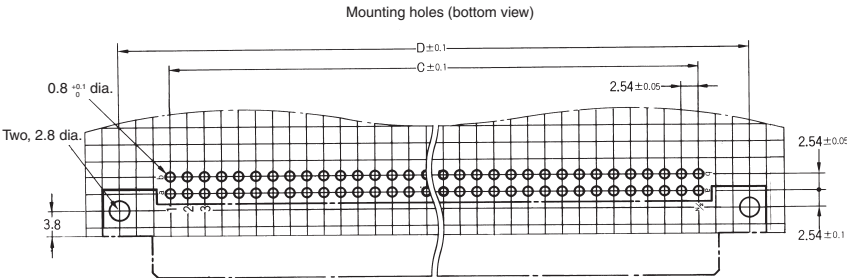
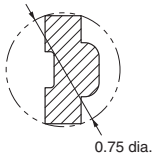

Note: Contact numbers are not marked on the product.

### Dimensions

No. of contacts	Dimensions (mm)				
	A	B	C	D	E
20	43.0	29.1	22.86	38.10	27.0
30	55.7	41.8	35.56	50.80	39.7
32	58.2	44.4	38.10	53.34	42.2
44	73.5	59.6	53.34	68.58	57.5

No. of contacts	Dimensions (mm)				
	A	B	C	D	E
50	81.1	67.2	60.96	76.20	65.2
64	98.9	85.0	78.74	93.98	82.9
100	144.6	130.7	124.46	139.70	128.7

## ■ Ordering Information

No. of contacts	Terminal type	Model
20	Right-angle DIP terminals	XC5F-2032-2
30		XC5F-3032-2
32		XC5F-3232-2
44		XC5F-4432-2
50		XC5F-5032-2
64		XC5F-6432-2
100		XC5F-0132-2

Note: These Connectors cannot be coded. There is no Coding Key available for them.

# XC5K Plugs with Large Stacking Space

## ■ Dimensions

(unit: mm)

XC5K-□□31-3A

(With straight DIP terminals with a stacking space of 30 mm)

XC5K-□□31-2A

(With straight DIP terminals with a stacking space of 25 mm)

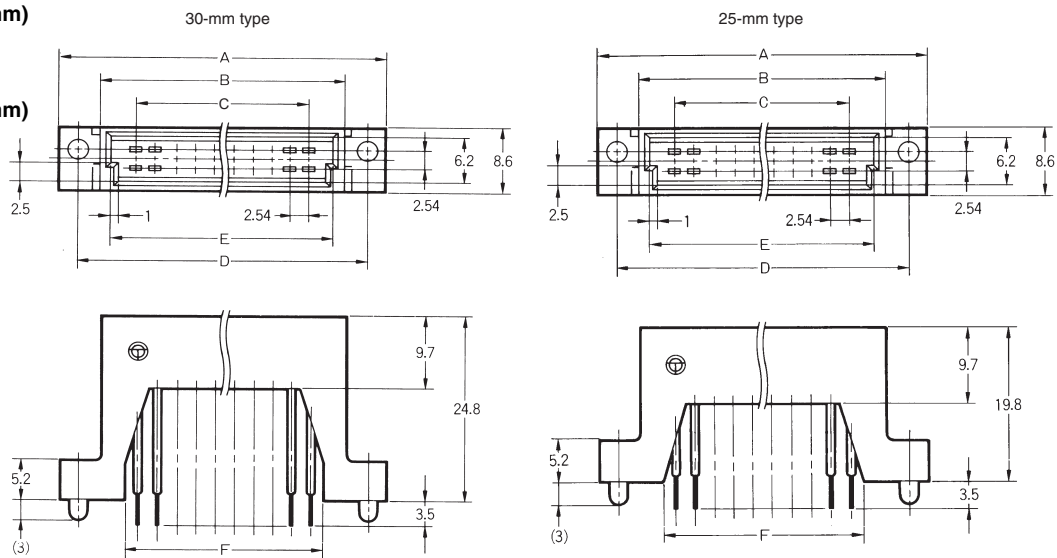

XC5K  
DIP terminal cross-section diagram

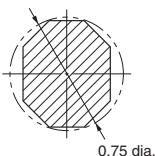

Mounting holes (bottom view)

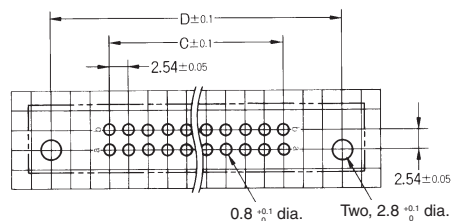

## Dimensions

No. of contacts	Dimensions (mm)					
	A	B	C	D	E	F
16	37.9	27.0	17.78	33.02	24.2	21.0
20	43.0	32.1	22.86	38.10	29.3	26.1
32	58.2	47.4	38.10	53.34	44.6	41.4

## ■ Ordering Information

No. of contacts	Stacking space: 30 mm	Stacking space: 25 mm	Mated Connector
16	XC5K-1631-3A	XC5K-1631-2A	XC5B-1631-3
20	XC5K-2031-3A	XC5K-2031-2A	XC5B-2031-0
32	XC5K-3231-3A	XC5K-3231-2A	XC5B-3231-0

# XC5C Triple-row Plugs, DIN Style 1

## ■ Dimensions

(unit: mm)

XC5C-□□82-1

(With right-angle DIP terminals)

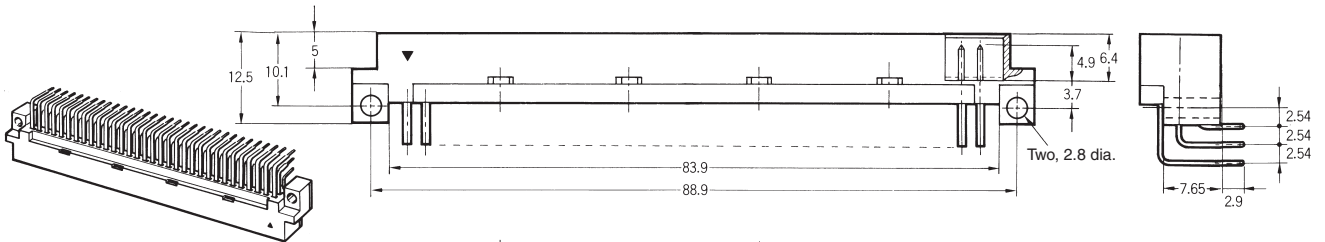
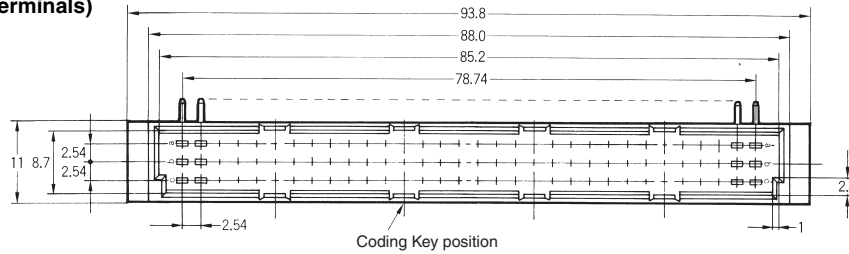

XC5C  
DIP terminal cross-section view

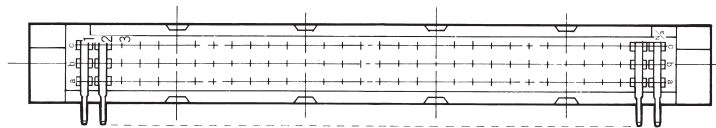
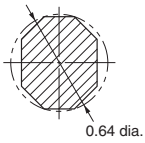

Mounting holes (bottom view)

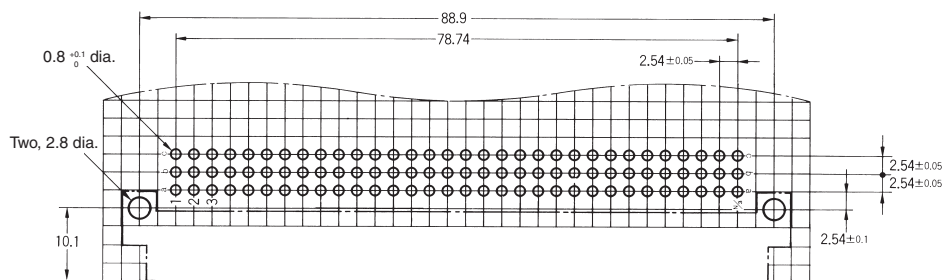

Note: The 64-contact plug does not have the center row (b in the above diagrams).  
Contact numbers are not marked on the product.

## ■ Ordering Information

No. of contacts	Terminal type	Model
64*	Right-angle DIP terminals	XC5C-6482-1
96		XC5C-9682-1

\*Has no center row (row b).

# XC5D Triple-row Sockets, DIN-style Compatible

## ■ Dimensions

(unit: mm)

XC5D-□□31-0  
(With straight DIP terminals)

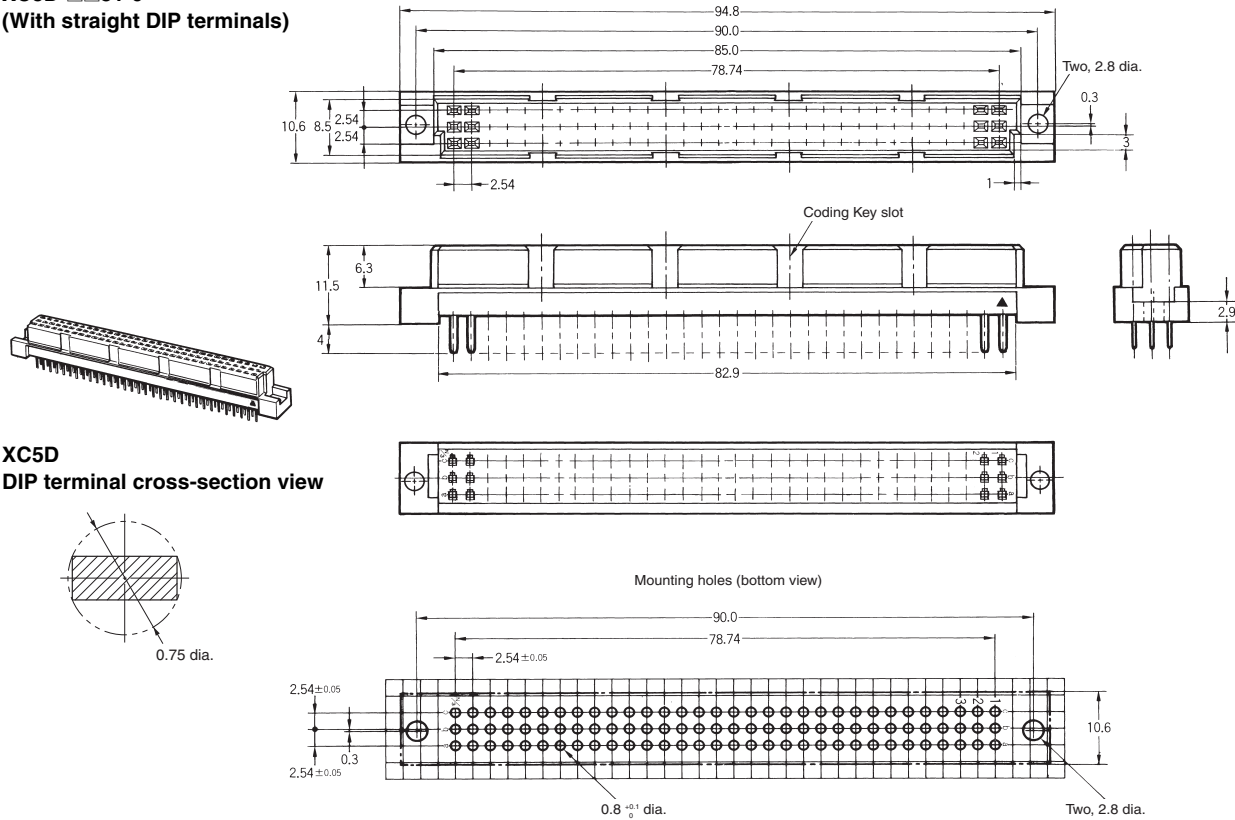

Note: The 64-contact plug does not have the center row (b in the above diagrams).  
Contact numbers are not marked on the product.

## ■ Ordering Information

No. of contacts	Terminal type	Model
64*	Straight DIP terminals	XC5D-6431-0
96		XC5D-9631-0

\*Has no center row (row b).



**Accessories (Sold Separately)**

**Clamping Bracket (Used exclusively for XC5K)**  
XC5Z-0007

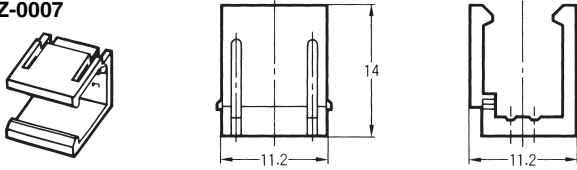

Material : Polyamide resin (UL94 V-2)/natural

After a Plug and Socket are mated with each other, they can be locked with the XC5Z-0007 Clamping Bracket in order to improve the vibration and shock resistance of the Connector.

<b>Model</b>
<b>XC5Z-0007</b>

**Mating Diagrams**

(unit: mm)

Item	Vertical (Standard)	Vertical (Reverse)	Stacking (See note.)	Horizontal (See note.)
Double-row Connectors				
Triple-row Connectors		---	---	---

**Note:** 1. By combining a Standard and a Reverse Connector, stacking and horizontal matings can be made. In this case, the triangular marks (terminal number 1) on the Plug and the Socket will not match.  
2. When mating XC5A-□□82-1 and XC5F-□□32-2 horizontally, the board is misaligned by 0.25 mm.

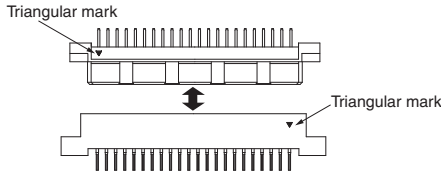

**Large Space Stacking (XC5K with XC5B)**

<p><b>Stacking space: 30 mm</b></p>	<p><b>Stacking space: 25 mm</b></p>
-------------------------------------	-------------------------------------

**Note:** The □□ in each model number are replaced with the number of contacts (16, 20, or 32). With 16 contacts, for example, the model number is XC5B-1631-3.

**Series of XC5 Products**

**XC5□-□□□□-A (with Fastening Pins)**

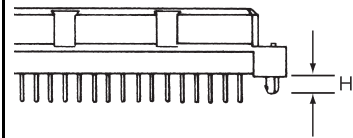

- OMRON's original round fastening pins support the terminals on a PCB securely.
- The pins securely supporting the terminals on a PCB enable smooth soldering and increase the mounting reliability of the terminals.
- The fastening pins are press-fit onto the Connector before shipment.
- Fastening pins can be attached to all XC5 models. (They cannot be attached to wrap terminals.)
- Standard fastening pins can be used on boards ranging in thickness from 1.6 mm to 2.2 mm.
- The fastening pin dimension H is 3 mm with straight terminals and 2.5 mm with right-angle terminals.

## ■ Precautions

### Correct Use

#### Circuit Board Mounting

Make sure that the mating area does not extend beyond the board edge.

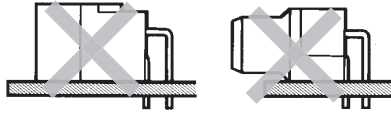

#### Automated Soldering Conditions (Jet Flow)

1. Soldering temperature: 250±5°C
2. Continuous soldering time: Within 5±1 s

## ■ Approval Standard

The approval rating values for overseas standards are different from the performance values determined individually. Confirm the values before use.

Model	Standard	File No.	Rating
XC5A-□□82-1	UL certified product (Recognized) CSA certified product (Certified)	E103202 LR 62678	300 V, 2 A
XC5A-1682-1	UL certified product (Recognized)	E103202	300 V, 2 A
XC5B-□□31-3	UL certified product (Recognized) CSA certified product (Certified)	E103202 LR 62678	300 V, 2 A
XC5B-1031-3	UL certified product (Recognized)	E103202	300 V, 2 A
XC5B-1431-3	UL certified product (Recognized)	E103202	300 V, 2 A
XC5B-1631-3	UL certified product (Recognized)	E103202	300 V, 2 A
XC5B-□□31-0	UL certified product (Recognized) CSA certified product (Certified)	E103202 LR 62678	300 V, 2 A
XC5E-□□81-3	UL certified product (Recognized) CSA certified product (Certified)	E103202 LR 62678	300 V, 2 A
XC5E-1081-3	UL certified product (Recognized)	E103202	300 V, 2 A
XC5E-1481-3	UL certified product (Recognized)	E103202	300 V, 2 A
XC5E-□□81-2	UL certified product (Recognized) CSA certified product (Certified)	E103202 LR 62678	300 V, 2 A
XC5F-□□32-2	UL certified product (Recognized) CSA certified product (Certified)	E103202 LR 62678	300 V, 2 A
XC5K-□□31-3A	Non Approved Models	---	---
XC5K-□□31-2A	Non Approved Models	---	---
XC5C-6482-1	UL certified product (Recognized) CSA certified product (Certified)	E103202 LR 62678	300 V, 2 A
XC5C-9682-1	UL certified product (Recognized) CSA certified product (Certified)	E103202 LR 62678	300 V, 2 A
XC5D-6431-0	UL certified product (Recognized) CSA certified product (Certified)	E103202 LR 62678	300 V, 2 A
XC5D-9631-0	UL certified product (Recognized) CSA certified product (Certified)	E103202 LR 62678	300 V, 2 A
XC5Z-0007	Non Approved Models	---	---



Please check each region's Terms & Conditions by region website.

---

**OMRON Corporation**  
Device & Module Solutions Company

**Regional Contact**

**Americas**

<https://components.omron.com/us>

**Asia-Pacific**

<https://components.omron.com/ap>

**Korea**

<https://components.omron.com/kr>

**Europe**

<https://components.omron.com/eu>

**China**

<https://components.omron.com.cn>

**Japan**

<https://components.omron.com/jp>

© OMRON Corporation 2012-2022 All Rights Reserved.  
In the interest of product improvement, specifications are subject to change without notice.

**Cat. No. G050-E1-04**  
0922 (0412)