

Flexible Safety Unit G9SX

J671-E-01

Logical AND Function Adds Flexibility to I/O Expansion

- Facilitates partial or complete control system setup.
- Solid-state outputs (excluding Expansion Units).
- Detailed LED indications enable easy diagnosis.
- TÜV SÜD certification for compliance with IEC/EN61508 (SIL3), EN ISO13849-1 (PLe/Safety Category 4).
- Approved by UL and CSA.
- New unit joins the Series with the following two additional features:
 - OFF-delay time of up to 150 seconds can be set.
 - Two logical AND connection inputs



Be sure to read the "Safety Precautions".



Application Examples

Parts Processing Machine

- The entire device stops when the emergency stop switch is pressed.
- Only the processing section stops when the Safety Light Curtain is interrupted.

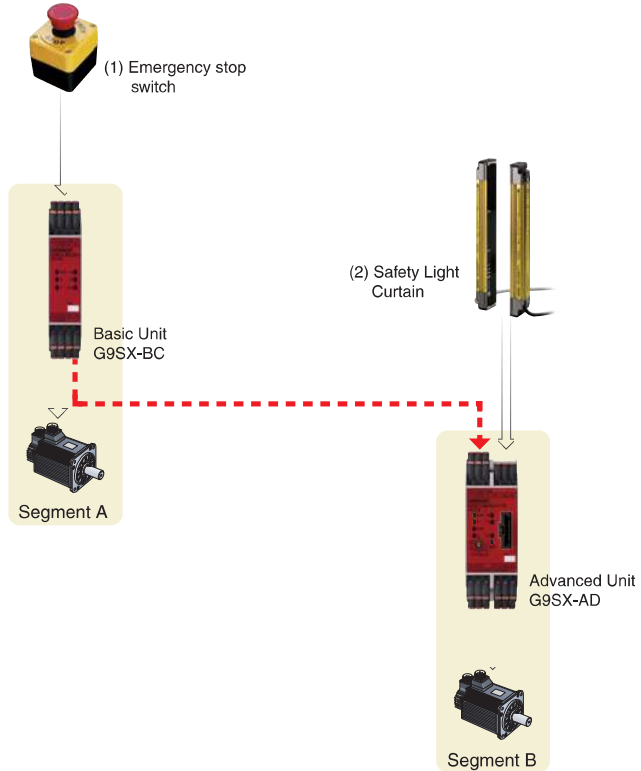
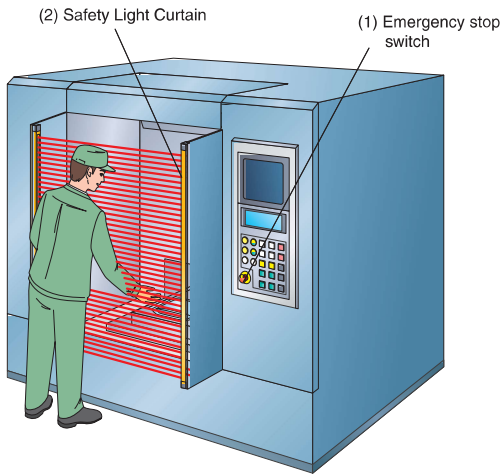

Operating Example

- (1) The emergency stop switch is pressed. (2) Safety Light Curtain is interrupted.



Machining Center

- When the Emergency Stop Switch is pressed, the entire machine will stop.
- When a door is open, the corresponding part will not be activated.

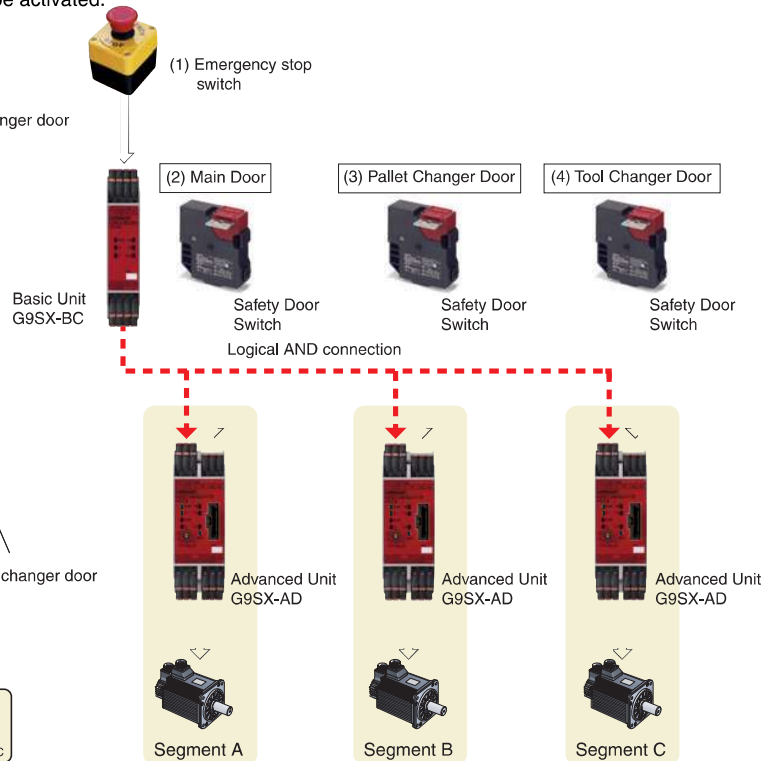
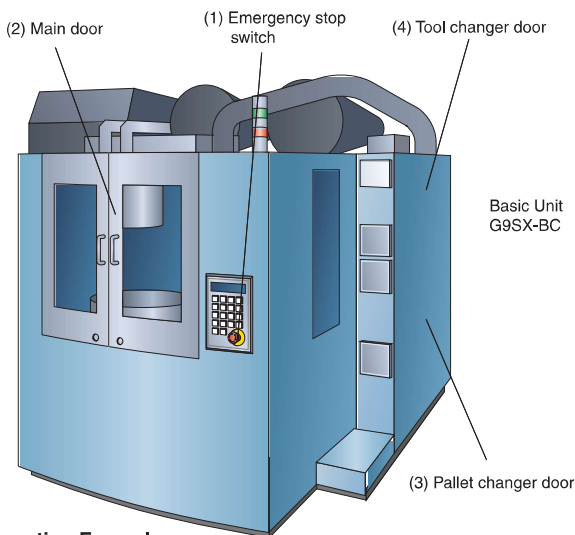

Operating Example

- (1) The emergency stop switch is pressed. (2) The main door is opened.

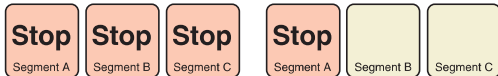

- (3) The pallet changer door is opened. (4) The tool changer door is opened.

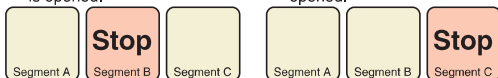

Semiconductor Manufacturing Equipment

- All of the equipment stops when the emergency stop switch is pressed.
- The processing section and conveyor section stop when the processing section cover is opened.
- Only the conveyor section stops when the conveyor section cover is opened.

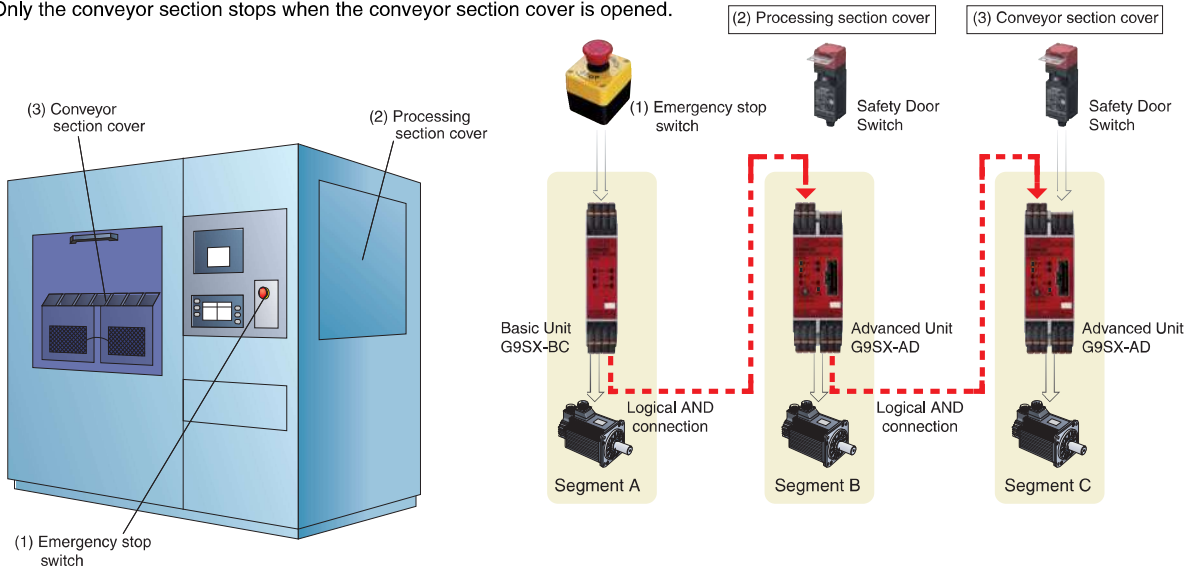

Operating Example

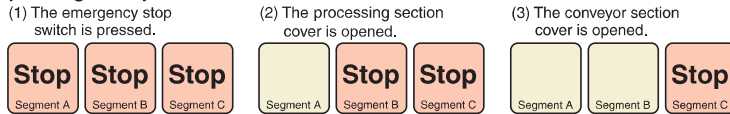

Machine Tool

- When the Emergency Stop Switch is pressed, the entire machine will stop.
- If the left door is opened, the left drive section and transport section will stop.
- If the right door is opened, the right drive section and transport section will stop.

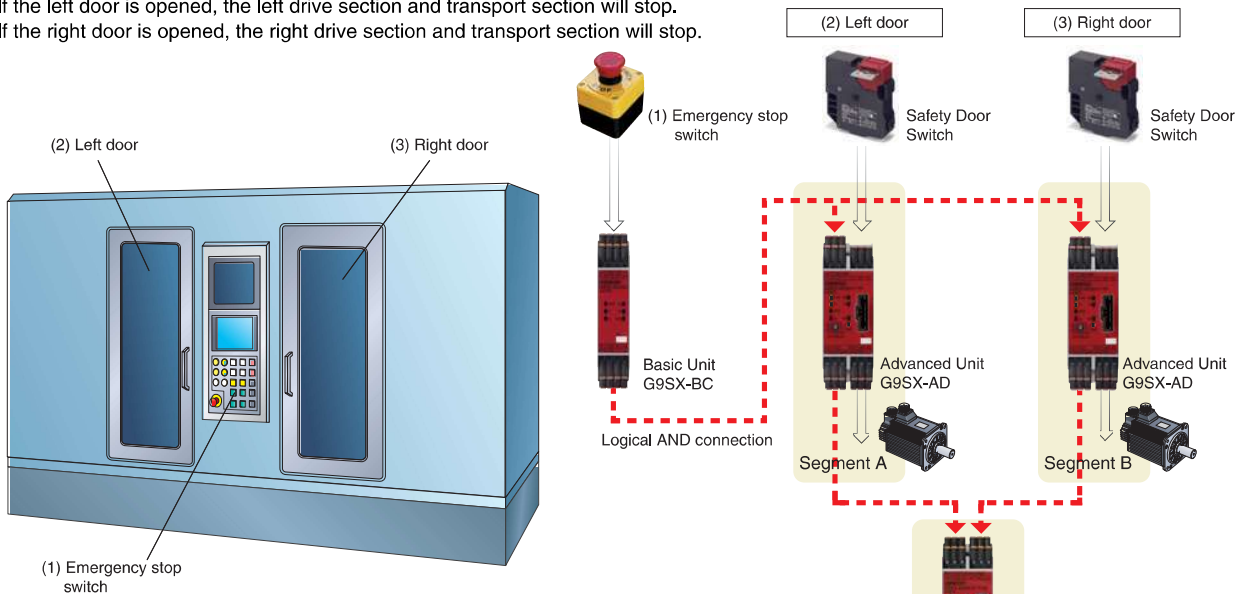

Operating Example

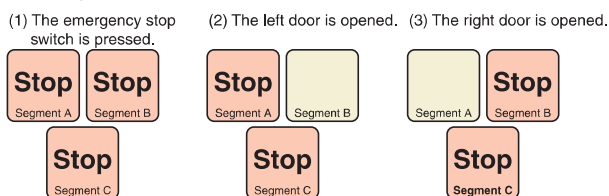

Model Number Structure

Model Number Legend

G9SX-□□□□□□-□□□□-□□
 1 2 3 4 5 6

Note: Please see "Ordering Information" below for the actual models that can be ordered.

1. Functions

AD/ADA: Advanced Unit
 BC: Basic Unit
 EX: Expansion Unit

2. Output Configuration (Instantaneous Safety Outputs)

0: None
 2: 2 outputs
 3: 3 outputs
 4: 4 outputs

3. Output Configuration (OFF-delayed Safety Outputs)

0: None
 2: 2 outputs
 4: 4 outputs

4. Output Configuration (Auxiliary Outputs)

1: 1 output
 2: 2 outputs

5. Max. OFF-delay Time

Advanced Unit
 T15: 15 s
 T150: 150 s
 Basic Unit
 No indicator: No OFF delay
 Expansion Unit
 No indicator: No OFF delay
 T: OFF delay

6. Terminal Block Type

RT: Screw terminals
 RC: Spring-cage terminals

Ordering Information

List of Models

Advanced Unit

Safety outputs *3		Auxiliary outputs *4	Logical AND connection		No. of input channels	Max. OFF-delay time *1	Rated voltage	Terminal block type	Model
Instantaneous	OFF-delayed *2		Inputs	Outputs					
3 (Semiconductor)	2 (Semiconductor)	2 (Semiconductor)	1 (Semi-conductor)	1 (Semi-conductor)	1 or 2 channels	15 s	24 VDC	Screw terminals	G9SX-AD322-T15-RT
								Spring-cage terminals	G9SX-AD322-T15-RC
2 (Semiconductor)	2 (Semiconductor)	2 (Semiconductor)	2 (Semi-conductor)	2 (Semi-conductor)	1 or 2 channels	15 s	24 VDC	Screw terminals	G9SX-AD322-T150-RT
								Spring-cage terminals	G9SX-AD322-T150-RC
								Screw terminals	G9SX-ADA222-T15-RT
								Spring-cage terminals	G9SX-ADA222-T15-RC
						150 s	24 VDC	Screw terminals	G9SX-ADA222-T150-RT
								Spring-cage terminals	G9SX-ADA222-T150-RC

*1. The OFF-delay time can be set in 16 steps as follows:

T15: 0/0.2/0.3/0.4/0.5/0.6/0.7/1/1.5/2/3/4/5/7/10/15 s

T150: 0/10/20/30/40/50/60/70/80/90/100/110/120/130/140/150 s

*2. The OFF-delayed output becomes an instantaneous output by setting the OFF-delay time to 0 s.

*3. P channel MOS-FET output

*4. PNP transistor output

Basic Unit

Safety outputs *1		Auxiliary outputs *2	No. of input channels	Rated voltage	Terminal block type	Model
Instantaneous	OFF-delayed					
2	---	2 (Semiconductor)	1 or 2 channels	24 VDC	Screw terminals	G9SX-BC202-RT
					Spring-cage terminals	G9SX-BC202-RC

*1. P channel MOS-FET output

*2. PNP transistor output

Expansion Unit

Safety outputs		Auxiliary outputs *1	OFF-delay time	Rated voltage	Terminal block type	Model
Instantaneous	OFF-delayed					
4 PST-NO	---	1 (Semiconductor)	---	24 VDC	Screw terminals	G9SX-EX401-RT
			*2		Spring-cage terminals	G9SX-EX401-RC
---	4 PST-NO				Screw terminals	G9SX-EX041-T-RT
					Spring-cage terminals	G9SX-EX041-T-RC

*1. PNP transistor output

*2. The OFF-delay time is synchronized to the OFF-delay time setting in the connected Advanced Unit (G9SX-AD-□/G9SX-ADA-□).

Accessories

Terminal Block

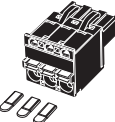
Appearance *	Specifications	Applicable units	Model	Remarks
	Terminal Block with screw terminals (3-pin)	G9SX-AD-□ G9SX-ADA-□	Y9S-03T1B-02A	Two Terminal Blocks (black) with screw terminals, and a set of six code marks to prevent erroneous insertion.
	Terminal Block with screw terminals (4-pin)	G9SX-BC-□ G9SX-EX-□	Y9S-04T1B-02A	Two Terminal Blocks (black) with screw terminals, and a set of six code marks to prevent erroneous insertion.
	Terminal Block with spring-cage terminals (3-pin)	G9SX-AD-□ G9SX-ADA-□	Y9S-03C1B-02A	Two Terminal Blocks (black) with spring-cage terminals, and a set of six code marks to prevent erroneous insertion.
	Terminal Block with spring-cage terminals (4-pin)	G9SX-BC-□ G9SX-EX-□	Y9S-04C1B-02A	Two Terminal Blocks (black) with spring-cage terminals, and a set of six code marks to prevent erroneous insertion.

Note: The G9SX main unit comes with a terminal block as standard equipment. The accessories shown here can be ordered as a replacement.
* The illustrations show 3-pin types

Specifications

Ratings

Power input

Item	Model	G9SX-AD322-□/ADA222-□	G9SX-BC202-□	G9SX-EX-□
Rated supply voltage		24 VDC		
Operating voltage range		-15% to 10% of rated supply voltage		
Rated power consumption *		4 W max.	3 W max.	2 W max.

* Power consumption of loads not included.

Inputs

Item	Model	G9SX-AD322-□/ADA222-□	G9SX-BC202-□
Safety input		Operating voltage: 20.4 VDC to 26.4 VDC, internal impedance: approx. 2.8 kΩ *	
Feedback/reset input			

* Provide a current equal to or higher than that of the minimum applicable load of the connected input control device.

Outputs

Item	Model	G9SX-AD322-□/ADA222-□	G9SX-BC202-□
Instantaneous safety output *1 OFF-delayed safety output *1		P channel MOS-FET output Load current: 0.8 A DC max./output *2 *3	P channel MOS-FET output Load current: 0.8 A DC max./output *2 *3
Auxiliary output		PNP transistor output Load current: 100 mA max./output	

*1. While safety outputs are in the ON state, the following signal sequence is output continuously for diagnosis. When using the safety outputs as input signals to control devices (i.e. Programmable Controllers), consider the OFF pulse shown below.

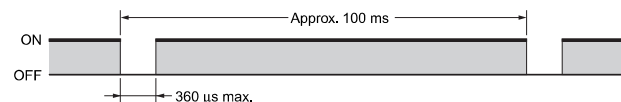

*2. The following derating is required when Units are mounted side-by-side.

G9SX-AD322-□/G9SX-ADA222-□/G9SX-BC202-□: 0.4 A max. load current/output

*3. A load current below 1 A DC/output can be used when the following outputs are used.

G9SX-AD322-□/G9SX-ADA222-□: 2 outputs or less

G9SX-BC202-□: 1 output

Expansion Unit Ratings

Item	Model	G9SX-EX-□
Rated load		250 VAC, 3 A/30 VDC, 3 A (resistive load)
Rated carry current		3 A
Maximum switching voltage		250 VAC, 125 VDC

Characteristics

Item	Model	G9SX-AD322-□/ADA222-□	G9SX-BC202-□	G9SX-EX-□
Overvoltage category (IEC/EN 60664-1)		II		II (Safety relay outputs 13 to 43 and 14 to 44: III)
Operating time (OFF to ON state) *1		50 ms max. (Safety input: ON) *2 100 ms max. (Logical AND connection input: ON) *3	50 ms max. (Safety input: ON)	30 ms max. *4
Response time (ON to OFF state) *1		15 ms max.		10 ms max. *4
ON-state residual voltage		3,0 V max. (safety output, auxiliary output)		
OFF-state leakage current		0,1 mA max. (safety output, auxiliary output)		
Maximum wiring length of safety input and logic AND input		100 m max. (External connection impedance: 100 Ω max. and 10 nF max.)		
Reset input time (Reset button pressing time)		100 ms min.		
Accuracy of OFF-delay time *5		Within ± 5% of the set value	---	Within ± 5% of the set value
Insulation resistance	Between logical AND connection terminals, and power supply input terminals and other input and output terminals connected together	20 MΩ min. (at 100 VDC)	---	---
	Between all terminals connected together and DIN track		20 MΩ min. (at 100 VDC)	100 MΩ min. (at 500 VDC)
Dielectric strength	Between logical AND connection terminals, and power supply input terminals and other input and output terminals connected together	500 VAC for 1 min	---	---
	Between all terminals connected together and DIN track		500 VAC for 1 min	1,200 VAC for 1 min
	Between different poles of outputs	---	---	
	Between safety relay outputs connected together and other terminals connected together	---	---	
Vibration resistance		Frequency: 10 to 55 to 10 Hz, 0,375-mm single amplitude (0,75-mm double amplitude)		
Shock resistance	Destruction	300 m/s ²		
	Malfunction	100 m/s ²		
Durability	Electrical	---		100,000 cycles min. (rated load, switching frequency: 1,800 cycles/hour)
	Mechanical	---		5,000,000 cycles min. (switching frequency: 7,200 cycles/hour)
Ambient operating temperature		-10 to 55°C (with no icing or condensation)		
Ambient operating humidity		25% to 85%		
Terminal tightening torque *6		0,5 N·m		
Weight		Approx. 200 g	Approx. 125 g	Approx. 165 g

*1. When two or more Units are connected by logical AND, the operating time and response time are the sum total of the operating times and response times, respectively, of all the Units connected by logical AND.

*2. Represents the operating time when the safety input turns ON with all other conditions set.

*3. Represents the operating time when the logical AND input turns ON with all other conditions set.

*4. This does not include the operating time or response time of Advanced Units that are connected.

*5. This does not include the operating time or response time of internal relays in the G9SX-EX-□.

*6. For the G9SX-□-RT (with screw terminals) only.

Logical AND Connection

Item	Model	G9SX-AD322-□/ADA222-□	G9SX-BC202-□	G9SX-EX-□
Number of Units connected per logical AND output		4 Units max.		---
Total number of Units connected by logical AND #1		20 Units max.		---
Number of Units connected in series by logical AND		5 Units max.		---
Max. number of Expansion Units connected #2		---		5 Units max.
Maximum cable length for logical AND input		100 m max./output		---

Note: See Logical AND Connection Combinations below for details.

***1.** The number of G9SX-EX401-□ Expansion Units or G9SX-EX041-T-□ Expansion Units (OFF-delayed Model) not included.

***2.** G9SX-EX401-□ Expansion Units and G9SX-EX041-T-□ Expansion Units (OFF-delayed Model) can be mixed.

Logical AND Connection Combinations

- One logical AND connection output from an Advanced Unit G9SX-AD can be logical AND connected to up to four Advanced Units.

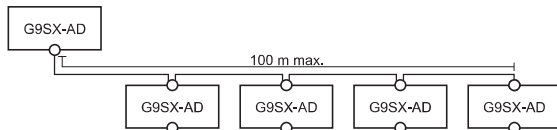

- Two logical AND outputs from a Basic Unit G9SX-BC can be logical AND connected to up to eight Advanced Units.

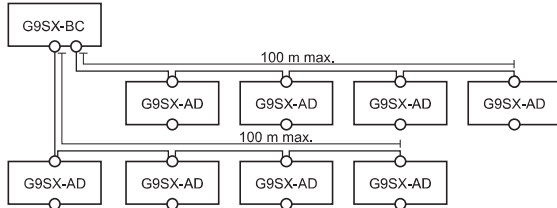

- Two logical AND outputs from an Advanced Unit G9SX-ADA can be logical AND connected to up to eight Advanced Units.

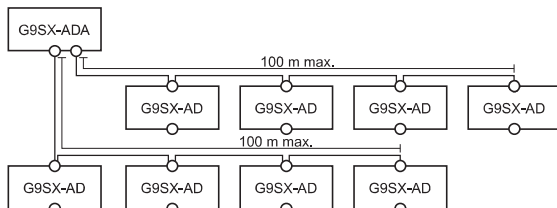

- Any Advanced Unit with logical AND input can be logical AND connected to Advanced Units on up to five tiers.

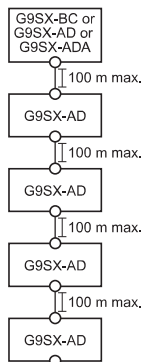

- Two logical AND connection outputs, each from different Advanced/Basic Units, can be logical AND connected to a single G9SX-ADA Unit.

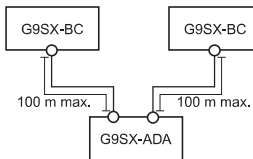



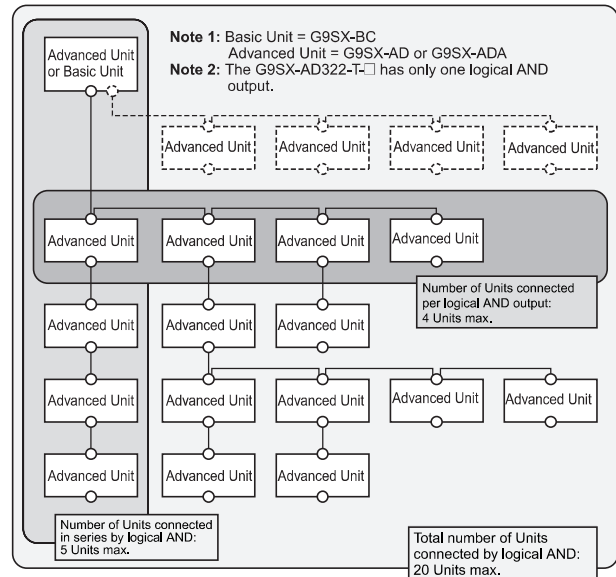

- The largest possible system configuration contains a total of 20 Advanced and Basic Units. In this configuration, each Advanced Unit can have up to five Expansion Units.

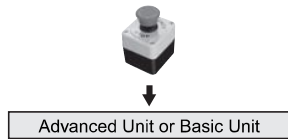

Response Time and Operating Time

The following table shows the response time for two or more Units that are logical AND connected.

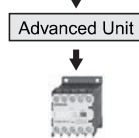
Tier	Item	Block flow diagram	Max. response time #1 (not including Expansion Units)	Max. response time #2 (including Expansion Units)	Max. operating time #3 (not including Expansion Units)	Max. operating time #4 (including Expansion Units)
First tier			15 ms	25 ms	50 ms	80 ms
Second tier			30 ms	40 ms	150 ms	180 ms
Third tier			45 ms	55 ms	250 ms	280 ms
Fourth tier			60 ms	70 ms	350 ms	380 ms
Fifth tier			75 ms	85 ms	450 ms	480 ms

- *1. The maximum response time (not including Expansion Units) in this block flow diagram is the time it takes the output from the Unit on the lowest tier to switch from ON to OFF after the input to the Unit on the highest tier switches from ON to OFF.
- *2. The maximum response time (including Expansion Units) in this block flow diagram is the time it takes the output from the Expansion Unit connected to the Unit on the lowest tier to switch from ON to OFF after the input to the Unit on the highest tier switches from ON to OFF.
- *3. The maximum operating time (not including Expansion Units) in this block flow diagram is the time it takes the output from the Unit on the lowest tier to switch from OFF to ON after the input to the Unit on the highest tier switches from OFF to ON.
- *4. The maximum operating time (including Expansion Units) in this block flow diagram is the time it takes the output from the Expansion Unit connected to the Unit on the lowest tier to switch from OFF to ON after the input to the Unit on the highest tier switches from OFF to ON.

Connections

Internal Connection

G9SX-AD322-□ (Advanced Unit)

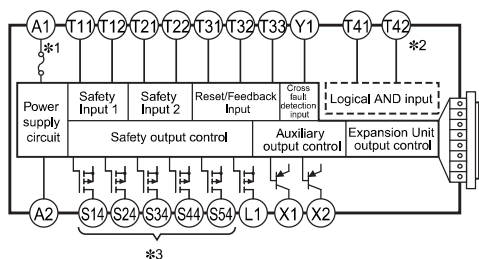

- *1. Internal power supply circuit is not isolated.
- *2. Logical AND input is isolated.
- *3. Outputs S14 to S54 are internally redundant.

G9SX-ADA222-□ (Advanced Unit)

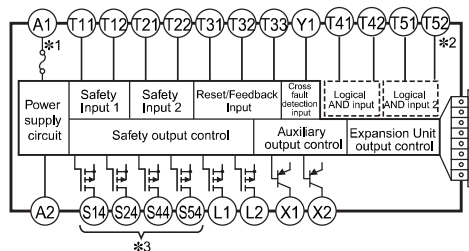

- *1. Internal power supply circuit is not isolated.
- *2. Logical AND inputs are isolated.
- *3. Outputs S14 to S54 are internally redundant.

G9SX-BC202-□ (Basic Unit)

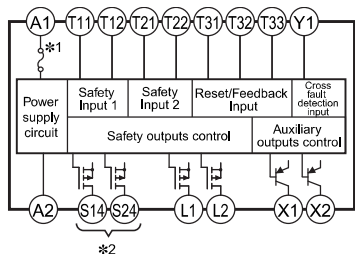

- *1. Internal power supply circuit is not isolated.
- *2. Outputs S14 and S24 are internally redundant.

G9SX-EX401-□/G9SX-EX041-T-□ (Expansion Unit / Expansion Unit OFF-delayed model)

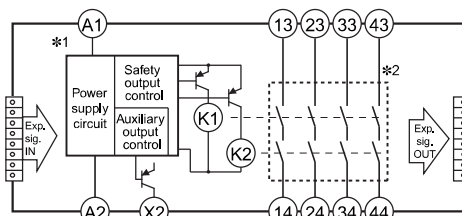

- *1. Internal power supply circuit is not isolated.
- *2. Relay outputs are isolated.

Wiring of Inputs and Outputs

Signal name	Terminal name	Description of operation	Wiring
Power supply input	A1, A2	The input terminals for power supply. Connect the power source to the A1 and A2 terminals.	Connect the power supply plus (24 VDC) to the A1 terminal. Connect the power supply minus (GND) to the A2 terminal.
Safety input 1	T11, T12		Using 1 safety input channel
Safety input 2	T21, T22	To set the safety outputs in the ON state, the ON state signals must be input to both safety input 1 and safety input 2. Otherwise the safety outputs cannot be in the ON state.	Using 2 safety input channels (cross fault detection OFF)
			Using 2 safety input channels (cross fault detection ON)
Feedback/reset input	T31, T32, T33	To set the safety outputs in the ON state, the ON state signal must be input to T33. Otherwise the safety outputs cannot be in the ON state.	Auto reset
		To set the safety outputs in the ON state, the signal input to T32 must change from the OFF state to the ON state, and then to the OFF state. Otherwise the safety outputs cannot be in the ON state.	Manual reset
Logical AND connection input	T41, T42, T51, T52	A logical AND connection means that one unit (Unit A) outputs a safety signal "a" to a subsequent unit (Unit B) and Unit B calculates the logical multiplication (AND) (i.e., outputs the AND) of the signal "a" and safety signal "b", which is input to Unit B. Thereby the logic of the safety output of Unit B is "a" AND "b". (An AND of inputs "a" and "b" is output.) To set the safety outputs of the subsequent Unit in the ON state, its logical AND connection preset switch must be set to AND (enable) and the HIGH state signal must be input to T41 of the subsequent unit.	
Cross fault detection input	Y1	Selects the mode for the failure detecting (cross fault detecting) function for the safety inputs of G9SX corresponding to the connection of the cross fault detection input.	Y1 connection varies depending on whether T11 and T21 are used or not. Refer to wiring of the safety input 1 and 2.
Instantaneous safety output	S14, S24, S34	Turns ON/OFF according to the state of the safety inputs, feedback/reset inputs, and logical AND connection inputs. During OFF-delay state, the Instantaneous safety outputs are not able to turn ON.	Keep these outputs open when not used.
OFF-delayed safety output	S44, S54	OFF-delayed safety outputs. The OFF-delay time is set by the OFF-delay preset switch. When the delay time is set to zero, these outputs can be used as instantaneous safety outputs.	Keep these outputs open when not used.
Logical AND connection output	L1, L2	Outputs a signal of the same logic as the instantaneous safety outputs.	Keep these outputs open when not used.
Auxiliary monitor output	X1	Outputs a signal of the same logic as the instantaneous safety outputs	Keep these outputs open when not used.
Auxiliary error output	X2	Outputs when the error indicator is lit or blinking.	Keep these outputs open when not used.

Connecting Safety Sensors and the G9SX

- When connecting safety sensors to the G9SX, the Y1 terminal must be connected to 24 VDC.
The G9SX will detect a connection error, if the Y1 terminal is open.
- In many cases, safety sensor outputs include an OFF-shot pulse for self diagnosis.
The following condition of test pulse is applicable as safety inputs for the G9SX.
 - OFF-shot pulse width of the sensor, during the ON-state: 340 μ s max.



Operation

Functions

Logical AND Connection

● Example with G9SX-AD322-□

The logical AND connection means that the Basic Unit (or Advanced Unit) outputs a safety signal “a” to an Advanced Unit, and the Advanced Unit calculates the logical multiplication (AND) of the safety signal “a” and safety signal “b.” The safety output of an Advanced Unit with the logical AND connection shown in the following diagram is “a AND b”.

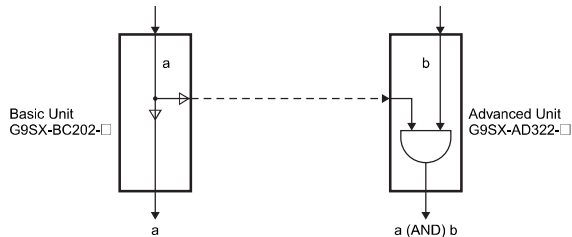

This is illustrated using the application in the following diagram as an example. The equipment here has two hazards identified as Robot 1 and Robot 2, and it is equipped with a safety door switch and an emergency stop switch. You may have overall control where both Robot 1 and Robot 2 are stopped every time the emergency stop switch is pressed. You may also have partial control where only Robot 1, which is closest to the door, is stopped when the door is opened. In that case, Robot 2 will continue to operate. The actual situation using a G9SX for this application is shown in this example.

(Note: The logical AND setting on the Advanced Unit must be set to AND (enabled).)

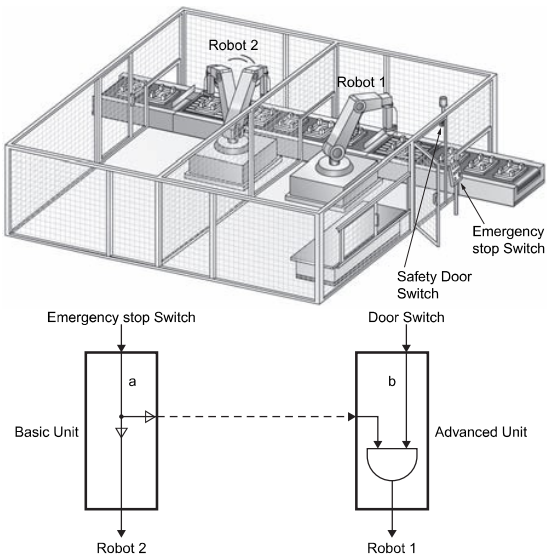

● Example with G9SX-ADA222-□

The Advanced Unit G9SX-ADA222-□ is equipped with two logical AND connection inputs. Therefore, it is capable of receiving two safety signals, each from different Advanced or Basic Units. As shown in the diagram below, the output of Advanced Unit G9SX-ADA222-□ will be “a AND b AND c”.

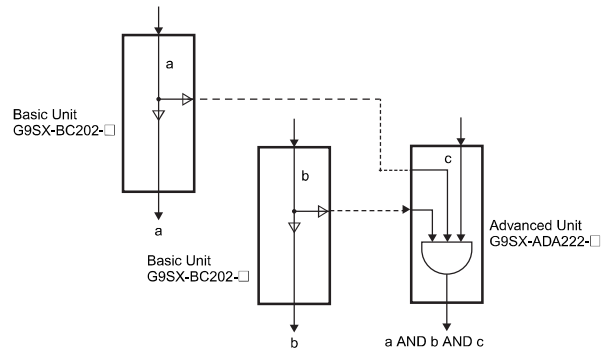

Connecting Expansion Units

- The G9SX-EX and G9SX-EX-T Expansion Units can be connected to an Advanced Unit (G9SX-AD322-□/G9SX-ADA222-□) to increase the number of safety outputs. (They cannot be connected to a Basic Unit.)
- A maximum of five Expansion Units can be connected to one Advanced Unit. This may be a combination of G9SX-EX Instantaneous types and G9SX-EX-T OFF-delayed types.
- Remove the terminating connector from the receptacle on the Advanced Unit and insert the Expansion Unit cable connector into the receptacle. Insert the terminating connector into the receptacle on the Expansion Unit at the very end (rightmost).
- When Expansion Units are connected to an Advanced Unit, make sure that power is supplied to every Expansion Unit. (Refer to the following diagram for actual Expansion Unit connection.)

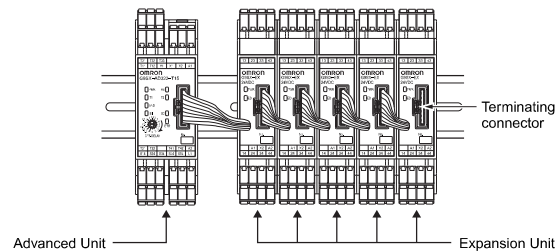

Setting Procedure

1. Cross Fault Detection (Advanced Unit/Basic Unit)

Set the cross fault detection mode for safety inputs by shorting Y1 to 24 V or leaving it open. When cross fault detection is set to ON, short-circuit failures are detected between safety inputs T11-T12 and T21-22. When a cross fault is detected, the following will occur.

1. The safety outputs and logical AND outputs lock out.
2. The LED error indicator is lit.
3. The error output (auxiliary output) turns ON.

Cross fault detection	Wiring	
OFF	Using 1 safety input channel	
	Using 2 safety input channels	
ON		

2. Reset Mode (Advanced Unit/Basic Unit)

Set the reset mode using feedback/reset input terminals T31, T32, and T33.

Auto reset mode is selected when terminal T32 is shorted to 24 V and manual reset mode is selected when terminal T33 is shorted to 24 V.

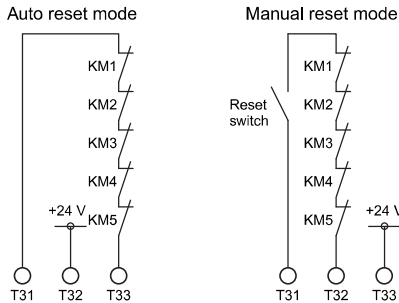

3. Setting Logical AND Connection (Advanced Unit)

When connecting two or more Advanced Units (or Basic Units) by logical AND connection, set the logical AND connection preset switch on the Advanced Unit that is on the input side (Advanced Unit G9SX-AD322 in the following diagram) to AND.

The default setting of the logical AND connection preset switch is set to OFF.

(1) Using G9SX-AD322 on the Input Side

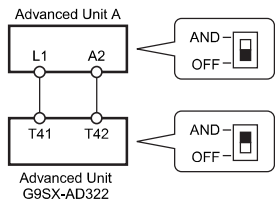

- Note:**
1. A setting error will occur and Advanced Unit G9SX-AD322 will lock out if the logical AND setting switch on the Unit is set to OFF.
 2. Set the logical AND setting switch on Advanced Unit A to OFF or an error will occur.
 3. A logical AND input cannot be sent to a Basic Unit.

(2) Using G9SX-ADA222 on the Input Side

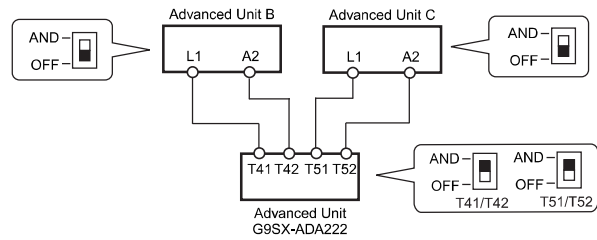

- Note:**
1. When not connecting Advanced Unit B, leave terminals T41 and T42 of the G9SX-ADA222 Advanced Unit open, and set the logical AND setting switch T41/T42 to OFF.
 2. When not connecting Advanced Unit C, leave terminals T51 and T52 of the G9SX-ADA222 Advanced Unit open, and set the logical AND setting switch T51/T52 to OFF.

The following table shows the relationship between the logical ON setting switches and the conditions for safety outputs turning ON.

Logical AND connection preset switch		Conditions for safety outputs turning ON		
T41/T42	T51/T52	Safety input	Logic input 1	Logic input 2
OFF	OFF	ON	OFF	OFF
AND	OFF	ON	ON	OFF
OFF	AND	ON	OFF	ON
AND	AND	ON	ON	ON

4. Setting the OFF-delay Time (Advanced Unit)

The OFF-delay preset time on an Advanced Unit is set from the OFF-delay time preset switch (1 each on the front and back of the Unit). Normal operation will only occur if both switches are identically set. An error will occur if the switches are not identically set.

The default setting of the OFF-delay time preset switch is set to 0 s.

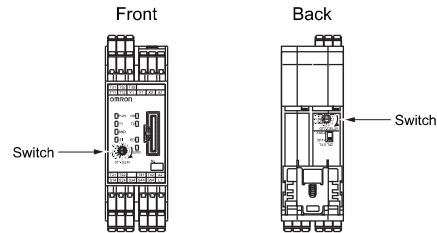

Refer to the following illustration for details on setting switch positions.

G9SX-AD322-T15/G9SX-ADA222-T15

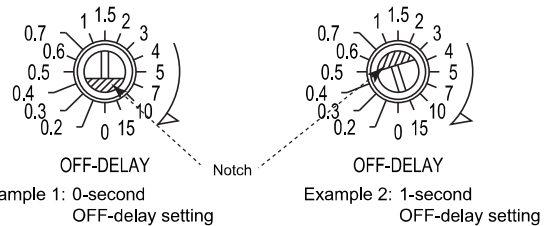

G9SX-AD322-T150/G9SX-ADA222-T150

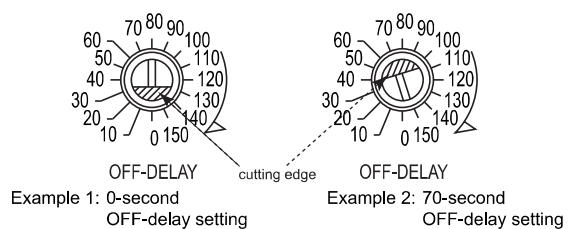

LED Indicators

Marking	Color	Name	G9SX-AD	G9SX-ADA	G9SX-BC	G9SX-EX	G9SX-EX-T	Function	Reference
PWR	Green	Power supply indicator	○	○	○	○	○	Lights up while power is supplied.	---
T1	Orange	Safety input 1 indicator	○	○	○	---	---	Lights up while a HIGH state signal is input to T12. Blinks when an error relating to safety input 1 occurs.	*
T2	Orange	Safety input 2 indicator	○	○	○	---	---	Lights up while a HIGH state signal is input to T22. Blinks when an error relating to safety input 2 occurs.	
FB	Orange	Feedback/reset input indicator	○	○	○	---	---	Lights up in the following cases: <ul style="list-style-type: none"> With automatic reset while a HIGH state signal is input to T33. With manual reset while a HIGH state signal is input to T32. Blinks when an error relating to feedback/reset input occurs.	
AND	Orange	Logical AND input indicator	○	---	---	---	---	Lights up while a HIGH state signal is input to T41. Blinks when an error relating to logical AND connection input occurs.	
AND1	Orange	Logical AND input indicator	---	○	---	---	---	Lights up while a HIGH state signal is input to T41. Blinks when an error relating to logical AND connection input occurs.	
AND2	Orange	Logical AND input indicator	---	○	---	---	---	Lights up while a HIGH state signal is input to T51. Blinks when an error relating to logical AND connection input occurs.	
EI	Orange	Safety output indicator	○	○	○	○	---	Lights up while the instantaneous safety outputs (S14, S24, S34) are in the ON-state. Blinks when an error relating to the instantaneous safety output occurs.	
ED	Orange	OFF-delayed safety output indicator	○	○	---	---	○	Lights up while OFF-delayed safety outputs (S44, S54) are in the ON-state. Blinks when an error relating to OFF-delayed safety output occurs.	
ERR	Red	Error indicator	○	○	○	○	○	Lights up or blinks when an error occurs.	

* Refer to *Fault Detection* on the next page for details.

Settings Indication (at Power ON)

Settings for the G9SX can be checked by the orange indicators for approx. 3 seconds after the power is turned ON. During this settings indication period, the ERR indicator will light, however the auxiliary error output will remain OFF









Indicator	Item	Setting position	Indicator status	Setting mode	Setting status
T1	Cross fault detection mode	Y1 terminal	Lit	Cross fault detection mode: ON	Y1 = open
			Not lit	Cross fault detection mode: OFF	Y1 = 24 VDC
FB	Reset mode	T32 or T33 terminal	Lit	Manual reset mode	T33 = 24 VDC
			Not lit	Auto reset mode	T32 = 24 VDC
AND (AND1, AND2)	Logical AND connection input mode	Logical AND connection preset switch	Lit	Enable logical AND input	"AND"
			Not lit	Disable logical AND input	"OFF"

Fault Detection





When the G9SX detects a fault, the ERR indicator and/or other indicators light up or blink to inform the user about the fault.

Check and take necessary measures referring to the following table, and then re-supply power to the G9SX.

(Advanced Unit/Basic Unit)

ERR indicator	Other indicator	Fault	Expected causes of the fault	Check points and measures to take	
 Blinks	---	Fault due to electro-magnetic disturbance or of internal circuits.	<ol style="list-style-type: none"> Excessive electro-magnetic disturbance Failure of the internal circuit 	<ol style="list-style-type: none"> Check the disturbance level around the G9SX and the related system. Replace with a new product. 	
 Lights up	 T1 blinks	Fault involved with safety input 1	<ol style="list-style-type: none"> Failure involving the wiring of safety input 1 Incorrect setting of cross fault detection input Failure of the circuit of safety input 1 	<ol style="list-style-type: none"> Check the wiring to T11 and T12. Check the wiring to Y1. Replace with a new product. 	
	 T2 blinks	Fault involved with safety input 2	<ol style="list-style-type: none"> Failure involving the wiring of safety input 2 Incorrect setting of cross fault detection input Failure of circuits of safety input 2 	<ol style="list-style-type: none"> Check the wiring to T21 and T22. Check the wiring to Y1. Replace with a new product. 	
	 FB blinks	Fault in Expansion Unit	Faults involved with feedback/reset input	<ol style="list-style-type: none"> Failures involving the wiring of feedback/reset input. Failures of the circuit of feedback/reset input 	<ol style="list-style-type: none"> Check the wiring to T31, T32 and T33. Replace with a new product.
			<ol style="list-style-type: none"> Improper feedback signals from Expansion Unit Abnormal supply voltage to Expansion Unit Failure of the circuit of safety relay contact outputs 	<ol style="list-style-type: none"> Check the connecting cable of Expansion Unit and the connection of the termination socket. Check the supply voltage to Expansion Unit. Note: Make sure that all Expansion units' PWR indicators are lit. Replace the Expansion Unit with a new one. 	
	 EI blinks	Fault involved with instantaneous safety outputs or logical AND connection outputs or auxiliary monitor output	<ol style="list-style-type: none"> Failure involving the wiring of instantaneous safety outputs Failure of the circuit of Instantaneous safety outputs Failure involving the wiring of the logical AND connection output Failure of the circuit of the logical AND connection output Failure involving the wiring of the auxiliary monitor output Impermissible high ambient temperature 	<ol style="list-style-type: none"> Check the wiring to S14, S24, and S34. Replace with a new product. Check the wiring to L1 and L2. Replace with a new product. Check the wiring to X1. Check the ambient temperature and spacing around the G9SX. 	
	 ED blinks	Fault involved with OFF-delayed safety outputs	<ol style="list-style-type: none"> Failure involving the wiring of OFF-delayed safety relay contact outputs Incorrect set values for OFF-delay time Failure of the circuit of OFF-delayed safety relay contact outputs Impermissible high ambient temperature 	<ol style="list-style-type: none"> Check the wiring to S44 and S54. Confirm the set values of the two OFF-delay time preset switches. Replace with a new product. Check the ambient temperature and spacing around the G9SX. 	
	 AND blinks (AND1, AND2)	Fault involved with logical AND connection input	<ol style="list-style-type: none"> Failure involving the wiring of the logical AND connection input Incorrect setting for the logical AND connection input Failure of the circuit of the logical AND connection input 	<ol style="list-style-type: none"> Check the wiring to T41 and T42 (T51 and T52). Note: Make sure that the wiring length for the T41, T42, T51, T52 terminal is less than 100 meters. Make sure that the logical AND connection signal is branched for less than 4 units. Confirm the set value of the logical AND connection preset switch. Replace with a new product. 	
 All indicators except PWR blink	Supply voltage outside the rated value	<ol style="list-style-type: none"> Supply voltage outside the rated value 	<ol style="list-style-type: none"> Check the supply voltage to the Units. 		

When indicators other than the ERR indicator blink, check and take necessary actions referring to the following table.

ERR indicator	Other indicators	Fault	Expected cause of the fault	Check points and measures to take			
 Off	<table border="1"> <tr> <td>T1</td> <td rowspan="2"> Blink</td> </tr> <tr> <td>T2</td> </tr> </table>	T1	 Blink	T2	Mismatch between input 1 and input 2.	The input status between input 1 and input 2 is different, due to contact failure or a short circuit of safety input device(s) or a wiring fault.	Check the wiring from safety input devices to the G9SX. Or check the input sequence of safety input devices. After removing the fault, turn both safety inputs to the OFF state.
T1	 Blink						
T2							

(Expansion Unit)

ERR indicator	Other indicators	Fault	Expected cause of the faults	Check points and measures to take
 Lights	---	Fault involved with safety relay outputs of Expansion Units	<ol style="list-style-type: none"> Welding of relay contacts Failure of the internal circuit 	Replace with a new product.

Dimensions and Terminal Arrangement

(Unit: mm)

Advanced Unit

G9SX-AD322-□

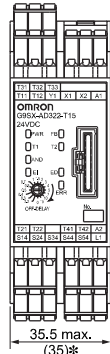
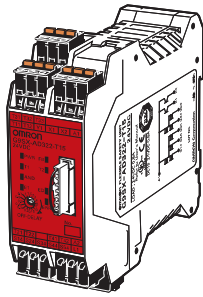

* Typical dimension

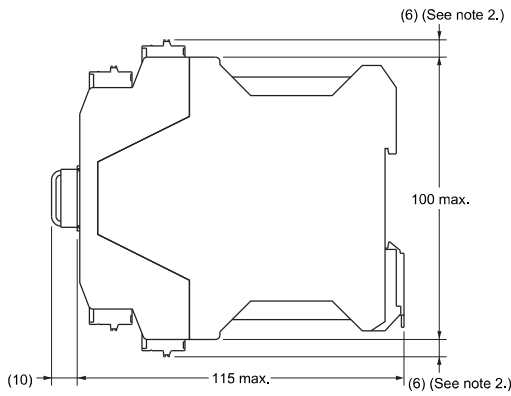

Note: 1. Above outline drawing is for -RC terminal type.
2. For -RC terminal type only.

Terminal arrangement

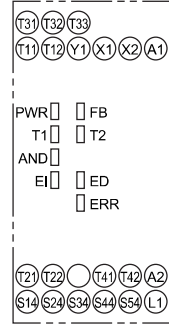

Advanced Unit

G9SX-ADA222-□

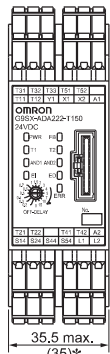
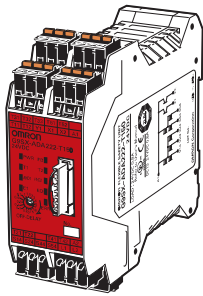

* Typical dimension

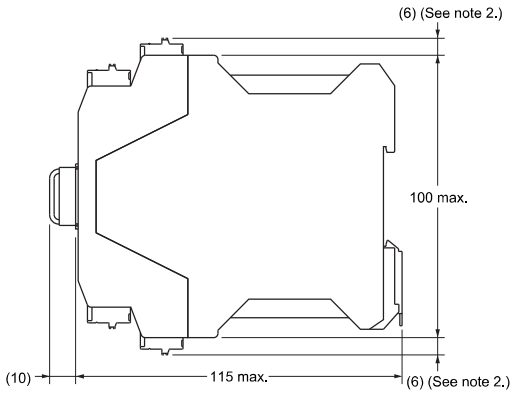

Note: 1. Above outline drawing is for -RC terminal type.
2. For -RC terminal type only.

Terminal arrangement

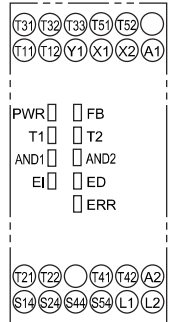

Basic Unit

G9SX-BC202-□

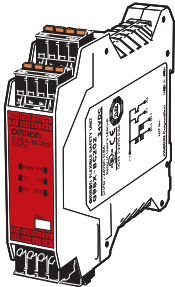

* Typical dimension

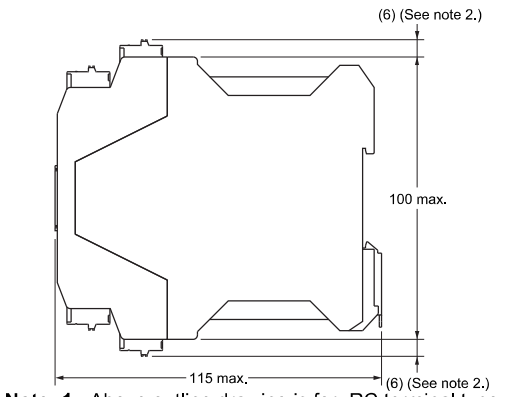

Note: 1. Above outline drawing is for -RC terminal type.
2. For -RC terminal type only.

Terminal arrangement

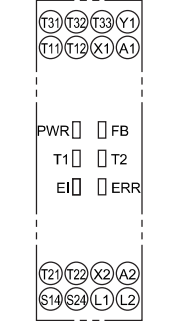

Expansion Unit

G9SX-EX401-□

Expansion Unit (OFF-delayed Model)

G9SX-EX041-T-□

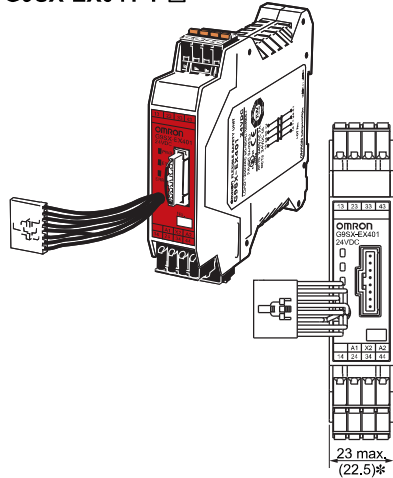

* Typical dimension

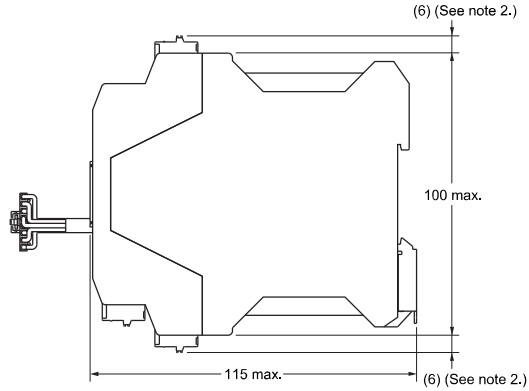

Note: 1. Above outline drawing is for -RC terminal type.
2. For -RC terminal type only.

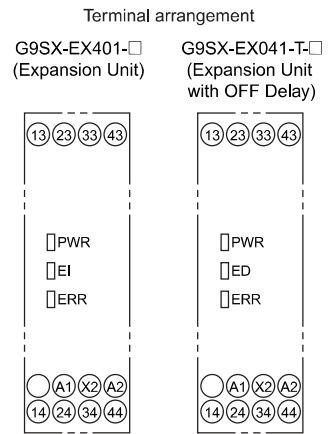

Application Examples

PL/safety category	Model	Stop category	Reset
PLc/2 equivalent	Emergency Stop Switch A165E/A22E Flexible Safety Unit G9SX-AD322-T15	M1: 0 M2: 1	Manual

Note: The above PL is only the evaluation result of the example. The PL must be evaluated in an actual application by the customer after confirming the usage conditions.

● Application Overview

- The power supply to the motor M1 is turned OFF immediately when the emergency stop switch is pressed, and stop command is sent to the motor controller for the motor M2.
- The power supply to the motor M2 is turned OFF after OFF-delay time.
- The power supply to the motor M1 and M2 is kept OFF until the reset switch S2 is pressed while the emergency stop switch is released.

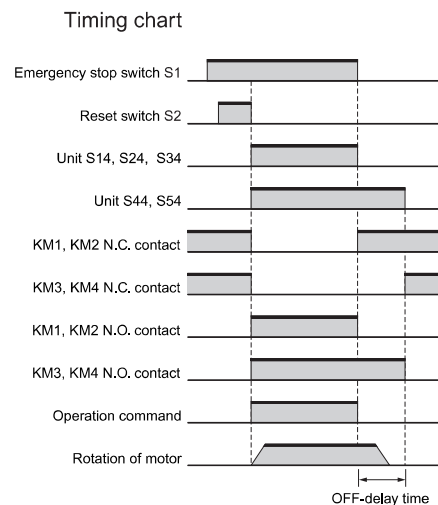
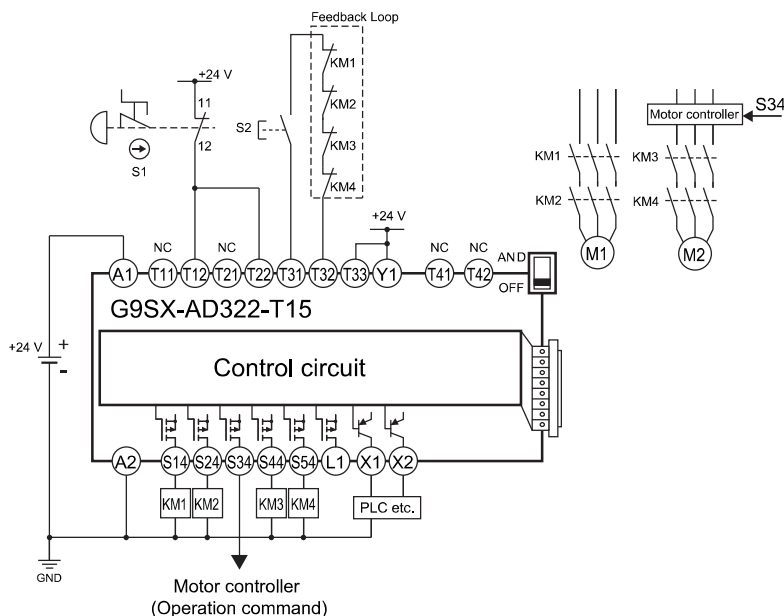

- S1: Emergency Stop Switch
- S2: Reset Switch S2
- KM1 to KM4: Contactor
- M1, M2: 3-phase motor

PL/safety category	Model	Stop category	Reset
PL _e /4 equivalent	Safety Light Curtain F3SJ-A□□□□P□□□ Flexible Safety Unit G9SX-AD322-T15	M1: 0 M2: 1	Auto

Note: The above PL is only the evaluation result of the example. The PL must be evaluated in an actual application by the customer after confirming the usage conditions.

● **Application Overview**

- The power supply to the motor M1 is turned OFF immediately when the beam is blocked, and stop command is sent to the motor controller for the motor M2.
- The power supply to the motor M2 is turned OFF after OFF-delay time.
- The power supply to the motor M1 and M2 is kept OFF until the beam is unblocked.

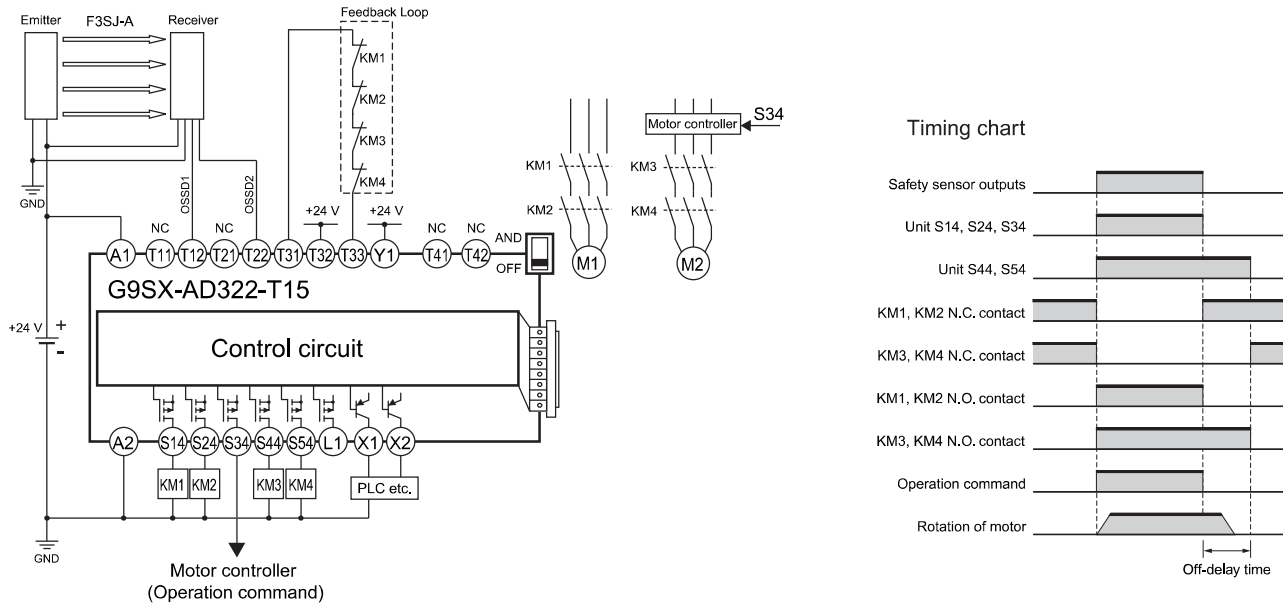

- F3SJ-A: Safety sensor
- KM1 to KM4: Contactor
- M1, M2: 3-phase motor

- Note:**
1. For further information of settings and wiring, refer to the catalog or instruction manual of the connected sensor.
 2. Use safety sensors with PNP outputs.

PL/safety category	Model	Stop category	Reset
PLe/4 equivalent	Emergency Stop Switch A165E/A22 Flexible Safety Unit G9SX-BC202 Safety Limit Switch D4B-N/D4N/D4F Flexible Safety Unit G9SX-AD322-T15	M1, M2: 0 M3: 1	Emergency Stop: Manual Guard: Auto

Note: The above PL is only the evaluation result of the example. The PL must be evaluated in an actual application by the customer after confirming the usage conditions.

● **Application Overview**

- When the emergency stop switch S1 is pressed.
 - The power supply to the motor M1 and M2 is turned OFF immediately when the emergency stop switch S1 is pressed. Stop command is sent to the motor controller for the motor M3, and the power supply to the motor M3 is turned OFF after OFF-delay time.
 - The power supply to the motor M1 is kept OFF until the emergency stop switch S1 is released and the reset switch S2 is pressed.
 - The power supply to the motor M2 and M3 is kept OFF until the guard is closed and the reset switch S2 is pressed while the emergency stop switch S1 is released.
- When the guard is opened (the emergency stop switch S1 is released).
 - The power supply to the motor M2 is turned OFF immediately when the S3 and S4 detect that the guard is opened. Stop command is sent to the motor controller for the motor M3, and the power supply to the motor M3 is turned OFF after OFF-delay time. (The power supply to the motor M1 is kept ON.)
 - The power supply to the motor M2 and M3 is kept OFF until the guard is closed.

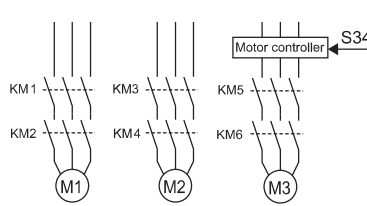
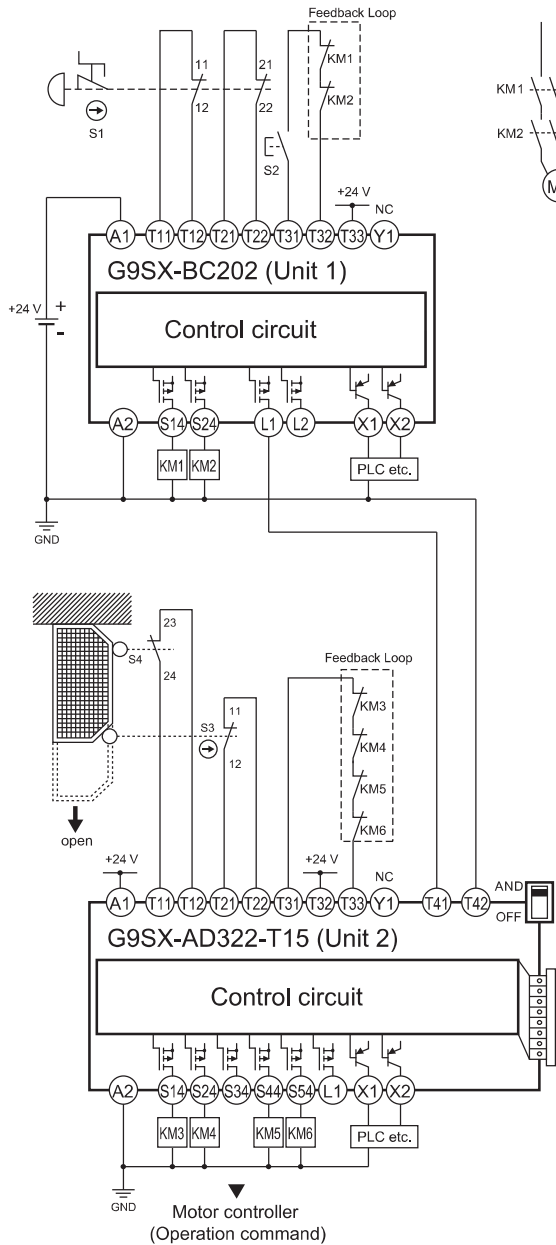

S1: Emergency Stop Switch
 S2: Reset Switch
 S3: Safety Limit Switch
 S4: Limit Switch
 KM1 to KM6: Contactor
 M1 to M3: 3-phase motor

Timing chart

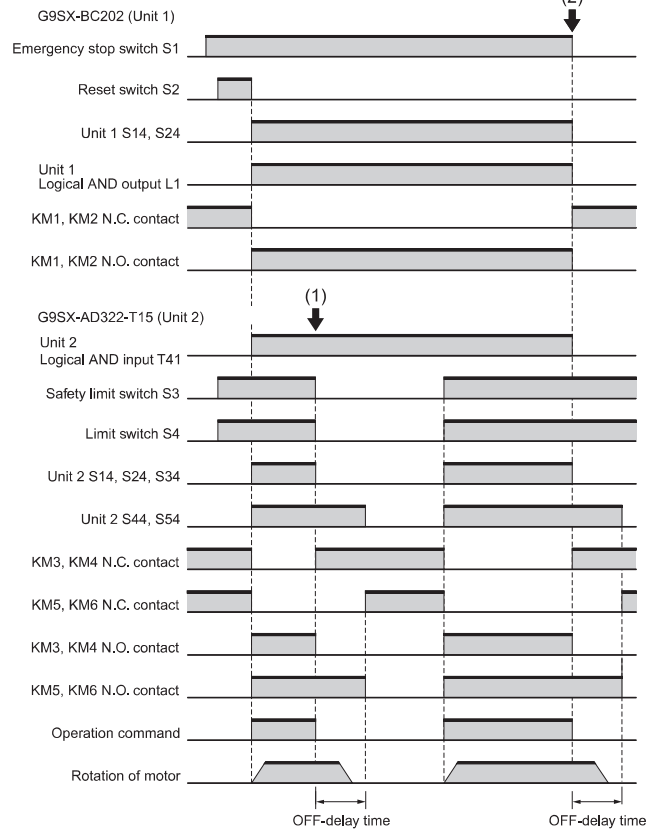

(1) Guard opened: Only the Unit 2 stops.
 (2) Emergency stop switch pressed: Both the Unit 1 and 2 stop.

PL/safety category	Model	Stop category	Reset
PLe/4 equivalent	Guard Lock Safety-door Switch D4NL Safety Limit Switch D4B-N/D4N/D4F Flexible Safety Unit G9SX-AD322-T15 + G9SX-EX041-T	M1: 0 M2, M3: 1	Manual

Note: The above PL is only the evaluation result of the example. The PL must be evaluated in an actual application by the customer after confirming the usage conditions.

● **Application Overview**

- The power supply to the motor M1 is turned OFF immediately when the stop signal is input, and stop command is sent to the motor controller to decelerate the motor M2.
- The power supply to the motor M2 and M3 is turned OFF after OFF-delay time.
- When all the NC contacts of the KM1 to KM6 are closed and the lock release signal is input, the guard can be opened only while the lock release switch S4 is pressed.
- The power supply to the motor M1 to M3 is kept OFF until the reset switch S3 is pressed while the guard is closed and the lock release switch S4 is released.

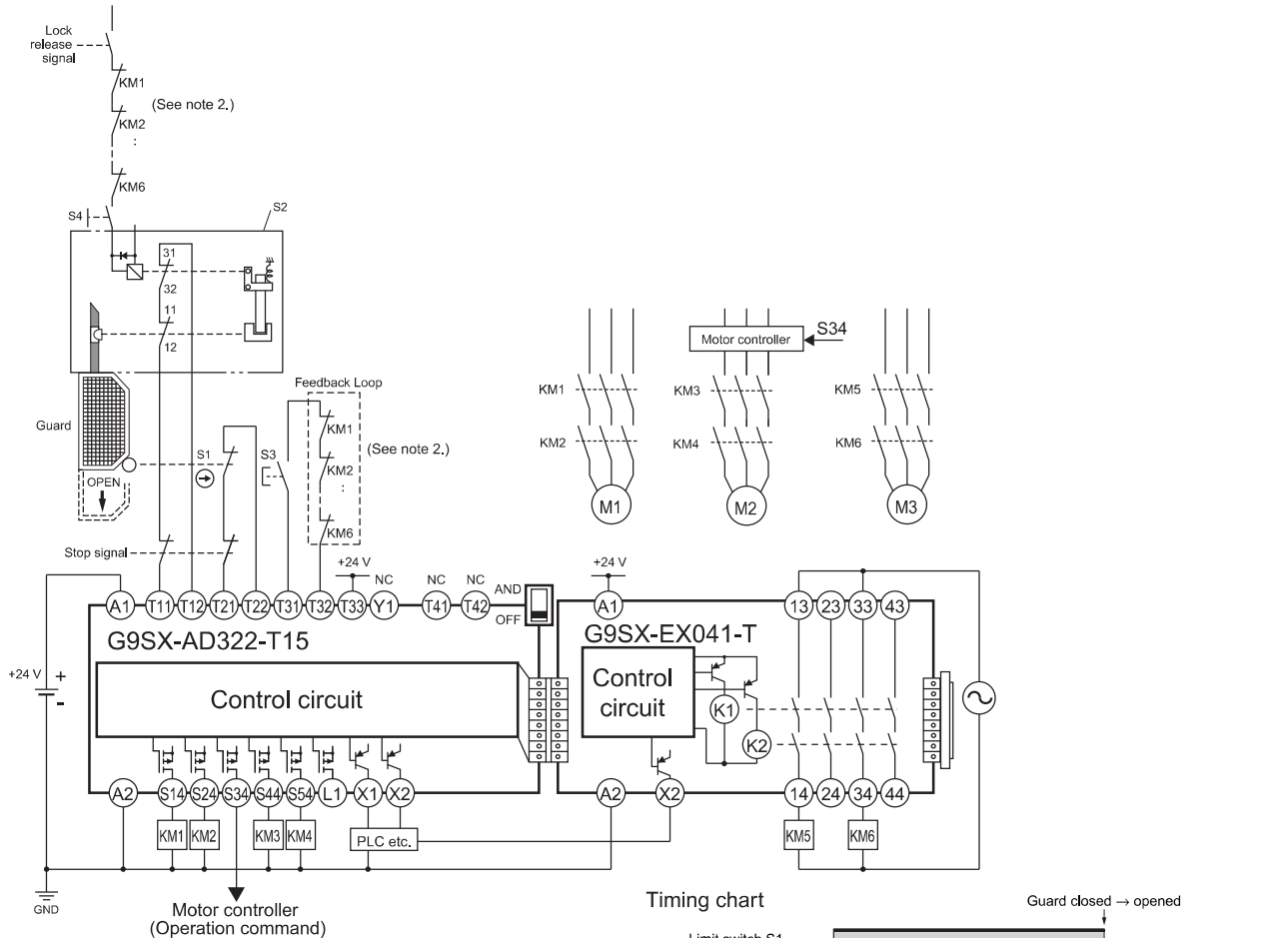

- S1: Safety limit switch
- S2: Guard lock safety door switch (Mechanical Lock)
- S3: Reset switch
- S4: Lock release switch
- KM1 to KM6: Contactor
- M1 to M3: 3-phase motor

Note: Connect the N.C. contacts of contactors KM1, KM2, KM3, KM4, KM5, and KM6 in series.

PL/safety category	Model	Stop category	Reset
PL _e /4 equivalent	Emergency Stop Switch A165E/A22E Flexible Safety Unit G9SX-BC202 Safety Limit Switch D4B-N/D4N/D4F Flexible Safety Unit G9SX-AD322-T15 Flexible Safety Unit G9SX-ADA222-T150	M1, M2, M3: 0 M4: 1	Emergency Stop : Manual Guard 1, 2, 3: Auto

Note: The above PL is only the evaluation result of the example. The PL must be evaluated in an actual application by the customer after confirming the usage conditions.

● Application Overview

1. When the emergency stop switch S1 is pressed.
 - The power supply to the motor M1 to M3 is turned OFF immediately when the emergency stop switch S1 is pressed. Stop command is sent to the motor controller for the motor M4, and the power supply to the motor M4 is turned OFF after OFF-delay time.
 - The power supply to the motor M1 is kept OFF until the reset switch S2 is pressed while the emergency stop switch S1 is released.
 - The power supply to the motor M2 is kept OFF until the guard 1 is closed and the reset switch S2 is pressed while the emergency stop switch S1 is released.
 - The power supply to the motor M3 is kept OFF until the guard 2 is closed and the reset switch S2 is pressed while the emergency stop switch S1 is released.
 - The power supply to the motor M4 is kept OFF until the guard 1 to 3 are closed and the reset switch S2 is pressed while the emergency stop switch S1 is released.
2. When the guard 1 is opened (the emergency stop switch S1 is released).
 - The power supply to the motor M2 is turned OFF immediately when the S3 and S4 detect that the guard 1 is opened. Stop command is sent to the motor controller for the motor M4, and the power supply to the motor M4 is turned OFF after OFF-delay time.
 - The power supply to the motor M2 is kept OFF until the guard 1 is closed.
 - The power supply to the motor M4 is kept OFF until the guard 1 to 3 are closed.
3. When the guard 2 is opened (the emergency stop switch S1 is released).
 - The power supply to the motor M3 is turned OFF immediately when the S5 and S6 detect that the guard 2 is opened. Stop command is sent to the motor controller for the motor M4, and the power supply to the motor M4 is turned OFF after OFF-delay time.
 - The power supply to the motor M3 is kept OFF until the guard 2 is closed.
 - The power supply to the motor M4 is kept OFF until the guard 1 to 3 are closed.
4. When the guard 3 is opened (the emergency stop switch S1 is released).
 - When the S7 and S8 detect that the guard 3 is opened, stop command is sent to the motor controller for the motor M4 and the power supply to the motor M4 is turned OFF after OFF-delay time.
 - The power supply to the motor M4 is kept OFF until the guard 1 to 3 are closed.

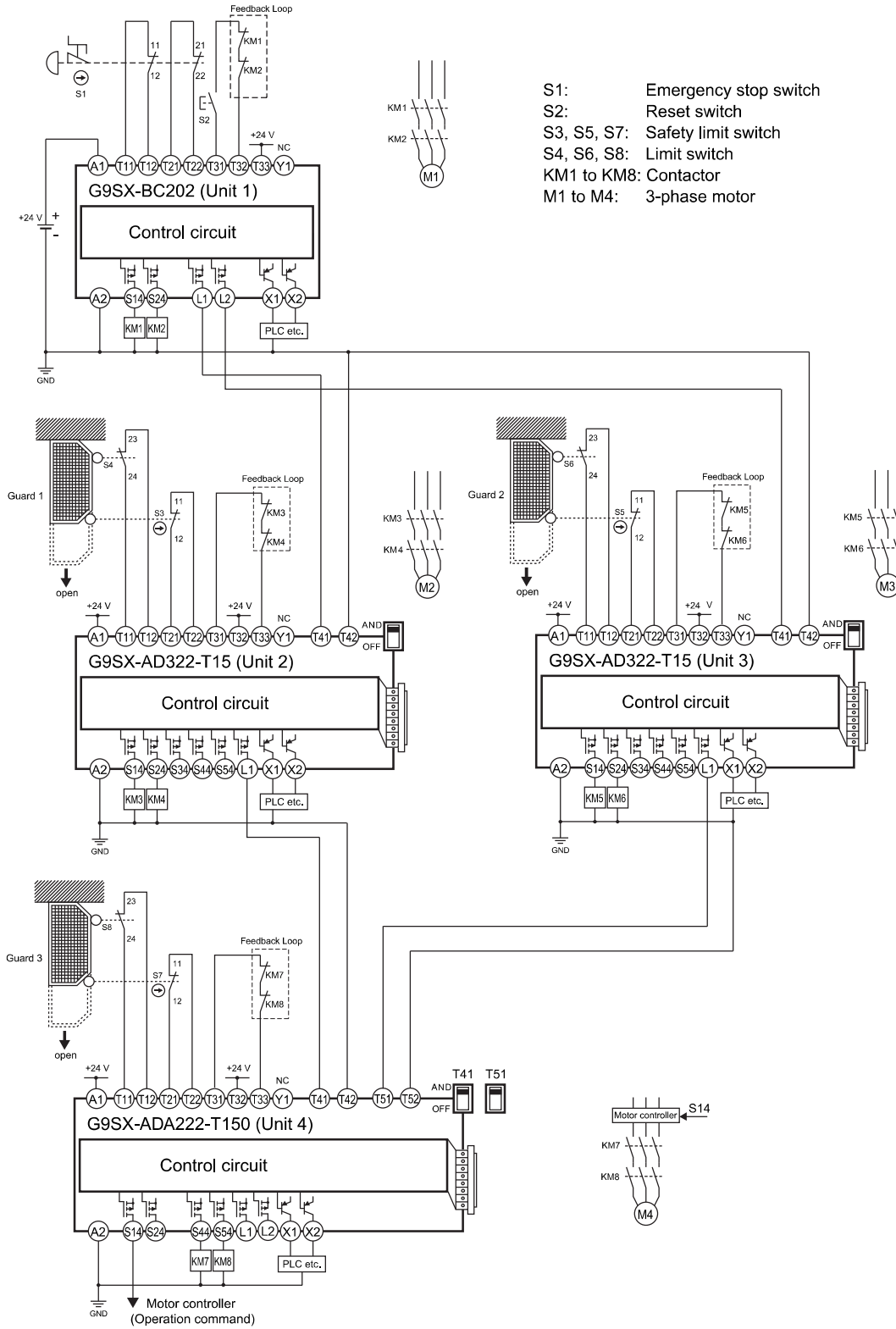

Timing chart

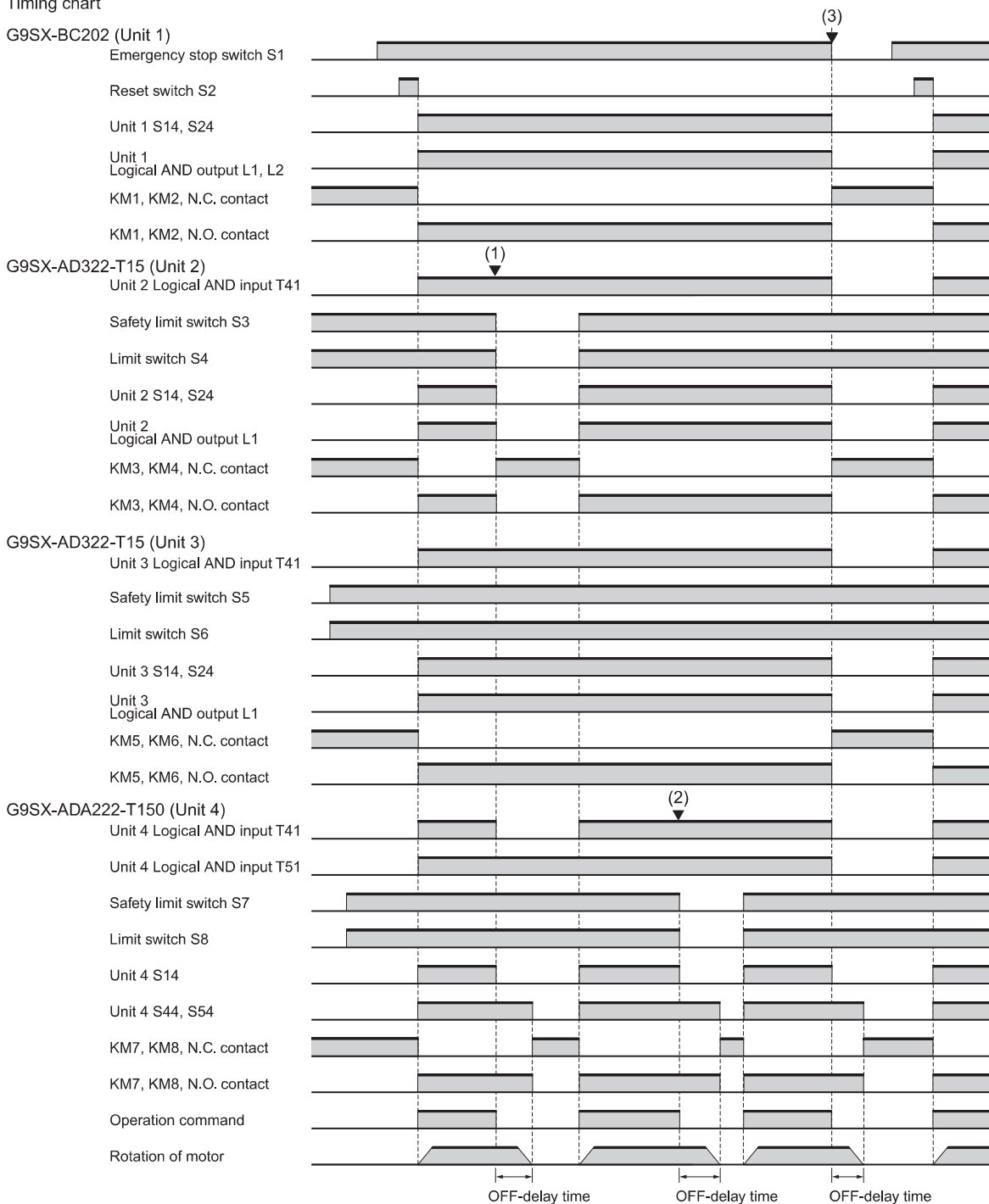

- (1) Guard 1 opened: Unit 2 and Unit 4 stop.
- (2) Guard 3 opened: Unit 4 stops.
- (3) Emergency stop switch pressed: All units stop.

Safety Precautions

Refer to “Precautions for All Relays” and Precautions for “Precautions for All Relays with Forcibly Guided Contacts” for more detailed information.

Indication and Meaning for Safe Use

WARNING	Indicates a potentially hazardous situation which, if not avoided, will result in minor or moderate injury, or may result in serious injury or death. Additionally there may be significant property damage.
Precautions for Safe Use	Supplementary comments on what to do or avoid doing, to use the product safely.
Precautions for Correct Use	Supplementary comments on what to do or avoid doing, to prevent failure to operate, or undesirable effect on product performance.

WARNING

<Precautions for All G9SX Models>

Serious injury may possibly occur due to breakdown of safety outputs. Do not connect loads beyond the rated value to the safety outputs.

Serious injury may possibly occur due to loss of required safety functions. Wire the G9SX properly so that the safety outputs do not short-circuit with the Unit power supply or load power supply.

Serious injury may possibly occur due to malfunction of safety outputs. Add a circuit to protect against back electromotive force when connecting inductive loads to safety outputs.

Serious injury may possibly occur due to loss of safety functions. Use appropriate devices as given in the following table.

Control Devices	Requirements
Door interlocking switches or Safety limit switches	Use approved devices with Direct Opening Mechanism complying with IEC/EN 60947-5-1 and capable of switching micro loads of 24 VDC, 5 mA.
Safety sensors	Use approved devices complying with the relevant product standards, regulations and rules in the country where it is used. Consult a certification body to assess that the entire system satisfies the required safety category level.
Relays with forcibly guided contacts	Use approved devices with forcibly guided contacts complying with EN 50205. For feedback purpose use devices with contacts capable of switching micro loads of 24 VDC, 5 mA.
Contactors	Use contactors with forcibly guided mechanism to input the signal to Feedback/Reset input of G9SX through the NC contact of the contactor. For feedback purpose use devices with contacts capable of switching micro loads of 24 VDC, 5 mA. Failure to open contacts of a contactor cannot be detected by monitoring its auxiliary NC contact without forcibly guided mechanism.
Emergency stop switches	Use approved devices with Direct Opening Mechanism complying with IEC/EN 60947-5-1 Do not connect an emergency stop switch to the G9SX-GS□.
Other devices	Evaluate whether devices used are appropriate to satisfy the requirements of safety category level.

<G9SX-GS□>

Serious injury may possibly occur due to loss of safety functions. Construct an appropriate safety system as shown in the following table.

Switching function	Auto switching
Safety system configuration example	
Safety precautions	<ol style="list-style-type: none"> Select Safety Sensors that satisfy the following condition: Diameter of the smallest detectable object < Diameter of the object to be detected Install the Safety Sensors so that they satisfy the following conditions: (1) Use Safety Sensor A to detect the entry of the machine into area A, and Safety Sensor B to detect the entry of a person into area A. (2) Make sure that the machine can reach area A only by passing through Safety Sensor A, and that a person can reach area A only by passing through Safety Sensor B. Provide a protective structure to prevent a person from passing completely through Safety Sensor B and stepping into area A. If this is not possible, install a sensor that will detect the presence of a person inside area A and prevent the machine from being restarted while the person is inside area A. Provide a sufficient safety distance (S1) considering the entry speed of a person and a sufficient safety distance (S2) considering the entry speed of the machine. For details, refer to “Safety Distance” on page 48.
Switching function	Manual switching
Safety system configuration example	
Safety precautions	<ol style="list-style-type: none"> Select Safety Sensors that satisfy the following condition: Diameter of the smallest detectable object < Diameter of the object to be detected Install the Safety Sensors so that they satisfy the following conditions: (1) Use the Safety Sensor to detect the entry of the machine into area A. (2) Make sure that the machine can reach area A only by passing through the Safety Sensor. Provide a protective structure to prevent a person from stepping into area A when the door is opened. If this is not possible, install a sensor that will detect the presence of a person inside area A and prevent the machine from being restarted while the person is inside area A. Provide a sufficient safety distance (S2) considering the entry speed of the machine. For details, refer to “Safety Distance” on page 48. Position the mode selector in a location where it cannot be operated from inside area A.

Safety Distance

The safety distance is the minimum distance that must be provided between the safety input device and a machine's hazardous part to stop the hazardous part before a person or object reaches it. The safety distance varies according to the standards of each country and the specifications of each machine. In addition, the calculation of the safety distance differs if the direction of approach is not perpendicular to the detection zone of the safety input device. Always refer to the relevant standards.

Safety Distance Concepts

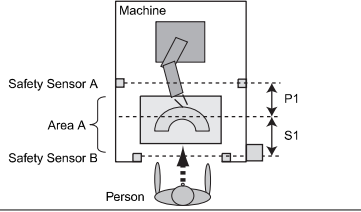
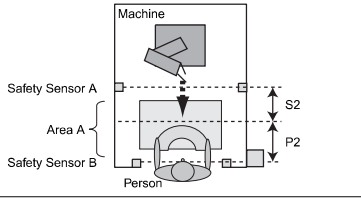
<p>When a person approaches a hazard (machine)</p>	 <ul style="list-style-type: none"> • S1: Safety distance 1 • P1: The closest that a machine can come to a person while operating (the boundary of the machine's operating area)
<p>When a hazard (machine) approaches a person</p>	 <ul style="list-style-type: none"> • S2: Safety distance 2 • P2: The closest that a part of a person can come to a machine.

Safety Distance Calculation Examples (Reference)

<p>Calculating the safety distance specified by international standard ISO 13855-2002 (European standard EN 999-1999)</p>	<p>If a person approaches the detection zone perpendicularly, calculate the safety distance as shown below.</p> $S1 = K1 \times T + C$ $S2 = K2 \times T + C$ <p>S1: Safety distance 1 S2: Safety distance 2 K1: Approach speed of a person to the detection zone (area A) K2: Maximum approach speed of a machine to the detection zone (area A) T: Total response time of the machine and G9SX system C: Additional distance calculated by the detection capability (the diameter of the smallest detectable object) of the Safety Sensor.</p>
<p>Calculating the safety distance specified by American standard ANSI B11.19</p>	<p>If a person approaches the detection zone perpendicularly, calculate the safety distance as shown below.</p> $S1 = K1 \times (Ts + Tc + Tr + Tbm) + Dpf$ $S2 = K2 \times (Ts + Tc + Tr + Tbm) + Dpf$ <p>S1: Safety distance 1 S2: Safety distance 2 K1: Approach speed of a person to the detection zone (area A) K2: Maximum approach speed of a machine to the detection zone (area A) Ts: Machine's stop time (s) Tr: Response time of the G9SX system from ON to OFF (s) Tc: Machine control circuit's maximum response time required to activate its brake (s) Tbm: Additional time (s) Dpf: Additional distance</p>

1. To determine the approach speed K1, consider all factors, including the operator's physical abilities.
2. To determine the maximum approach speed K2, consult with a notified body or other authoritative institutes.
3. The response time of a machine is the time from when the machine receives a stop signal to the time when the machine's hazardous part stops. Measure the response time on the actual system. Also, periodically check that the machine's response time has not changed.
4. For information on the response time of the G9SX system, refer to item 10 of "Precautions for Correct Use" on page 49.

Precautions for Safe Use

<Precautions for All G9SX Models>

1. Use G9SX within an enclosure with IP54 protection or higher of IEC60529.
2. Incorrect wiring may lead to loss of safety function. Wire conductors correctly and verify the operation of G9SX before commissioning the system in which G9SX is incorporated.
3. Do not apply DC voltages exceeding the rated voltages, or any AC voltages to the G9SX power supply input.
4. Use DC supply satisfying requirements below to prevent electric shock.
 - DC power supply with double or reinforced insulation, for example, according to IEC/EN60950 or EN50178 or a transformer according to IEC/EN61558.
 - DC supply satisfies the requirement for class 2 circuits or limited voltage/current circuit stated in UL 508.
5. Apply properly specified voltages to G9SX inputs. Applying inappropriate voltages cause G9SX to fail to perform its specified function, which leads to the loss of safety functions, damages to G9SX, or burning.
6. Auxiliary error outputs and auxiliary monitoring outputs are NOT safety outputs. Do not use auxiliary outputs as any safety output. Such incorrect use causes loss of safety function of G9SX and its relevant system. Also Logical AND connection outputs can only be used for logical AND connections between G9SXs.
7. After installation of G9SX, qualified personnel should confirm the installation, and should conduct test operations and maintenance. The qualified personnel should be qualified and authorized to secure the safety on each phases of design, installation, running, maintenance and disposal of system.
8. A person in charge, who is familiar to the machine in which G9SX is to be installed, should conduct and verify the installation.
9. Inspect the G9SX daily and every six months. Incorrect system operation may result in serious injury.
10. Do not dismantle, repair, or modify G9SX. It may lead to loss of its safety functions, creating a dangerous situation.
11. Use only appropriate components or devices complying with relevant safety standards corresponding to the required level of safety categories. Conformity to requirements of safety category is determined as an entire system. It is recommended to consult a certification body regarding assessment of conformity to the required safety level.
12. OMRON shall not be responsible for conformity with any safety standards regarding to customer's entire system.
13. Disconnect G9SX from power supply when wiring, to prevent electric shock or unexpected operation.
14. Be cautious not to have your fingers caught when attaching terminal sockets to the plugs on G9SX.
15. Do not use in combustible gases or explosive gases.

<G9SX-GS□>

1. Be sure to correctly connect safety input devices to safety input A and safety input B to ensure proper operation of the safety functions.
2. When setting the Switching Function, be sure to consider safety control requirements, safety level and safety category of the entire system.
3. A qualified personnel who has a thorough understanding of the installed machine must switch the mode selector input. For example, a Switching Unit with Key must be used for the mode selector, and the key must be managed and used in such a way that the machine cannot be operated by unauthorized persons.

<G9SX-EX□>

1. The durability of relays depend greatly on the switching condition. Confirm the actual conditions of operation in which the relay will be used in order to make sure of the permissible number of switching operations.

Precautions for Correct Use**<Precautions for All G9SX Models>**

1. Handle with care
Do not drop G9SX to the ground or expose to excessive vibration or mechanical shocks. G9SX may be damaged and may not function properly.
2. Conditions of storage
G9SX may be damaged and may not function properly. Do not store in such conditions stated below.
 1. In direct sunlight
 2. At ambient temperatures out of the range of -10 to 55°C .
 3. At relative humidity out of the range of 25% to 85% or under such temperature change that causes condensation.
 4. In corrosive or combustible gases
 5. With vibration or mechanical shocks out of the rated values.
 6. Under splashing of water, oil, chemicals
 7. In the atmosphere containing dust, saline or metal powder.
3. Mounting
Mount G9SX to DIN track with attachments (PFP-M, not incorporated to this product), not to drop off the track by vibration or other force especially when the length of DIN track is short compared to the widths of G9SX.
4. Following spacing around G9SX should be available to apply rated current to outputs of G9SX and for enough ventilation and wiring:
 1. At least 25 mm beside side faces of the G9SX.
 2. At least 50 mm above top face of G9SX and below bottom face of G9SX.

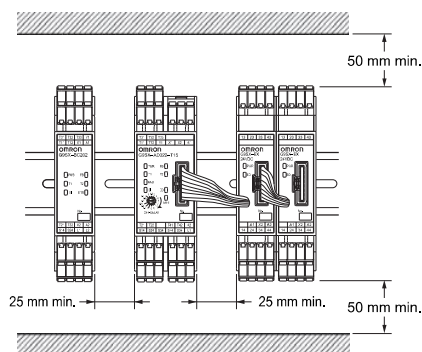
**5. Wiring****(1) G9SX**

- Wire the G9SX as described below.

Solid wire	0.2 to 2.5 mm ² (AWG24 to AWG12)
Stranded wire	0.2 to 2.5 mm ² (AWG24 to AWG12)

- Strip no more than 7 mm of insulation from the end of the wire.

(2) G9SX-□-RT (with Screw Terminals)

- Tighten each screw to 0.5 to 0.6 N·m or the G9SX-□-RT may malfunction or generate heat.

(3) Wiring for a Logical AND Connection

- Use a 2-conductor cable or shielded cable to wire a logical AND connection between Units.

6. Connecting Expansion Units (G9SX-EX□-□):**(Only G9SX-AD□/-ADA□/-NSA□/-GS□)****(1)** Remove the termination connector from the G9SX, and insert the connector of the Expansion Unit into the G9SX to connect it.**(2)** Insert the termination connector into the last Expansion Unit as viewed from the G9SX. When the G9SX is used without any Expansion Units, do not remove the termination connector from the G9SX.**(3)** Do not remove the termination connector while the system is operating.**(4)** Before applying the power supply voltage, confirm that the connecting sockets and plugs are locked.**(5)** Make sure that all connected Expansion Units are supplied with power within 10 s after the power to the G9SX is turned ON. Otherwise, the G9SX will detect a power supply error for the Expansion Units.**7.** Use cables with a length of 100 m maximum to connect the safety inputs, feedback/reset input, logical AND connection input, logical AND connection output, or mode selector inputs.**8.** Set the time duration of OFF-delay to an appropriate value that does not cause the loss of safety function of system.**9. Logical AND connection between Units**

1. When using Logical AND connection inputs, set the Logical AND connection preset switch to 'AND' position for the units which the logical AND connection signal are input to.

2. Connect Logical AND connection outputs appropriately to Logical AND connection inputs of the relevant unit. Verify the operation of G9SX before commissioning the system.

3. Give careful consideration to the response time delay during logical AND connection in order to prevent any reduction in the safety of the safety control system.

4. Use two-conductor cable or shielded cable for wiring the logical AND connections between Units.

10. To determine the safety distance to hazards, take into account the delay of safety outputs caused by the following times:**(1)** Response time of safety inputs**(2)** Response time of logical AND connection input
(Also consider the precaution in " * " below)**(3)** Preset OFF-delay time**(4)** Accuracy of OFF-delay time

* When connecting multiple Units with logical AND connections, the operating time and response time after logical AND connection inputs will be the sum of the operating times and response times of the Units that are connected in series by logical AND connections.

11. Start entire system after more than 5 s have passed since applying supply voltage to all G9SXs in the system.
12. Power Supply
 - (1) The G9SX may malfunction due to electromagnetic disturbances. Be sure to connect terminal A2 to ground.
 - (2) When sharing a power supply with a Safety Light Curtain, use a power supply that will not fail for a momentary power interruption of 20 ms or less.
13. Devices connected to G9SX may operate unexpectedly. When replacing G9SX, disconnect it from power supply.
14. Adhesion of solvent such as alcohol, thinner, trichloroethane or gasoline on the product should be avoided. Such solvents make the marking on G9SX illegible and cause deterioration of parts.
15. Do NOT mix AC load and DC load to be switched in one G9SX-EX□-□. When switching of both AC load and DC load is necessary, connect more than two G9SX-EX□-□ and use each unit for AC load and DC load exclusively.

<G9SX-GS>

1. Use a mode selector that has an SPST-NO + SPST-NC contact form (e.g., OMRON's A22K-□-11).

Safety Category (EN ISO 13849-1)

In the condition shown in *Application Examples*, G9SX can be used for the corresponding categories up to Safety category 4 per EN ISO13849-1.

This does NOT mean that G9SX can always be used for required category under all the similar conditions and situations. Conformity to the categories must be assessed as a whole system. When using G9SX for safety categories, be sure to confirm the conformity as a whole system.

Applicable Safety Category 4 (EN ISO13849-1)

1. Input signals to both safety inputs (T11-T12, T21-T22, T61-T62, and T71-T72).
2. Input signals to the safety inputs (T11-T12, T21-T22, T61-T62, and T71-T72) through switches equipped with a direct opening mechanism.
When using limit switches, at least one of them must have a direct opening mechanism.
3. When connecting a Safety Sensor to the G9SX, use a TYPE 4 Safety Sensor.
4. Input the signal through a NC contact of the contactor to Feedback/Reset input (T31-T32 for manual reset or T31-T33 for auto reset).
5. Keep the cross fault detection mode input (Y1 and Y2) open. However, when connecting devices that have a self-diagnosis function, such as Safety Sensors, apply 24 VDC to Y1 or Y2.
6. Be sure to connect A2 to ground.
7. When using a G9SX-EX□-□ Expansion Unit, connect fuses with a current rating of 3.15 A maximum to the safety relay outputs to prevent the contacts from welding.

Compliance with International Standards

Item	Model	G9SX-AD G9SX-ADA	G9SX-BC	G9SX-GS	G9SX-EX
Approved by TÜV SÜD	EN60204-1	Approved	Approved	Approved	Approved
	EN ISO13849-1 PLe/Safety Category 4	Approved	Approved	Approved	Approved
	EN61508 SIL3	Approved	Approved	Approved	Approved
	EN62061 SIL3	Not approved	Not approved	Approved	Not approved
	IEC/EN60947-5-2	Not approved	Not approved	Not approved	Not approved
Approved by UL	IEC/EN60947-5-3 PDF-M	Not approved	Not approved	Not approved	Not approved
	UL508	Approved	Approved	Approved	Approved
	UL1998	Approved	Approved	Approved	Approved
Approved by KOSHA	CAN/CSA C22.2 No.142	Approved	Approved	Approved	Approved
		Approved	Approved	Approved	Approved

Terms and Conditions of Sale

1. **Offer; Acceptance.** These terms and conditions (these "Terms") are deemed part of all quotes, agreements, purchase orders, acknowledgments, price lists, catalogs, manuals, brochures and other documents, whether electronic or in writing, relating to the sale of products or services (collectively, the "Products") by Omron Electronics LLC and its subsidiary companies ("Omron"). Omron objects to any terms or conditions proposed in Buyer's purchase order or other documents which are inconsistent with, or in addition to, these Terms.
2. **Prices; Payment Terms.** All prices stated are current, subject to change without notice by Omron. Omron reserves the right to increase or decrease prices on any unshipped portions of outstanding orders. Payments for Products are due net 30 days unless otherwise stated in the invoice.
3. **Discounts.** Cash discounts, if any, will apply only on the net amount of invoices sent to Buyer after deducting transportation charges, taxes and duties, and will be allowed only if (i) the invoice is paid according to Omron's payment terms and (ii) Buyer has no past due amounts.
4. **Interest.** Omron, at its option, may charge Buyer 1-1/2% interest per month or the maximum legal rate, whichever is less, on any balance not paid within the stated terms.
5. **Orders.** Omron will accept no order less than \$200 net billing.
6. **Governmental Approvals.** Buyer shall be responsible for, and shall bear all costs involved in, obtaining any government approvals required for the importation or sale of the Products.
7. **Taxes.** All taxes, duties and other governmental charges (other than general real property and income taxes), including any interest or penalties thereon, imposed directly or indirectly on Omron or required to be collected directly or indirectly by Omron for the manufacture, production, sale, delivery, importation, consumption or use of the Products sold hereunder (including customs duties and sales, excise, use, turnover and license taxes) shall be charged to and remitted by Buyer to Omron.
8. **Financial.** If the financial position of Buyer at any time becomes unsatisfactory to Omron, Omron reserves the right to stop shipments or require satisfactory security or payment in advance. If Buyer fails to make payment or otherwise comply with these Terms or any related agreement, Omron may (without liability and in addition to other remedies) cancel any unshipped portion of Products sold hereunder and stop any Products in transit until Buyer pays all amounts, including amounts payable hereunder, whether or not then due, which are owing to it by Buyer. Buyer shall in any event remain liable for all unpaid accounts.
9. **Cancellation; Etc.** Orders are not subject to rescheduling or cancellation unless Buyer indemnifies Omron against all related costs or expenses.
10. **Force Majeure.** Omron shall not be liable for any delay or failure in delivery resulting from causes beyond its control, including earthquakes, fires, floods, strikes or other labor disputes, shortage of labor or materials, accidents to machinery, acts of sabotage, riots, delay in or lack of transportation or the requirements of any government authority.
11. **Shipping; Delivery.** Unless otherwise expressly agreed in writing by Omron:
 - a. Shipments shall be by a carrier selected by Omron; Omron will not drop ship except in "break down" situations.
 - b. Such carrier shall act as the agent of Buyer and delivery to such carrier shall constitute delivery to Buyer;
 - c. All sales and shipments of Products shall be FOB shipping point (unless otherwise stated in writing by Omron), at which point title and risk of loss shall pass from Omron to Buyer; provided that Omron shall retain a security interest in the Products until the full purchase price is paid;
 - d. Delivery and shipping dates are estimates only; and
 - e. Omron will package Products as it deems proper for protection against normal handling and extra charges apply to special conditions.
12. **Claims.** Any claim by Buyer against Omron for shortage or damage to the Products occurring before delivery to the carrier must be presented in writing to Omron within 30 days of receipt of shipment and include the original transportation bill signed by the carrier noting that the carrier received the Products from Omron in the condition claimed.
13. **Warranties.** (a) **Exclusive Warranty.** Omron's exclusive warranty is that the Products will be free from defects in materials and workmanship for a period of twelve months from the date of sale by Omron (or such other period expressed in writing by Omron). Omron disclaims all other warranties, express or implied. (b) **Limitations.** OMRON MAKES NO WARRANTY OR REPRESENTATION, EXPRESS OR IMPLIED, ABOUT NON-INFRINGEMENT, MERCHANTABILITY OR FITNESS FOR A PARTICULAR PURPOSE OF THE PRODUCTS. BUYER ACKNOWLEDGES THAT IT ALONE HAS DETERMINED THAT THE PRODUCTS WILL SUITABLY MEET THE REQUIREMENTS OF THEIR INTENDED USE. Omron further disclaims all warranties and responsibility of any type for claims or expenses based on infringement by the Products or otherwise of any intellectual property right. (c) **Buyer Remedy.** Omron's sole obligation hereunder shall be, at Omron's election, to (i) replace (in the form originally shipped with Buyer responsible for labor charges for removal or replacement thereof) the non-complying Product, (ii) repair the non-complying Product, or (iii) repay or credit Buyer an amount equal to the purchase price of the non-complying Product; provided that in no event shall Omron be responsible for warranty, repair, indemnity or any other claims or expenses regarding the Products unless Omron's analysis confirms that the Products were properly handled, stored, installed and maintained and not subject to contamination, abuse, misuse or inappropriate modification. Return of any Products by Buyer must be approved in writing by Omron before shipment. Omron Companies shall not be liable for the suitability or unsuitability or the results from the use of Products in combination with any electrical or electronic components, circuits, system assemblies or any other materials or substances or environments. Any advice, recommendations or information given orally or in writing, are not to be construed as an amendment or addition to the above warranty. See <http://www.omron247.com> or contact your Omron representative for published information.
14. **Limitation on Liability; Etc.** OMRON COMPANIES SHALL NOT BE LIABLE FOR SPECIAL, INDIRECT, INCIDENTAL, OR CONSEQUENTIAL DAMAGES, LOSS OF PROFITS OR PRODUCTION OR COMMERCIAL LOSS IN ANY WAY CONNECTED WITH THE PRODUCTS, WHETHER SUCH CLAIM IS BASED IN CONTRACT, WARRANTY, NEGLIGENCE OR STRICT LIABILITY. Further, in no event shall liability of Omron Companies exceed the individual price of the Product on which liability is asserted.
15. **Indemnities.** Buyer shall indemnify and hold harmless Omron Companies and their employees from and against all liabilities, losses, claims, costs and expenses (including attorney's fees and expenses) related to any claim, investigation, litigation or proceeding (whether or not Omron is a party) which arises or is alleged to arise from Buyer's acts or omissions under these Terms or in any way with respect to the Products. Without limiting the foregoing, Buyer (at its own expense) shall indemnify and hold harmless Omron and defend or settle any action brought against such Companies to the extent based on a claim that any Product made to Buyer specifications infringed intellectual property rights of another party.
16. **Property; Confidentiality.** Any intellectual property in the Products is the exclusive property of Omron Companies and Buyer shall not attempt to duplicate it in any way without the written permission of Omron. Notwithstanding any charges to Buyer for engineering or tooling, all engineering and tooling shall remain the exclusive property of Omron. All information and materials supplied by Omron to Buyer relating to the Products are confidential and proprietary, and Buyer shall limit distribution thereof to its trusted employees and strictly prevent disclosure to any third party.
17. **Export Controls.** Buyer shall comply with all applicable laws, regulations and licenses regarding (i) export of products or information; (ii) sale of products to "forbidden" or other proscribed persons; and (iii) disclosure to non-citizens of regulated technology or information.
18. **Miscellaneous.** (a) **Waiver.** No failure or delay by Omron in exercising any right and no course of dealing between Buyer and Omron shall operate as a waiver of rights by Omron. (b) **Assignment.** Buyer may not assign its rights hereunder without Omron's written consent. (c) **Law.** These Terms are governed by the law of the jurisdiction of the home office of the Omron company from which Buyer is purchasing the Products (without regard to conflict of law principles). (d) **Amendment.** These Terms constitute the entire agreement between Buyer and Omron relating to the Products, and no provision may be changed or waived unless in writing signed by the parties. (e) **Severability.** If any provision hereof is rendered ineffective or invalid, such provision shall not invalidate any other provision. (f) **Setoff.** Buyer shall have no right to set off any amounts against the amount owing in respect of this invoice. (g) **Definitions.** As used herein, "including" means "including without limitation"; and "Omron Companies" (or similar words) mean Omron Corporation and any direct or indirect subsidiary or affiliate thereof.

Certain Precautions on Specifications and Use

1. **Suitability of Use.** Omron Companies shall not be responsible for conformity with any standards, codes or regulations which apply to the combination of the Product in the Buyer's application or use of the Product. At Buyer's request, Omron will provide applicable third party certification documents identifying ratings and limitations of use which apply to the Product. This information by itself is not sufficient for a complete determination of the suitability of the Product in combination with the end product, machine, system, or other application or use. Buyer shall be solely responsible for determining appropriateness of the particular Product with respect to Buyer's application, product or system. Buyer shall take application responsibility in all cases but the following is a non-exhaustive list of applications for which particular attention must be given:
 - (i) Outdoor use, uses involving potential chemical contamination or electrical interference, or conditions or uses not described in this document.
 - (ii) Use in consumer products or any use in significant quantities.
 - (iii) Energy control systems, combustion systems, railroad systems, aviation systems, medical equipment, amusement machines, vehicles, safety equipment, and installations subject to separate industry or government regulations.
 - (iv) Systems, machines and equipment that could present a risk to life or property. Please know and observe all prohibitions of use applicable to this Product.

NEVER USE THE PRODUCT FOR AN APPLICATION INVOLVING SERIOUS RISK TO LIFE OR PROPERTY OR IN LARGE QUANTITIES WITHOUT ENSURING THAT THE SYSTEM AS A WHOLE HAS BEEN DESIGNED TO ADDRESS THE RISKS, AND THAT THE OMRON'S PRODUCT IS PROPERLY RATED AND INSTALLED FOR THE INTENDED USE WITHIN THE OVERALL EQUIPMENT OR SYSTEM.
2. **Programmable Products.** Omron Companies shall not be responsible for the user's programming of a programmable Product, or any consequence thereof.
3. **Performance Data.** Data presented in Omron Company websites, catalogs and other materials is provided as a guide for the user in determining suitability and does not constitute a warranty. It may represent the result of Omron's test conditions, and the user must correlate it to actual application requirements. Actual performance is subject to the Omron's Warranty and Limitations of Liability.
4. **Change in Specifications.** Product specifications and accessories may be changed at any time based on improvements and other reasons. It is our practice to change part numbers when published ratings or features are changed, or when significant construction changes are made. However, some specifications of the Product may be changed without any notice. When in doubt, special part numbers may be assigned to fix or establish key specifications for your application. Please consult with your Omron's representative at any time to confirm actual specifications of purchased Product.
5. **Errors and Omissions.** Information presented by Omron Companies has been checked and is believed to be accurate; however, no responsibility is assumed for clerical, typographical or proofreading errors or omissions.

OMRON AUTOMATION AND SAFETY • THE AMERICAS HEADQUARTERS • Chicago, IL USA • 847.843.7900 • 800.556.6766 • www.omron247.com

OMRON CANADA, INC. • HEAD OFFICE

Toronto, ON, Canada • 416.286.6465 • 866.986.6766 • www.omron247.com

OMRON ELECTRONICS DE MEXICO • HEAD OFFICE

México DF • 52.55.59.01.43.00 • 01-800-226-6766 • mela@omron.com

OMRON ELECTRONICS DE MEXICO • SALES OFFICE

Apodaca, N.L. • 52.81.11.56.99.20 • 01-800-226-6766 • mela@omron.com

OMRON ELETRÔNICA DO BRASIL LTDA • HEAD OFFICE

São Paulo, SP, Brasil • 55.11.2101.6300 • www.omron.com.br

OMRON ARGENTINA • SALES OFFICE

Cono Sur • 54.11.4783.5300

OMRON CHILE • SALES OFFICE

Santiago • 56.9.9917.3920

OTHER OMRON LATIN AMERICA SALES

54.11.4783.5300

OMRON EUROPE B.V. • Wegalaan 67-69, NL-2132 JD, Hoofddorp, The Netherlands. • +31 (0) 23 568 13 00 • www.industrial.omron.eu

Authorized Distributor:

Automation Control Systems

- Machine Automation Controllers (MAC) • Programmable Controllers (PLC)
- Operator interfaces (HMI) • Distributed I/O • Software

Drives & Motion Controls

- Servo & AC Drives • Motion Controllers & Encoders

Temperature & Process Controllers

- Single and Multi-loop Controllers

Sensors & Vision

- Proximity Sensors • Photoelectric Sensors • Fiber-Optic Sensors
- Amplified Photomicrosensors • Measurement Sensors
- Ultrasonic Sensors • Vision Sensors

Industrial Components

- RFID/Code Readers • Relays • Pushbuttons & Indicators
- Limit and Basic Switches • Timers • Counters • Metering Devices
- Power Supplies

Safety

- Laser Scanners • Safety Mats • Edges and Bumpers • Programmable Safety Controllers • Light Curtains • Safety Relays • Safety Interlock Switches