

V60...V62, 3/2, 2 x 3/2, 5/2 or 5/3 Solenoid and pilot actuated spool valves

- > Port size: 1/8" ... 1/2" (NPT/ISO G)
- > High flow rate at small size
- > Proven sealing system, maintenance-free
- > Different manual override options available
- > Low power consumption
- > Manifold system for easy assembly
- > Different pressure ranges possible



Technical features

Medium:

Compressed air, filtered lubricated or non lubricated

Operation:

Electromagnetically or pneumatically controlled

Operating pressure:

-13 ... 145 psi (-0.9 ... 10 bar)
Details see following pages

Flow:

Cv 0.50...2.6 (500 ... 2600 l/min)

Flow direction:

Internal pilot supply: fixed
External pilot supply: optional

Port size:

1/8 NPT, 1/4 NPT, 3/8 NPT,
G1/8, G1/4, and G3/8

Mounting position:

Optional, spring return valves, preferably horizontal

Ambient/Media temperature:

+14 ... +122°F (-10 ... +50°C)
Air supply must be dry enough to avoid ice formation at temperatures below +35°F (+2°C).

Materials:

Housing: Aluminium bar stock.
Base plate: Aluminium
Static and dynamic seals: NBR and FPM
Plastic parts: PA, PBT with GF

Electrical details for solenoid operators

Voltage tolerance	± 10%	
Rating	100% continuous duty	
Inlet orifice	0,8 mm	
Electrical connection (corresponding to choosen coil)	EN 175301-803 - Form B, 22 mm	
	Industrial Standard, 22 mm	
Solenoid	4 x 90° rotatable	
Manual override	Push and turn to lock	code = 2
	Push only (not lockable)	code = 3
Protection class	IP 65 (with sealed plug)	

3/2 directional control valves, solenoid actuated

Symbol	Port size	Function	Actuation	Pilot supply	Flow Cv (l/min)	Operating pressure psi (bar)	Pilot pressure psi (bar)	Weight lbs. (kg)	Drawing No.	Model *1)
	1/8 NPT	NC	Solenoid/Spring	Internal	0.76 (750)	29 ... 145 (2 ... 10)	-	0.49 (.22)	1	V60P417A-A#*****
	1/4 NPT	NC	Solenoid/Spring	Internal	1.32 (1300)	29 ... 145 (2 ... 10)	-	0.64 (.29)	1	V61R417A-A#*****
	3/8 NPT	NC	Solenoid/Spring	Internal	2.64 (2600)	29 ... 145 (2 ... 10)	-	1.15 (.52)	1	V62S417A-A#*****
	1/8 NPT	NC	Solenoid/Air Spring	Internal	0.76 (750)	29 ... 145 (2 ... 10)	-	0.48 (.22)	3	V60P413A-A#*****
	1/4 NPT	NC	Solenoid/Air Spring	Internal	1.32 (1300)	29 ... 145 (2 ... 10)	-	0.63 (.29)	3	V61R413A-A#*****
	3/8 NPT	NC	Solenoid/Air Spring	Internal	2.64 (2600)	29 ... 145 (2 ... 10)	-	1.15 (.52)	3	V62S413A-A#*****
	1/8 NPT	NC	Solenoid/Air Spring	External	0.76 (750)	-13 ... 145 (-0.9 ... 10)	44 ... 145 (3 ... 10)	0.49 (.22)	3	V60P423A-A#*****
	1/4 NPT	NC	Solenoid/Air Spring	External	1.32 (1300)	-13 ... 145 (-0.9 ... 10)	44 ... 145 (3 ... 10)	0.64 (.29)	3	V61R423A-A#*****
	3/8 NPT	NC	Solenoid/Air Spring	External	2.64 (2600)	-13 ... 145 (-0.9 ... 10)	44 ... 145 (3 ... 10)	1.15 (.52)	3	V62S423A-A#*****
	1/8 NPT	NC	Solenoid/Solenoid	Internal	0.76 (750)	22 ... 145 (1.5 ... 10)	-	0.66 (.30)	7	V60P411A-A#*****
	1/4 NPT	NC	Solenoid/Solenoid	Internal	1.32 (1300)	22 ... 145 (1.5 ... 10)	-	0.84 (.38)	7	V61R411A-A#*****
	3/8 NPT	NC	Solenoid/Solenoid	Internal	2.64 (2600)	22 ... 145 (1.5 ... 10)	-	1.34 (.61)	7	V62S411A-A#*****

2 x 3/2 directional control valves, solenoid actuated

Symbol	Port size	Function	Actuation	Pilot supply	Flow Cv (l/min)	Operating pressure psi (bar)	Weight lbs. (kg)	Drawing No.	Model *1)
	1/8 NPT	NC/NC	Solenoid/Solenoid	Internal	0.51 (500)	29 ... 145 (2 ... 10)	0.75 (.34)	13	V60PA11A-A#*****
	1/4 NPT	NC/NC	Solenoid/Solenoid	Internal	0.97 (950)	29 ... 145 (2 ... 10)	0.95 (.43)	13	V61RA11A-A#*****
	3/8 NPT	NC/NC	Solenoid/Solenoid	Internal	1.93 (1900)	29 ... 145 (2 ... 10)	1.61 (.73)	13	V62SA11A-A#*****
	1/8 NPT	NO/NO	Solenoid/Solenoid	Internal	0.51 (500)	29 ... 145 (2 ... 10)	0.75 (.34)	13	V60PB11A-A#*****
	1/4 NPT	NO/NO	Solenoid/Solenoid	Internal	0.97 (950)	29 ... 145 (2 ... 10)	0.95 (.43)	13	V61RB11A-A#*****
	3/8 NPT	NO/NO	Solenoid/Solenoid	Internal	1.93 (1900)	29 ... 145 (2 ... 10)	1.61 (.73)	13	V62SB11A-A#*****
	1/8 NPT	NO/NC	Solenoid/Solenoid	Internal	0.51 (500)	29 ... 145 (2 ... 10)	0.75 (.34)	13	V60PC11A-A#*****
	1/4 NPT	NO/NC	Solenoid/Solenoid	Internal	0.97 (950)	29 ... 145 (2 ... 10)	0.95 (.43)	13	V61RC11A-A#*****
	3/8 NPT	NO/NC	Solenoid/Solenoid	Internal	1.93 (1900)	29 ... 145 (2 ... 10)	1.61 (.73)	13	V62SC11A-A#*****

*1) **** Insert manual override, voltage and connector codes (see tables below or page 5 for option selector)

Manual override code

2= push and turn
3= push only

NC = Normally closed
NO = Normally open
NC/NC = Both valves normally closed (port P)
NO/NO = Both valves normally open (port P)
NO/NC = Valve normally open, 1 valve normally closed (port P)

Voltage codes and spare coils

22 mm coil for connector interface acc. to industrial standard				
	Voltage	Power Inrush/Hold	Model	Code
	12 V d.c.	2 W	54469-01	12J
	24 V d.c.	2 W	54469-02	13J
	24 V 50/60 Hz	4/2,5 VA	54469-04	14J
	110/120V 50/60Hz	4/2,5 VA	54469-03	18J
	220/240V 50/60Hz	6/5,0 VA	54469-08	19J
	Blank	Blank	Blank	000

Connector plugs

Industrial standard 22 mm 2-pole + PE



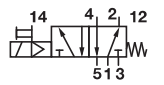
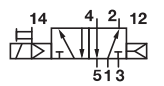
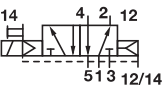
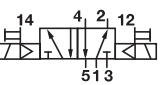

Connector Code	Description	Model
A	No connector	
B	Cable grip 0-240Vac/Vdc	54934-01
C	6 ft. molded cable, 0-240Vac/Vdc	54934-21
H	Cable grip w/indicator light 24 VDC	54934-08
J	Cable grip w/indicator light 24Vac	54934-02
Z	1/2" Conduit 0-240Vac/Vdc	54934-05
5	6 ft. molded cable w/ indicator light, surge suppression, 24Vac/Vdc	54934-30
6	6 ft. molded cable w/ indicator light, 120Vac/Vdc	54934-35

5/2 directional control valves, solenoid actuated

Symbol	Port size	Actuation	Pilot supply	Flow Cv (l/min)	Operating pressure psi (bar)	Pilot pressure psi (bar)	Weight lbs (kg)	Drawing No.	Model *1)
	1/8 NPT	Solenoid/Spring	Internal	0.76 (750)	44 ... 145 (3 ... 10)	-	0.49 (.22)	9	V60P517A-A#*****
	1/4 NPT	Solenoid/Spring	Internal	1.32 (1300)	44 ... 145 (3 ... 10)	-	0.64 (.29)	9	V61R517A-A#*****
	3/8 NPT	Solenoid/Spring	Internal	2.64 (2600)	44 ... 145 (3 ... 10)	-	1.15 (.52)	9	V62S517A-A#*****
	1/8 NPT	Solenoid/Air Spring	Internal	0.76 (750)	29 ... 145 (2 ... 10)	-	0.53 (.24)	11	V60P513A-A#*****
	1/4 NPT	Solenoid/Air Spring	Internal	1.32 (1300)	29 ... 145 (2 ... 10)	-	0.73 (.33)	11	V61R513A-A#*****
	3/8 NPT	Solenoid/Air Spring	Internal	2.64 (2600)	29 ... 145 (2 ... 10)	-	1.37 (.62)	11	V62S513A-A#*****
	1/8 NPT	Solenoid/Air Spring	External	0.76 (750)	-13 ... 145 (-0.9 ... 10)	44 ... 145 (3 ... 10)	0.53 (.24)	11	V60P523A-A#*****
	1/4 NPT	Solenoid/Air Spring	External	1.32 (1300)	-13 ... 145 (-0.9 ... 10)	44 ... 145 (3 ... 10)	0.73 (.33)	11	V61R523A-A#*****
	3/8 NPT	Solenoid/Air Spring	External	2.64 (2600)	-13 ... 145 (-0.9 ... 10)	44 ... 145 (3 ... 10)	1.37 (.62)	11	V62S523A-A#*****
	1/8 NPT	Solenoid/Solenoid	Internal	0.76 (750)	22 ... 145 (1.5 ... 10)	-	0.73 (.33)	13	V60P511A-A#*****
	1/4 NPT	Solenoid/Solenoid	Internal	1.32 (1300)	22 ... 145 (1.5 ... 10)	-	0.93 (.42)	13	V61R511A-A#*****
	3/8 NPT	Solenoid/Solenoid	Internal	2.64 (2600)	22 ... 145 (1.5 ... 10)	-	1.59 (.72)	13	V62S511A-A#*****

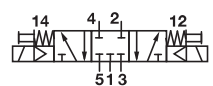
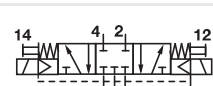
5/3 directional control valves, solenoid actuated

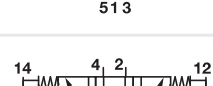
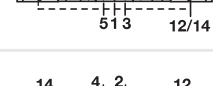
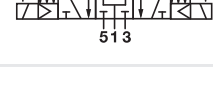
Symbol	Port size	Function	Actuation	Pilot supply	Flow Cv (l/min)	Operating pressure psi (bar)	Pilot pressure psi (bar)	Weight lbs (kg)	Drawing No.	Model *1)
	1/8 NPT	APB	Solenoid/Solenoid	Internal	0.51 (500)	44 ... 145 (3 ... 10)	-	0.77 (0.35)	15	V60P611A-A#*****
	1/4 NPT	APB	Solenoid/Solenoid	Internal	0.97 (950)	44 ... 145 (3 ... 10)	-	1.04 (0.47)	15	V61R611A-A#*****
	3/8 NPT	APB	Solenoid/Solenoid	Internal	1.93 (1900)	44 ... 145 (3 ... 10)	-	1.79 (0.81)	15	V62S611A-A#*****
	1/8 NPT	APB	Solenoid/Solenoid	External	0.51 (500)	-13 ... 145 (-0.9 ... 10)	44 ... 145 (3 ... 10)	0.77 (0.35)	15	V60P622A-A#*****
	1/4 NPT	APB	Solenoid/Solenoid	External	0.97 (950)	-13 ... 145 (-0.9 ... 10)	44 ... 145 (3 ... 10)	1.04 (0.47)	15	V61R622A-A#*****
	3/8 NPT	APB	Solenoid/Solenoid	External	1.93 (1900)	-13 ... 145 (-0.9 ... 10)	44 ... 145 (3 ... 10)	1.79 (0.81)	15	V62S622A-A#*****
	1/8 NPT	COE	Solenoid/Solenoid	Internal	0.51 (500)	44 ... 145 (3 ... 10)	-	0.77 (0.35)	15	V60P711A-A#*****
	1/4 NPT	COE	Solenoid/Solenoid	Internal	0.97 (950)	44 ... 145 (3 ... 10)	-	1.04 (0.47)	15	V61R711A-A#*****
	3/8 NPT	COE	Solenoid/Solenoid	Internal	1.93 (1900)	44 ... 145 (3 ... 10)	-	1.79 (0.81)	15	V62S711A-A#*****
	1/8 NPT	COE	Solenoid/Solenoid	External	0.51 (500)	-13 ... 145 (-0.9 ... 10)	44 ... 145 (3 ... 10)	0.77 (0.35)	15	V60P722A-A#*****
	1/4 NPT	COE	Solenoid/Solenoid	External	0.97 (950)	-13 ... 145 (-0.9 ... 10)	44 ... 145 (3 ... 10)	1.04 (0.47)	15	V61R722A-A#*****
	3/8 NPT	COE	Solenoid/Solenoid	External	1.93 (1900)	-13 ... 145 (-0.9 ... 10)	44 ... 145 (3 ... 10)	1.79 (0.81)	15	V62S722A-A#*****
	1/8 NPT	COP	Solenoid/Solenoid	Internal	0.51 (500)	44 ... 145 (3 ... 10)	-	0.77 (0.35)	15	V60P811A-A#*****
	1/4 NPT	COP	Solenoid/Solenoid	Internal	0.97 (950)	44 ... 145 (3 ... 10)	-	1.04 (0.47)	15	V61R811A-A#*****
	3/8 NPT	COP	Solenoid/Solenoid	Internal	1.93 (1900)	44 ... 145 (3 ... 10)	-	1.79 (0.81)	15	V62S811A-A#*****
	1/8 NPT	COP	Solenoid/Solenoid	External	0.51 (500)	-13 ... 145 (-0.9 ... 10)	44 ... 145 (3 ... 10)	0.77 (0.35)	15	V60P822A-A#*****
	1/4 NPT	COP	Solenoid/Solenoid	External	0.97 (950)	-13 ... 145 (-0.9 ... 10)	44 ... 145 (3 ... 10)	1.04 (0.47)	15	V61R822A-A#*****
	3/8 NPT	COP	Solenoid/Solenoid	External	1.93 (1900)	-13 ... 145 (-0.9 ... 10)	44 ... 145 (3 ... 10)	1.79 (0.81)	15	V62S822A-A#*****

*1) **** Insert manual override, voltage and connector codes (see tables below or page 5 for option selector)

COE = Center open exhaust
COP = Center open pressure

Manual override code

2= push and turn
3= push only

3/2 directional control valves, pilot actuated

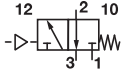
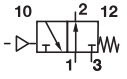
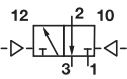
Symbol	Port size	Function	Actuation	Flow Cv (l/min)	Operating pressure psi (bar)	Pilot pressure external psi (bar)	Weight lbs (kg)	Drawing No.	Model
	1/8 NPT	NC	Air/Spring	0.76 (750)	-13 ... 145 (-0.9 ... 10)	36 ... 145 (2.5 ... 10)	0.29 (0.13)	31	V60P4D7A-XP0900
	1/4 NPT	NC	Air/Spring	1.32 (1300)	-13 ... 145 (-0.9 ... 10)	36 ... 145 (2.5 ... 10)	0.46 (0.21)	31	V61R4D7A-XP0900
	3/8 NPT	NC	Air/Spring	2.64 (2600)	-13 ... 145 (-0.9 ... 10)	36 ... 145 (2.5 ... 10)	0.95 (0.43)	33	V62S4D7A-XP0900
	1/8 NPT	NO	Air/Spring	0.76 (750)	-13 ... 145 (-0.9 ... 10)	36 ... 145 (2.5 ... 10)	0.29 (0.13)	32	V60P3D7A-XP0900
	1/4 NPT	NO	Air/Spring	1.32 (1300)	-13 ... 145 (-0.9 ... 10)	36 ... 145 (2.5 ... 10)	0.46 (0.21)	32	V61R3D7A-XP0900
	3/8 NPT	NO	Air/Spring	2.64 (2600)	-13 ... 145 (-0.9 ... 10)	36 ... 145 (2.5 ... 10)	0.95 (0.43)	34	V62S3D7A-XP0900
	1/8 NPT	NC	Air/Air	0.76 (750)	-13 ... 145 (-0.9 ... 10)	22 ... 145 (1.5 ... 10)	0.29 (0.13)	37	V60P4DDA-XP0200
	1/4 NPT	NC	Air/Air	1.32 (1300)	-13 ... 145 (-0.9 ... 10)	22 ... 145 (1.5 ... 10)	0.46 (0.21)	37	V61R4DDA-XP0200
	3/8 NPT	NC	Air/Air	2.64 (2600)	-13 ... 145 (-0.9 ... 10)	22 ... 145 (1.5 ... 10)	0.95 (0.43)	38	V62S4DDA-XP0200

2 x 3/2 directional control valves, pilot actuated

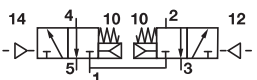
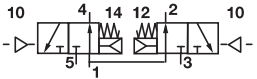
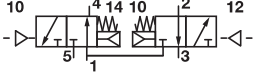
Symbol	Port size	Function	Actuation	Flow Cv (l/min)	Operating pressure psi (bar)	Pilot pressure external psi (bar)	Weight lbs (kg)	Drawing No.	Model
	1/8 NPT	NC/NC	Air/Air	0.51 (500)	29 ... 145 (2 ... 10)	29 ... 145 (2 ... 10)	0.40 (0.18)	43	V60PADDA-XP0200
	1/4 NPT	NC/NC	Air/Air	0.97 (950)	29 ... 145 (2 ... 10)	29 ... 145 (2 ... 10)	0.62 (0.28)	43	V61RADDA-XP0200
	3/8 NPT	NC/NC	Air/Air	1.93 (1900)	29 ... 145 (2 ... 10)	29 ... 145 (2 ... 10)	1.32 (0.60)	44	V62SADDA-XP0200
	1/8 NPT	NO/NO	Air/Air	0.51 (500)	29 ... 145 (2 ... 10)	29 ... 145 (2 ... 10)	0.40 (0.18)	43	V60PBDDA-XP0200
	1/4 NPT	NO/NO	Air/Air	0.97 (950)	29 ... 145 (2 ... 10)	29 ... 145 (2 ... 10)	0.62 (0.28)	43	V61RBDDA-XP0200
	3/8 NPT	NO/NO	Air/Air	1.93 (1900)	29 ... 145 (2 ... 10)	29 ... 145 (2 ... 10)	1.32 (0.60)	44	V62SBDDA-XP0200
	1/8 NPT	NO/NC	Air/Air	0.51 (500)	29 ... 145 (2 ... 10)	29 ... 145 (2 ... 10)	0.40 (0.18)	43	V60PCDDA-XP0200
	1/4 NPT	NO/NC	Air/Air	0.97 (950)	29 ... 145 (2 ... 10)	29 ... 145 (2 ... 10)	0.62 (0.28)	43	V61RCDDA-XP0200
	3/8 NPT	NO/NC	Air/Air	1.93 (1900)	29 ... 145 (2 ... 10)	29 ... 145 (2 ... 10)	1.32 (0.60)	44	V62SCDDA-XP0200

NC = Normally closed

NO = Normally open

NC/NC = Both valves normally closed (port P)

NO/NO = Both valves normally open (port P)

NO/NC = Valve normally open, 1 valve normally closed (port P) APB = All ports blocked

COE = Center open exhaust

COP = Center open pressure

5/2 directional control valves, pilot actuated

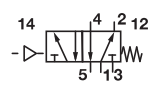
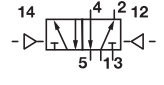
Symbol	Port size	Actuation	Flow (l/min)	Operating pressure (bar)	Pilot pressure external (bar)	Weight (kg)	Drawing No.	Model
	1/8 NPT	Air/Spring	0.76 (750)	-13 ... 145 (-0.9 ... 10)	36 ... 145 (2.5 ... 10)	0.35 (0.16)	40	V60P5D7A-XP0900
	1/4 NPT	Air/Spring	1.32 (1300)	-13 ... 145 (-0.9 ... 10)	36 ... 145 (2.5 ... 10)	0.57 (0.26)	40	V61R5D7A-XP0900
	3/8 NPT	Air/Spring	2.62 (2600)	-13 ... 145 (-0.9 ... 10)	36 ... 145 (2.5 ... 10)	1.23 (0.56)	41	V62S5D7A-XP0900
	1/2 NPT	Air/Spring	4.52 (4500)	-13 ... 145 (-0.9 ... 10)	44 ... 232 (3 ... 16)	2.03 (0.92)	42	V63D5D7A-XP0900
	1/8 NPT	Air/Air	0.76 (750)	-13 ... 145 (-0.9 ... 10)	22 ... 145 (1.5 ... 10)	0.37 (0.17)	43	V60P5DDA-XP0200
	1/4 NPT	Air/Air	1.32 (1300)	-13 ... 145 (-0.9 ... 10)	22 ... 145 (1.5 ... 10)	0.59 (0.27)	43	V61R5DDA-XP0200
	3/8 NPT	Air/Air	2.62 (2600)	-13 ... 145 (-0.9 ... 10)	22 ... 145 (1.5 ... 10)	1.28 (0.58)	44	V62S5DDA-XP0200
	1/2 NPT	Air/Air	4.52 (4500)	-13 ... 232 (-0.9 ... 16)	22 ... 232 (1.5 ... 16)	1.92 (0.87)	45	V63D5DDA-XP0200

5/3 directional control valves, pilot actuated

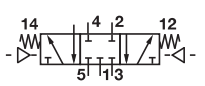
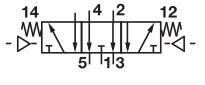
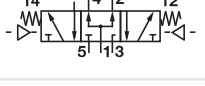
Symbol	Port size	Function	Actuation	Flow (l/min)	Operating pressure (bar)	Pilot pressure external (bar)	Weight (kg)	Drawing No.	Model
	1/8 NPT	APB	Air/Air	0.51 (500)	-13 ... 145 (-0.9 ... 10)	44 ... 145 (3 ... 10)	0.44 (0.20)	46	V60P6DDA-XP0200
	1/4 NPT	APB	Air/Air	0.97 (950)	-13 ... 145 (-0.9 ... 10)	44 ... 145 (3 ... 10)	0.71 (0.32)	46	V61R6DDA-XP0200
	3/8 NPT	APB	Air/Air	1.93 (1900)	-13 ... 145 (-0.9 ... 10)	44 ... 145 (3 ... 10)	1.47 (0.67)	47	V62S6DDA-XP0200
	1/2 NPT	APB	Air/Air	2.32 (2300)	-13 ... 145 (-0.9 ... 10)	44 ... 145 (3 ... 10)	2.43 (1.10)	48	V63D6DDA-XP0200
	1/8 NPT	COE	Air/Air	0.51 (500)	-13 ... 145 (-0.9 ... 10)	44 ... 145 (3 ... 10)	0.44 (0.20)	46	V60P7DDA-XP0200
	1/4 NPT	COE	Air/Air	0.97 (950)	-13 ... 145 (-0.9 ... 10)	44 ... 145 (3 ... 10)	0.71 (0.32)	46	V61R7DDA-XP0200
	3/8 NPT	COE	Air/Air	1.93 (1900)	-13 ... 145 (-0.9 ... 10)	44 ... 145 (3 ... 10)	1.47 (0.67)	47	V62S7DDA-XP0200
	1/2 NPT	COE	Air/Air	2.32 (2300)	-13 ... 145 (-0.9 ... 10)	44 ... 145 (3 ... 10)	2.43 (1.10)	48	V63D7DDA-XP0200
	1/8 NPT	COP	Air/Air	0.51 (500)	-13 ... 145 (-0.9 ... 10)	44 ... 145 (3 ... 10)	0.44 (0.20)	46	V60P8DDA-XP0200
	1/4 NPT	COP	Air/Air	0.97 (950)	-13 ... 145 (-0.9 ... 10)	44 ... 145 (3 ... 10)	0.71 (0.32)	46	V61R8DDA-XP0200
	3/8 NPT	COP	Air/Air	1.93 (1900)	-13 ... 145 (-0.9 ... 10)	44 ... 145 (3 ... 10)	1.47 (0.67)	47	V62S8DDA-XP0200

NO = Normally open

NC/NC = Both valves normally closed (port P)

NO/NO = Both valves normally open (port P)

NO/NC = Valve normally open, 1 valve normally closed (port P) APB = All ports blocked

COE = Center open exhaust

COP = Center open pressure

**Option selector
(directional control valves,
solenoid actuated)**

V6*****A-A*****

Valve size	Substitute
G1/8	0A
G1/4	1B
G3/8	2C
G1/2	3D
NPT-Valve size	Substitute
1/8 NPT	0P
1/4 NPT	1R
3/8 NPT	2S
1/2 NPT	3T
Function	Substitute
3/2 - NO	3
3/2 - NC	4
5/2	5
5/3 - APB	6
5/3 - COE	7
5/3 - COP	8
2 x 3/2 - NC	A
2 x 3/2 - NO	B
2 x 3/2 - NO/NC	C

Connector	Substitute	
No connector	A	
Cable grip 0-240Vac/Vdc	B	
6 ft. molded cable, 0-240Vac/Vdc	C	
Cable grip w/indicator light 24 VDC	H	
Cable grip w/indicator light 24Vac	J	
1/2" Conduit 0-240Vac/Vdc	Z	
6 ft. molded cable w/ indicator light, surge suppression, 24Vac/Vdc	5	
6 ft. molded cable w/ indicator light, 120Vac/Vdc	6	
Plug Interface	Substitute	
22 mm, industrial standard	J	
Voltage	Substitute	
12 V d.c. 2W	12	
24 V d.c. 2W	13	
24 V a.c. (50/60 Hz) 4/2,5 VA	14	
110/120 V a.c. (50/60 Hz) 4/2,5 VA	18	
220/240 V a.c. (50/60 Hz) 6/5 VA	19	
Manual override	Substitute	
Push, locked position	2	
Push only	3	
Actuation/Return	Pilot Supply	Substitute
Sol/Sol	Internal	11
Sol/Spring	Internal	17
Sol/Sol	External	22
Sol/Spring	External	27

**Option selector
(directional control
valves, pilot actuated)**

V6***D*A-X***00

Port size ISO G	Substitute
G1/8	0A
G1/4	1B
G3/8	2C
Port size NPT	Substitute
1/8 NPT	0P
1/4 NPT	1R
3/8 NPT	2S
Function	Substitute
3/2 - NO	3
3/2 - NC	4
5/2	5
5/3 - APB	6
5/3 - COE	7
5/3 - COP	8
2 x 3/2 - NC	A
2 x 3/2 - NO	B
2 x 3/2 - NO/NC	C

Actuation/Return	Substitute
Air/Air	02
Air/Spring	09
Pilot port	Substitute
G1/8	A
1/8 NPT	P
Return	Substitute
Air/Air	D
Air/Spring	7

Sub-bases

Series	Valve stations 2		3	
	ISO G	NPT	ISO G	NPT
V60	2221002	2221032	2221033	2221033
V61	2221102	2221132	2221103	2221133
V62	2221202	2221232	2221203	2221233

Accessories for sub-bases

Series	Blanking plate	Blanking plug for 2 station and 3 station manifolds	DIN rail mounting kit
	V60	0100561	0701208
V61	0100563	0701209	0101796
V62	0100565	0701210	0101796

Coil accessories

Diffusor for pilot exhaust	Circlip for coil fixing
81110800	81021600

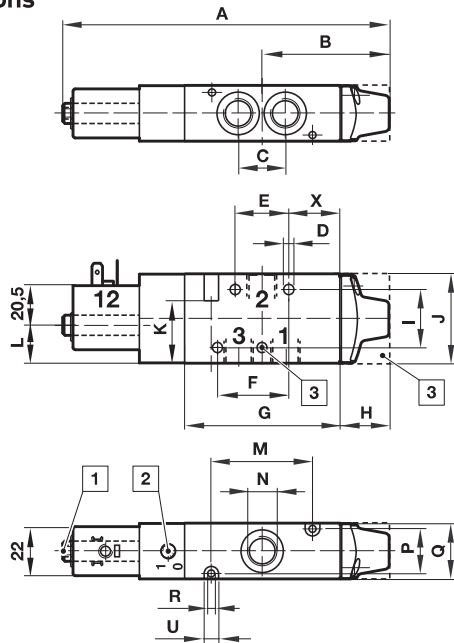
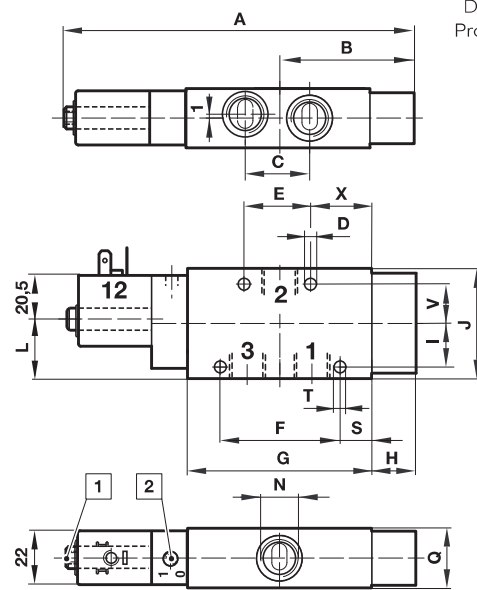
Dimensions
1

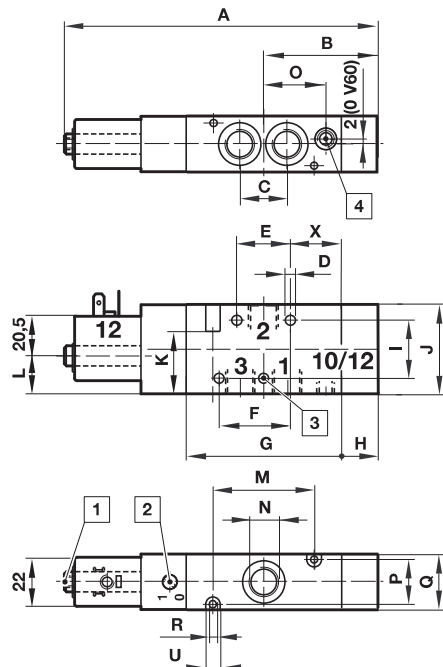
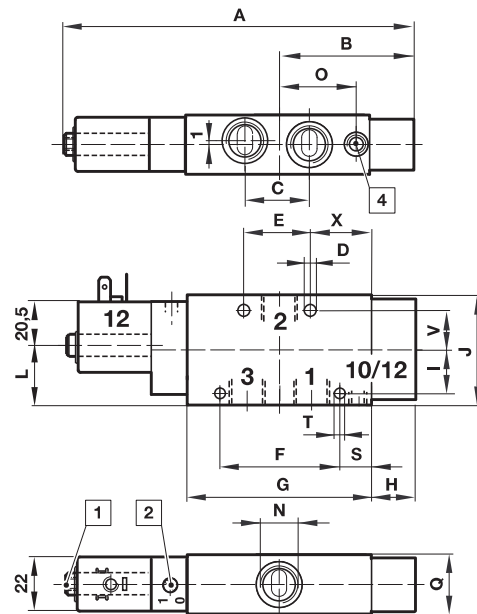
2

 Dimensions in inches
 Projection/First angle

3

4

1 Collected pilot exhaust (M5)

2 Manual Override

3 V62: Central mounting hole (left hole is not applicable) and square end cover

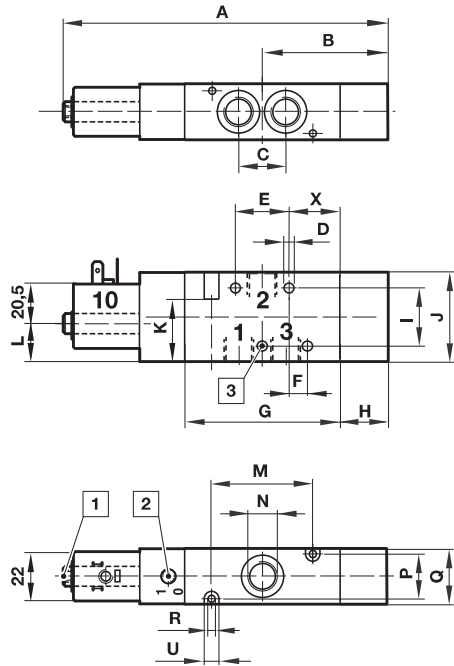
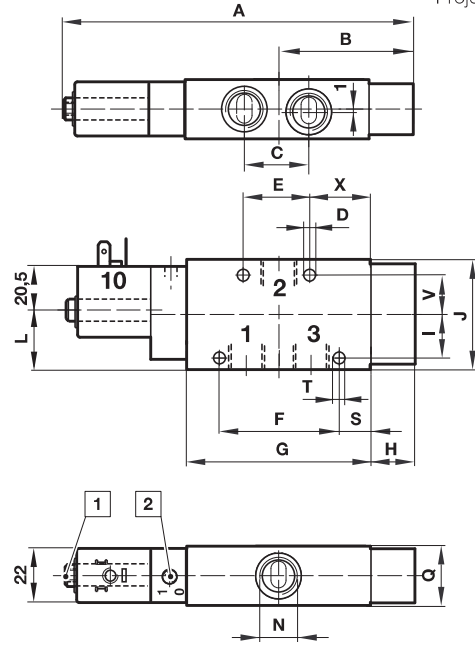
4 External pilot port, M5 or 10-32 UNF (V60, V61 & V62), G1/8 or 1/8-27 NPT (V63)

No.	A	B	C	ØD	E	F	G	H	I	J	K	L	M	N	O	P	Q	ØR	S	ØT	ØU	V	X	Model
1	4.92	1.77	0.63	0.18	0.71	0.98	2.20	0.67	1.02	1.38	1.10	0.47	1.38	1/8 NPT	—	0.67	0.87	0.13	—	—	0.26	—	0.75	V60P417A—...
1	5.79	2.26	0.83	0.18	0.94	1.26	2.76	0.89	1.02	1.57	1.10	0.67	1.81	1/4 NPT	—	0.79	0.98	0.13	—	—	0.26	—	0.91	V61R417A—...
1	6.56	2.76	0.96	0.18	1.02	—	3.29	1.10	1.42	2.17	1.73	1.26	2.13	3/8 NPT	—	1.10	1.34	0.18	—	—	0.31	0.91	1.18	V62S417A—...
3	4.59	1.46	0.63	0.18	0.71	0.98	2.20	0.35	1.02	1.38	1.10	0.47	1.38	1/8 NPT	—	0.67	0.87	0.13	—	—	0.26	—	0.75	V60P413A—...
3	5.22	1.69	0.83	0.18	0.94	1.26	2.76	0.31	1.02	1.57	1.10	0.67	1.81	1/4 NPT	—	0.79	0.98	0.13	—	—	0.26	—	0.91	V61R413A—...
3	5.79	1.99	0.96	0.18	1.02	—	3.29	0.35	1.42	2.17	1.73	1.26	2.13	3/8 NPT	—	1.10	1.34	0.18	—	—	0.31	—	1.18	V62S413A—...
3	4.59	1.46	0.63	0.18	0.71	0.98	2.20	0.35	1.02	1.38	1.10	0.47	1.38	1/8 NPT	0.87	0.67	0.87	0.13	—	—	0.26	—	0.75	V60P423A—...
3	5.22	1.69	0.83	0.18	0.94	1.26	2.76	0.31	1.02	1.57	1.10	0.67	1.81	1/4 NPT	1.14	0.79	0.98	0.13	—	—	0.26	—	0.91	V61R423A—...
3	5.79	1.99	0.96	0.18	1.02	—	3.29	0.35	1.42	2.17	1.73	1.26	2.13	3/8 NPT	—	1.10	1.34	0.18	—	—	0.31	—	1.18	V62S423A—...

5

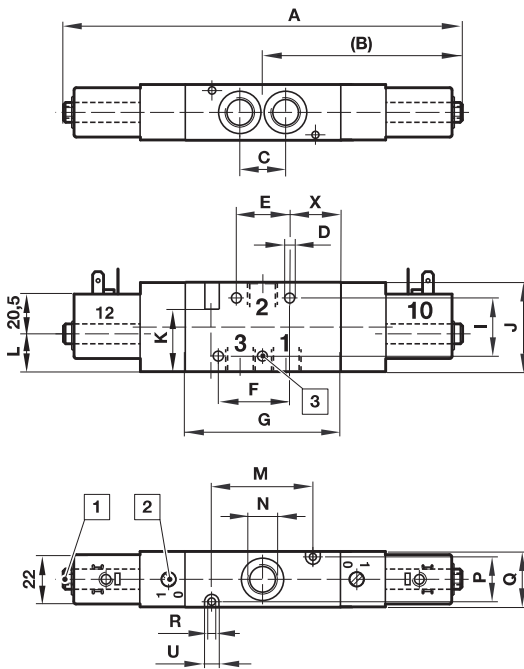
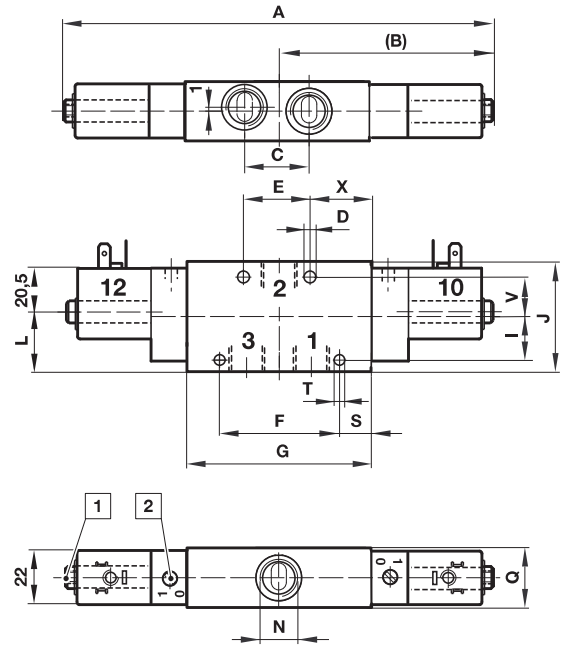
6

 Dimensions in inches
 Projection/First angle

7

8

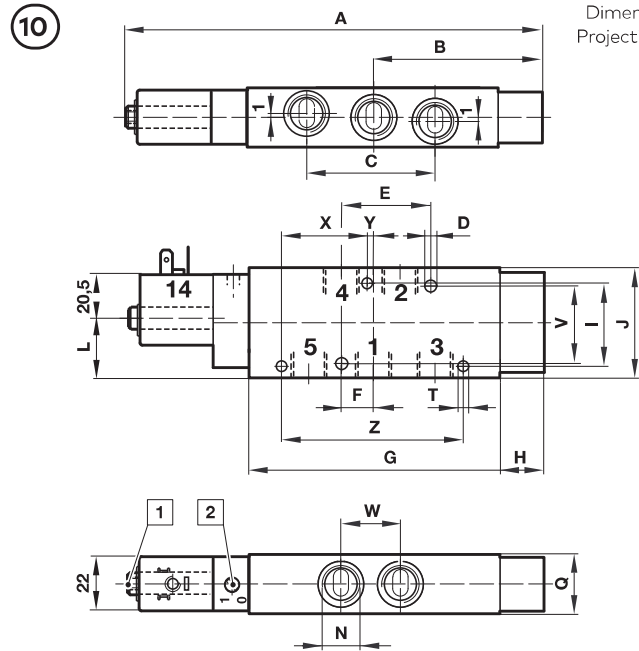
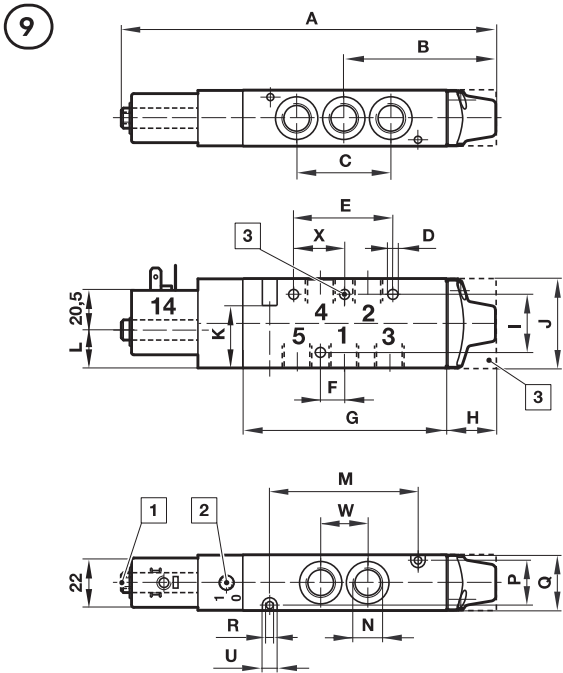
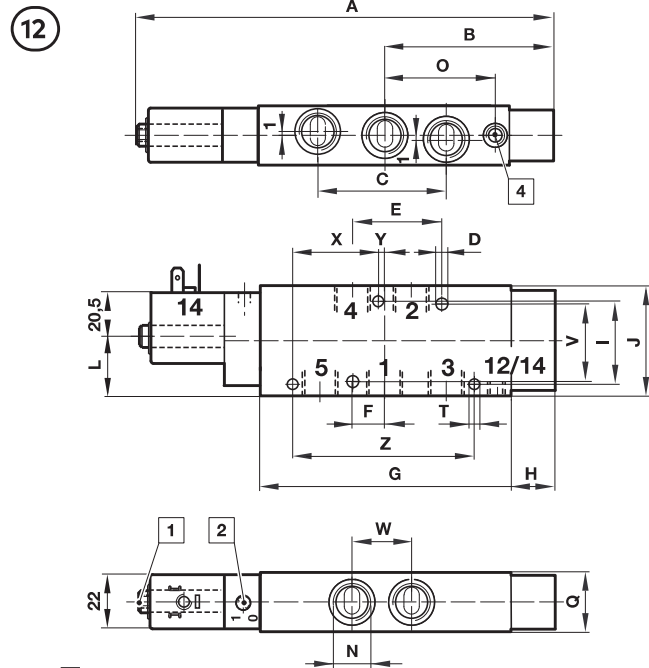
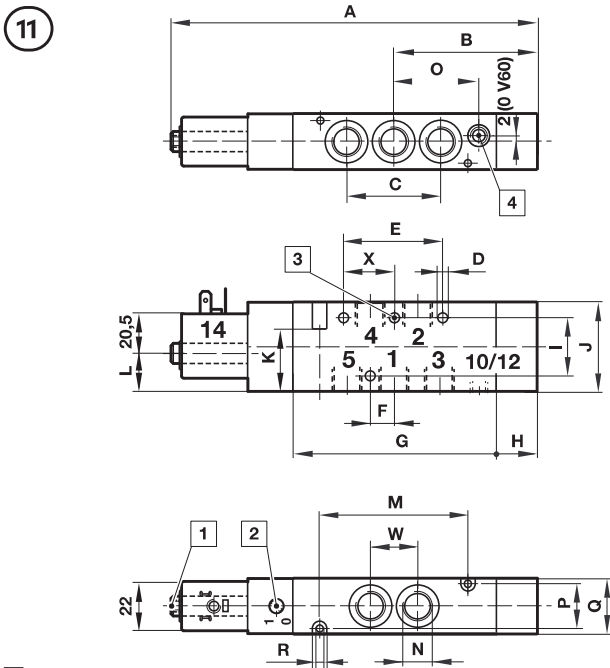
- 1** Collected pilot exhaust (M5)
- 2** Manual Override

- 3** V62: Central mounting hole (left hole is not applicable) and square end cover

No.	A	B	C	ØD	E	F	G	H	I	J	K	L	M	N	P	Q	ØR	S	ØT	ØU	V	X	Model
5	4.59	1.45	0.63	0.18	0.71	0.28	2.20	0.35	1.02	1.38	1.10	0.47	1.38	1/8 NPT	0.67	0.87	0.13	-	-	0.26	-	0.75	V60P313A-...
5	5.22	1.69	0.83	0.18	0.94	0.31	2.76	0.31	1.02	1.57	1.10	0.67	1.81	1/4 NPT	0.79	0.98	0.13	-	-	0.26	-	0.91	V61R313A-...
5	5.79	1.99	0.96	0.18	1.02	-	3.29	0.35	1.42	2.17	1.73	1.26	2.13	3/8 NPT	1.10	1.34	0.18	-	-	8.0	-	1.10	V62S313A-...
7	6.28	3.13	0.63	0.18	0.71	0.98	2.20	-	1.02	1.38	1.10	0.47	1.38	1/8 NPT	0.67	0.87	0.13	-	-	0.26	-	0.75	V60P411A-...
7	7.04	3.52	0.83	0.18	0.94	1.26	2.76	-	1.02	1.57	1.10	0.67	1.81	1/4 NPT	0.79	0.98	0.13	-	-	0.26	-	0.91	V61R411A-...
7	7.62	3.82	0.96	0.18	1.02	-	3.29	-	1.42	2.17	1.73	1.26	2.13	3/8 NPT	1.10	1.34	0.18	-	-	0.31	-	1.18	V62S411A-...



 Dimensions in inches
 Projection/First angle

- 1** Collected pilot exhaust (M5) \underline{U}
- 2** Manual Override

- 3** V62: Central mounting hole (left hole is not applicable) and square end cover
- 4** External pilot port, M5 or 10-32 UNF (V60, V61 & V62), G1/8 or 1/8-27 NPT (V63)

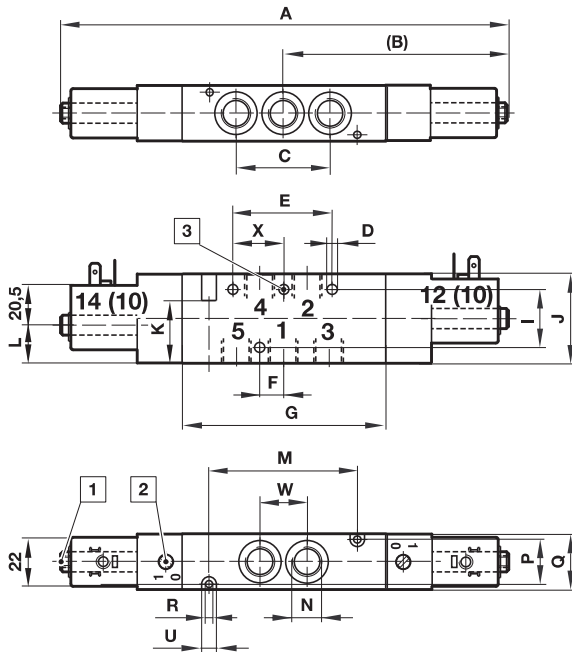
No.	A	B	C	ØD	E	F	G	H	I	J	K	L	M	N	O	P	Q	ØR	ØT	ØU	V	W	X	Y	Z	Model
9	5.51	2.07	1.28	0.18	1.32	0.31	2.80	0.67	1.02	1.38	1.10	0.47	1.97	1/8 NPT	—	0.67	0.87	0.13	—	0.26	—	0.63	0.67	—	—	V60P517A—...
9	6.57	2.66	1.65	0.18	1.73	0.39	3.54	0.89	1.02	1.57	1.10	0.67	2.60	1/4 NPT	—	0.79	0.98	0.13	—	0.26	—	0.83	0.87	—	—	V61R517A—...
9	7.52	3.23	1.93	0.18	—	0.47	4.25	1.10	1.42	2.17	1.73	1.26	3.07	3/8 NPT	—	1.10	1.34	0.18	—	0.31	—	0.96	1.02	—	—	V62S517A—...
11	5.20	1.75	1.28	0.18	1.32	0.31	2.80	0.35	1.02	1.38	1.10	0.47	1.97	1/8 NPT	—	0.67	0.87	0.13	—	0.26	—	0.63	0.67	—	—	V60P513A—...
11	6.02	2.08	1.65	0.18	1.73	0.39	3.54	0.31	1.02	1.57	1.10	0.67	2.60	1/4 NPT	—	0.79	0.98	0.13	—	0.26	—	0.83	0.87	—	—	V61R513A—...
11	6.75	2.46	1.93	0.18	—	0.47	4.25	0.33	1.42	2.17	1.73	1.26	3.07	3/8 NPT	—	1.10	1.34	0.18	—	0.31	—	0.96	1.02	—	—	V62S513A—...
11	5.20	1.75	1.28	0.18	1.32	0.31	2.80	0.35	1.02	1.38	1.10	0.47	1.97	1/8 NPT	1.16	0.67	0.87	0.13	—	0.26	—	0.63	0.67	—	—	V60P523A—...
11	6.02	2.09	1.65	0.18	1.73	0.39	3.54	0.31	1.02	1.57	1.10	0.67	2.60	1/4 NPT	1.53	0.79	0.98	0.13	—	0.26	—	0.83	0.87	—	—	V61R523A—...
11	6.75	2.46	1.93	0.18	—	0.47	4.25	0.31	1.02	2.17	1.73	1.26	3.07	3/8 NPT	1.89	1.10	1.34	0.18	—	0.31	—	0.96	1.02	—	—	V62S523A—...

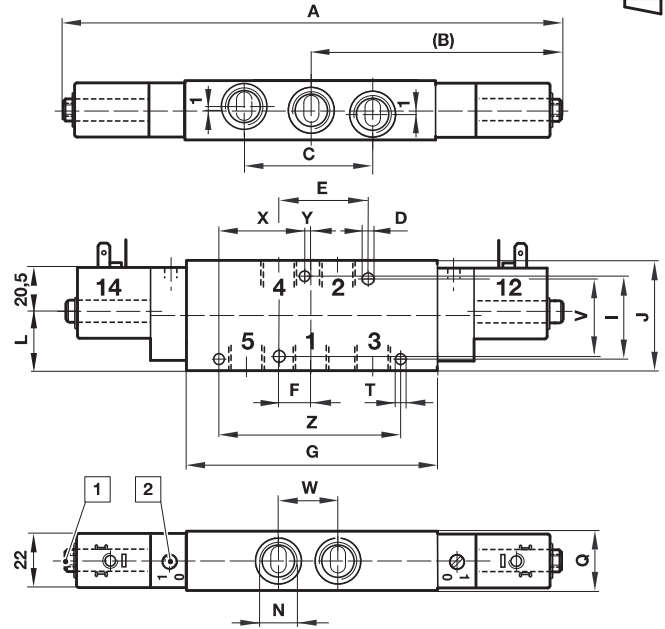
13

14

 Dimensions in inches
 Projection/First angle

- 1** Collected pilot exhaust (M5)
- 2** Manual Override
- 3** V62: Central mounting hole (left hole is not applicable)

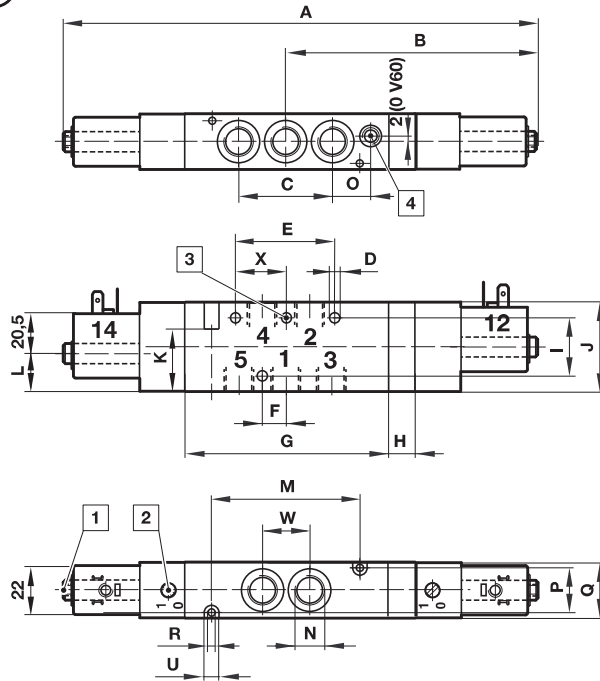
No.	A	B	C	ØD	E	F	G	I	J	K	L	M	N	P	Q	ØR	ØT	ØU	V	W	X	Y	Z	Model
13	6.87	3.44	1.28	0.18	1.32	0.31	2.80	1.02	1.38	1.10	0.47	1.97	1/8 NPT	0.67	0.87	0.13	—	0.26	—	0.63	0.67	—	—	V60P511A—...
13	6.87	3.44	1.28	0.18	1.32	0.31	2.80	1.02	1.38	1.10	0.47	1.97	1/8 NPT	0.67	0.87	0.13	—	0.26	—	0.63	0.67	—	—	V60PA11A—...
13	6.87	3.44	1.28	0.18	1.32	0.31	2.80	1.02	1.38	1.10	0.47	1.97	1/8 NPT	0.67	0.87	0.13	—	0.26	—	0.63	0.67	—	—	V60PB11A—...
13	6.87	3.44	1.28	0.18	1.32	0.31	2.80	1.02	1.38	1.10	0.47	1.97	1/8 NPT	0.67	0.87	0.13	—	0.26	—	0.63	0.67	—	—	V60PC11A—...
13	7.83	3.92	1.65	0.18	1.73	0.39	3.54	1.02	1.57	1.10	0.67	2.60	1/4 NPT	0.79	0.98	0.13	—	0.26	—	0.83	0.87	—	—	V61R511A—...
13	7.83	3.92	1.65	0.18	1.73	0.39	3.54	1.02	1.57	1.10	0.67	2.60	1/4 NPT	0.79	0.98	0.13	—	0.26	—	0.83	0.87	—	—	V61RA11A—...
13	7.83	3.92	1.65	0.18	1.73	0.39	3.54	1.02	1.57	1.10	0.67	2.60	1/4 NPT	0.79	0.98	0.13	—	0.26	—	0.83	0.87	—	—	V61RB11A—...
13	7.83	3.92	1.65	0.18	1.73	0.39	3.54	1.02	1.57	1.10	0.67	2.60	1/4 NPT	0.79	0.98	0.13	—	0.26	—	0.83	0.87	—	—	V61RC11A—...
13	8.58	4.29	1.93	0.18	—	0.47	4.25	1.42	2.17	1.73	1.26	3.07	3/8 NPT	1.10	1.34	0.18	—	0.31	—	0.96	1.02	—	—	V62S511A—...
13	8.58	4.29	1.93	0.18	—	0.47	4.25	1.42	2.17	1.73	1.26	3.07	3/8 NPT	1.10	1.34	0.18	—	0.31	—	0.96	1.02	—	—	V62SA11A—...
13	8.58	4.29	1.93	0.18	—	0.47	4.25	1.42	2.17	1.73	1.26	3.07	3/8 NPT	1.10	1.34	0.18	—	0.31	—	0.96	1.02	—	—	V62SB11A—...
13	8.58	4.29	1.93	0.18	—	0.47	4.25	1.42	2.17	1.73	1.26	3.07	3/8 NPT	1.10	1.34	0.18	—	0.31	—	0.96	1.02	—	—	V62SC11A—...

15

 Dimensions in inches
 Projection/First angle

- 1** Collected pilot exhaust (M5)
- 2** Manual Override
- 3** V62: Central mounting hole (left hole is not applicable) and square end cover
- 4** External pilot port, M5 or 10-32 UNF (V60, V61 & V62)

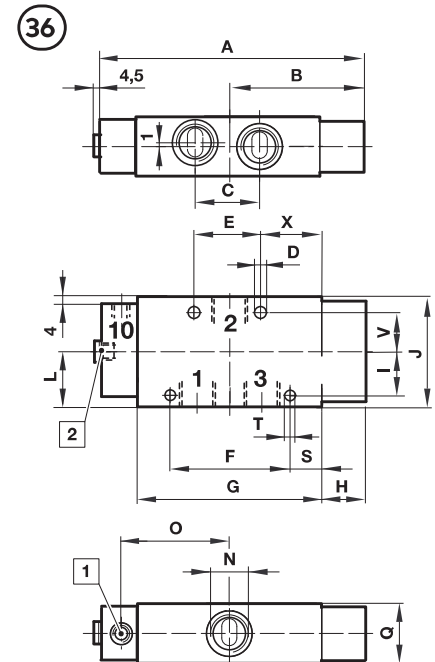
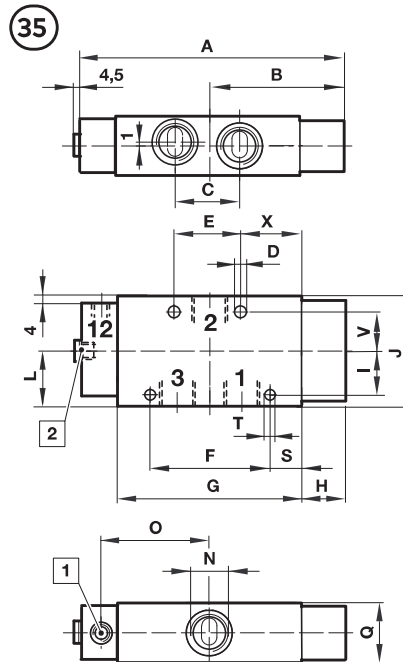
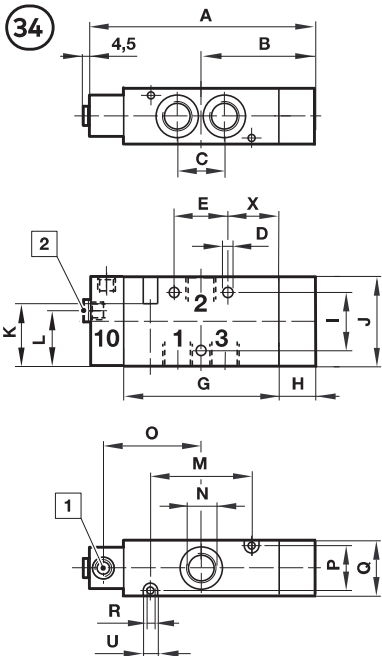
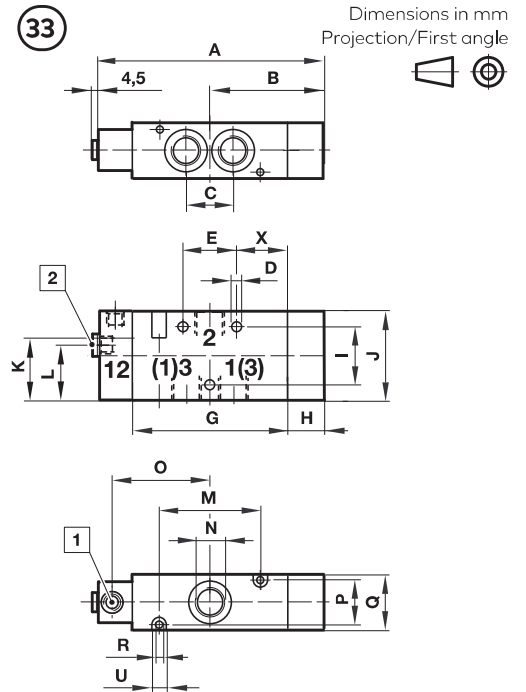
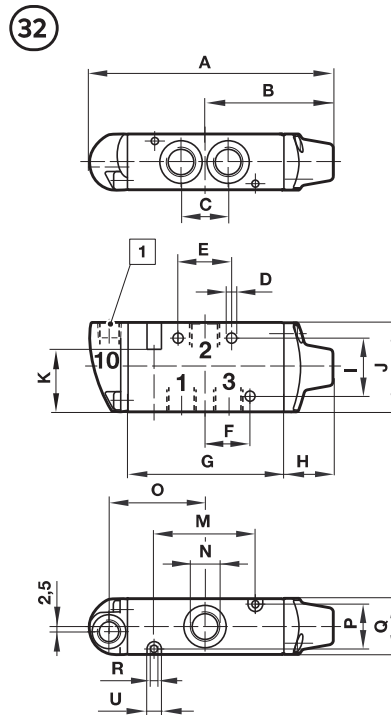
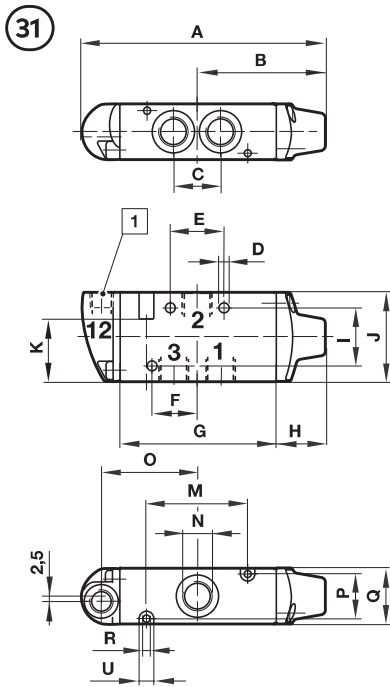
No.	A	B	C	ØD	E	F	G	H	I	J	K	L	M	N	O	P	Q	ØR	ØU	W	X	Model
15	7.42	4.00	1.28	0.18	1.32	0.31	2.80	0.55	1.02	1.38	1.10	0.47	1.97	1/8 NPT	0.51	0.67	0.87	0.13	0.26	0.63	0.67	V60P611A—...
15	7.42	4.00	1.28	0.18	1.32	0.31	2.80	0.55	1.02	1.38	1.10	0.47	1.97	1/8 NPT	0.51	0.67	0.87	0.13	0.26	0.63	0.67	V60P622A—...
15	7.42	4.00	1.28	0.18	1.32	0.31	2.80	0.55	1.02	1.38	1.10	0.47	1.97	1/8 NPT	0.51	0.67	0.87	0.13	0.26	0.63	0.67	V60P711A—...
15	7.42	4.00	1.28	0.18	1.32	0.31	2.80	0.55	1.02	1.38	1.10	0.47	1.97	1/8 NPT	0.51	0.67	0.87	0.13	0.26	0.63	0.67	V60P722A—...
15	7.42	4.00	1.28	0.18	1.32	0.31	2.80	0.55	1.02	1.38	1.10	0.47	1.97	1/8 NPT	0.51	0.67	0.87	0.13	0.26	0.63	0.67	V60P811A—...
15	7.42	4.00	1.28	0.18	1.32	0.31	2.80	0.55	1.02	1.38	1.10	0.47	1.97	1/8 NPT	0.51	0.67	0.87	0.13	0.26	0.63	0.67	V60P822A—...
15	8.54	4.63	1.65	0.18	1.73	0.39	3.54	0.71	1.02	1.57	1.10	0.67	2.60	1/4 NPT	0.71	0.79	0.98	0.13	0.26	0.83	0.87	V61R611A—...
15	8.54	4.63	1.65	0.18	1.73	0.39	3.54	0.71	1.02	1.57	1.10	0.67	2.60	1/4 NPT	0.71	0.79	0.98	0.13	0.26	0.83	0.87	V61R622A—...
15	8.54	4.63	1.65	0.18	1.73	0.39	3.54	0.71	1.02	1.57	1.10	0.67	2.60	1/4 NPT	0.71	0.79	0.98	0.13	0.26	0.83	0.87	V61R711A—...
15	8.54	4.63	1.65	0.18	1.73	0.39	3.54	0.71	1.02	1.57	1.10	0.67	2.60	1/4 NPT	0.71	0.79	0.98	0.13	0.26	0.83	0.87	V61R722A—...
15	8.54	4.63	1.65	0.18	1.73	0.39	3.54	0.71	1.02	1.57	1.10	0.67	2.60	1/4 NPT	0.71	0.79	0.98	0.13	0.26	0.83	0.87	V61R811A—...
15	8.54	4.63	1.65	0.18	1.73	0.39	3.54	0.71	1.02	1.57	1.10	0.67	2.60	1/4 NPT	0.71	0.79	0.98	0.13	0.26	0.83	0.87	V61R822A—...
15	9.47	5.18	1.93	0.18	—	0.47	4.25	0.89	1.42	2.17	1.73	1.26	3.07	3/8 NPT	0.93	1.10	1.34	0.18	0.31	0.96	1.02	V62S611A—...
15	9.47	5.18	1.93	0.18	—	0.47	4.25	0.89	1.42	2.17	1.73	1.26	3.07	3/8 NPT	0.93	1.10	1.34	0.18	0.31	0.96	1.02	V62S622A—...
15	9.47	5.18	1.93	0.18	—	0.47	4.25	0.89	1.42	2.17	1.73	1.26	3.07	3/8 NPT	0.93	1.10	1.34	0.18	0.31	0.96	1.02	V62S711A—...
15	9.47	5.18	1.93	0.18	—	0.47	4.25	0.89	1.42	2.17	1.73	1.26	3.07	3/8 NPT	0.93	1.10	1.34	0.18	0.31	0.96	1.02	V62S722A—...
15	9.47	5.18	1.93	0.18	—	0.47	4.25	0.89	1.42	2.17	1.73	1.26	3.07	3/8 NPT	0.93	1.10	1.34	0.18	0.31	0.96	1.02	V62S811A—...
15	9.47	5.18	1.93	0.18	—	0.47	4.25	0.89	1.42	2.17	1.73	1.26	3.07	3/8 NPT	0.93	1.10	1.34	0.18	0.31	0.96	1.02	V62S811A—...



1 Pilot ports G1/8 or 1/8-27 NPT

2 Alternative pilot ports G1/8 or 1/8-27 NPT

No.	A	B	C	ØD	E	F	G	H	I	J	K	L	M	N	O	P	Q	ØR	S	ØT	ØU	V	X	Model
31	3.52	1.77	0.63	0.18	0.71	0.63	2.20	0.67	1.02	1.38	1.10	—	1.38	1/8 NPT	1.42	0.67	0.87	0.13	—	—	0.26	—	—	V60P4D7A—...
31	4.33	2.26	0.83	0.18	0.94	0.79	2.76	0.89	1.02	1.57	1.10	—	1.81	1/4 NPT	1.69	0.79	0.98	0.13	—	—	0.26	—	—	V61R4D7A—...
32	3.52	1.77	0.63	0.18	0.71	0.63	2.20	0.67	1.02	1.38	1.10	—	1.38	1/8 NPT	1.42	0.67	0.87	0.13	—	—	0.26	—	—	V60P3D7A—...
32	4.33	2.26	0.83	0.18	0.94	0.79	2.76	0.89	1.02	1.57	1.10	—	1.81	1/4 NPT	1.69	0.79	0.98	0.13	—	—	0.26	—	—	V61R3D7A—...
33	5.20	2.76	0.96	0.18	1.02	—	3.29	1.10	1.42	2.17	—	1.32	2.13	3/8 NPT	2.05	1.10	1.34	0.18	—	—	0.31	—	1.18	V62S4D7A—...
34	5.20	2.76	0.96	0.18	1.02	—	3.29	1.10	1.42	2.17	—	1.32	2.13	3/8 NPT	2.05	1.10	1.34	0.18	—	—	0.31	—	1.10	V62S3D7A—...

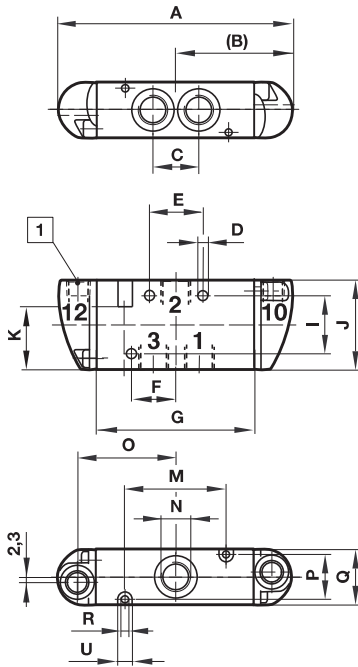
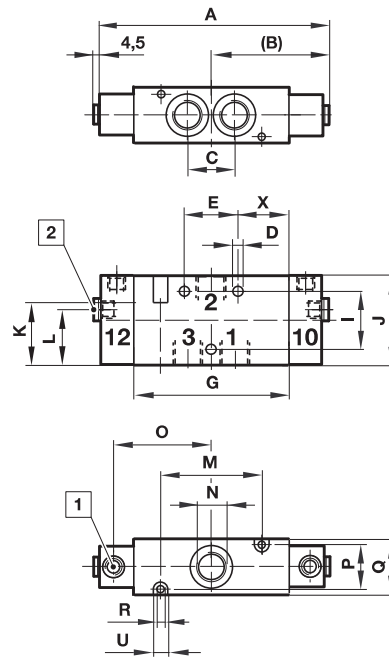
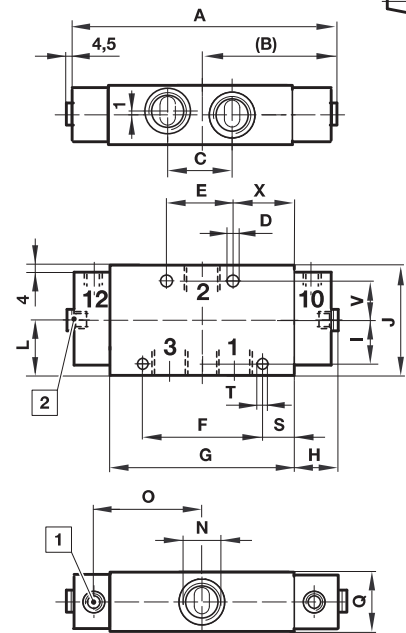
37

38

39

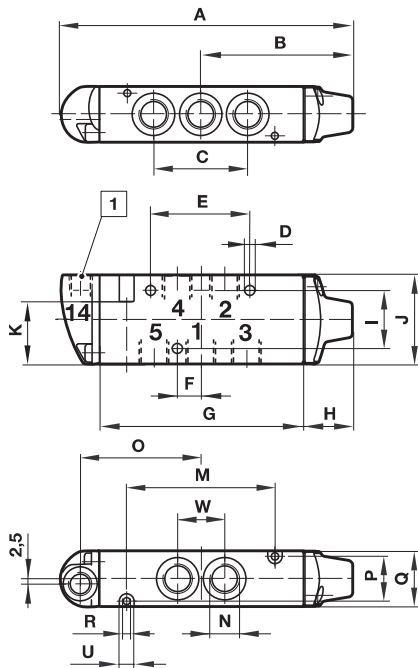
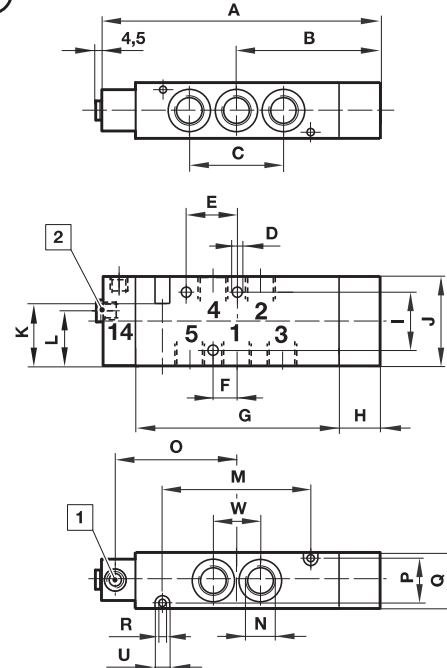
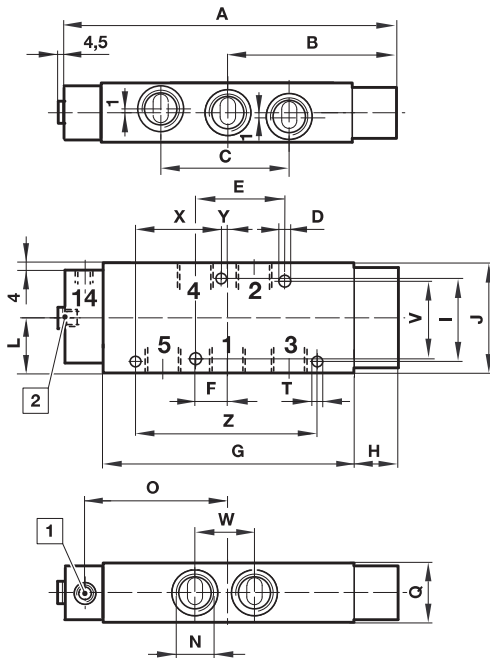
 Dimensions in mm
 Projection/First angle



- 1** Pilot ports G1/8 or 1/8-27 NPT
- 2** Alternative pilot ports G1/8 or 1/8-27 NPT

No.	A	B	C	D	E	F	G	I	J	K	L	M	N	O	P	Q	R	S	T	U	V	X	Model
37	3.50	1.75	0.63	0.18	0.71	0.63	2.20	1.02	1.38	1.10	—	1.38	1/8 NPT	1.42	0.67	0.87	0.13	—	—	0.26	—	—	V60P4DDA—...
37	4.09	2.05	0.83	0.18	0.94	0.79	2.76	1.02	1.57	1.10	—	1.81	1/4 NPT	1.69	0.79	0.98	0.13	—	—	0.26	—	—	V61R4DDA—...
38	4.88	2.44	0.96	0.18	1.02	—	3.29	1.42	2.17	1.73	1.32	2.13	3/8 NPT	2.05	1.10	1.34	0.18	—	—	0.31	—	1.18	V62S4DDA—...

40

41

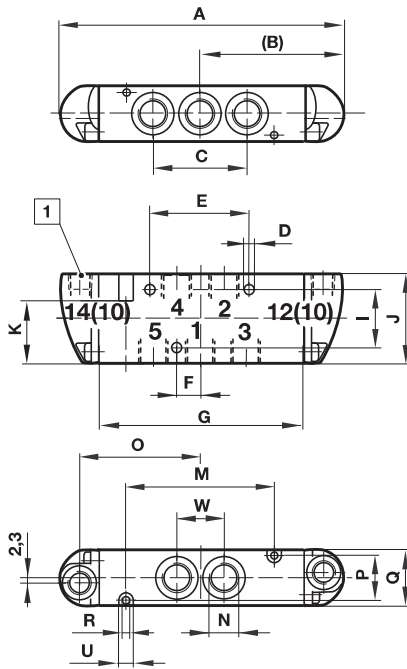
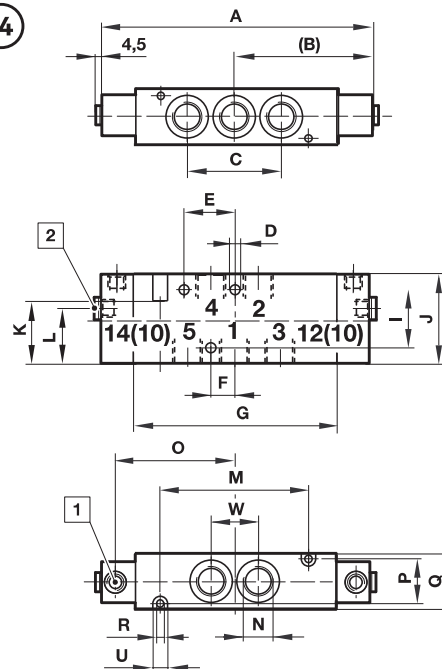
42

1 Pilot ports G1/8 or 1/8-27 NPT

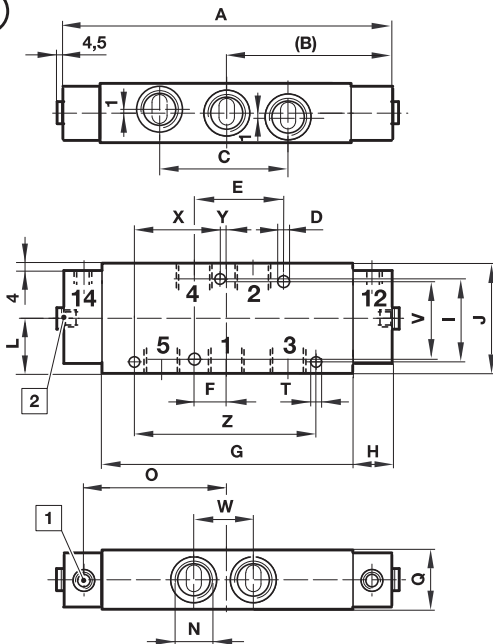
2 Alternative pilot ports G1/8 or 1/8-27 NPT

No.	A	B	C	D	E	F	G	H	I	J	K	L	M	N	O	P	Q	R	T	U	V	W	X	Y	Z	Model
40	4.13	2.07	1.28	0.18	1.32	0.31	2.80	0.67	1.02	1.38	1.10	—	1.97	1/8 NPT	1.71	0.67	0.87	0.13	—	0.26	—	0.63	—	—	—	V60P5D7A—...
40	5.12	2.66	1.65	0.18	1.73	0.39	3.54	0.89	1.02	1.57	1.10	—	2.60	1/4 NPT	2.09	0.79	0.98	0.13	—	0.26	—	0.83	—	—	—	V61R5D7A—...
41	6.14	3.23	1.93	0.18	1.02	0.47	4.25	1.10	1.42	2.17	1.73	1.32	3.07	3/8 NPT	2.52	1.10	1.34	0.18	—	0.31	—	0.96	—	—	—	V62S5D7A—...

43

44

 Dimensions in mm
 Projection/First angle

45

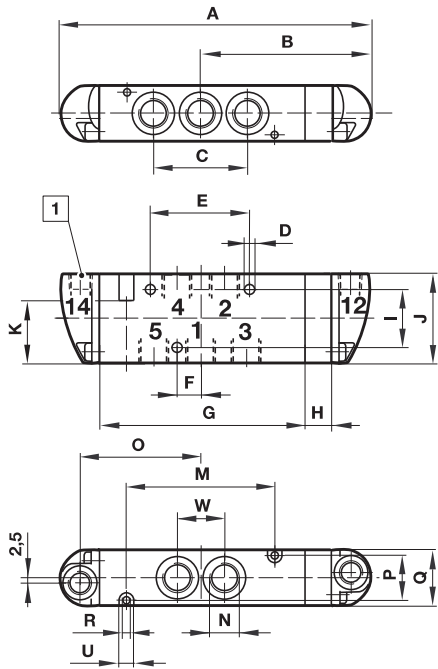
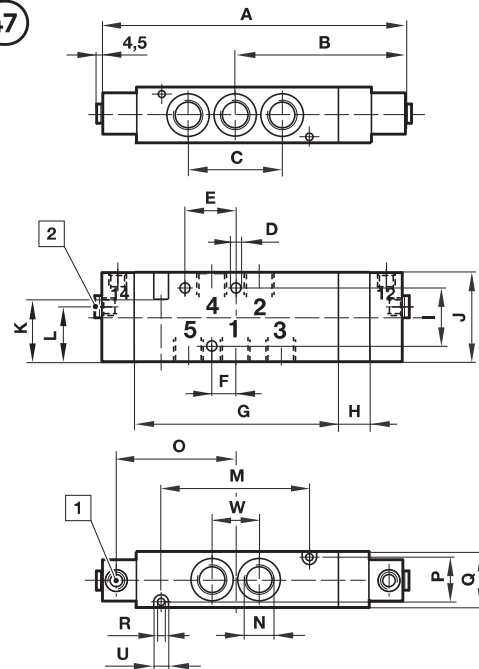
- 1 Pilot ports G1/8 or 1/8-27 NPT
- 2 Alternative pilot ports G1/8 or 1/8-27 NPT

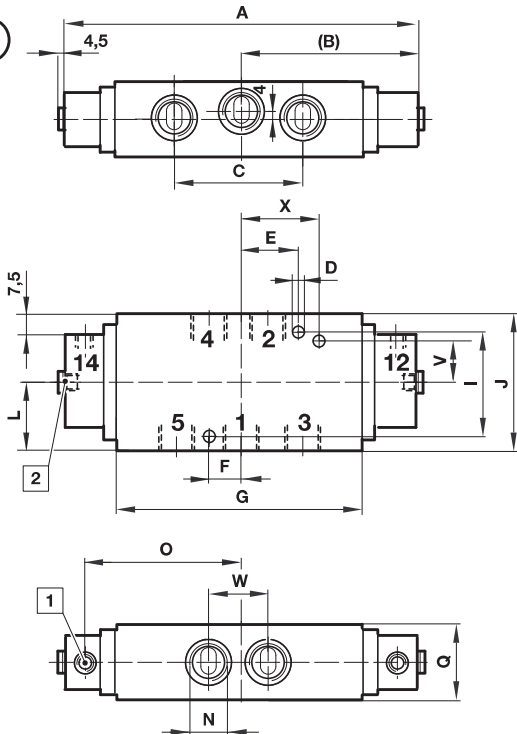
No.	A	B	C	D	E	F	G	H	I	J	K	L	M	N	O	P	Q	R	T	U	V	W	X	Z	Model
43	4.11	2.07	1.28	0.18	1.32	0.31	2.80	—	1.02	1.38	1.10	—	1.97	1/8 NPT	1.73	0.67	0.87	0.13	—	0.26	—	0.63	—	—	V60P5DDA—...
43	4.11	2.07	1.28	0.18	1.32	0.31	2.80	—	1.02	1.38	1.10	—	1.97	1/8 NPT	1.73	0.67	0.87	0.13	—	0.26	—	0.63	—	—	V60PADDA—...
43	4.11	2.07	1.28	0.18	1.32	0.31	2.80	—	1.02	1.38	1.10	—	1.97	1/8 NPT	1.73	0.67	0.87	0.13	—	0.26	—	0.63	—	—	V60PBDDA—...
43	4.11	2.07	1.28	0.18	1.32	0.31	2.80	—	1.02	1.38	1.10	—	1.97	1/8 NPT	1.73	0.67	0.87	0.13	—	0.26	—	0.63	—	—	V60PCDDA—...
43	4.88	2.44	1.65	0.18	1.73	0.39	3.54	—	1.02	1.57	1.10	—	2.60	1/4 NPT	2.08	0.79	0.98	0.13	—	0.26	—	0.83	—	—	V61R5DDA—...
43	4.88	2.44	1.65	0.18	1.73	0.39	3.54	—	1.02	1.57	1.10	—	2.60	1/4 NPT	2.08	0.79	0.98	0.13	—	0.26	—	0.83	—	—	V61RADDA—...
43	4.88	2.44	1.65	0.18	1.73	0.39	3.54	—	1.02	1.57	1.10	—	2.60	1/4 NPT	2.08	0.79	0.98	0.13	—	0.26	—	0.83	—	—	V61RBDDA—...
43	4.88	2.44	1.65	0.18	1.73	0.39	3.54	—	1.02	1.57	1.10	—	2.60	1/4 NPT	2.08	0.79	0.98	0.13	—	0.26	—	0.83	—	—	V61RCDDA—...
44	5.83	2.91	1.93	0.18	1.02	0.47	4.25	—	1.42	2.17	1.73	1.32	3.07	3/8 NPT	2.52	1.10	1.34	0.18	—	0.31	—	0.96	—	—	V62S5DDA—...
44	5.83	2.91	1.93	0.18	1.02	0.47	4.25	—	1.42	2.17	1.73	1.32	3.07	3/8 NPT	2.52	1.10	1.34	0.18	—	0.31	—	0.96	—	—	V62SADDA—...
44	5.83	2.91	1.93	0.18	1.02	0.47	4.25	—	1.42	2.17	1.73	1.32	3.07	3/8 NPT	2.52	1.10	1.34	0.18	—	0.31	—	0.96	—	—	V62SBDDA—...
44	5.83	74	1.93	0.18	1.02	0.47	4.25	—	1.42	2.17	1.73	1.32	3.07	3/8 NPT	2.52	1.10	1.34	0.18	—	0.31	—	0.96	—	—	V62SCDDA—...

46

47

 Dimensions in inches
 Projection/First angle

48

- 1 Pilot ports G1/8 or 1/8-27 NPT
- 2 Alternative pilot ports G1/8 or 1/8-27 NPT

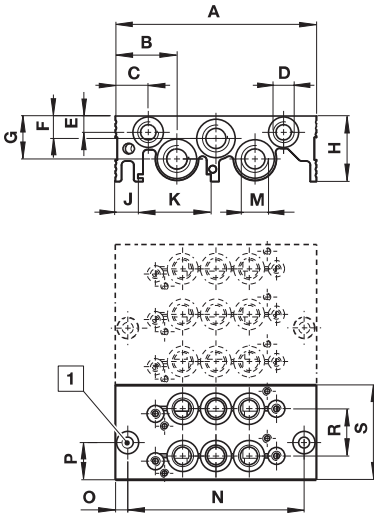
No.	A	B	C	D	E	F	G	H	I	J	K	L	M	N	O	P	Q	R	U	V	W	X	Model
46	4.67	2.60	1.28	0.18	1.32	0.31	2.80	0.55	1.02	1.38	1.10	—	1.97	1/8 NPT	1.71	0.67	0.87	0.13	0.26	—	0.63	—	V60P6DDA—...
46	4.67	2.60	1.28	0.18	1.32	0.31	2.80	0.55	1.02	1.38	1.10	—	1.97	1/8 NPT	1.71	0.67	0.87	0.13	0.26	—	0.63	—	V60P7DDA—...
46	4.67	2.60	1.28	0.18	1.32	0.31	2.80	0.55	1.02	1.38	1.10	—	1.97	1/8 NPT	1.71	0.67	0.87	0.13	0.26	—	0.63	—	V60P8DDA—...
46	5.60	3.15	1.65	0.18	1.73	0.39	3.54	0.71	1.02	1.57	1.10	—	2.60	1/4 NPT	2.09	0.79	0.98	0.13	0.26	—	0.83	—	V61R6DDA—...
46	5.60	3.15	1.65	0.18	1.73	0.39	3.54	0.71	1.02	1.57	1.10	—	2.60	1/4 NPT	2.09	0.79	0.98	0.13	0.26	—	0.83	—	V61R7DDA—...
46	5.60	3.15	1.65	0.18	1.73	0.39	3.54	0.71	1.02	1.57	1.10	—	2.60	1/4 NPT	2.09	0.79	0.98	0.13	0.26	—	0.83	—	V61R8DDA—...
47	6.71	3.80	1.93	0.18	1.02	0.47	4.25	0.89	1.42	2.17	1.73	1.32	3.07	3/8 NPT	2.52	1.10	1.34	0.18	0.31	—	0.96	—	V62S6DDA—...
47	6.71	3.80	1.93	0.18	1.02	0.47	4.25	0.89	1.42	2.17	1.73	1.32	3.07	3/8 NPT	2.52	1.10	1.34	0.18	0.31	—	0.96	—	V62S7DDA—...
47	6.71	3.80	1.93	0.18	1.02	0.47	4.25	0.89	1.42	2.17	1.73	1.32	3.07	3/8 NPT	2.52	1.10	1.34	0.18	0.31	—	0.96	—	V62S8DDA—...

Sub bases 2 and 3 stations



Sub bases 4 to 12 stations

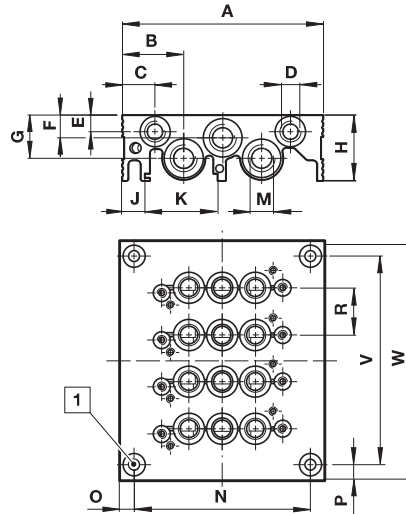

Dimensions in inches
Projection/First angle



1 For M5 bolts only

Series	Valve— stations	A	B	C	D	E	F	G	H	J	K	M	N	O	P	R	S	V *2)	W *2)	Weight lbs. (kg) *2)	Model NPT	Model ISO G
V60	2	3.86	1.18	0.63	1/8	0.31	0.43	0.83	1.26	0.43	1.40	1/4	3.39	0.24	1.10	0.91	1.81	—	1.81	0.51 (0.23)	2221022	2221002
V60	3	3.86	1.18	0.63	1/8	0.31	0.43	0.83	1.26	0.43	1.40	1/4	3.39	0.24	1.10	0.91	2.72	—	2.72	0.62 (0.28)	2221033	2221003
V61	2	4.09	1.02	0.35	1/8	0.31	0.51	0.79	1.30	0.39	1.40	3/8	0.94	1.57	1.02	1.02	2.05	—	2.05	0.62 (0.28)	2221132	2221102
V61	3	4.09	1.02	0.35	1/8	0.31	0.51	0.79	1.30	0.39	1.40	3/8	0.94	1.57	2.04	1.02	3.07	—	3.07	0.99 (0.45)	2221133	2221103
V62	2	4.72	1.14	0.35	1/8	0.31	0.59	0.87	1.50	0.47	1.40	1/2	1.26	1.73	1.38	1.38	2.76	—	2.76	1.10 (0.50)	2221232	2221202
V62	3	4.72	1.14	0.35	1/8	0.31	0.59	0.87	1.50	0.47	1.40	1/2	1.26	1.73	2.76	1.38	4.13	—	4.13	1.87 (0.85)	2221233	2221203

Extension possibilities of sub-bases

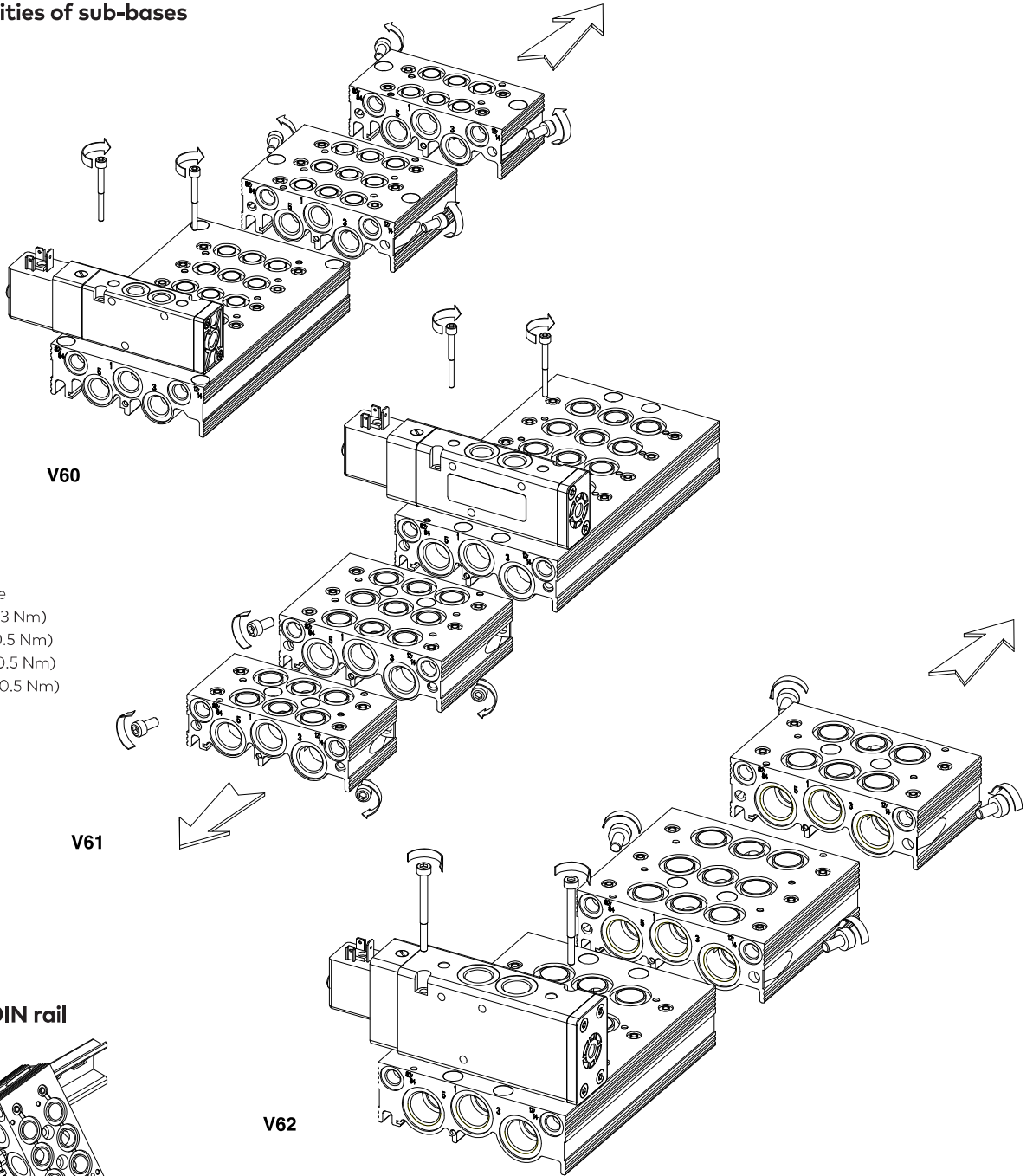

V60

V61

V62

Screw torque for sub-base
M3 = 6.2 +2.7 in-lb (0.7 +0.3 Nm)
M4 = 14.2 +4.4 in-lb (1.6 +0.5 Nm)
M5 = 30.1 +4.4 in-lb (3.4 +0.5 Nm)
M6 = 46.0 +4.4 in-lb (5.2 +0.5 Nm)

Mounting kit for DIN rail

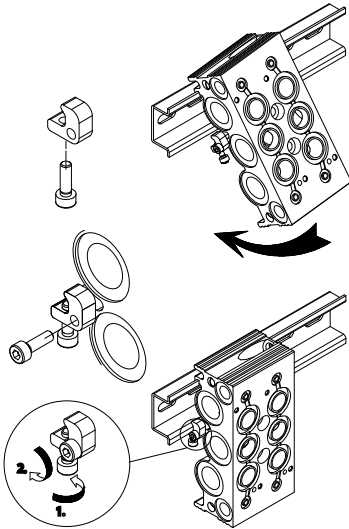

Warning

These products are intended for use in industrial compressed air systems only. Do not use these products where pressures and temperatures can exceed those listed under **»Technical features/data«**. Before using these products with fluids other than those specified, for non-industrial applications, life-support systems or other applications not within published specifications, consult IMI Precision Engineering. Through misuse, age, or malfunction, components used in fluid power systems can fail in various modes.

The system designer is warned to consider the failure modes of all component parts used in fluid power systems and to provide adequate safeguards to prevent personal injury or damage to equipment in the event of such failure. System designers must provide a warning to end users in the system instructional manual if protection against a failure mode cannot be adequately provided. System designers and end users are cautioned to review specific warnings found in instruction sheets packed and shipped with these products.