

SP4T NO Electro-Mechanical Relay Switch DC to 12 GHz , Up To 600W, 12V, 2M Lifecycles, N

The FMSW6434 is a Single Pole Four Throw (SP4T) electromechanical relay switch that operates across a wide frequency range of DC to 12 GHz and can handle up to 600 Watts of CW input power in a break before make condition. The 50 Ohm design is rated for 2 million lifecycles and features a Normally Open Actuator where the selected position remains active with constant voltage, all positions are open when voltage is removed. Impressive typical performance includes 0.4 dB insertion loss and isolation greater than 90 dB. This switch requires +12Vdc bias voltage and operates over a temperature range of -25°C to +65°C. The rugged and compact package assembly supports N Type female connectors and a 15 pin D-SUB connector for DC control. And for highly reliable operation, the model is guaranteed to meet MIL-STD-202 environmental test conditions for shock and random vibration.

Electrical Specifications

Switch Type	SP4T
Actuator Type	Normally Open
Switching Sequence	Break before Make

Description	Min	Typ	Max	Units
Frequency Range	DC		12	GHz
Impedance		50		Ohms
Operating Voltage	11	12	13	Volts
Actuating Current @ 12 Volts At +20°C			200	mA
VSWR		1.25:1	1.4:1	
Insertion Loss		0.3	0.5	dB
Isolation	70	90		dB
Input Power (CW)			600	Watts
Switching Time			20	ms

Performance by Frequency

Description	F1	F2	F3	F4	F5	Units
Frequency Range	DC - 1	1 - 4	4 - 8	8 - 12		GHz
VSWR, Max	1.25:1	1.3:1	1.4:1	1.4:1		
Insertion Loss, Max	0.3	0.4	0.4	0.5		dB
Isolation, Min	90	80	80	70		dB

Mechanical Specifications

Size	
Body Material and Plating	Aluminum
Package Type	Connectorized
Operating Life	2,000,000 Cycles



Features:

- Single Pole Four Throw Electromechanical Relay Switch
- DC to 12 GHz Frequency Range
- Normally Open Actuator
- 2M Lifecycle Rating
- Insertion Loss 0.3 dB typ
- Isolation > 90 dB typ
- VSWR 1.25:1 typ
- +12 Volt DC Bias
- 15 Pin D-SUB Connector for DC Control
- N Type Female Connectors
- -25°C to +65°C Operating Temperature
- Up to 600 Watt Average Power Handling
- 50 Ohm Design
- Hot Switching Capability - Consult Factory
- S-Parameter Data available upon request
- Rugged Design meets Mil-STD-202 Test Conditions

Applications:

- Aerospace & Defense
- Test & Measurement
- Microwave Radio Systems
- Military & Commercial Communication Systems
- Research & Development
- SATCOM
- Wireless Communications
- Enterprise
- IoT

Fairview Microwave
301 Leora Ln., Suite 100
Lewisville, TX 75056
Tel: 1-800-715-4396 / (972) 649-6678
Fax: (972) 649-6689
www.fairviewmicrowave.com
sales@fairviewmicrowave.com

Connectors

RF Connector Type
Control Connector

N Female
Solder Terminals

Environmental Specifications

Temperature

Operating Range
Storage Range

-25 to +65 deg C
-55 to +100 deg C

Humidity
Shock
Vibration

Moisture Resistance
MIL-STD-202 Method 213, Cond. D 500G Non Operating
MIL-STD-202 Method 204, Cond. D 10G RMS Non Operating

Compliance Certifications (see [product page](#) for current document)

Plotted and Other Data

Notes:

Typical Performance Data

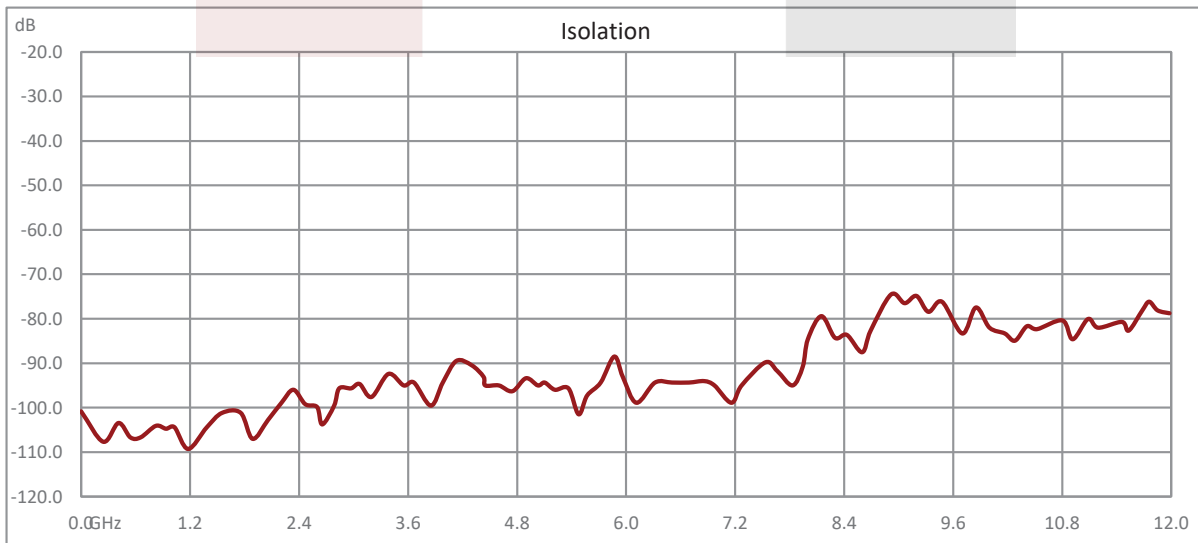
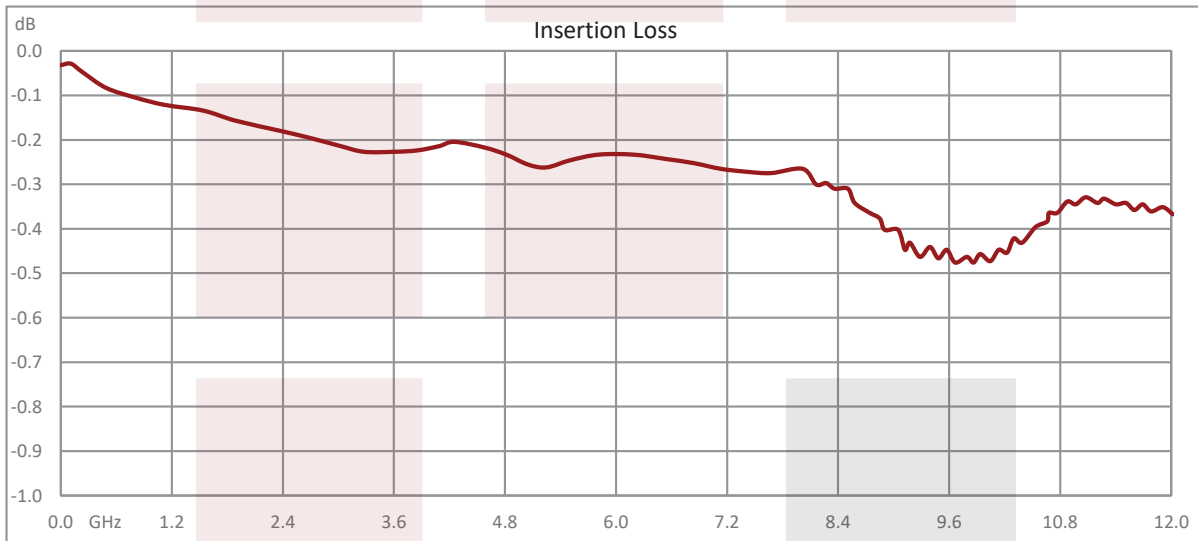

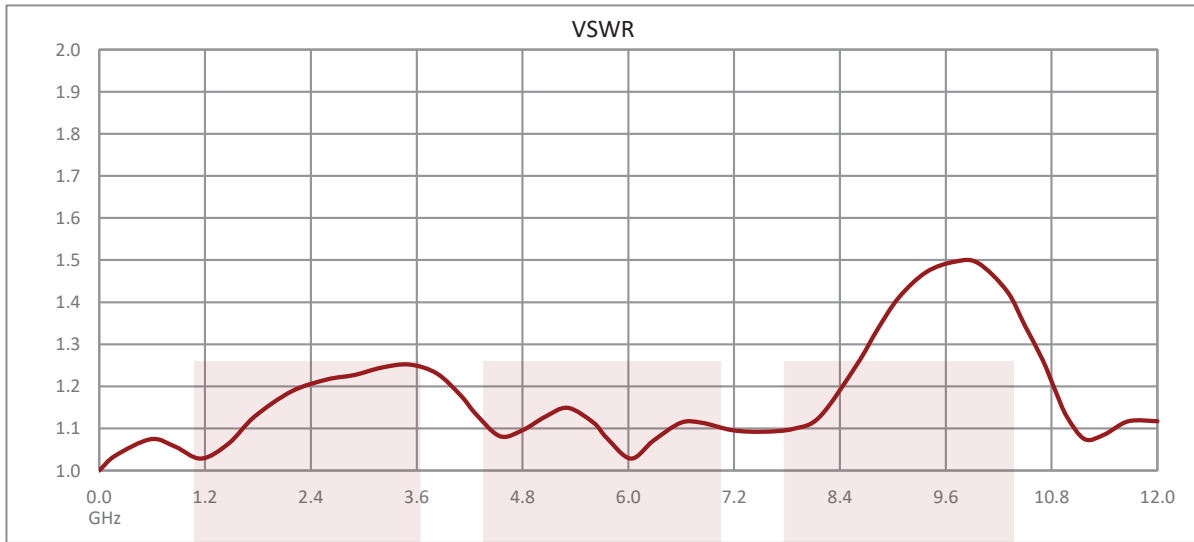

SP4T NO Electro-Mechanical Relay Switch DC to 12 GHz , Up To 600W, 12V, 2M Lifecycles, N from Fairview Microwave is in-stock and available to ship same-day. All of our RF/microwave products are available off-the-shelf from our ISO 9001:2008 certified facilities in Lewisville, Texas. Fairview Microwave is RF on-demand.

For additional information on this product, please click the following link: [SP4T NO Electro-Mechanical Relay Switch DC to 12 GHz , Up To 600W, 12V, 2M Lifecycles, N FMSW6434](#)

URL: <https://www.fairviewmicrowave.com/sp4t-failsafe-12-ghz-electro-mechanical-relay-switch-600w-12v-n-fmsw6434-p.aspx>

The information contained in this document is accurate to the best of our knowledge and representative of the part described herein. It may be necessary to make modifications to the part and/or the documentation of the part, in order to implement improvements. Fairview Microwave reserves the right to make such changes as required. Unless otherwise stated, all specifications are nominal. Fairview Microwave does not make any representation or warranty regarding the suitability of the part described herein for any particular purpose, and Fairview Microwave does not assume any liability arising out of the use of any part or documentation.

REVISIONS			
REV.	DESCRIPTION	DATE	APPROVED
A	INITIAL RELEASE	10/13/2020	T.GALLA

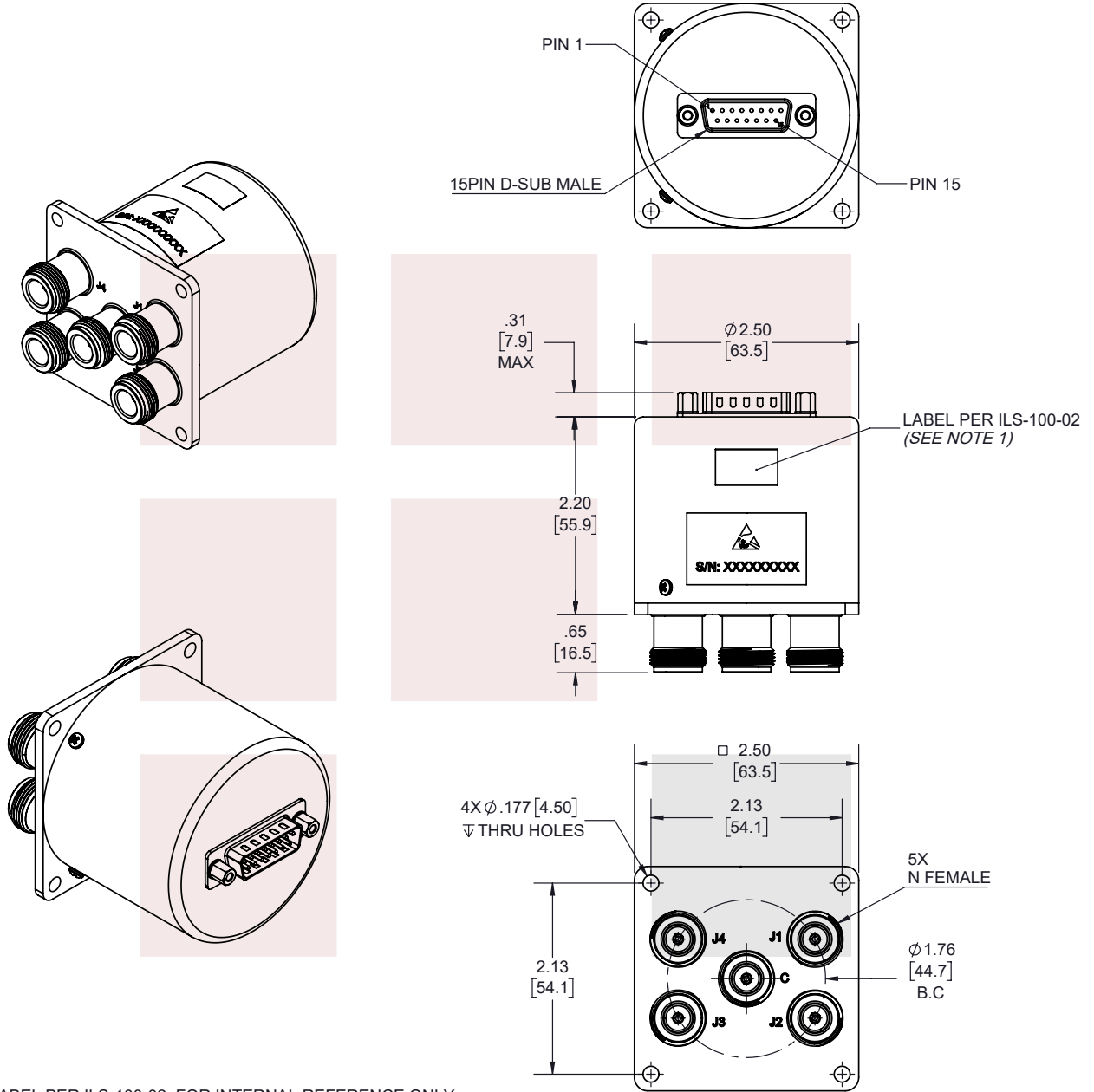

NOTES:

1. LABEL PER ILS-100-02. FOR INTERNAL REFERENCE ONLY. LABEL LOCATION FOR REFERENCE ONLY.

THESE COMMODITIES, TECHNOLOGY OR SOFTWARE WERE EXPORTED FROM THE UNITED STATES IN ACCORDANCE WITH THE EXPORT ADMINISTRATION REGULATIONS. DIVERSION CONTRARY TO U.S. LAW PROHIBITED.



TITLE
SP4T NO Electro-Mechanical Relay Switch DC to 12 GHz , Up To 600W, 12V, 2M Lifecycles, N

UNLESS OTHERWISE SPECIFIED LEADING DIMENSIONS ARE INCHES
DIMENSIONS IN [] ARE MILLIMETERS

TOLERANCES: CABLE LENGTH (L) TOLERANCES:

.X = ±.2 [5.08]	FRACTIONS	L ≤ 12 [305] = +1 [25] / -0
.XX = ±.02 [.51]	± 1/32	12 [305] < L ≤ 60 [1524] = +2 [51] / -0
.XXX = ±.005 [.13]	ANGLES ± 1°	60 [1524] < L ≤ 120 [3048] = +4 [102] / -0
		120 [3048] < L ≤ 300 [7620] = +6 [152] / -0
		300 [7620] < L = +5%L / -0

THIRD-ANGLE PROJECTION

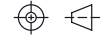

THE INFORMATION AND DESIGN IN THIS DOCUMENT IS THE PROPERTY OF FAIRVIEW MICROWAVE CORPORATION. ALL RIGHTS RESERVED.

SHEET 1 OF 2

ALL DIMENSIONS SHOWN ARE FOR REFERENCE ONLY.

SCALE N/A

SIZE A	CAGE CODE 3FKR5	DRAWN BY K.DANG	ITEM NO. FMSW6434	REV A
-----------	--------------------	--------------------	----------------------	----------

T-Rev.D

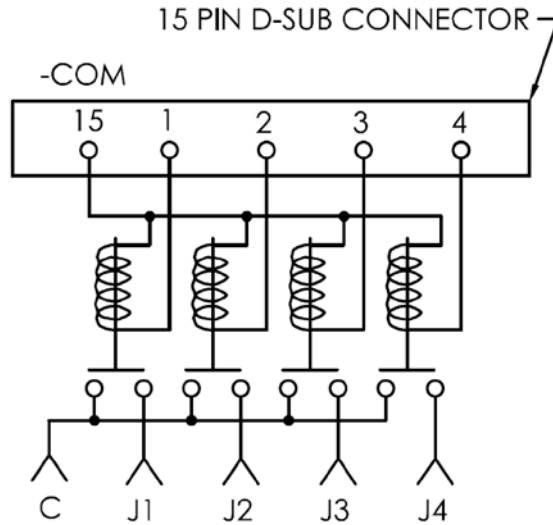

RF POSITION
SCHEMATIC

PIN ASSIGNMENT

TERMINALS D-SUB PIN ASSIGNMENT	RF PATH			
	J1	J2	J3	J4
1	ON	OFF	OFF	OFF
2	OFF	ON	OFF	OFF
3	OFF	OFF	ON	OFF
4	OFF	OFF	OFF	ON

PIN 15. -COM

THESE COMMODITIES, TECHNOLOGY OR SOFTWARE WERE EXPORTED FROM THE UNITED STATES IN ACCORDANCE WITH THE EXPORT ADMINISTRATION REGULATIONS. DIVERSION CONTRARY TO U.S. LAW PROHIBITED.

TITLE
SP4T NO Electro-Mechanical Relay Switch DC to 12 GHz , Up To 600W, 12V, 2M Lifecycles, N

UNLESS OTHERWISE SPECIFIED LEADING DIMENSIONS ARE INCHES
DIMENSIONS IN [] ARE MILLIMETERS

TOLERANCES: CABLE LENGTH (L) TOLERANCES:

.X = ±.2 [.508] FRACTIONS L ≤ 12 [305] = +1 [25] / -0
.XX = ±.02 [.51] ± 1/32 12 [305] < L ≤ 60 [1524] = +2 [51] / -0
.XXX = ±.005 [.13] ANGLES ± 1° 60 [1524] < L ≤ 120 [3048] = +4 [102] / -0
120 [3048] < L ≤ 300 [7620] = +6 [152] / -0
300 [7620] < L = +5%L / -0

THIRD-ANGLE PROJECTION

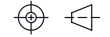

THE INFORMATION AND DESIGN IN THIS DOCUMENT IS THE PROPERTY OF FAIRVIEW MICROWAVE CORPORATION. ALL RIGHTS RESERVED.

SHEET 2 OF 2

ALL DIMENSIONS SHOWN ARE FOR REFERENCE ONLY.

SCALE N/A

SIZE A	CAGE CODE 3FKR5	DRAWN BY K.DANG	ITEM NO. FMSW6434	REV A
-----------	--------------------	--------------------	----------------------	----------

T-Rev.D