

## Q4CT Features

The Sure Cross® wireless system is a radio frequency network with integrated I/O that operates in most environments to eliminate the need for wiring runs. The Wireless Q45CT Current Transformer Node combines a pre-wired one-meter twisted pair cable for use with a supplied current transformer with the reliable, field-proven Sure Cross wireless architecture into one, easy-to-deploy package.

This proven wireless solution makes condition monitoring simple by measuring vibration and current with a single device. All configuration is done using the internal DIP switches or customized with Banner's DX80 User Configuration Software.



**Benefits**

- Deliver factory automation and IIoT solutions for a range of applications requiring vibration and current monitoring including:
  - Motor brushes
  - Motor windings
  - Motor load
  - Compressor failure
  - Energy use
  - Remote lighting use
  - On/off state
- **Eliminate control wires**—The Sure Cross wireless system is a radio frequency network with integrated I/O and an internal battery that removes the need for power and control wires
- **Reduce complexity**—Machine or process reconfiguration made easier; great for retrofit applications
- **Deploy easily**—Simplify installation on existing equipment to enable deployment in remote and hard-to-access locations where implementing a wired solution would be difficult, impractical, or not cost-effective

- The current transformer input takes a high voltage current input and produces a proportional low voltage, low current signal for measuring and monitoring.
- Selectable transmit power levels of 250 mW or 1 Watt for 900 MHz models and 65 mW for 2.4 GHz models
- DIP switches for user configuration
- Frequency Hopping Spread Spectrum (FHSS) technology ensures reliable data delivery
- Transceivers provide bidirectional communication between the Gateway and Node, including fully acknowledged data transmission
- Diagnostics allow user-defined output settings in the unlikely event of lost radio signal

## Q45CT Models

Model	Frequency	Inputs and Outputs
DX80N9Q45CT	900 MHz ISM Band	Pre-wired one-meter twisted pair cable reports true RMS Current (20 A and 150 A current transformers included with Node; model and frequency are DIP switch selectable)
DX80N2Q45CT	2.4 GHz	

To order the models without a battery, add **NB** to the model number. For example, **DX80N9Q45CT NB**.

## Storage Mode

While in **storage mode**, the device's radio does not operate to conserve the battery. To put any device into storage mode, press and hold the binding button for five seconds. The device is in storage mode when the LEDs stop blinking. To wake the device, press and hold the binding button (inside the housing on the radio board) for five seconds.

## Configuration Instructions

### Button and LEDs

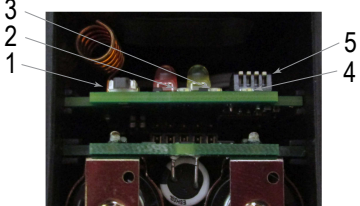

1. Binding button
2. Red LED (flashing) indicates a radio link error with the Gateway.
3. Green LED (flashing) indicates a good radio link with the Gateway.
4. Amber LED is not used.
5. DIP switches

## DIP Switches

After making any changes to any DIP switch position, reboot the Q45 by triple-clicking the binding button, waiting a second, then double-clicking the binding button.

The DIP switches are in the OFF position, by default. To turn a DIP switch on, push the switch toward the battery pack.

*DIP switches for the Q45CT*

Description	DIP Switches							
	1	2	3	4	5	6	7	8
900 MHz transmit power level: 1 Watt (30 dBm)	OFF*							
900 MHz transmit power level: 250 mW (24 dBm), DX80 compatibility mode	ON							
Mains frequency (for CT) 60 Hz		OFF*						
Mains frequency (for CT) 50 Hz		ON						
AC current transformer is 20 A model			OFF*					
AC current transformer is 150 A model			ON					
Reserved				OFF*				
Reserved					OFF*			
Sample/report rate Modbus or software configured						OFF*	OFF*	OFF*
Sample/report rate of 15 minutes						OFF	OFF	ON
Sample/report rate of 5 minutes						OFF	ON	OFF
Sample/report rate of 64 seconds						OFF	ON	ON
Sample/report rate of 32 seconds**						ON	OFF	OFF
Sample/report rate of 16 seconds**						ON	OFF	ON
Sample/report rate of 4 seconds**						ON	ON	OFF
Modbus or software configured (overrides DIP switches)						ON	ON	ON

Refer to the [Configuring for Sample on Demand](#) technical note for details on sampling on demand and using a host system.

## Transmit Power Levels

The 900 MHz radios transmit at 1 Watt (30 dBm) or 250 mW (24 dBm). The 250 mW mode reduces the radio's range but improves the battery life in short-range applications. For 2.4 GHz models, this DIP switch is disabled. The transmit power for 2.4 GHz is fixed at about 65 mW EIRP (18 dBm).

## Sample and Report Rates

The sample interval, or rate, defines how often the Sure Cross device samples the input. For battery-powered applications, setting a slower rate extends the battery life.

The report rate defines how often the Node communicates the I/O status to the Gateway. For battery-powered applications, setting the report rate to a slower rate extends the battery life.

## What is Sampling on Demand?

Sample on demand allows a host system to send a Modbus command to a register and require the inputs to immediately sample the sensor and report readings back to the host system and/or Gateway. Sampling on demand can be used between the normal periodic reporting.

The sample-on-demand feature requires using a host-controlled system capable of sending Modbus commands to the client radio.

## Sample an Input Using a Host System

To sample the input, have the Host System write to the Node's register 15. To calculate which register this is for your Node, use this equation:  $15 + (\text{Node \#} \times 16)$ .

1. From the host system, write 0x13xx to the Node's register 15, where xx defines the input you want to sample.

For Input	Write Value (in hex)	Write Value (in decimal)
1	0x1301	4865
2	0x1302	4866
3	0x1304	4868

Continued on page 3

Continued from page 2

For Input	Write Value (in hex)	Write Value (in decimal)
4	0x1308	4872
5	0x1310	4880
6	0x1320	4896
All Inputs	0x133F	4927

2. To send the Sample on Demand command to more than one input, add together the binary representation values.  
For example, to demand a sampling of inputs 1, 2, and 3, the Hex command is 0x1307.

## Wire the Current Transformer

For more information on wiring and installing the current transformer, refer to the Split Core Current Transformer datasheet (p/n [212463](#)).

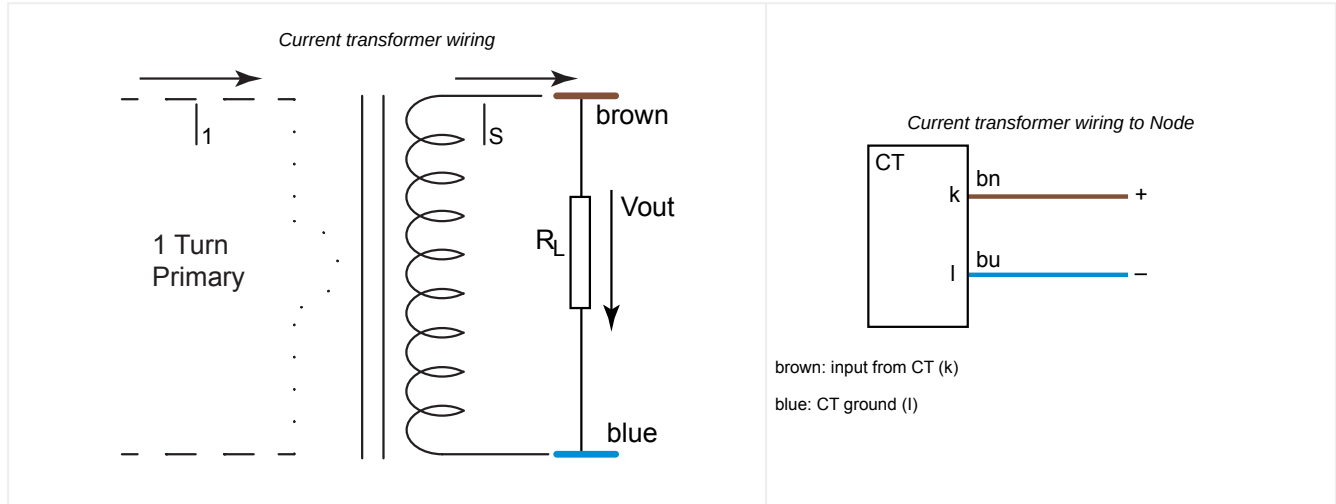

## Apply Power to the Q45 AA-Cell Models

Follow these instructions to install or replace the lithium "AA" cell batteries.

### CAUTION:



- **As with all batteries, these are fire, explosion, and severe burn hazards. There is a risk of explosion if the battery is replaced incorrectly.**
- Do not burn or expose them to high temperatures. Do not recharge, crush, disassemble, or expose the contents to water.
- Verify the battery's positive and negative terminals align to the positive and negative terminals of the battery holder mounted within the case.
- Properly dispose of used batteries according to local regulations by taking them to a hazardous waste collection site, an e-waste disposal center, or another facility qualified to accept lithium batteries.

Q45 battery board

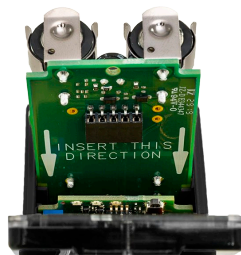

1. Loosen the clamp plate with a small Phillips screwdriver and lift the cover.
2. Slide the battery board out of the Q45 housing.
3. If applicable, remove the discharged batteries.
4. Install the new batteries.

Use Banner's **BWA-BATT-006** replacement batteries or equivalent 3.6 V AA lithium batteries, such as Xeno's XL-60F.

5. Verify the battery's positive and negative terminals align to the positive and negative terminals of the battery holder mounted within the case.
6. Slide the board containing the new batteries back into the Q45 housing.
7. Close the cover and gently tighten the clamp plate with the small Phillips screwdriver.

## Bind to the Gateway and Assign the Node Address

Before beginning the binding procedure, apply power to all the devices. Separate the devices by two meters when running the binding procedure. Put only one Gateway into binding at a time to prevent binding to the wrong Gateway.

1. On the Gateway: Enter binding mode.
  - For housed DX80 Gateways, triple-click button 2 on the Gateway. Both LEDs flash red.
  - For Gateway board modules, triple-click the button. The green and red LED flashes.
2. Assign the Q45CT a Node address using the Gateway's rotary dials. Use the left rotary dial for the left digit and the right rotary dial for the right digit. For example, to assign your Q45CT to Node 10, set the Gateway's left dial to 1 and the right dial to 0. Valid Node addresses are 01 through 47.
3. On the Q45: Loosen the clamp plate on the top of the Q45CT and lift the cover.
4. Enter binding mode on the Q45CT by triple-clicking the Q45CT's button. The red and green LEDs flash alternately and the sensor searches for a Gateway in binding mode. After the Q45CT is bound, the LEDs stay solid momentarily, then they flash together four times. The Q45CT exits binding mode.
5. Label the sensor with the Q45CT's Node address number for future reference.
6. Repeat steps 2 through 5 for as many Q45CTs as are needed for your network.
7. On the Gateway: After binding all Q45CTs, exit binding mode.
  - For housed DX80 Gateways, double-click button 2.
  - For board-level DX80 Gateways, double-click the button.

For Gateways with single-line LCDs: After binding your Q45CT to the Gateway, make note of the binding code displayed under the Gateway's \*DVCFG menu, XADR submenu on the LCD. Knowing the binding code prevents having to re-bind all Q45CTs if your Gateway is ever replaced.

## Bind to a DXM and Assign the Node Address

Before beginning the binding procedure, apply power to all the devices. Separate the radios by two meters when running the binding procedure. Put only one DXM into binding mode at a time to prevent the Q45CT from binding to the wrong Gateway.

1. On the DXM: Use the arrow keys to select the **ISM Radio** menu on the LCD and click **ENTER**.
2. Highlight the **Binding** menu and click **ENTER**.
3. Use the arrow keys to select the Node address to bind the Q45CT to.
4. On the Q45CT: Loosen the top clamp plate and lift the cover.
5. Enter binding mode by triple-clicking the binding button. The red and green LEDs flash alternately and the sensor searches for a Gateway in binding mode. After the Node binds, the LEDs stay solid momentarily, then they flash together four times. The Node exits binding mode.
6. Label the sensor with the Node address number for future reference.
7. On the DXM: Click **BACK** to exit binding for that specific Node address.
8. Repeat steps 3 through 7 and change the Node address for as many Q45CTs as are needed for your network.
9. On the DXM: After you have finished forming your network, click **BACK** until you reach the main menu.

## Q45CT Holding Registers

*Holding registers for the Q45CT Sensor Node*

Modbus Registers		EIP Registers		I/O Type	I/O Range		Holding Register Representation (Dec)	
Gateway	Node	Node			Min.	Max.	Min.	Max.
1	1 + (Node# × 16)	0 + (Node# × 8)	Instance 100 / N7	Current Transformer Input Register				
...	...	...						
7	7 + (Node# × 16)	6 + (Node# × 8)		Reserved				
8	8 + (Node# × 16)	7 + (Node# × 8)		Device Message				
	...							
15	15 + (Node# × 16)	6 + (Node# × 8)	Instance 112 / N14	Control Message				
16	16 + (Node# × 16)	7 + (Node# × 8)		Reserved				

To interpret the holding register representation of the current transformer (CT) in amperes, divide the register value by 100.

To use a current transformer other than those provided, ensure the CT matches the 333 mV output characteristics of the CTs provided with the Condition Monitoring Node. For more information, see "[Specifications](#)" on page 5.

If the custom CT exceeds the 150 A CT, set DIP switch 3 to ON and use a DXM Controller or PLC to multiply the typical 150 A output value in the input by the ratio of the custom CT to 150 A. For example: For a 300 A CT, divide the register data by 100 as you would for the 150 A CT, then multiply that value by 2 to scale it to 300 A.

## Specifications

### Radio Specifications for Performance with Internal Antenna

#### Supplied Antenna

This device includes an internal 2 dB antenna. Range depends on the environment and decreases significantly without line-of-sight. Always verify your wireless network's range by performing a Site Survey.

#### Radio Transmit Power (900 MHz, 1 Watt radios)

Conducted: 30 dBm (1 W)  
EIRP with the supplied 2 dB antenna: < 36 dBm

#### Radio Transmit Power (2.4 GHz radios)

Conducted: < 18 dBm (65 mW)  
EIRP with the supplied 2 dB antenna: < 20 dBm (100 mW)

#### Antenna Minimum Separation Distance

900 MHz (1 Watt): 4.57 m (15 ft) with the supplied 2 dB antenna  
2.4 GHz (65 mW): 0.3 m (1 ft) with the supplied 2 dB antenna

#### Radio Range

900 MHz (in 1 Watt mode): Up to 3.2 km (2 miles) with line of sight (internal antenna)  
2.4 GHz: Up to 1000 m (3280 ft) with line of sight (internal antenna)

#### Link Timeout (Performance)

Gateway: Configurable via User Configuration Software  
Node: Defined by Gateway

#### Spread Spectrum Technology

FHSS (Frequency Hopping Spread Spectrum)

#### 900 MHz Compliance (SX7023EXT Radio Module)

Radio module is indicated by the product label marking  
Contains FCC ID: UE3SX7023EXT: FCC Part 15, Subpart C, 15.247  
Contains IC: 7044A-SX7023EXT

#### 900 MHz Compliance (RM1809 Radio Module)

Radio module is indicated by the product label marking  
Contains FCC ID: UE3RM1809: FCC Part 15, Subpart C, 15.247  
Contains IC: 7044A-RM1809  
IFT: RCPBARM13-2283



#### 2.4 GHz Compliance (DX80-2400 Radio Module)

Radio module is indicated by the product label marking  
Contains FCC ID: UE300DX80-2400: FCC Part 15, Subpart C, 15.247  
Radio Equipment Directive (RED) 2014/53/EU  
Contains IC: 7044A-DX8024  
ANATEL: 15966-21-04042



#### 2.4 GHz Compliance (SX243 Radio Module)

Radio module is indicated by the product label marking  
Contains FCC ID: UE3SX243: FCC Part 15, Subpart C, 15.247  
Radio Equipment Directive (RED) 2014/53/EU  
ETSI/EN: EN 300 328 V2.2.2 (2019-07) [RED HarmStds]  
Contains IC: 7044A-SX243  
ANATEL: 03737-22-04042



## Q45CT Specifications

#### Supply Voltage

3.6 V DC (internal battery)

#### Current Draw at 3.6 V DC

900 MHz, 1 Watt: Approximately 1 mA  
900 MHz, 250 mW: Approximately 0.5 mA  
2.4 GHz, 65 mW: Approximately 0.3 mA

#### CT20A and CT150A Current Transformer

Electrical:  
Rated input: 0–20 A (CT20A) or 0–150 A (CT150A)  
Rated Output: 0.333 V (AC)  
Ratio:  $\leq \pm 1.0\%$   
Phase angle:  $\leq \pm 60$  min  
Dielectric Strength: 2.5 kV/1 mA/1 min  
Insulation Resistance: DC500 V/100 MOhm min

#### Mechanical:

Case: PA / UL94-V0  
Bobbin: PBT  
Core: Silicon Steel  
–25 °C to +75 °C (–13 °F to +167 °F)  
 $\leq 85\%$  maximum relative humidity (non-condensing)

For more information, refer to the [Split Core Current Transformer](#) datasheet (p/n 212463)

#### Indicators

Red and green LEDs (radio function)

#### Typical Battery Life

See chart

#### Default Sensing Interval

5 minutes

#### Construction

Molded reinforced thermoplastic polyester housing, oring-sealed transparent Lexan® cover, molded acrylic lenses, and stainless steel hardware. Designed to withstand 1200 psi washdown.

**Certifications**



Banner Engineering BV  
Park Lane, Culliganlaan 2F bus 3  
1831 Diegem, BELGIUM



Turck Banner LTD Blenheim House  
Blenheim Court  
Wickford, Essex SS11 8YT  
GREAT BRITAIN

(CE/UKCA approval only applies to 2.4 GHz models)

## Environmental Specifications for the Q45

**Operating Conditions**

-40 °C to +70 °C (-40 °F to +158 °F); 90% at +50 °C  
maximum relative humidity (non-condensing)  
Radiated Immunity: 10 V/m (EN 61000-4-3)

**Environmental Rating**

NEMA 6P  
IP67

Operating the devices at the maximum operating conditions for extended periods can shorten the life of the device.

## Battery Life for the Q45DT Node

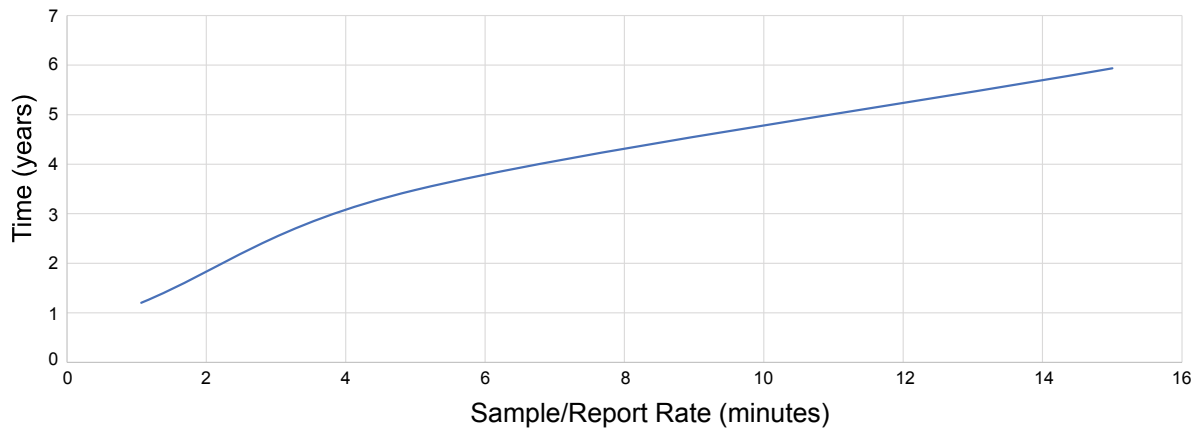

## FCC Part 15 Class A for Intentional Radiators

This equipment has been tested and found to comply with the limits for a Class A digital device, pursuant to part 15 of the FCC Rules. These limits are designed to provide reasonable protection against harmful interference when the equipment is operated in a commercial environment. This equipment generates, uses, and can radiate radio frequency energy and, if not installed and used in accordance with the instruction manual, may cause harmful interference to radio communications. Operation of this equipment in a residential area is likely to cause harmful interference in which case the user will be required to correct the interference at his own expense.

## Industry Canada Statement for Intentional Radiators

This device contains licence-exempt transmitters(s)/receiver(s) that comply with Innovation, Science and Economic Development Canada's licence-exempt RSS(s). Operation is subject to the following two conditions:

1. This device may not cause interference.
2. This device must accept any interference, including interference that may cause undesired operation of the device.

Cet appareil contient des émetteurs/récepteurs exemptés de licence conformes à la norme Innovation, Sciences, et Développement économique Canada. L'exploitation est autorisée aux deux conditions suivantes:

1. L'appareil ne doit pas produire de brouillage.
2. L'utilisateur de l'appareil doit accepter tout brouillage radioélectrique subi, même si le brouillage est susceptible d'en compromettre le fonctionnement.

## Q45CT Accessories

### BWA-CURRENT-TRANSFORMER-20A Split-Core Current Transformer

- 5–20 A Input
- 0.333 V Output
- Datasheet p/n [212463](#)

A = 41 mm; B = 24 mm; C = 26.5 mm

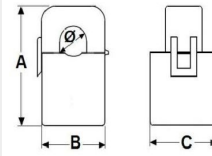

### BWA-CURRENT-TRANSFORMER-150A Split-Core Current Transformer

- 5–150 A Input
- 0.333 V Output
- Datasheet p/n [212463](#)

A = 45.5 mm; B = 29 mm; C = 31.5 mm

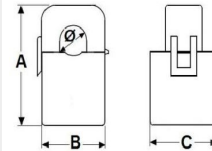

### BWA-BATT-006

- 3.6 V Lithium AA cell
- Two batteries



## Warnings

### WARNING:



- **Do not use this device for personnel protection**
- Using this device for personnel protection could result in serious injury or death.
- This device does not include the self-checking redundant circuitry necessary to allow its use in personnel safety applications. A device failure or malfunction can cause either an energized (on) or de-energized (off) output condition.

**IMPORTANT:** Please download the complete Wireless Q45CT Current Transformer Node technical documentation, available in multiple languages, from [www.bannerengineering.com](http://www.bannerengineering.com) for details on the proper use, applications, Warnings, and installation instructions of this device.

**IMPORTANT:** Por favor descargue desde [www.bannerengineering.com](http://www.bannerengineering.com) toda la documentación técnica de los Wireless Q45CT Current Transformer Node, disponibles en múltiples idiomas, para detalles del uso adecuado, aplicaciones, advertencias, y las instrucciones de instalación de estos dispositivos.

**IMPORTANT:** Veuillez télécharger la documentation technique complète des Wireless Q45CT Current Transformer Node sur notre site [www.bannerengineering.com](http://www.bannerengineering.com) pour les détails sur leur utilisation correcte, les applications, les notes de sécurité et les instructions de montage.

**Install and properly ground a qualified surge suppressor when installing a remote antenna system.** Remote antenna configurations installed without surge suppressors invalidate the manufacturer's warranty. Keep the ground wire as short as possible and make all ground connections to a single-point ground system to ensure no ground loops are created. No surge suppressor can absorb all lightning strikes; do not touch the Sure Cross® device or any equipment connected to the Sure Cross® device during a thunderstorm.

**Exporting Sure Cross® Radios.** It is our intent to fully comply with all national and regional regulations regarding radio frequency emissions. **Customers who want to re-export this product to a country other than that to which it was sold must ensure the device is approved in the destination country.** The Sure Cross wireless products were certified for use in these countries using the antenna that ships with the product. When using other antennas, verify you are not exceeding the transmit power levels allowed by local governing agencies. This device has been designed to operate with the antennas listed on Banner Engineering's website and having a maximum gain of 9 dBm. Antennas not included in this list or having a gain greater than 9 dBm are strictly prohibited for use with this device. The required antenna impedance is 50 ohms. To reduce potential radio interference to other users, the antenna type and its gain should be so chosen such that the equivalent isotropically radiated power (EIRP) is not more than that permitted for successful communication. Consult with Banner Engineering Corp. if the destination country is not on this list.



**IMPORTANT:**

- **Never operate a 1 Watt radio without connecting an antenna**
- Operating 1 Watt radios without an antenna connected will damage the radio circuitry.
- To avoid damaging the radio circuitry, never apply power to a Sure Cross® Performance or Sure Cross MultiHop (1 Watt) radio without an antenna connected.

**IMPORTANT:**

- **Electrostatic discharge (ESD) sensitive device**
- ESD can damage the device. Damage from inappropriate handling is not covered by warranty.
- Use proper handling procedures to prevent ESD damage. Proper handling procedures include leaving devices in their anti-static packaging until ready for use; wearing anti-static wrist straps; and assembling units on a grounded, static-dissipative surface.

## Banner Engineering Corp Limited Warranty

Banner Engineering Corp. warrants its products to be free from defects in material and workmanship for one year following the date of shipment. Banner Engineering Corp. will repair or replace, free of charge, any product of its manufacture which, at the time it is returned to the factory, is found to have been defective during the warranty period. This warranty does not cover damage or liability for misuse, abuse, or the improper application or installation of the Banner product.

**THIS LIMITED WARRANTY IS EXCLUSIVE AND IN LIEU OF ALL OTHER WARRANTIES WHETHER EXPRESS OR IMPLIED (INCLUDING, WITHOUT LIMITATION, ANY WARRANTY OF MERCHANTABILITY OR FITNESS FOR A PARTICULAR PURPOSE), AND WHETHER ARISING UNDER COURSE OF PERFORMANCE, COURSE OF DEALING OR TRADE USAGE.**

This Warranty is exclusive and limited to repair or, at the discretion of Banner Engineering Corp., replacement. **IN NO EVENT SHALL BANNER ENGINEERING CORP. BE LIABLE TO BUYER OR ANY OTHER PERSON OR ENTITY FOR ANY EXTRA COSTS, EXPENSES, LOSSES, LOSS OF PROFITS, OR ANY INCIDENTAL, CONSEQUENTIAL OR SPECIAL DAMAGES RESULTING FROM ANY PRODUCT DEFECT OR FROM THE USE OR INABILITY TO USE THE PRODUCT, WHETHER ARISING IN CONTRACT OR WARRANTY, STATUTE, TORT, STRICT LIABILITY, NEGLIGENCE, OR OTHERWISE.**

Banner Engineering Corp. reserves the right to change, modify or improve the design of the product without assuming any obligations or liabilities relating to any product previously manufactured by Banner Engineering Corp. Any misuse, abuse, or improper application or installation of this product or use of the product for personal protection applications when the product is identified as not intended for such purposes will void the product warranty. Any modifications to this product without prior express approval by Banner Engineering Corp will void the product warranties. All specifications published in this document are subject to change; Banner reserves the right to modify product specifications or update documentation at any time. Specifications and product information in English supersede that which is provided in any other language. For the most recent version of any documentation, refer to: [www.bannerengineering.com](http://www.bannerengineering.com).

For patent information, see [www.bannerengineering.com/patents](http://www.bannerengineering.com/patents).

## Notas Adicionales

Información México: La operación de este equipo está sujeta a las siguientes dos condiciones: 1) es posible que este equipo o dispositivo no cause interferencia perjudicial y 2) este equipo debe aceptar cualquier interferencia, incluyendo la que pueda causar su operación no deseada.

Banner es una marca registrada de Banner Engineering Corp. y podrán ser utilizadas de manera indistinta para referirse al fabricante. "Este equipo ha sido diseñado para operar con las antenas tipo Omnidireccional para una ganancia máxima de antena de 6 dBd y Yagi para una ganancia máxima de antena 10 dBd que en seguida se enlistan. También se incluyen aquellas con aprobación ATEX tipo Omnidireccional siempre que no excedan una ganancia máxima de antena de 6dBd. El uso con este equipo de antenas no incluidas en esta lista o que tengan una ganancia mayor que 6 dBd en tipo omnidireccional y 10 dBd en tipo Yagi, quedan prohibidas. La impedancia requerida de la antena es de 50 ohms."

## Mexican Importer

Banner Engineering de México, S. de R.L. de C.V. | David Alfaro Siqueiros 103 Piso 2 Valle oriente | San Pedro Garza Garcia Nuevo León, C. P. 66269

81 8363.2714

Document title: Sure Cross® Q45CT Wireless Current Monitoring Node  
Part number: 221079  
Revision: D  
Original Instructions  
© Banner Engineering Corp. All rights reserved.

