



Minty Boost

Created by lady ada



<https://learn.adafruit.com/minty-boost>

Last updated on 2023-08-29 02:18:01 PM EDT

Table of Contents

Overview 5

- [Minty Boost: Portable USB power](#)
- [A small battery-powered USB charger](#)
- [Overview](#)
- [Reviews & Gallery](#)
- [Device Compatibility](#)

F.A.Q. 8

- [Frequently Asked Questions](#)
- [It works! But then the iPod/iPhone/device gets drained...what's up?](#)
- [How come my iPhone/iTouch doesn't completely charge?](#)
- [Will the MintyBoost charge my device?](#)
- [ARRGH! It doesn't work!](#)
- [I get the right voltages but it doesn't charge my favorite gadget! Is the kit a "USB Specification" Charger? If not, how can I make it into one?](#)
- [Can I buy a pre-made/pre-built MintyBoost?](#)
- [What does the MintyBoost kit come with?](#)
- [How many charges/hours of use can I get out of a MintyBoost?](#)
- [I want better performance, should I attach 3 or 4 AA batteries? How about a 9V?](#)
- [OK but what if I want 4 AA's, 2 sets of 2 in parallel?](#)
- [When I use the kit, the chip/batteries seems warm or hot...Is this OK?](#)
- [But it's really hot and I'm worried!](#)
- [When I plug in a device, sometimes theres a 'hum', 'hiss', 'squeak', 'whine', etc noise...is this normal?](#)
- [If this is a charger, why are the data \(D+ and D-\) lines used? Why doesn't the 3Gs work with the Mintyboost v2, but the older iPhone does? What are the pullup/down resistors used for, and which should I use?](#)
- [Does the v1.x work with iPhone/iTouch? Does the v2.0?](#)
- [Can I convert a v1.x kit to a v2.x? Can I use a MAX756 in a v2.x or a LT1302-5 in a v1.x?](#)
- [Why doesn't the v1.2 kit come with R1-R3 and LED1](#)
- [I'm trying to make/breadboard this kit on my own and it's not working! HELP ME!](#)
- [Do you have any high rez photos?](#)

Make it! 12

- [Make your own](#)
- [Make it!](#)
- [Older soldering instructions!](#)

Preparation 13

- [Tools](#)

Parts list 16

- [Check your kit!](#)
- [Parts list for v3.0](#)
- [Schematic for v3.0](#)
- [Parts list for v2.0](#)
- [Schematic for v2.0](#)
- [Parts list for v1.2](#)
- [Schematic for v1.2](#)

Solder it 33

- [Instructions for Version 3.0](#)
- [Solder It!](#)

Case it	54
<hr/>	
Use it!	60
<hr/>	
<ul style="list-style-type: none">• Tips and tricks, how to use your MintyBoost• The MintyBoost User manual!	
How to use	60
<hr/>	
<ul style="list-style-type: none">• Basic User Manual• Go MintyBoost!• Compatibility• Which batteries to use?• How to charge• While charging...• When to stop charging	
Batteries	62
<hr/>	
<ul style="list-style-type: none">• User manual - Choosing batteries• Batteries?• How the mintyboost works• Standard AA's• Rechargeable AAs• Alkaline or rechargeable?• Bigger batteries? More batteries?• Lithium Ion Polymer• How many recharges will I get?• Detailed guidelines - Voltage Requirements• Detailed guidelines - Current Requirements• Tons of info!	
Compat v3	69
<hr/>	
<ul style="list-style-type: none">• Device Compatibility list for v3• Verison 3 mintyboosts!• Apple Products• HTC• LG• Motorola• Samsung• Sony Ericsson• Nokia• RIM• More Phones!• eBook Readers• Handheld Games• MP3 Player	
Compat v2	75
<hr/>	
<ul style="list-style-type: none">• Device Compatibility for v2.x Mintyboosts• For version 2.x only!• Mintyboost Compatibility chart!	
Process	77
<hr/>	
<ul style="list-style-type: none">• How to: How to• Meta Documentation• Original Idea• Engineering better!	

- Case in point
- Basic Boost
- Inductive reasoning
- Rapid prototyping #1
- Testing the prototype
- Verifying the math
- Kit budgeting
- Finishing up

iCharging

103

-
- The mysteries of Apple device charging
 - The Video
 - Quick introduction to USB
 - Using USB as a power supply
 - iCharge!
 - First attempt
 - The iPhone and larger iPods
 - iPhones

Change Log

112

-
- What's changed?
 - A long history of boosting
 - V1.0 - June 2006 (first release)
 - v1.1 - July 2006
 - v1.2 - April 2007
 - v2.0 - August 2008
 - v3.0 - August 2010

Download

114

-
- CAD Files
 - Datasheets
 - v2.0 files
 - v1.0, v1.1 and v1.2 files

Overview

Minty Boost: Portable USB power

A small battery-powered USB charger



Overview

This project details a small & simple, but very powerful USB charger for your mp3 player, camera, cell phone, and just about any other gadget you can plug into a USB

port to charge! (See below for compatibility tests.)

The charger circuitry and 2 AA batteries fit into an Altoids gum tin, and will run your iPod for hours! 2.5x more than you'd get from a 9V USB charger! (See [Process \(\)](#) for math/calculations) [You can use rechargeable batteries too \(\)](#).

Specifications:

- Version 3 now works with iPhones and newer iGadgets!
- 5V output @ 500mA output
- Fits in your pocket
- Recharges just about any gadget with a USB cable
- [Uses any AA batteries! \(\)](#)
- [Upgrade to C or D cells for a mega battery pack \(\)](#)

Some numbers...

- iPhone (all types): 3/4 full recharge
- iPod video (tested, using alkaline batteries): 3hrs more video (1 full recharge)
- iPod mini (tested w/rechargeables): 26 hours more (1.5 full recharges)
- iPod nano: 4 full recharges!
- iPod shuffle : 60 hours more , 5 full recharges!

This project is suitable for beginners, some soldering tools are necessary but even if you've never soldered before it should be pretty easy. You can etch a circuitboard and/or breadboard this up, or simply [buy a kit from the webshop \(\)](#).

I've also documented the [process of designing this kit \(\)](#), in case other people interested in designing and making kits are interested in learning how to start selling their own kits!



This project was developed under support from [EYEBEAM \(\)](#), thanks!



This website and all original content therein is published under the [Creative Commons \(\)](#) 2.5 attribution license.

Reviews & Gallery

Read what some people have to say! (And let me know if you have a review you'd like linked to from here)

- [Paul Stamatou's review \(\)](#)
- [Jim Wandering's review \(\)](#)
- [Daniel Beck's review \(\)](#)
- [The Samurai's gallery \(\)](#)
- [Erike built one for his sweetheart \(\)](#)
- [Bean tooth made a cherry flavored one \(\)](#)
- [Piet in Finland uses his for watching long videos \(\)](#)
- [Lexiredlion built 5! \(\)](#)

Device Compatibility

[Hey we moved this really long list to the user manual, please go there to see compatibility charts for versions 2 and 3 of the mintyboost! \(\)](#)

Mintyboost® is a registered trademark of Adafruit Industries

F.A.Q.

Frequently Asked Questions

It works! But then the iPod/iPhone/device gets drained...what's up?

This is a common problem with iPods/iPhone/iTouch. These devices have very large batteries and they have an annoying bug that if they -think- they're being charged they'll stay on and not 'go to sleep' conserving power. That means that if the AA batteries die before the device is done charging, the device will stay on at full power because it thinks it is plugged into the wall. This can cause it to drain the battery. The best suggestion is to use fresh/charged batteries and don't leave it plugged in overnight.

This is especially true of iPhones, as they suck out all the battery power in a little less than an hour in order to 'quick charge'. This reduces the capacity of the batteries, but means that your phone will be up and running faster.

[Once you see the charging icon change from a plug, the mintyboost is 'dead' and you must unplug it. For more information, see the user manual. \(\)](#)

How come my iPhone/iTouch doesn't completely charge?

iPhone/iTouch's have batteries that are so large there is no way to fully charge them on 2 AA's. You can only charge 1/2 of a battery because the AA's will die before finishing. You should use the Mintyboost to 'boost' it, but not as a way to fill the whole battery to full.

Will the MintyBoost charge my device?

Very likely! [Check out our compatibility lists for more information about your favvy gadget \(\)](#). If you find a new device that it does/doesn't work with, please post on the

forum or contact us (thanks!)

Nearly all USB-charging devices and any device that charges with 5V power (up to 500mA+ with v2 or v3 of the kit) can be used.

If you are having problems with your device, see the other FAQ's below.

ARRGH! It doesn't work!

Don't panic! [Post to the forum \(\)](#) (don't send email) about your problem.

A high resolution photo of the top and bottom of your kit will be extremely helpful in debugging your problem.

I get the right voltages but it doesn't charge my favorite gadget! Is the kit a "USB Specification" Charger? If not, how can I make it into one?

Some devices will only charge from 'dedicated USB spec' charger. You may want to convert your Mintyboost to a 'USB spec' charger, which is very simple to do, [follow the instructions here on how to do it \(\)](#). This mod will work on any MintyBoost version (v1 v2 or v3) Then try again!

Can I buy a pre-made/pre-built MintyBoost?

We don't sell assembled MintyBoosts, only [kits \(\)](#). However, if you post on the forum, people sometimes offer to sell manufactured kits at low cost.

What does the MintyBoost kit come with?

The kit comes with a PCB and all components necessary to build the kit. It does not come with an altoids tin or tools or batteries. The tin isn't necessary but MintyBoost is designed to be placed in one for protection and aesthetics.

How many charges/hours of use can I get out of a MintyBoost?

This question is hard to judge because every device has different power usage. However, a simple way to calculate approximate run-time is: take the size of the internal Lithium-Ion battery (for example, many iPods have 750mAh batteries) and divide 1000 by that number.

So for a 750mA battery, $1000/750 = 1.3$

The MintyBoost will fully charge the device about 1.3 times, as a best case.

Remember, this is only an approximation and has a lot to do with the quality of the batteries you use (expensive alkalines v. cheap rechargables) and the internal circuitry of the device for recharging the battery.

[For a detailed mathematical analysis, check the user manual under "How many recharges will I get?" \(\)](#)

I want better performance, should I attach 3 or 4 AA batteries? How about a 9V?

[Check out our detailed battery power tutorial! \(\)](#)

OK but what if I want 4 AA's, 2 sets of 2 in parallel?

[Check out our detailed battery power tutorial! \(\)](#)

When I use the kit, the chip/batteries seems warm or hot...Is this OK?

It's normal for the chip and batteries to be warm or hot, especially when charging a device that is nearly drained. The chip should not get hot or very warm when nothing is plugged in.

The maximum temperature for the mintyboost chip is over 100 degrees C, that is hotter than boiling water. If you are worried, lick your finger (a little) and touch the tip of your finger to the top of the LT1302 chip. If you don't hear a sizzle (of the water boiling away), it's just fine.

However, if the batteries are so hot that its painful to touch, start to smoke, burn or melt or leak fluid....something is wrong! Unplug it immediately and remove the batteries if it is safe to do so.

But it's really hot and I'm worried!

Yes, this is normal. When the chip is working to charge your gadget, it's going to get hot. Normally you never get to see or touch the chips in your chargers so you don't realize how hot electronics get.

Really, it's normal for the Mintyboost to get hot!

If you're concerned, you can always do the finger test above. If it's too hot, it will

sizzle, otherwise, it's OK.

When I plug in a device, sometimes theres a 'hum', 'hiss', 'squeak', 'whine', etc noise...is this normal?

Yes, sometimes the inductor resonates with the boost converter and that resonance leaks into the audible range. While it's not good for it to always vibrate, it does happen occasionally and is not harmful to the charging device. you can try moving the inductor a little with your finger but the noise is electrical in nature so it's hard to stop completely.

Another thing is that it depends on how much power the device is drawing and what kind of batteries are inside.

If this is a charger, why are the data (D+ and D-) lines used? Why doesn't the 3Gs work with the Mintyboost v2, but the older iPhone does? What are the pullup/down resistors used for, and which should I use?

[We have a full tutorial all about Apple gadget charging, check it out! \(\)](#)

Does the v1.x work with iPhone/iTouch? Does the v2.0?

Version 2.0 pretty much works with iPhones/iTouch devices but the v1.0 cannot because it is not powerful enough. To get it working you will need the LT1302-5 which can provide 500mA (compared to 200mA from the MAX756).

[We have a full tutorial all about Apple gadget charging, check it out! \(\)](#)

Can I convert a v1.x kit to a v2.x? Can I use a MAX756 in a v2.x or a LT1302-5 in a v1.x?

No, they are completely different designs requiring new PCBs and components, they are not drop-in replaceable at all.

Why doesn't the v1.2 kit come with R1-R3 and LED1

These parts are optional: they are for the low battery indicator. There wasn't enough space to add them to the PCB using through hole parts so they are surface mount and on the bottom. They're an 'extra' capability which you may add if you feel experienced

with SMT soldering.

I'm trying to make/breadboard this kit on my own and it's not working! HELP ME!

It is pretty much impossible to get good output from the kit if it is breadboarded. A custom PCB or proper perf-board is essential. Most components cannot be swapped, and must be used as indicated, even if they're difficult to find in your area. All documentation is on the site.

I can't provide any support or help to 'DIYer's because of the time and difficulty in debugging these projects. Please endeavor to work out your project on your own.

Do you have any high rez photos?

Try:

- ["Standard issue" iPod charging photo \(\)](#)
- [PSP \(\)](#)
- [Wave Bubble \(\)](#)
- [Shuffle 2G \(\)](#)
- [Nano 1G \(\)](#)
- [Dell Mp3 player \(\)](#)
- [Video iPod \(\)](#)
- [Photo iPod \(\)](#)

Mintyboost® is a registered trademark of Adafruit Industries

Make it!

Make your own

Make it!

This is a vey easy kit to make, just go through each of these steps to build the kit:

1. [Tools and preparation \(\)](#)
2. [Check the parts list \(\)](#)

3. [Solder it \(\)](#) (Instructions for version 3.0 kits only!)
4. [Put it in a case \(\)](#)

Older soldering instructions!

If you have an older Mintyboost (or just interested in photos of soldering), here you go!

- [Version 2.0 \(\)](#)
- [Version 1.x \(\)](#)
- [Test v2.0 or v1.x mintyboosts \(\)](#)

Mintyboost® is a registered trademark of Adafruit Industries

Preparation

[Learn how to solder with tons of tutorials! \(\)](#)

[Don't forget to learn how to use your multimeter too! \(\)](#)

Tools

There are a few tools that are required for assembly. None of these tools are included. If you don't have them, now would be a good time to borrow or purchase them. They are very very handy whenever assembling/fixing/modifying electronic devices! I provide links to buy them, but of course, you should get them wherever is most convenient/inexpensive. Many of these parts are available in a place like Radio Shack or other (higher quality) DIY electronics stores.

Soldering iron



Any entry level 'all-in-one' soldering iron that you might find at your local hardware store should work. As with most things in life, you get what you pay for.

Upgrading to a higher end soldering iron setup, like the [Hakko FX-888](http://adafru.it/180) that we stock in our store (<http://adafru.it/180>), will make soldering fun and easy.



Do not use a "ColdHeat" soldering iron!
They are not suitable for delicate electronics work and can damage the kit ([see here](#) ()).

[Click here to buy our entry level adjustable 30W 110V soldering iron \(http://adafru.it/180\)](http://adafru.it/180).

[Click here to upgrade to a Genuine Hakko FX-888 adjustable temperature soldering iron. \(http://adafru.it/303\)](http://adafru.it/303)

Solder



You will want rosin core, 60/40 solder. Good solder is a good thing. Bad solder leads to bridging and cold solder joints which can be tough to find.

[Click here to buy a spool of leaded solder \(recommended for beginners\) \(http://adafru.it/145\)](http://adafru.it/145).

[Click here to buy a spool of lead-free solder \(http://adafru.it/734\)](http://adafru.it/734).



Multimeter

You will need a good quality basic multimeter that can measure voltage and continuity.

[Click here to buy a basic multimeter. \(http://adafru.it/71\)](http://adafru.it/71)

[Click here to buy a top of the line multimeter. \(http://adafru.it/308\)](http://adafru.it/308)

[Click here to buy a pocket multimeter. \(http://adafru.it/850\)](http://adafru.it/850)





Flush Diagonal Cutters

You will need flush diagonal cutters to trim the wires and leads off of components once you have soldered them in place.

[Click here to buy our favorite cutters \(http://adafru.it/152\).](http://adafru.it/152)



Solder Sucker

Strangely enough, that's the technical term for this desoldering vacuum tool. Useful in cleaning up mistakes, every electrical engineer has one of these on their desk.

[Click here to buy a one \(http://adafru.it/148\).](http://adafru.it/148)

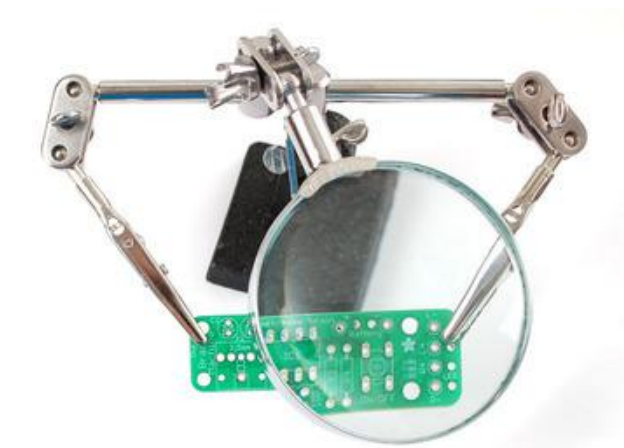

Helping Third Hand With Magnifier

Not absolutely necessary but will make things go much much faster, and it will make soldering much easier.

[Pick one up here \(http://adafru.it/291\).](http://adafru.it/291)

Parts list



Check your kit!



Check to make sure your kit comes with the following parts. Sometimes we make mistakes so double check everything and email support@adafruit.com if you need replacements!



Note that the parts list is slightly different depending on whether it is the latest v3.0 kit, older v2.0 or ancient v1.2 kit. Check the kit packaging to determine which version you have! If you have an older version, scroll down to find your parts list!

Also note that Altoids has discontinued their gum. We have [identically sized tins in the store now](http://adafru.it/16) (<http://adafru.it/16>).

Parts list for v3.0

Image	Name	Description	Distributor	Qty
	IC1	5V boost converter LT1302CN8-5 (for v2.0 and V3.0)	Newark Linear	1
	IC1'	8-pin socket	Generic	1
	C4, C3	Power supply capacitor 220uF/6.3V+	Generic	2

	<p>C1, C2</p>	<p>Bypass capacitor (0.1uF)</p>	<p>Ceramic Capacitor</p>	<p>2</p>
	<p>R5</p>	<p>1/8W 5% 3.3K resistor Orange Orange Red Gold</p> <p>This part was added in version 3.0. If you don't have one you may have a version 2.0 kit!</p>	<p>Generic</p>	<p>1</p>

	<p>R2, R4</p>	<p>1/8W 1% 75K resistor Violet Green Black Red Brown</p> <p>This part may also appear as a Brown-body 7502F DALE resistor</p> <p>This part was added in version 3.0. If you don't have one you may have a version 2.0 kit!</p>		<p>2</p>
	<p>R1, R3</p>	<p>1/8W 1% 49.9K resistor Yellow White White Red Brown</p> <p>This part was added in version 3.0. If you don't have one you may have a version 2.0 kit!</p>		<p>2</p>
	<p>D1</p>	<p>1N5818 (or 1N5817, etc) Schottky Diode</p>	<p>1N5818</p>	<p>1</p>

	L1	10uH power inductor, at least 1A current capability	RLB9012-10	1
	X1	USB type A female jack	Generic	1

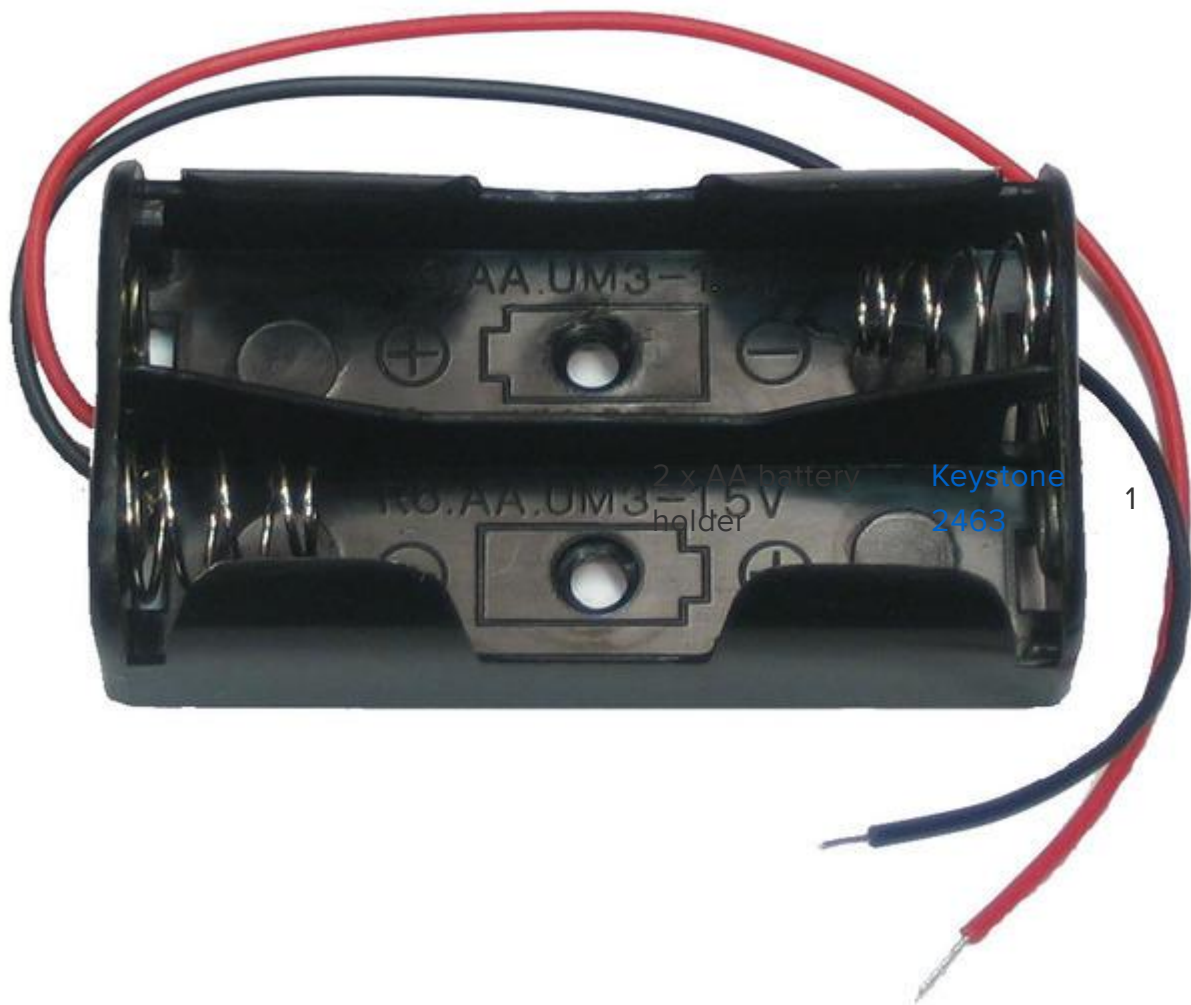

1

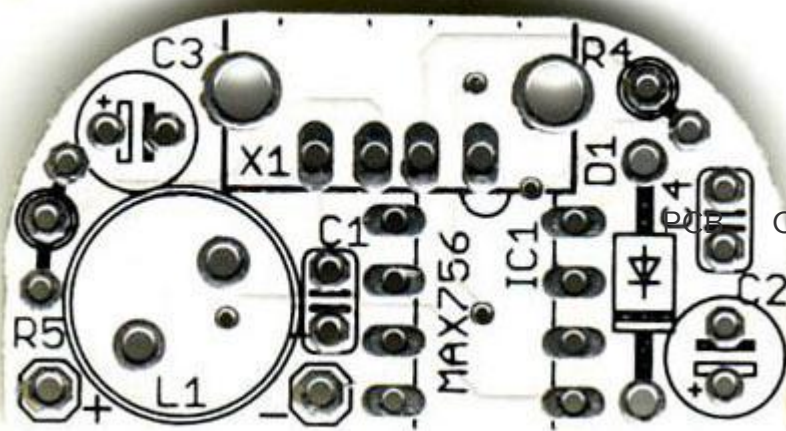

Circuit board

Adafruit Industries

1

Schematic for v3.0

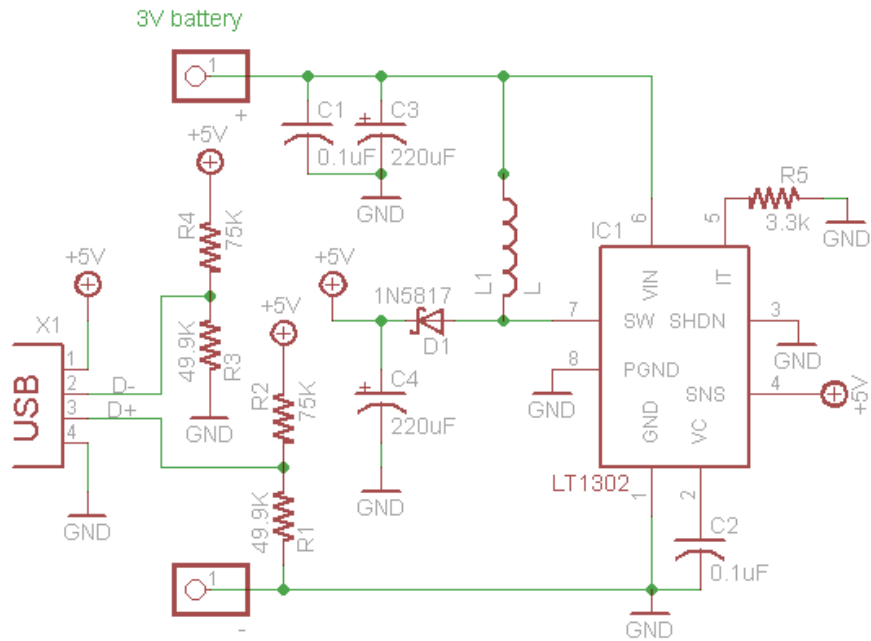





Parts list for v2.0

This kit version was discontinued August 2010 and replaced with version 3.0

Image	Name	Description	Distributor	Qty
	IC1	5V boost converter LT1302CN8-5 (for v2.0)	Newark Linear	1

	IC1'	8-pin socket	Generic	1
	C4, C3	Power supply capacitor 220uF/6.3V+	Generic	2

	<p>C1, C2</p>	<p>Bypass capacitor (0.1uF)</p>	<p>Ceramic Capacitor</p>	<p>2</p>
	<p>R4, R5</p>	<p>15K 1/4W 5% resistor (brown green orange gold) These were included for older iPods and devices.</p>	<p>Generic</p>	<p>2</p>

		<p>100K 1/4W 5% resistor (brown black yellow gold) Alternatives for R4/R5 for the latest iPods (classic, nano video)</p>	<p>Generic</p>	<p>2</p>
	<p>D1</p>	<p>1N5818 (or 1N5817, etc) Schottky Diode</p>	<p>1N5818</p>	<p>1</p>
	<p>L1</p>	<p>10uH power inductor, at least 1A current capability</p>	<p>RLB9012-10</p>	<p>1</p>



X1

USB type A
female jack

Generic

1



2 x AA
battery
holder

Keystone
2463

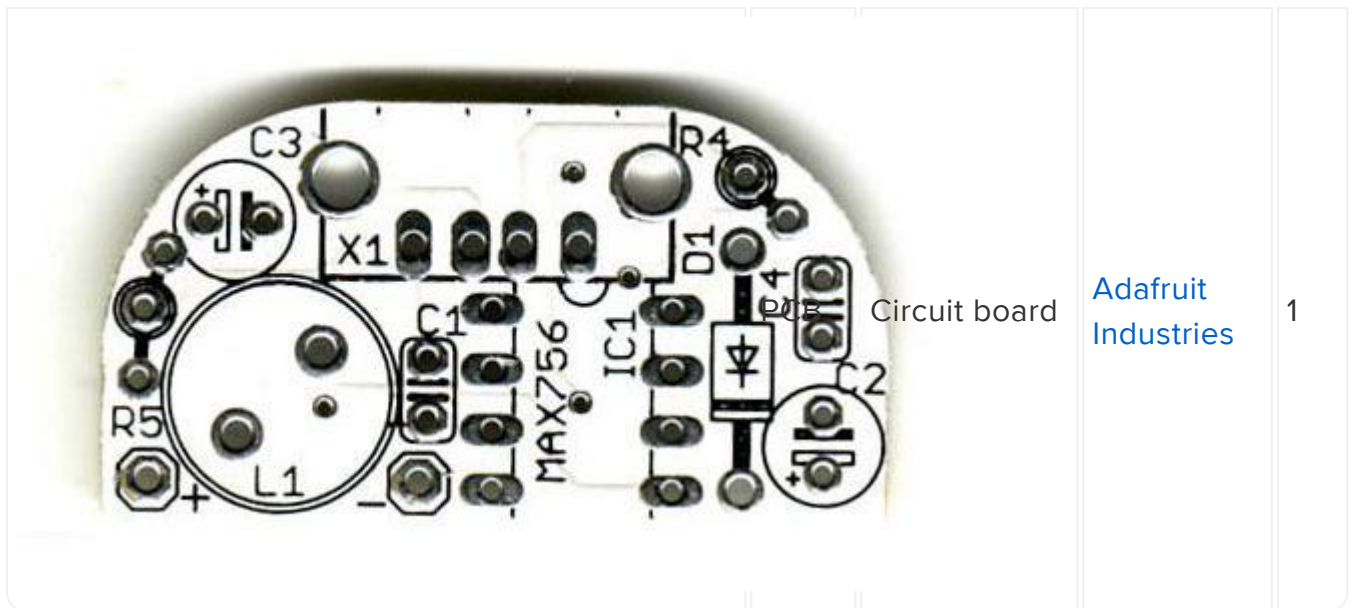

Adafruit Industries

1

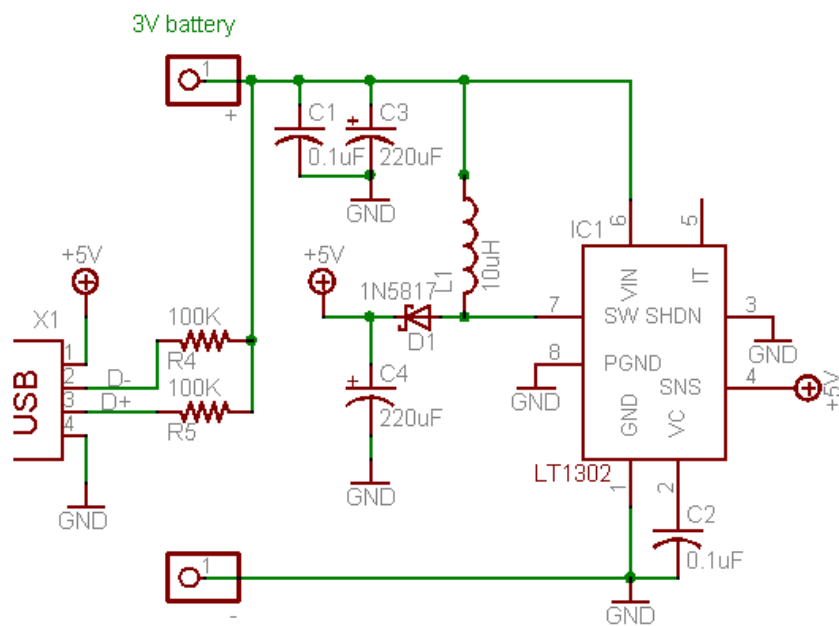

Schematic for v2.0







Parts list for v1.2

This is the parts list for the [quite-old-now V1.0 to v1.2 mintyboosts \(\)](#).

Image	Name	Description	Distributor	Qty
-------	------	-------------	-------------	-----

	IC1	5V boost converter MAX756-CPA (for v1.2)	Digikey Maxim	1
	IC1'	8-pin socket	Generic	1
	C4, C3	Power supply capacitor 100uF/6.3V or higher	Generic	2

	<p>C1, C2</p>	<p>Bypass capacitor (0.1uF)</p>	<p>Ceramic Capacitor</p>	<p>2</p>
	<p>R4, R5</p>	<p>15K 1/4W 5% resistor (brown green orange gold) These were included for older iPods and devices.</p>	<p>Generic</p>	<p>2</p>

		<p>100K 1/4W 5% resistor (brown black yellow gold) Alternatives for R4/R5 for the latest iPods (classic, nano video)</p>	<p>Generic</p>	<p>2</p>
	<p>D1</p>	<p>1N5818 (or 1N5817, etc) Schottky Diode</p>	<p>1N5818</p>	<p>1</p>
	<p>L1</p>	<p>10-22uH power inductor, at least 1A current capability</p>	<p>RLB9012-10</p>	<p>1</p>



X1

USB type A
female jack

Generic

1

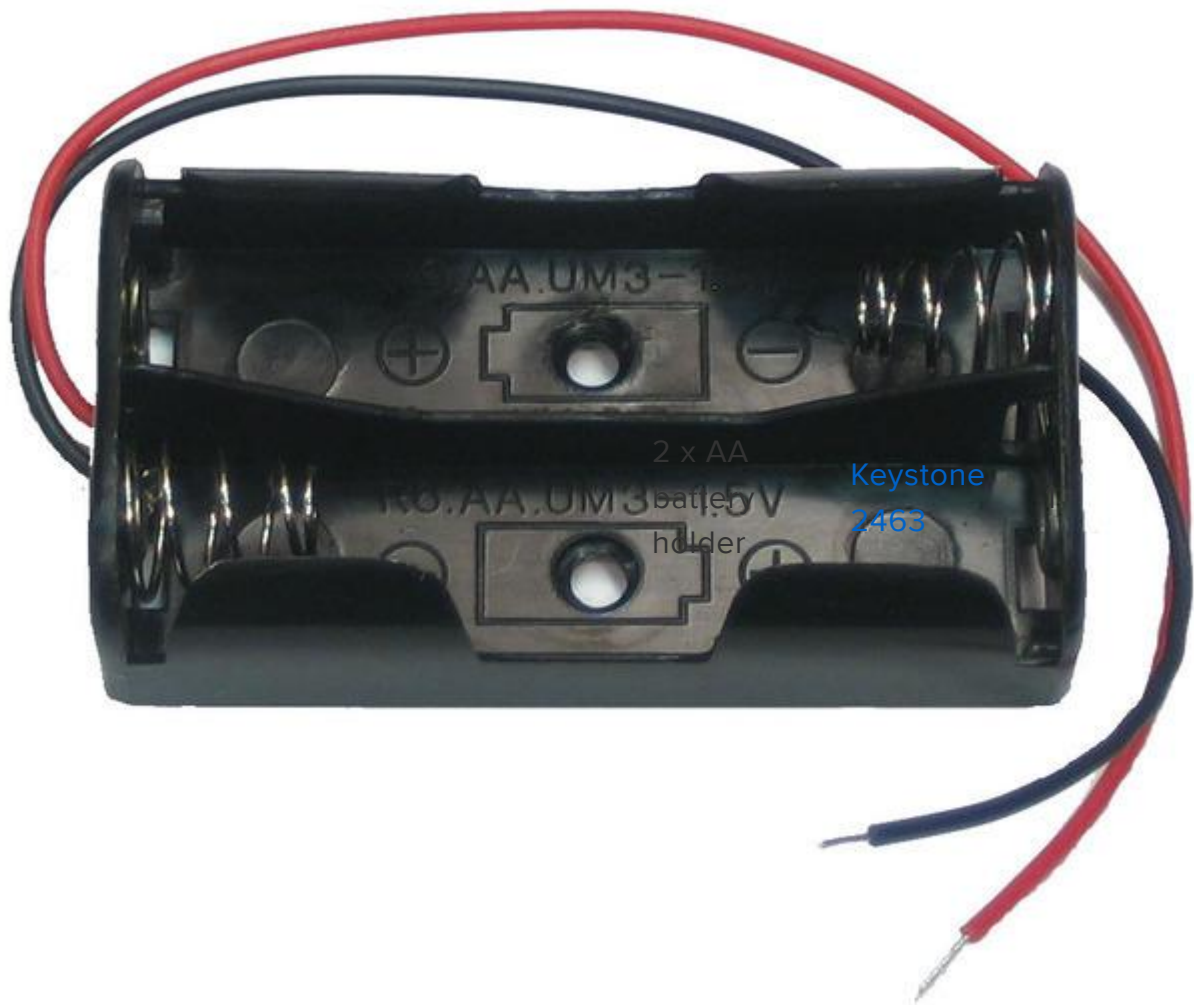

2 x AA
battery
holder

Keystone
2463

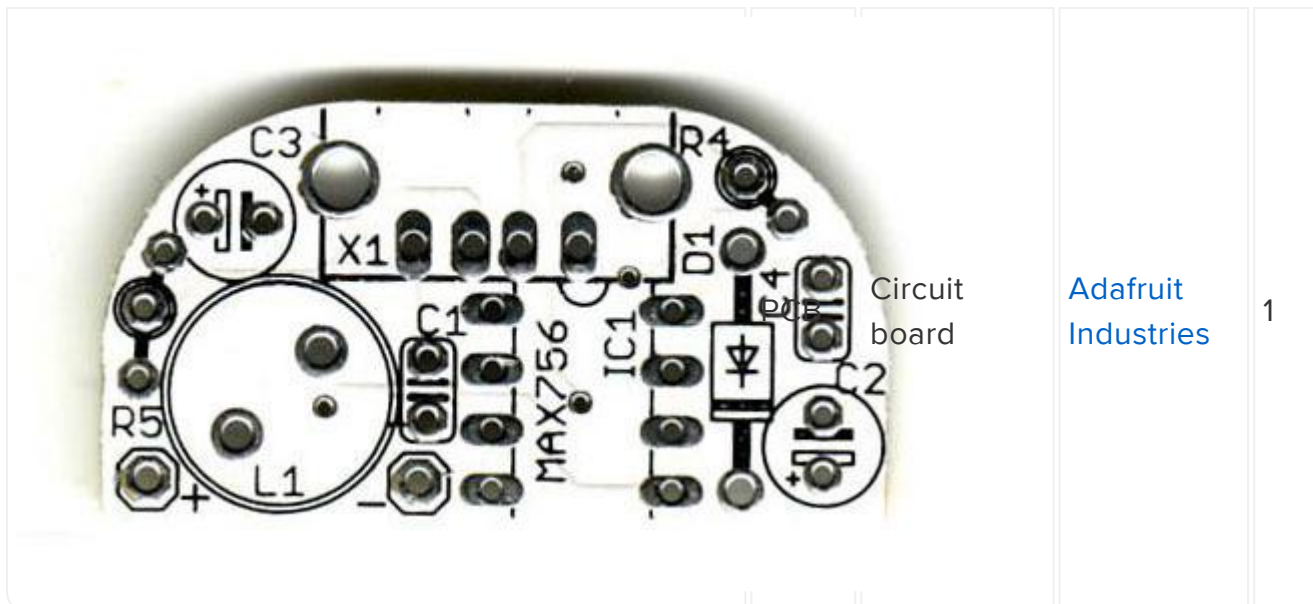

Adafruit Industries

1

Schematic for v1.2

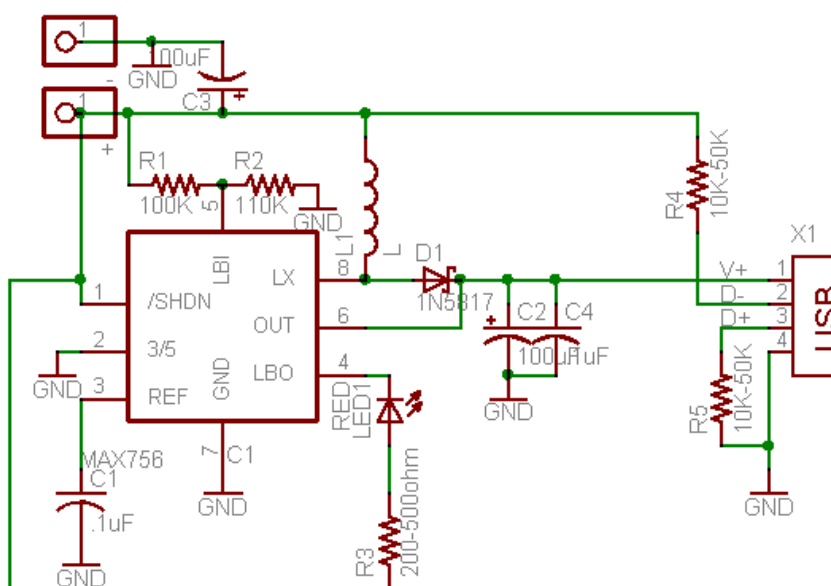

LED1, R1, R2 and R3 are optional, not included in the kit, and should be installed only if the user wants the "Low Battery Indication" function. Check the MAX756 datasheet for information on how to pick R1 and R2.

R5 should be installed as either a pulldown or pullup (like R4) - in the V1.2 pcb there are two positions possible

Mintyboost® is a registered trademark of Adafruit Industries

Solder it

Instructions for Version 3.0

These are the instructions for v3.0, if you have an older mintyboost [you may want to check out the specific instructions for earlier versions \(\)](#).

Solder It!

The first step is to solder the kit together. If you've never soldered before, check the [P](#)
[reparation page for tutorials and more \(\)](#).

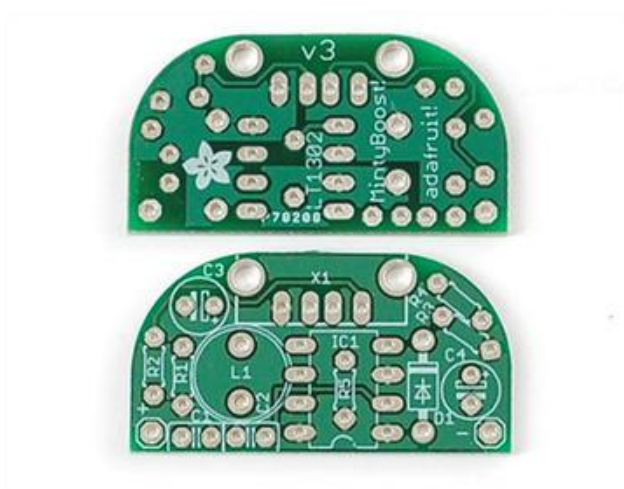

First! [Check the Bill of Materials to verify you have all the parts necessary to make the kit \(\)](#).

Most importantly, check which version of the kit you have. Look at the packaging, and the PCB - find that v3 that's on the back near the top!

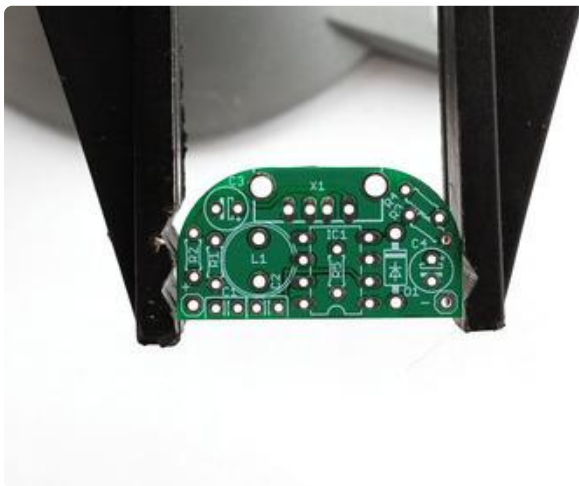

Place the PCB in a vise, and turn on the soldering iron. [Make sure you have all the tools you'll need to assemble the kit \(\)](#).

If you don't know how to solder, we suggest checking out the videos in the link above. They're quite good! Keep them in a window so you can watch and review as you work through the kit

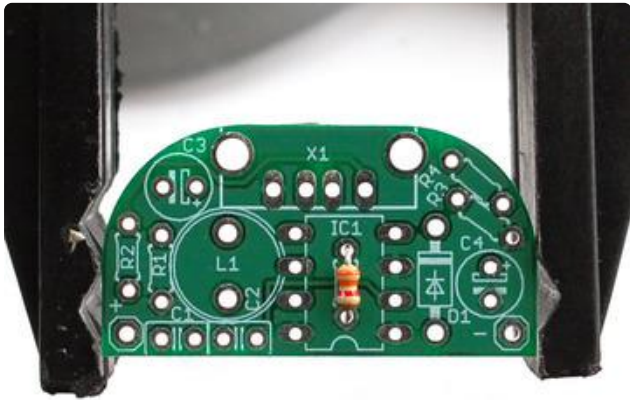

The first part we will place is the resistor R5 - this is a small oval tan thing with two wires (leads) and color stripes. The stripes are orange orange red which indicates a 3.3K resistor. This resistor is used to improve the high current capability of the boost converter chip and is a new addition to the mintyboost. The resistor goes right in the middle, over the silkscreen text that says R5.

Resistors are non-polar which means they don't have a direction: you don't have to worry about putting it in 'backwards' because they work the same either way.

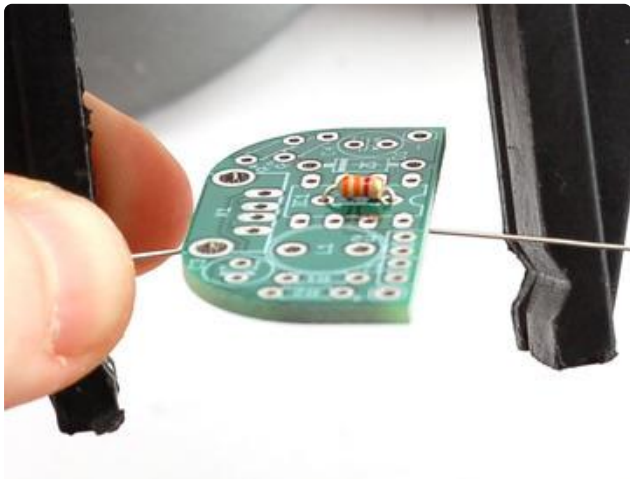

Bend the resistor into a staple and slip it onto the top of the Printed Circuit Board. Bend the little leads out so that you can flip over the PCB and the resistor will stay in place.

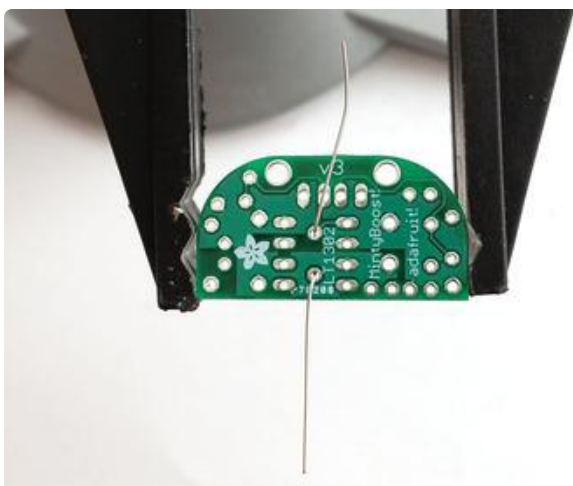

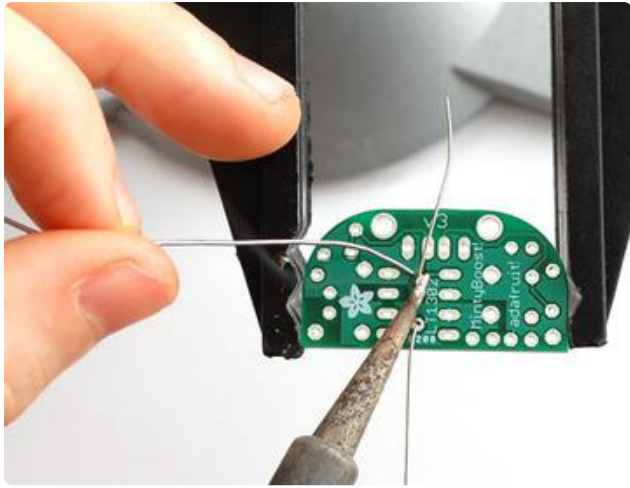

Now you'll solder! Place the flat of the soldering iron tip against the silver ring (pad) and one of the wires of the resistor (lead) at the same time for 2 seconds. This will heat them both up to 600-700 degrees. Then poke the end of the solder so that it flows into the hole and forms a solder joint.

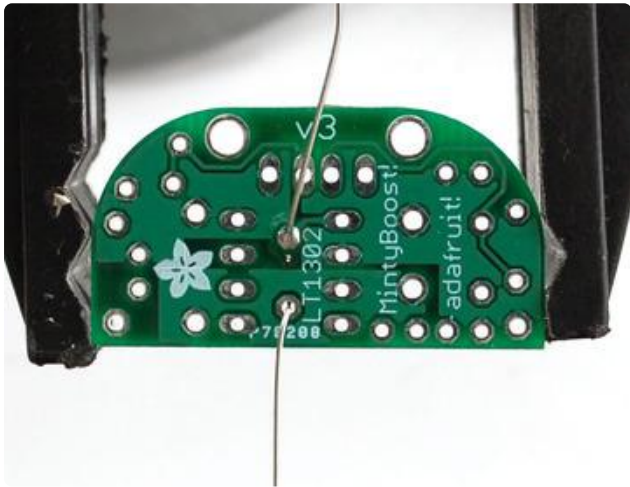

Solder joints should be smooth and shiny and fill the entire pad, wicking up to the lead. You shouldn't be able to wiggle the wire and have it move in the hole.

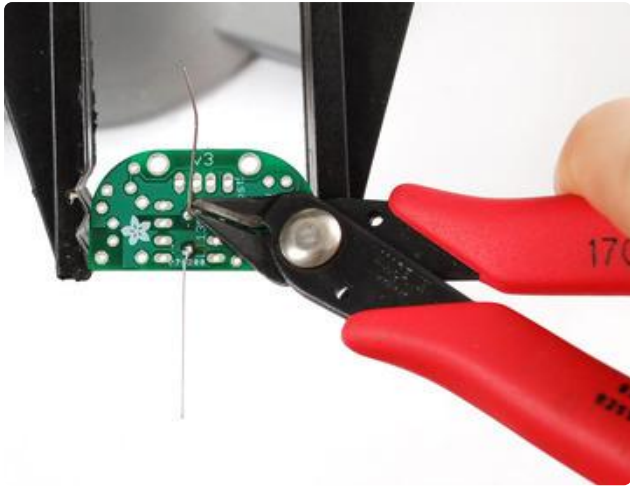

Now we will get rid of all that excess wire. Use your diagonal nippers to clip the wire just above the end of the solder joint. There should be almost no 'wire' sticking out.

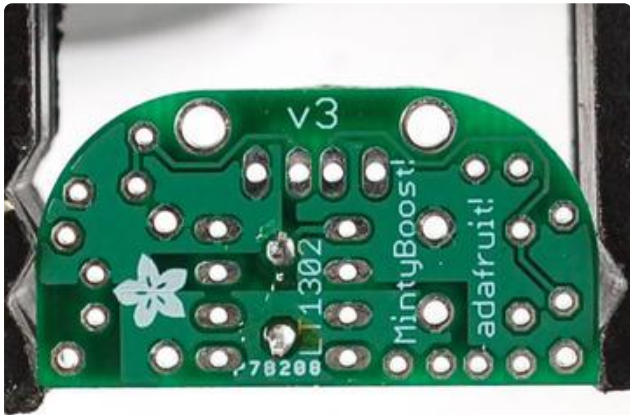

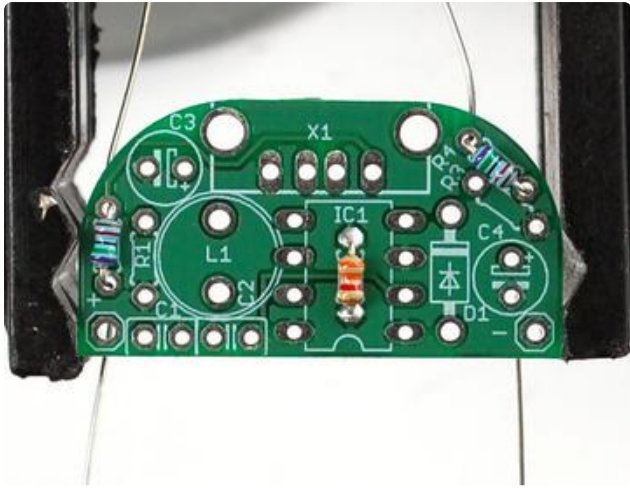

Next up we will solder in the 75K 1% resistors R2 and R4.

These resistors are blue and have the following stripe colors: Violet Green Black Red Brown. They're very small and easy to confuse with the other blue resistors, but the other resistors have white and yellow stripes so perhaps look and make sure your resistors don't have any light stripes on them?



You might also have brown 7502F DALE resistors that are a little larger, in this case you can double the resistor over like this and solder it in the same spot. They won't sit flat but that's alright!

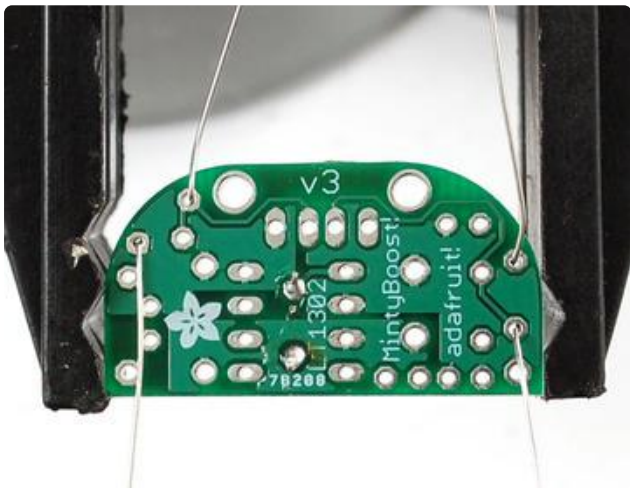

These resistors are used by Apple iPhones and such to determine what kind of charger is connected ().

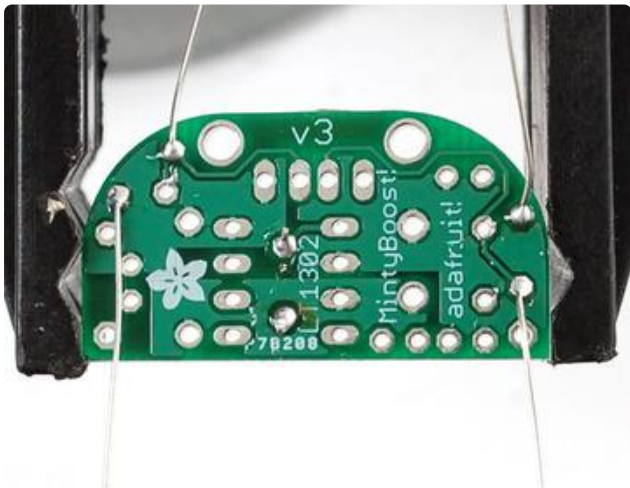
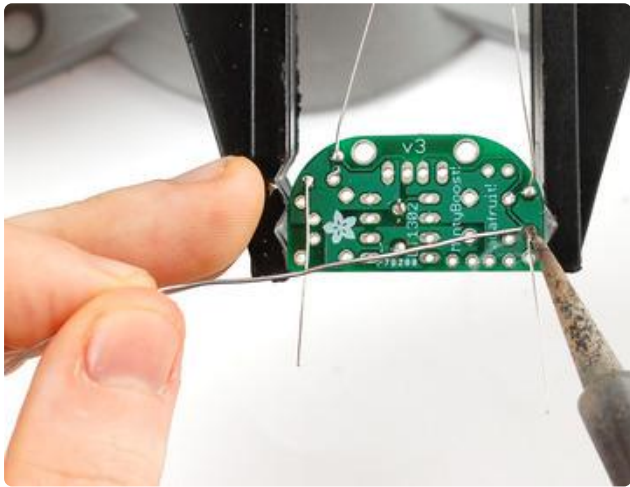
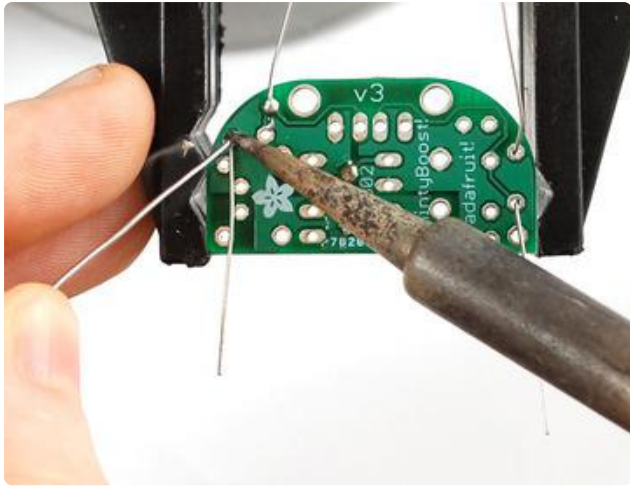

Solder the resistors as you did the 3.3K one, one point at a time, checking your work.

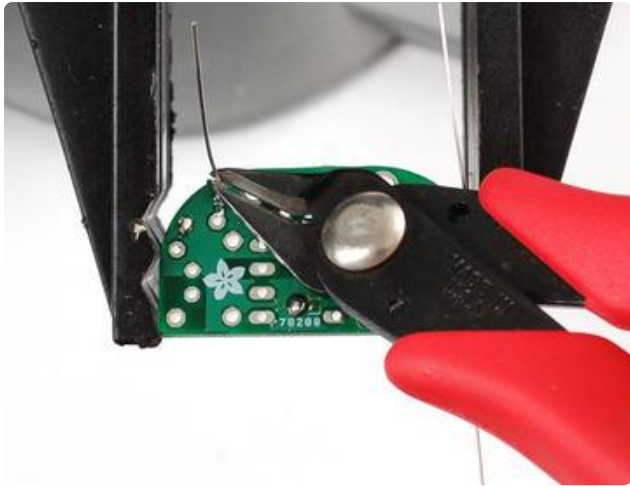

Clip the long ends.

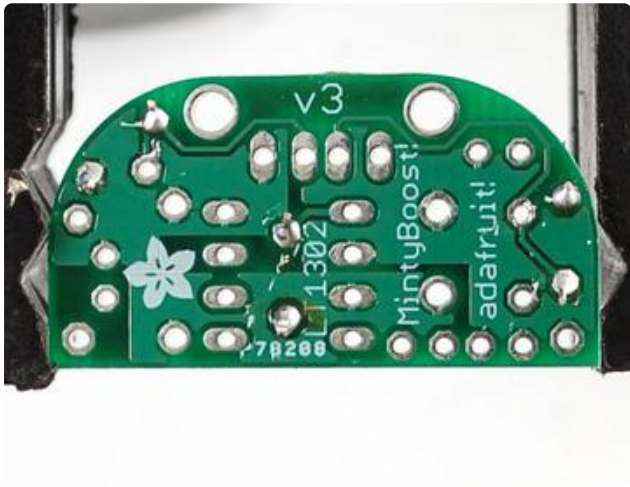

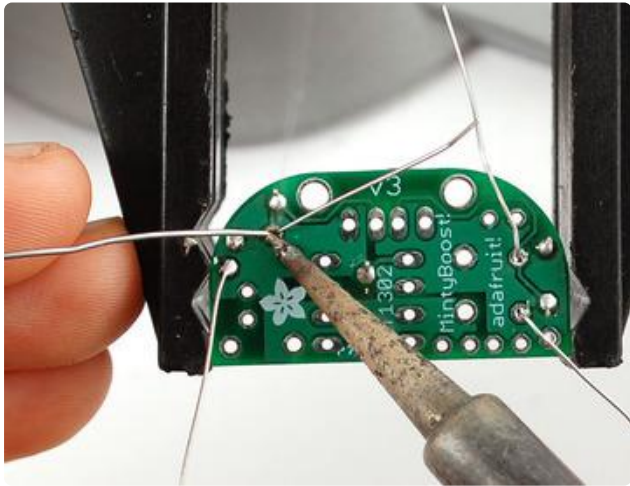
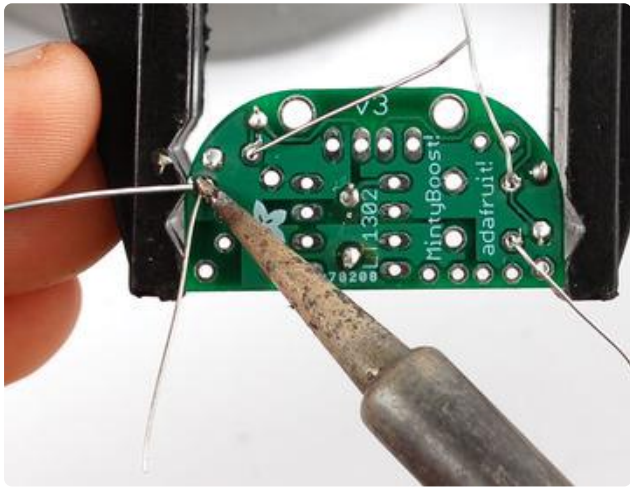
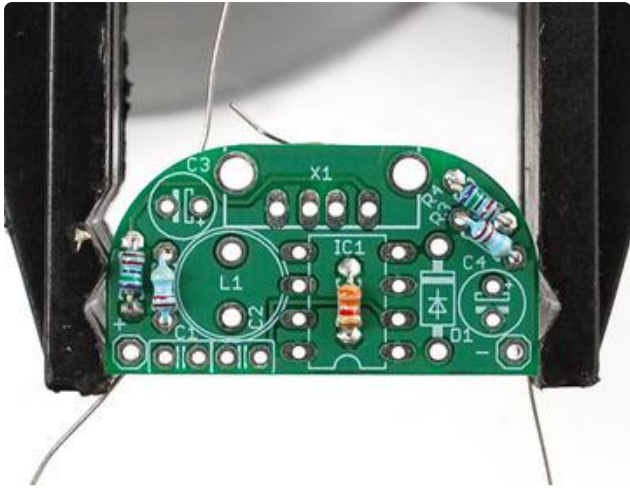

We will now finish up with the resistors. grab the last two left, these are 49.9K 1% resistors and have Yellow White White Red Brown stripes. They go into the slots R1 and R3.

These resistors are used by Apple iPhones and such to determine what kind of charger is connected ().

Solder them in.

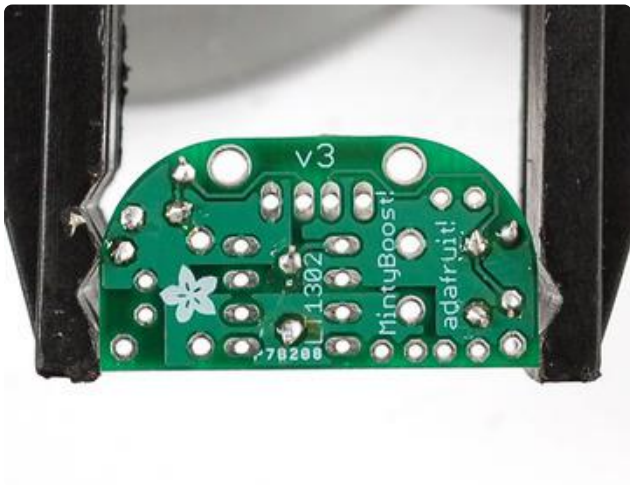
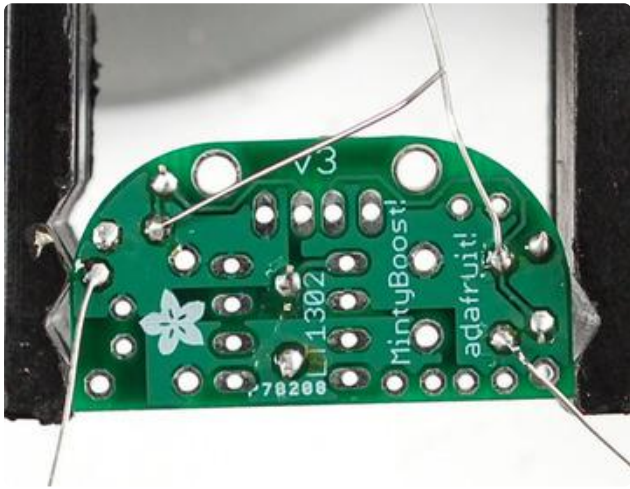
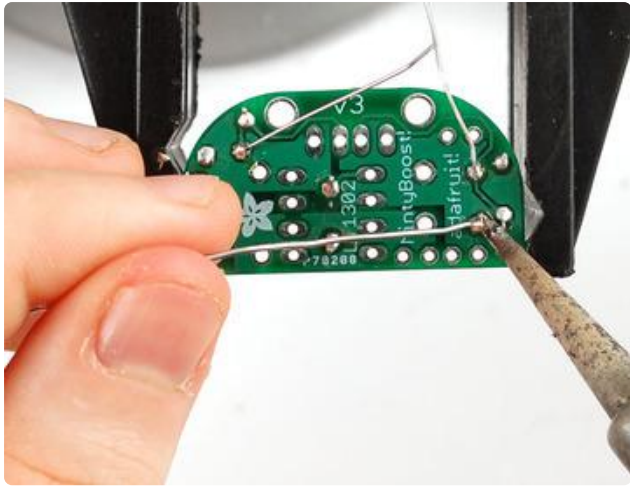

Clip the leads so it's nice and tidy.

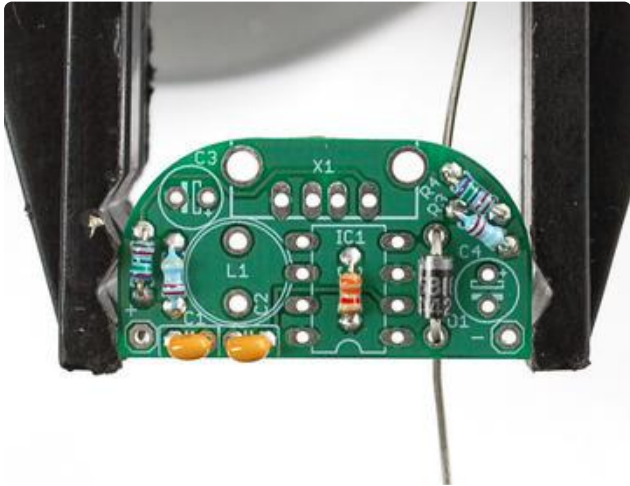

The next type of part we'll place is the ceramic capacitor. These are parts C1 and C2. Ceramic capacitors have a nice property that they are symmetric/non-polarized. That means they can go in 'either way'. Place the capacitor so that the 2 legs (leads) slide thru the two metal holes in the PCB (pads). The capacitor will sit flat against the PCB.

C1 helps stabilize the output voltage, and filters out high frequency noise so that the 5V output is nice and smooth.

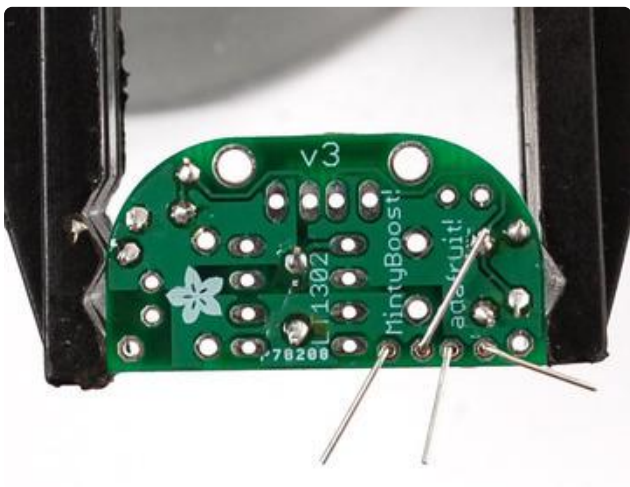

Now it's time for the next capacitor, C2. This capacitor is used to stabilize the internal reference of the boost converter chip. This keeps the chip stable so that it will generate a voltage as precise as possible.

(We forgot to take a photo of placing them so we stole the next photo which also shows a black and white diode, don't place that yet...just the two yellow blobbies)

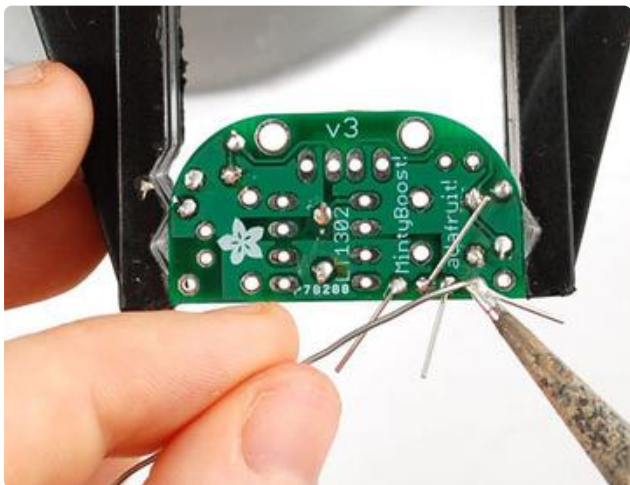

Solder and clip these parts!

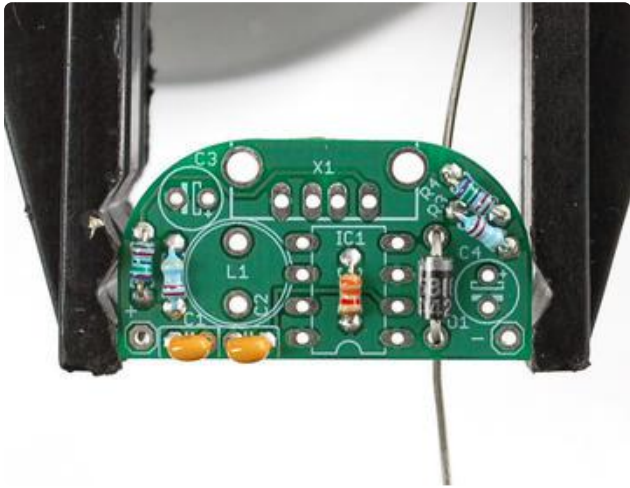

Next is the schottky diode D1. This diode is part of the boost converter. Essentially it is used to make sure energy is transferred in only one direction-from the batteries to the USB port. Diodes have a special property that current can only pass thru them in one direction. That means that it is important to make sure that they are not inserted in backwards. Examine the diode and find the end with a white stripe. This stripe should match up with the silkscreen image, which also has a stripe on one end. In this image, it is towards the top.

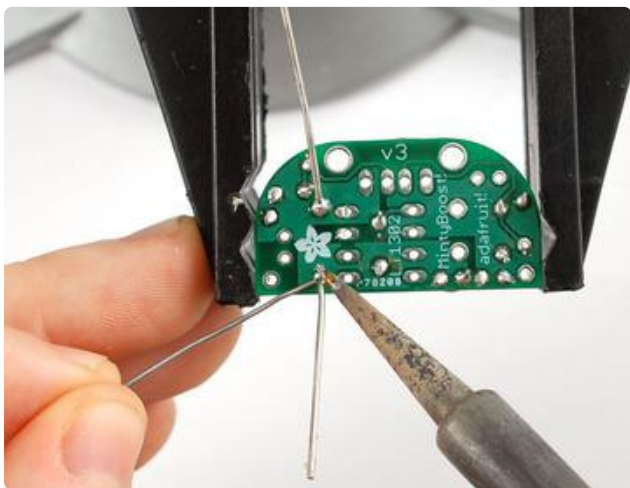
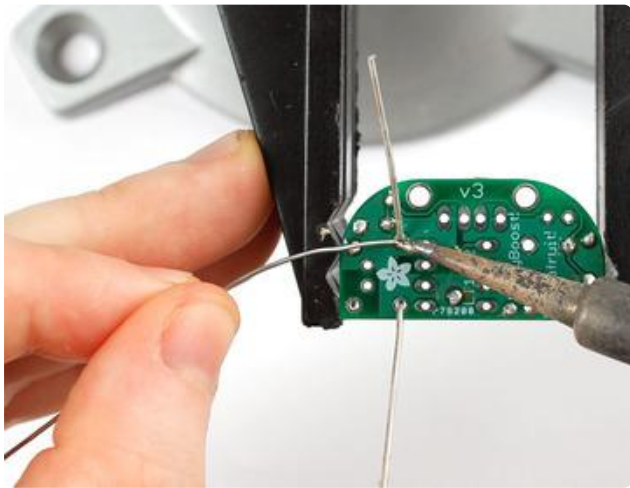

Solder and clip the diode.

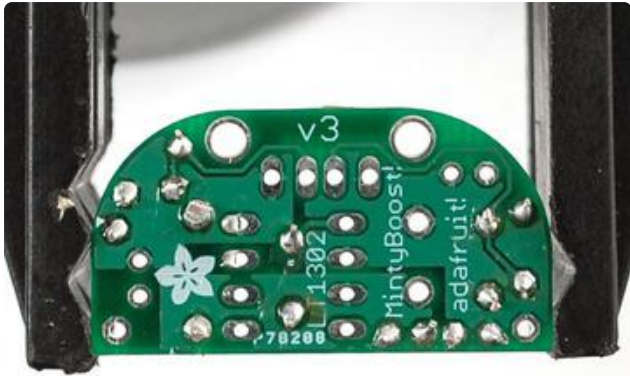

Lookin' good! Make sure there are no shorted wires or 'dirty' solder joints.

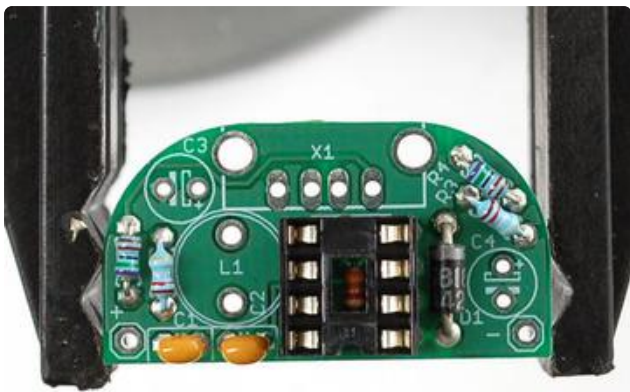

Next is the IC socket. This protects the chip and allows you to replace it if there are any problems. The socket goes over the 3.3K resistor but the resistor should not interfere as long as it was soldered in properly.

Make sure you solder the socket in so that the notch in the edge of the socket matches up with the notch in the silkscreen image of the socket. In this image it's near the bottom. If you mess this up, dont try to desolder the socket, instead just keep going and remember that it is upside down later when it's time to install the chip.

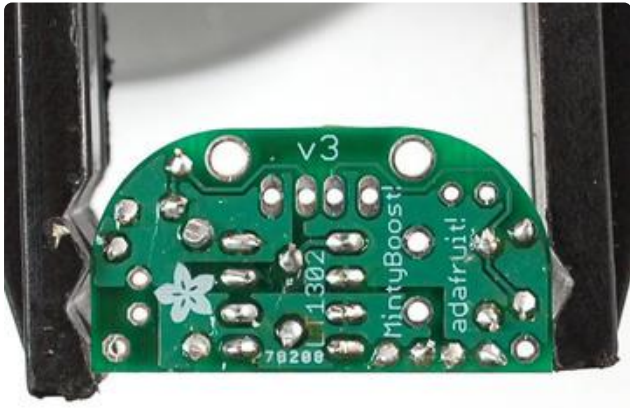
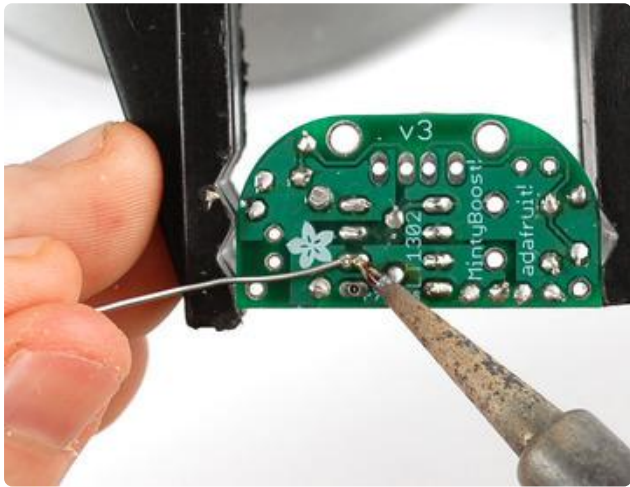
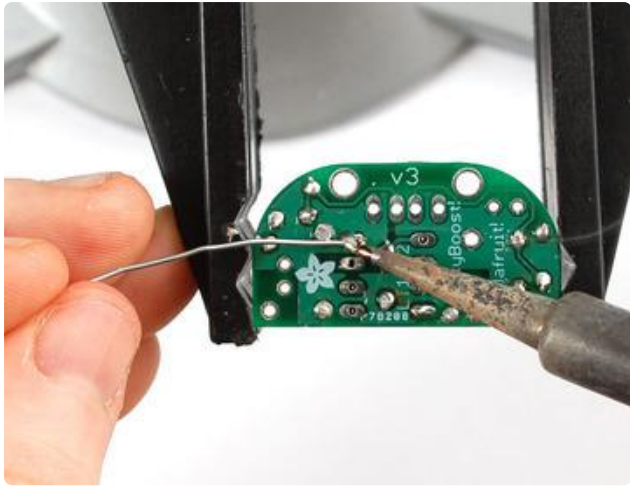

The socket has short legs so it can be annoying to keep in the right position. Hold it in place with one finger and 'tack solder' a corner.

Once that is done, solder in the remaining 7 pins. There is no need to clip.

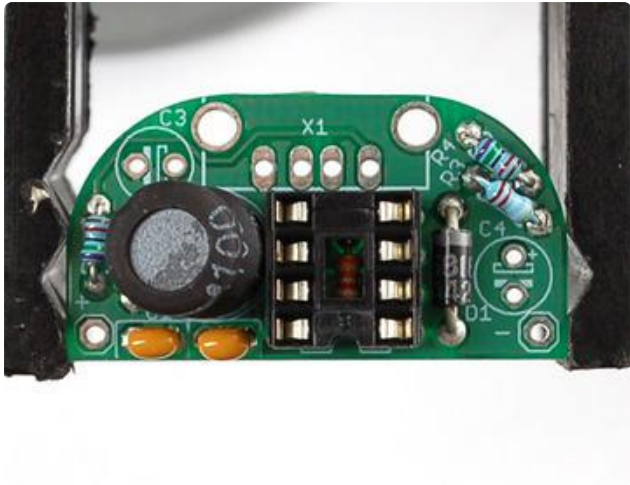

Next is the power inductor L1. This component is used by the DC/DC converter chip to store and convert power from low voltages to high. Inductors are just a coil of wire so they have no polarity and can be placed either way.

The inductor may not sit perfectly flat, since the socket is in the way a bit. That's ok, just lean it over a little.

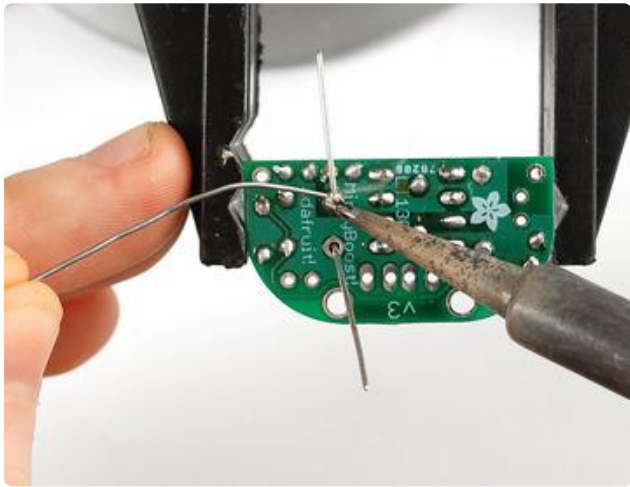

Solder in both wires and clip them short.

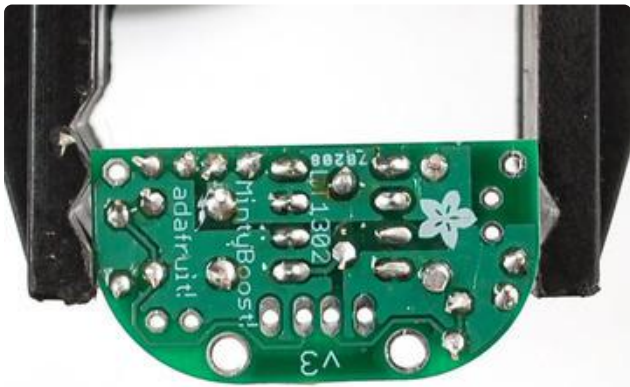

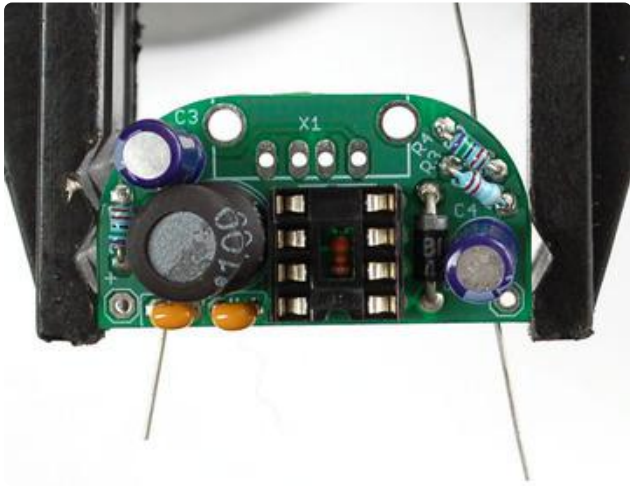
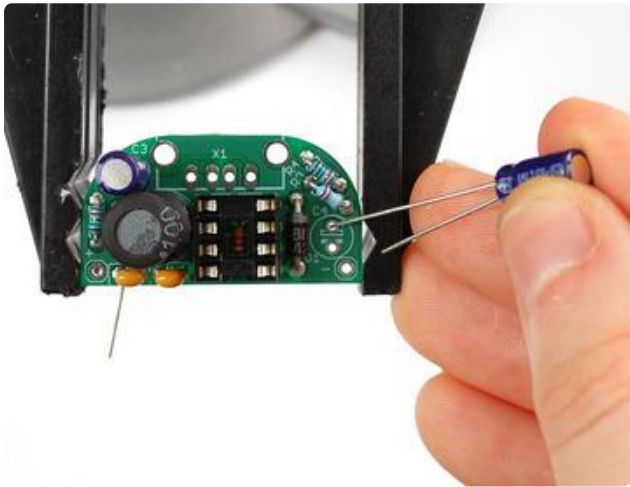
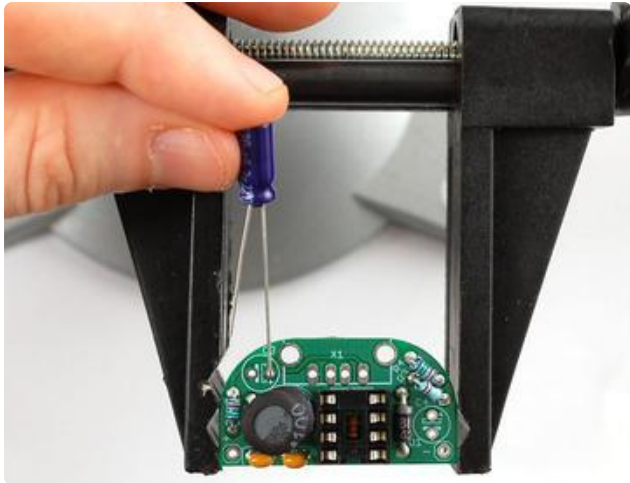

Next are the two electrolytic capacitors. These help smooth both the input and output voltages, to keep them stable during the up-conversion. They are used for low frequency noise, and are often paired with a ceramic capacitor.

Electrolytic capacitors are polarized and must be placed correctly or the circuit will not work. The longer lead is the positive (+) one and must go into the pad marked with a + as shown.

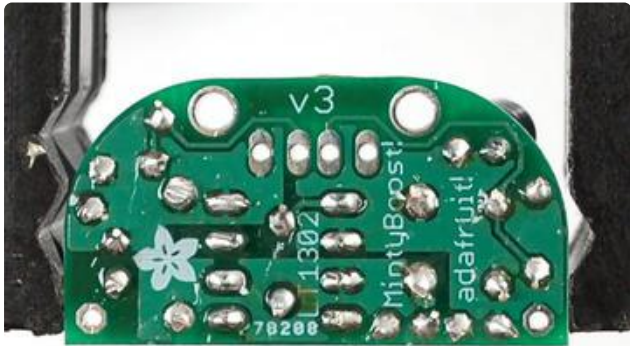
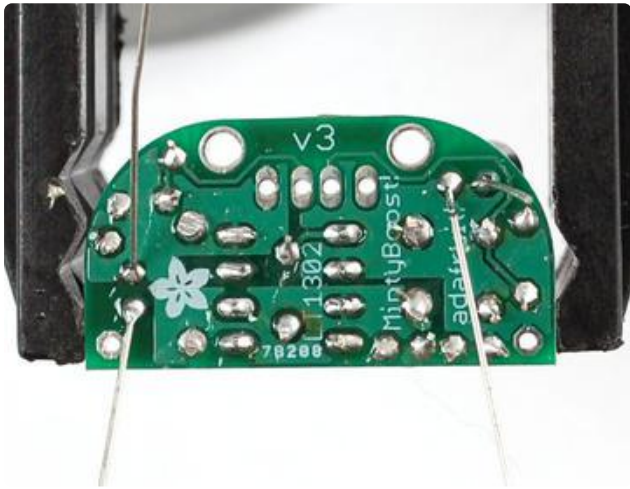
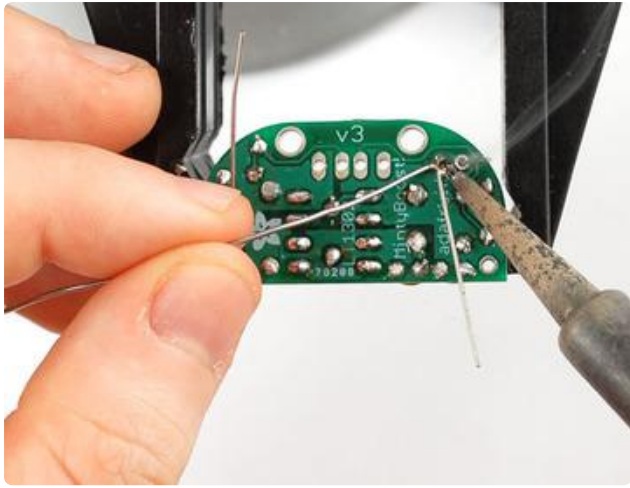

Solder in the two capacitors then clip the wires.

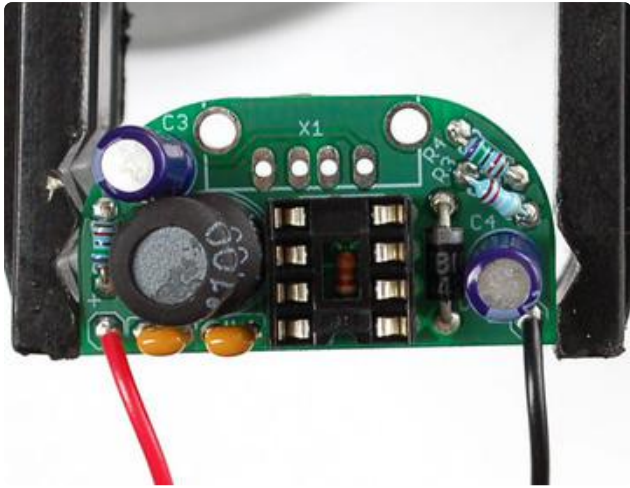

Next, solder in the 2xAA battery holder. The red wire goes to the hole marked + and the black wire goes to the hole marked -.

Make sure you have them in right or you can damage the circuit!

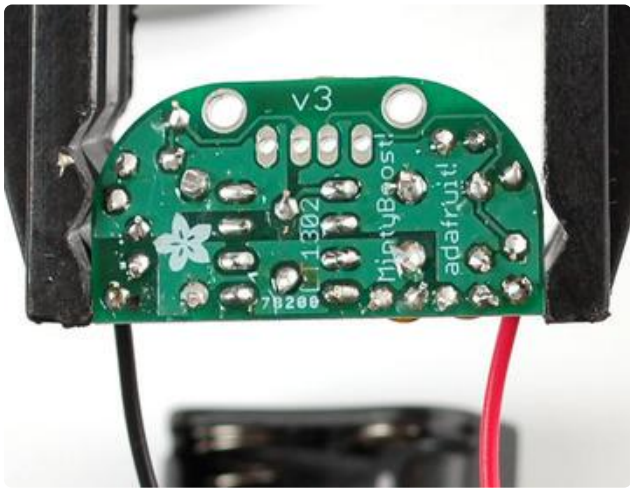
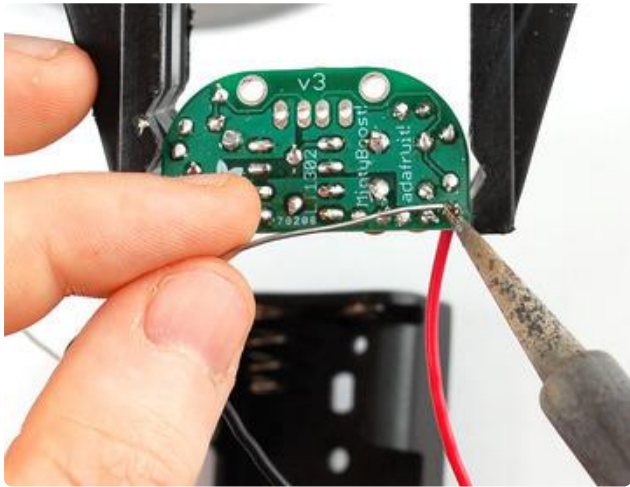
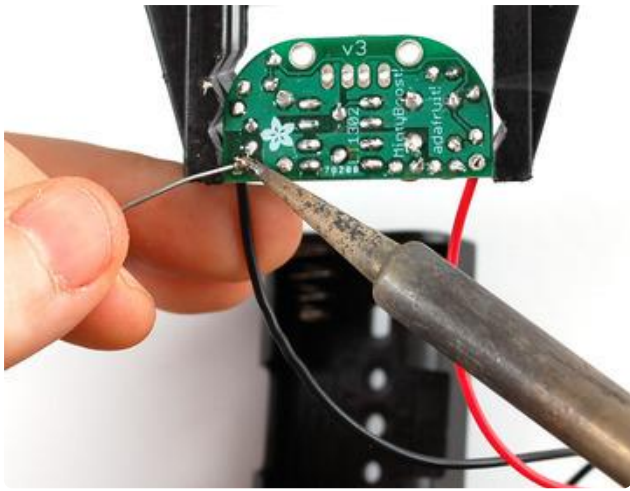

Solder in the wires, if they're a little long you can clip them.

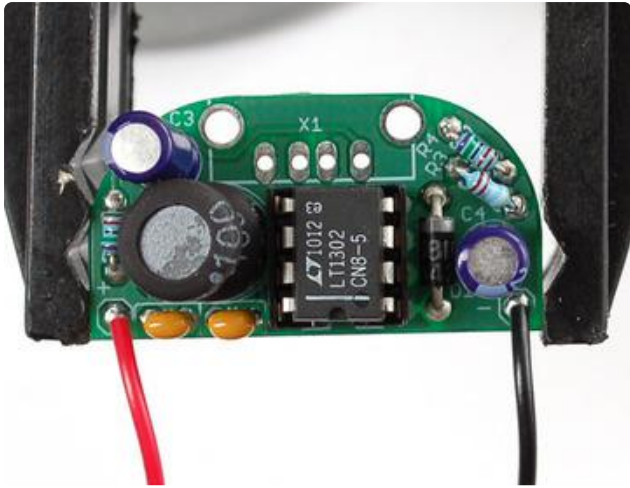

Finally, carefully insert the boost converter chip. Make sure the notch in the chip matches the notch in the socket. If the socket was inserted backwards, make sure the notch faces the flat edge of the PCB as shown. Make sure the chip is seated all the way in and that the pins aren't bent.



Time to test! Clean up the desk so there are no little wire pieces that can short the kit (it's also just nice to have a clean desk).

We like to put down a piece of paper to ensure there's no chance of damage. Then insert two fresh AA batteries - alkaline or rechargeable is OK.

Wait a few seconds and feel the battery and chip. Are they getting hot? If so, remove the batteries and look over your work. The kit should not even get warm!

Use your multimeter ([hey you know how to use a multimeter right? If not, please read our voltage tutorial here \(\)](#)) to measure the voltage in the two outer pins of the USB connector.



You should get a bit higher than 4.8V but lower than 5.2V.

If you get higher than 5.2V or lower than 4.8V, first check that your multimeter has a fresh battery. Really! this is a really common problem!

If you get lower than 3V, remove the batteries and check your work.

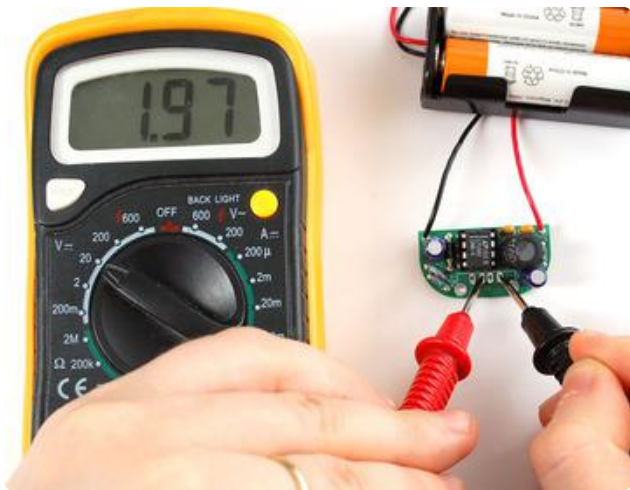

Next check between the rightmost pin and the second and third pin. They should both be at just about 2.0V

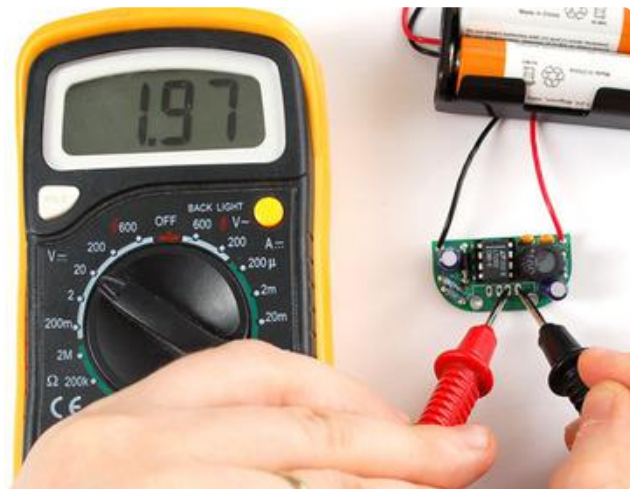

Once you are happy with these tests, remove the batteries and finish assembling the kit!

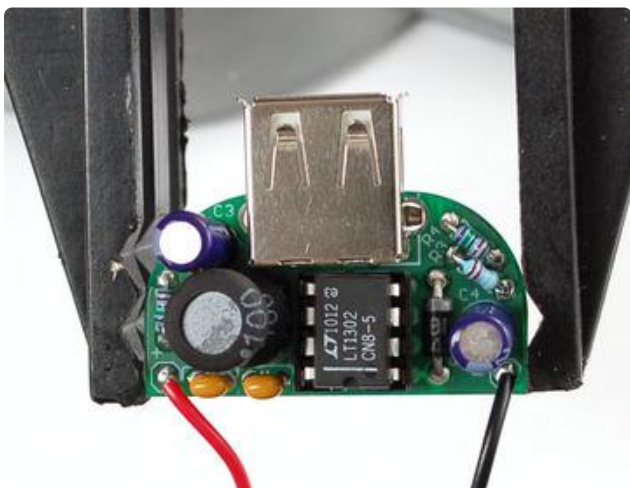

Next is the USB type A connector. This is the connector that is on a computer, and nearly all USB charging cables will plug into it. The Connector should snap easily in place.

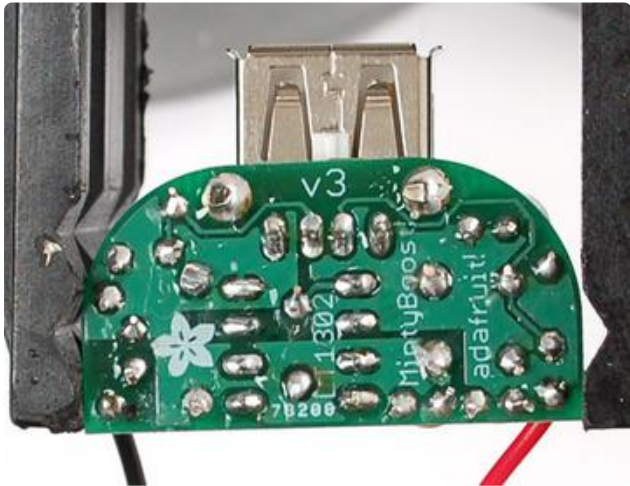
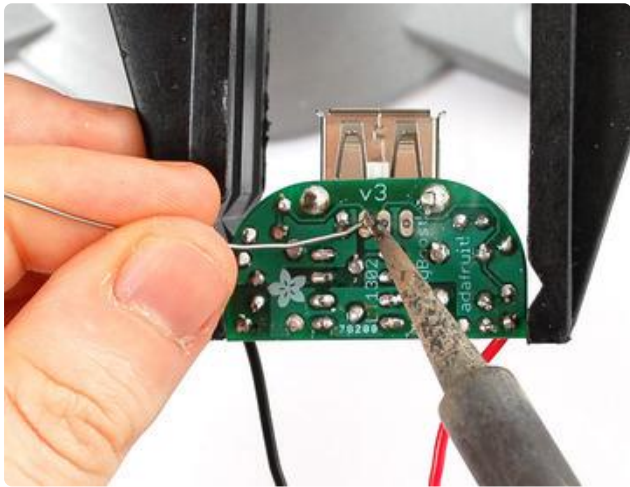
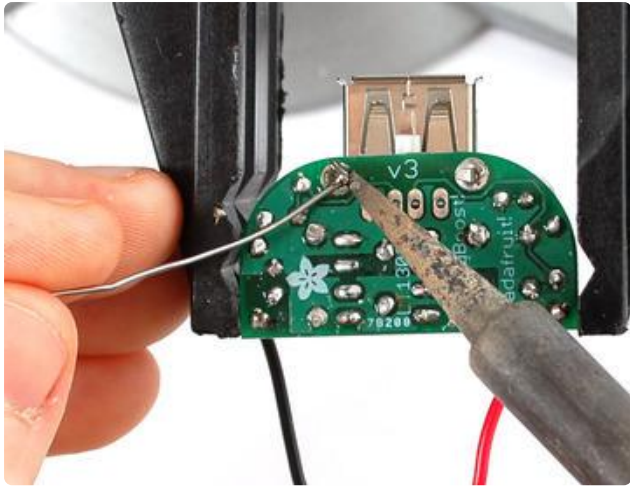

The two large side connectors are used for mechanical strength. They keep the connector attached solidly to the PCB so make sure to use lots of solder or it will break off from use.

The four middle pins carry the power and data for USB. Solder in all four.



Now is a good time to test your kit - before you put it in the case. Check that it charges your favorite gadget and perhaps wait a few minutes to make sure that the battery meter inches up

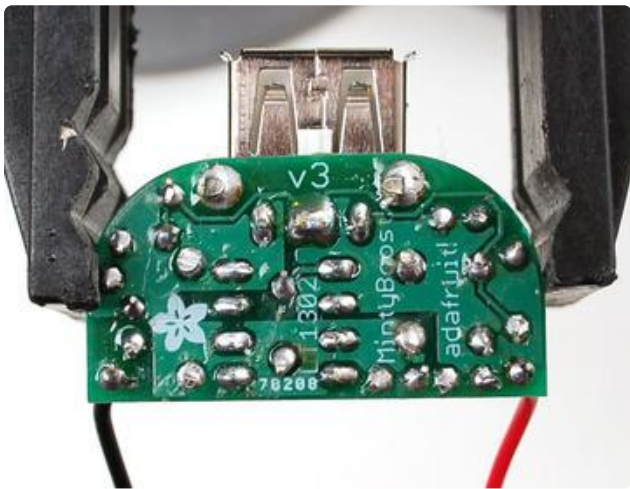

If you are having trouble getting the device to recognize the Mintyboost as a charger, it could be because it only wants 'USB spec' chargers. This is easy to do with the Mintyboost and always worth a shot as it will get most stuff up and running.

Remove the batteries from your kit! Then using your soldering iron, heat up the two middle USB pins at the same time and blob on a bunch of solder to short them together.

Now try again!

Mintyboost® is a registered trademark of Adafruit Industries

Case it

OK, now you're ready to put it in the case. Go buy a tin of Altoid gum, and eat them or give them to your friends. I think they're disgusting so don't send them to me.

Note that Altoids has discontinued the gum. However, we did manage to find a source of gum-sized tins and we have them in the store (see the link to the right)



You'll need the MintyBoost kit, an empty gum tin, a pair of tinsnips and two pieces of doublesided foam sticky tape (the tape is included in the kit).



Cut two notches in the end of the tin, just about where the flat part ends and the tin starts to round out.



Now you want to bend the flap back and forth to break it off, if you're careful you can bend it in more than out which will make it round into the tin, one less sharp edge.





Try a test fit. Slide the board in first, then fit the battery pack in. Don't put the batteries in for this test! The circuit board could short against the tin and destroy the circuit!



Once you're happy, remove the electronics and put the doublesided sticky foamtape on both the circuit board and the battery holder.



Remember to make sure no pin or parts or leads are sticking out and can touch the tin.

Use duct, foam or, electrical tape to protect the circuit. Clip your leads short so they dont poke through the foam. You can easily destroy the circuit by being sloppy here.





You're done! Remember that because the boost chip uses virtually no power, you don't have to remove the batteries to turn off the MintyBoost. Just plug and unplug devices whenever you want.

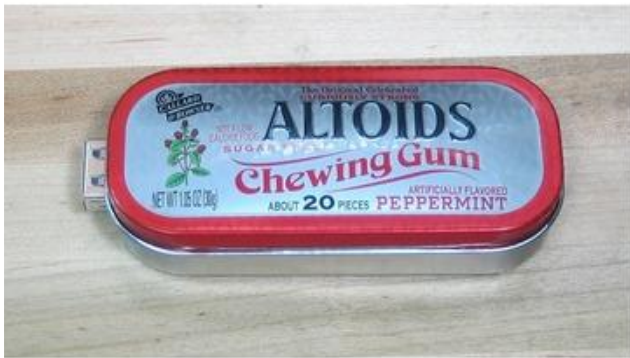

Here is a hack that was sent in by KRHAINOS, for making the mintyboost more sturdy, click to see the large version of the image.

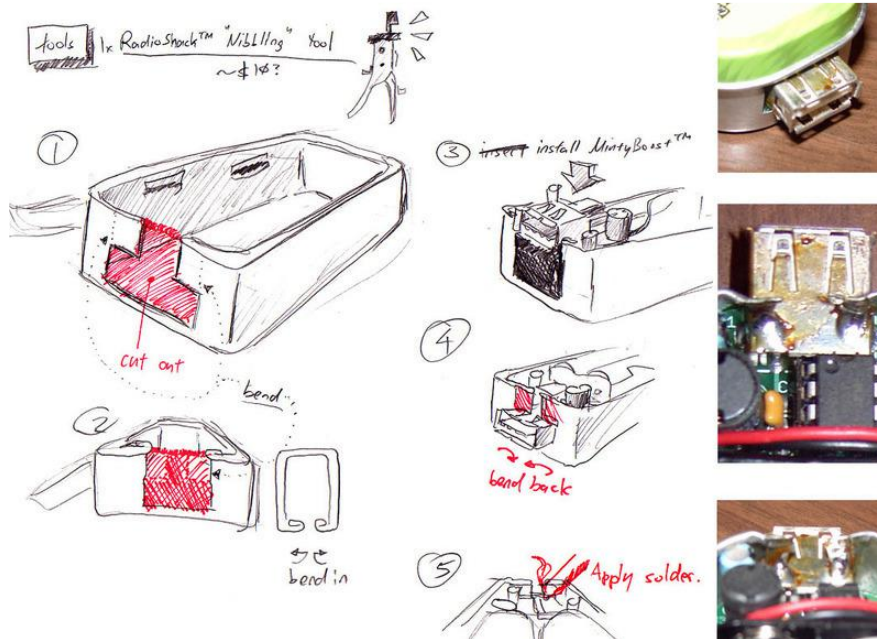

Mintyboost® is a registered trademark of Adafruit Industries

Use it!

Tips and tricks, how to use your MintyBoost

The MintyBoost User manual!

- [How to use the Mintyboost \(\)](#)
- [Batteries! How to get the most out of your mintyboost from picking the right AA's to rechargables, to mega-capacity, and more! \(\)](#)
- [Compatibility list for the latest v3 Mintyboosts \(\)](#)
- [Compatibility list for older v2.x Mintyboosts \(\)](#)
- [The mysteries of Apple iDevice charging...revealed! \(\)](#)
- [Changes between versions of the Mintyboost \(\)](#)

How to use

Basic User Manual

Go MintyBoost!

Here is a basic instructional manual that will cover pretty much everything you need to know about the mintyboost you just built.

Compatibility

So, does it work with your gadget? First you can always visit our compatibility list which we keep updated. We have a list for [versions 2.x \(\)](#) of the kit and [3.x \(\)](#). We try to keep the list updated as much as possible - if something is not on that list then it doesn't mean it doesn't work, just that we don't know. Almost all devices charge fine!

One thing you can always do is try it out! Wait until the battery is halfway drained, then plug your gadget into the USB port and wait a few minutes and see if the battery inches up or if the charging light goes on. You can also feel the mintyboost to see if it's warming up which would indicate it's providing power to the gadget.

Which batteries to use?

Basically, get the best batteries you can. New Lithium or Alkaline 1.5V batteries work great as do fully charged NiMH rechargables. Old, worn out or dead batteries will not

work at all.

[We have a very detailed tutorial about batteries in case you want a lot of details \(\)](#).

How to charge

Easy, get a USB charging cable for your gadget, nearly all come with one these days, you can also usually get one for cell phones or games at an accessory shop. Plug in the USB end into your mintyboost and the other end into your device. That's it! The gadget will draw power to charge up the battery.

While charging...

While charging your device, you may notice the Mintyboost and batteries getting very hot. This is normal, it's because of how much power is being delivered to the gadget! The Mintyboost will cool down as soon as you unplug it. The maximum temperature for the mintyboost chip is over 100 degrees C, that is hotter than boiling water. If you are worried, lick your finger (a little) and touch the tip of your finger to the top of the LT1302 chip. If you don't hear a sizzle (of the water boiling away), it's just fine.

If the mintyboost is getting really hot when it's not plugged in, there may be a short! Remove the batteries and check to make sure there is insulation between the mintyboost PCB and tin.

You may also hear a 'hiss' or 'squeak' coming out of the chip. Sometimes the inductor resonates with the boost converter and that resonance leaks into the audible range. While it's not good for it to always vibrate, it does happen rarely and is not harmful to the charging device. You can try moving the inductor a little with your finger but the noise is electrical in nature so it's hard to stop completely.

Another thing is that it depends on how much power the device is drawing and what kind of batteries are inside.

When to stop charging

The mintyboost will charge and charge until the batteries give out and the voltage output isn't 5V anymore. At this point the batteries are toast and you won't be able to squeeze any more power out of them. However, some phones and mp3 players (especially ones that start with an 'i') are not very smart and even if there is no more power coming out of the charger, they stay on, which means they slowly drain back down.

Basically, the best way to avoid this is to not leave the mintyboost plugged in overnight. Just charge for a few hours or while you're using it!

For Apple products, you can also use the charging icon as a hint, while the Mintyboost is still working, you'll see this icon:



When it's done, you'll see a plug icon - the device may also beep or buzz when this happens. At this point, you should unplug the mintyboost and get new batteries for it.

Batteries

User manual - Choosing batteries

Batteries?

The most important part of using your Mintyboost is choosing and installing the right batteries. Poor quality batteries will cause frustration, and using the wrong kinds can damage your kit!

Please read this guide which will cover all the kinds of batteries you can use.

How the mintyboost works

The mintyboost is a voltage source which means it tries its hardest to make sure the output is at 5 volts no matter what the current draw (by the target device) is. The

device you are charging (mp3 player, etc) is a resistive load. That means it basically sucks as much power as it wants out of the mintyboost.

The device you are charging is almost certainly very 'stupid' - it doesn't know or care that you are trying to use AA batteries to recharge it. Most devices assume that you are plugged into the wall or into a computer (which is plugged into the wall) and suck as much power as possible to quickly charge up so you can listen to music or make phone calls.

This, of course, is a bit of a tradeoff. The higher the current draw, the harder the mintyboost has to work, and the AA's have to work. They'll get hot, they lose efficiency, the batteries drain and droop. There is no way for the mintyboost itself to fix this, it is completely up to the phone or music player!

For that reason, we need to have good batteries, that will be able to work well while being drained fast!

Standard AA's

We suggest using two AA batteries to run the Mintyboost - that's why we include a 2xAA holder in the kit! AA batteries are common and inexpensive and provide a good amount of voltage and current. (See below for detailed information about voltage and current guidelines) However, not all batteries are made the same! Picking the right kinds of batteries will give you the best results.

In approximate order of effectiveness, here are the non-rechargeable batteries you will want to use:

1. Lithium 1.5V 'high drain' AA batteries (2900 mAh)
2. High quality (Duracell/Energizer) 'high drain' alkaline batteries
3. High quality (Duracell/Energizer) alkaline batteries
4. Non-brand Alkaline batteries
5. Other kinds of non-rechargeable AA batteries (zinc, etc)

Higher quality batteries will give you longer boost times, cheap or dead batteries are the leading cause of 'flaky' behavior so be sure to get good batteries.

Don't "mix" dead and non-dead cells, or different kinds of cells. If you buy 2 batteries

in a pack, keep them together. This will get you the best performance.

Rechargeable AAs

You can use rechargeable batteries in the Mintyboost, as well! Here in approximate order of effectiveness, are the rechargeable batteries you will want to use:

1. High-capacity (~2500mAh), high quality NiMH batteries (See the standard in testing, the [NiMH shootout \(!\)](#))
2. Eneloop
3. Non-brand medium capacity NiMH batteries (See the standard in testing, the [Ni MH shootout \(!\)](#))
4. NiZn batteries (? We haven't actually tested these so we are not 100% sure if they perform well but they should be OK)
5. NiCad batteries

Good quality NiMH batteries work fantastic, but be careful of using really old cells. Don't "mix" dead and non-dead cells, or different kinds/brands of cells. If you buy 2 batteries in a pack, keep them together, and charge/use them at the same time. This will get you the best performance.

Alkaline or rechargeable?

Which is better? Well, that's a question that depends a lot on the battery quality. In general we always suggest rechargeables as they are less wasteful and are not much more expensive. However, sometimes you're in a bind or need the light weight of Lithium AAs. Either type will do fine, but try to stick to #1 thru #3 in the preferences above.

The tradeoffs are:

- Alkaline batteries are available everywhere, don't need to be charged before use, can be less expensive
- Alkaline batteries have a higher 'nominal voltage' of 1.5V so they provide more power just because of the voltage increase
- NiMH are very good at providing a lot of current, often better than Alkalines (although perhaps not as good as Lithium 1.5V cells)

- NiMH cells other than Eneloop and similar 'low self discharge' will slowly run down even when just sitting around

Because the run time completely depends on how the device charges, what its battery size is, etc, nothing beats timing and testing the first time you use the Mintyboost to charge your device.

Bigger batteries? More batteries?

Let's say you want more power out of your mintyboost - the best way to do this is to upgrade the batteries from AA to something beefier!

Let's start with alkalines. Please refer to this Duracell alkaline battery capacity chart:

PRODUCT NUMBER	SIZE	NOMINAL VOLTAGE		RATED CAPACITY*		LOAD		WEIGHT		VOLUME		TYPICAL GRAVIMETRIC ENERGY DENSITY**		TYPICAL VOLUMETRIC ENERGY DENSITY	
		volts	ampere-hours	ohms	pounds	kilograms	cubic inches	liters	watt-hours per pound	watt-hours per kilogram	watt hours per cubic inch	watt hours per liter			
MN1300	D	1.5	15,000	10	0.304	0.138	3.440	0.056	59.2	130	5.2	322			
MN1400	C	1.5	7,800	20	0.143	0.065	1.640	0.027	65.5	144	5.7	347			
MN1500	AA	1.5	2,850	43	0.052	0.024	0.510	0.008	65.8	143	6.7	428			
MN2400	AAA	1.5	1,150	75	0.024	0.011	0.230	0.004	57.5	126	6.0	345			
MN9100	N	1.5	0,800	100	0.021	0.010	0.210	0.003	45.7	96	4.6	320			
7K67	J	6.0	0.580	340	0.075	0.034	0.960	0.016	37.2	82	2.9	174			
MN908	Lantern	6.0	11,500	15	1.349	0.612	30.620	0.502	40.9	90	1.8	110			
MN918	Lantern	6.0	24,000	9	2.800	1.270	75.880	1.243	41.1	91	1.5	93			
MN1604	9V	9.0	0.580	620	0.101	0.046	1.390	0.023	41.4	91	3.0	182			

* TO 0.8V per cell at 21°C (70°F).

** Based on 1.2 volt average operating voltage per cell at 21°C (70°F).

Table 1. Comparison of typical energy densities of major DURACELL® alkaline cells/batteries.

For example, upgrading a set of Duracell AA's (2850 mAh) to C (7800 mAh) or D cells (15000 mAh!) will increase the capacity 3x (C) or 5.5x (D) !

If you want even MORE power, you can add a third battery in series to increase the input voltage from 3 volts (2 x 1.5v) to 4.5 volts. Three AA Alkaline batteries has approximately 1/3x more power than 2 Alkaline AA's, three C's have 4x as much capacity as two AA's, and three D's have 7.5x more capacity.

However, there is a limit to how many more batteries you can add. For example, after 3 Alkalines, one would think you should go for 4. But 4 Alkalines is 6V nominal (and actually may be as high as 7V) - since this is higher than the 5V output, it is not safe or good for the mintyboost or your device. For that reason, use only 2 or 3 alkaline batteries, not 4!

OK, now what about rechargeable AA's? First thing to remember is that rechargeables C or D cells may not have more capacity. Sometimes they are really AA batteries in a large plastic shell! Assuming that you can get real rechargeable C or D cells, you should be able to get 3x or 5x more capacity just by going with bigger batteries.

The other option is to add more batteries in series. You can definitely go with three NiMH cells, which will boost power by 1/3 and as long as you are using NiMH/NiCad rechargeable you can also try 4 AAs. Because NiMH cells do not run at 1.5v (they run at 1.2v or so) four cells will be under 5 volts. Of course, do not use 5 or 6 AA's as that will go well over the 5 volt limit.

Lithium Ion Polymer

If you are an advanced electronics geek and want an ultra light rechargeable mintyboost you may be thinking about going with a lipoly or liion battery. The Mintyboost works great with these, but be sure to watch for the following:

1. Use only single lithium ion polymer cells - 3.7 to 4.2v. Don't use 7.2v-8.4v cells! those are way too big.
2. Use only lithium ion/poly cell with a protection circuit. The mintyboost draws a lot of current and will drain the battery all the way down, unprotected raw cells will almost certainly be damaged, either bursting, catching on fire, leaking fluid, etc. Really, we mean it!
3. Use only a proper recharger for the cells, lithium ion/poly's are delicate and cannot be charged in a NiMH charge.
4. Do not parallel lithium polymer cells on your own. Power packs come with a 'balancer' circuit that must be used to keep them from discharging into each other.

Basically, don't start noodling around trying to invent your own lithium polymer cell pack!

How many recharges will I get?

This completely depends on what kind of batteries are in the mintyboost and what kind of battery is in your device. Both are energy buckets, but the size of the buckets will tell you if you can fill one with the other.

There are few things that make a difference:

- The first thing to keep in mind is that the Mintyboost converts power from low voltage to high voltage (5V) but it is not perfect, there is charging efficiency loss. The conversion efficiency can be approximated as 80% - it may be higher or lower but it's pretty close.

- The device battery capacity is mAh. (The mWh is not useful here, because the charger inside is linear.) If your gadget has a 1000 mAh battery inside, that tells you the size of the bucket you are trying to fill.
- The mintyboost battery capacity. For fairly good batteries, this is going to be about 2800 mAh.
- The fact that the most AA batteries you get have their capacity specified for low-drain use and this is high drain use. For alkalines you can probably consider the capacity to really only be 75% of what they say it is. For NiMH, maybe 80%, and for Lithium Polymer it's 100% (they are really good at this sort of thing).
- The mintyboost battery voltage. For alkalines this is 1.5, for NiMH its going to be less, 1.2V

Let's say we are using Duracell 1.5V Alkaline AA's.

First, figure out what the milliWatt-hours of the mintyboost power supply is:

$$\begin{aligned} \text{mintyboost mWh} &= \text{Battery voltage (V)} * \text{Battery capacity (mAh)} * \text{Capacity} \\ &\text{derating} \\ 2 * 1.5V * 2850\text{mA} * 75\% &= 6400 \text{ mWh} \end{aligned}$$

This is the battery's capacity. Next we calculate the milliAmp hours the mintyboost will output at 5V:

$$\begin{aligned} \text{Output mAh @ 5V} &= \text{Battery mWh (mWh)} / 5 \text{ (V)} * \text{Boost Efficiency} \\ 6400 \text{ mWh} / 5V * 80\% &= 1026 \text{ mAh output} \end{aligned}$$

This how much current it can provide, and for how long. Now divide this by the size of the battery it's charging. Say you are charging an iPhone 3G (which has a 1200 mAh battery inside):

$$\begin{aligned} \# \text{ of full recharges} &= \text{MB output mAh} / \text{Device Battery Capacity} \\ 1026\text{mAh} / 1200\text{mAh} &= 0.85 \text{ times} \end{aligned}$$

So, at best, two Alkalines can get you about 85% charged up (not more than one charge!)

Lets try again with Sanyo AA NiMH 2700mAh (the best NiMH batteries there are):

MintyBoost mWh = $2 * 1.2V * 2700mAh * 80\% = 5184$ mWh input
Output mAh @ 5V = $5184mWh / 5 * 80\% = 830$ mAh output
of iPhone 3G recharges = $830 mAh / 1200 mAh = 0.70$

These batteries will give you 70% charge up. Less than Alkalines because the nominal voltage (1.2V) is less than Alkaline (1.5V)

Finally, lets do a 1200mAh lipoly battery with 3.7V nominal voltage:

MintyBoost mWh = $3.7V * 1200mAh * 100\% = 4440$ mWh input
Output mAh @ 5V = $4440mWh / 5 * 80\% = 710$ mAh output
of iPhone 3G recharges = $830 mAh / 1200 mAh = 0.60$

These batteries will give you 60% charge up on your iPhone.

Note that these calculations will give you a reasonable approximation and an upper bound. As the batteries age, their capacity decreases. The internal charger of whatever you're charging may also not be 100% efficient. Keep this in mind but don't be surprised if it's an 'upper limit.'

Detailed guidelines - Voltage Requirements

The Mintyboost converts a low voltage to 5V USB standard. Because of this the first thing you must be aware of is that you cannot put a higher than 5v battery on the inputs to the circuit. If you do, it could damage the kit. So make sure your battery unput is always below 5V. Do not use 9V batteries under any circumstance!

Another important thing to realize is that the chip inside the MintyBoost also has a minimum voltage requirement, which is 2V. So do not try to run it off of a single AA battery or similar.

Your best bet is to keep the battery input between 2V and 4.5V. Under 2V, the chip won't work, above 4.5V the chip becomes less efficient (for extremely technical reasons that we won't go into right here) and above 5V it will not be able to keep the voltage at a steady 5V.

Detailed guidelines - Current Requirements

Many devices now charge at 500mA or higher rate, which translates into a 1000 mA draw from the batteries (because the voltage is boosted, the current is also boosted!)

Getting batteries with low internal resistance and high mAh capacity is key.

Try to aim for at least 2000mAh capacity of your 1.5v batteries. For Lithium ion/poly 3.7v cells, 1000mA or higher is good as well. Larger capacity batteries also have a positive side effect that they don't droop or sag as much under high loads and have lower internal resistance!

Tons of info!

- [Sanyo NiMH and Eneloop capacity info \(\)](#)

Compat v3

Device Compatibility list for v3

Verison 3 mintyboosts!

This compatibility list is for the version 3.0 of the mintyboost, which uses the LT1302 charger chip and has 4 resistors for improved iPhone compatibility. Basically, If you got it after August 2010, it's probably v3 - but check the kit packaging to be sure!

The following tables contain the current known tested devices and results. We are pretty sure that [every device that worked with the MintyBoost v2 \(\)](#) will work with the v3 in addition to all the Apple devices. However, we don't own every gadget in the world (that would be neat but expensive!) so if you find a device that works, please let us know by [contacting us \(\)](#), [posting in the forums \(\)](#) or sending Feedback. Thank you!!!

Apple Products

Product name	Results	Battery Size
iPhone 5, 5s and 5c	Works	
iPhone 4s	Works	
iPhone 4	Works	1400mAh
iPhone 3Gs	Works with most	1200mAh

iPhone 3G	Works	1200mAh
iPhone	Works	1400mAh
iPod Video 5G	Works	450-850mAh
iPod Nano 3G	Works	
iPod Nano 5G	Works	220mAh
iPod Nano multi-touch	Works	
iPod Touch 3G	Works	
iPod Touch 4G	Works	
iPad	Doesn't work	6800mAh

HTC

Product name	Results	Battery Size	Notes
T-Mobile G1 (Google Dev Phone 1, HTC Dream)	Works	1150 mAh	
HTC Droid Eris	Works		
HTC Legend	Works with v2	1300mAh	
HTC Magic	Works V3.0		
HTC One S	Works V3.0		
HTC Desire A8183	Works	1400mAh	
HTC Evo	Works	1500mAh	
HTC Droid Incredible	Works V3.0		
T-Mobile G2 (HTC Vision, HTC Desire Z)	Works	1500mAh	Detects as "USB Charger" (Trickle charger)

HTC Hero GSM	Works	1350 mAh	
T-Mobile MyTouch 4G	Works	1400 mAh	
HTC Thunderbolt 4G (Verizon)	Works V3.0 - USB Spec	1400 mAh	~600 mA charging with 3 NiMH cells
HTC Velocity 4G (Telstra)	Works	2 x Sanyo AA eneloops	

LG

Product name	Results	Battery Size	Notes
LG Ally	Works	1500mAh	Will light up and claim to be charging, but won't actually charge without the data lines shorted.
LG CF360	Works		
LG Nexus 4	Does not work		Will light up and claim to be charging, but won't actually charge with or without the data lines shorted.
LG Optimus S	Does not work	1500mAh	Short the two data lines together and it seems to recognize it as charger. After 20 minutes, "percent charged" increased, but by morning, both phone and MB3 batteries were dead.
LG Env3 Verizon	Works	950mAh	Standard build.
LG GD510POP	Works	900 mAh (3.4Wh)	Standard build.

Motorola

Product name	Results	Battery Size	Notes
--------------	---------	--------------	-------

Atrix	Works*	1930 mAh	V3 tested only *Some reports excessive current draw and overloading the MintyBoost - as well as other chargers.
Backflip	Works with Mod	1150 mAh	Short the two data lines together (see last image of instructions) May need to remove R2 and R4
DROID	Works		
DROID RAZR MAXX	Works	Non-removable Li-Ion 3300 mAh	V3 tested only
DROID X	Works	1500mAh(min) 1540mAh(typ) 5.6 Wh(min) 5.7 Wh(typ)	
Milestone	Works with Mod		Requires LiPo/Lilon or 3 AA battery input

Samsung

Product name	Results	Battery Size	Notes
Captivate	Works	1500 mAh	
Vibrant	Works	1500 mAh	
Moment	Works		
Galaxy S2 16GB GT-I9100	Works	1650 mAh	
Galaxy S3	Works	7.98 wH 3.8 V Lilon	Tested v3 - no need to short data lines

Galaxy S3 i747 AT&T	Works		Would claim to charge with standard build, but had to short data lines for it to work. CM10 ROM
Samsung Galaxy I7500	Works	1440 mAh	
Samsung Galaxy Nexus	Works	1850 mAh	Tested v3

Sony Ericsson

Product name	Results	Battery Size	Notes
W580i	Does not work	930mAh	V3 detected as PC, also after blobbing together the middle USB pins. Charging shown on screen only when phone switched to PC (flash storage, offline) mode. But after 3 hours no change in battery status. 2X2300 NiMH AA used, 1.32V on each also after 3 hours
Xperia Arc	Works	1500 mAh	
Xperia Ray	Works	1500 mAh	

Nokia

Product name	Results	Battery Size	Notes
N97	Works	1200mAh	Modified a v2 kit to V3 now charges fine
lumia 820	Works	1650mAh	v3 kit-data terminals not shorted

RIM

Product name	Results	Battery Size	Notes
Blackberry Storm	in progress		needs 2 volts, need to modify MB 2.0 to 3.0 specs
BlackBerry Tour 9630	Works	2300 mAh	Standard build.
BlackBerry Bold 9900	Does Not Work	1230 mAh	Shorting the data lines may show as charging but this does not seem to be the case.

More Phones!

Product name	Results	Battery Size	Notes
ZTE BLADE (aka orange/mobistar San Francisco)	Works	1250 mAh (4.7Wh)	Standard build.

eBook Readers

Product name	Results	Battery Size	Notes
Kindle	Works	1500mAh	
Kindle DX	Works	1500mAh	
B&N Nook 1st Ed.	Doesn't work	1530mAh	Orange, I have power light, turns on, but charging indicator does not, and unit does not charge.
B&N Nook	should	1500mAh	doesn't require USB spec for charging and worked with bare batts.

Handheld Games

Product name	Results	Battery Size	Notes
--------------	---------	--------------	-------

PSP Slim (2000, 3000)	Works	1200mAh	Charge with the DC barrel connector, not USB
PSP (1000)	Works	1800mAh	Charge with the DC barrel connector, not USB
NDS Lite	Works	1600mAh	

MP3 Player

Product name	Results	Battery Size	Notes
Zune HD	Works	660mAh	

Compat v2

Device Compatibility for v2.x Mintyboosts

For version 2.x only!

This compatibility list is for the v2 of the mintyboost, which uses the LT1302 charger chip but does not have the special iPhone resistors. Basically, if you got it before August 2010, it's definitely v2 or earlier.

Mintyboost Compatibility chart!

Turns out some devices don't like being charged with a battery pack, usually devices that require special drivers to charge. (Try plugging it into a random computer's USB port, if you need to install software to get it to start charging, you probably won't be successful.) Please post on the forum if you have more information on what works and doesn't! Thanks

Tested Works:

- Apple iPod: Mini, Nano rev 1G/2G/3G, Shuffle 1G/2G, Photo/5G/Video/Classic
- Read [Apple's identification guide \(\)](#) to see which one you've got, if you're not sure.
- Older Apple iPod Touch (v1), iPhone and iPhone 3G (with v2.0 of the kit) - These do work, but they're finicky. Check the FAQ and try 'Lithium 1.5V' batteries. Unfortunately Apple has made updates to the firmware and hardware to make it

harder for people to use "nonauthorized chargers." This has been fixed in v3 of the Mintyboost.

- Arcos 605 WiFi
- AT&T 8525 (a.k.a. HTC Hermes).
- AudioVox 6700 (use R5 as a pullup)
- Blackberry
- [BT-1 \(\)](#) bluetooth camera
- Cowon iAudio X5
- Creative Zen Micro (tested with firmware v1.11.01)
- Creative Zen Vision M (Doesn't work through USB but does work with a [DC connector/adaptor, as sold in the webshop \(http://adafru.it/23\)](#))
- Dell DJ Ditty
- Garmin Edge 305
- Garmin Forerunner 305 (unplug it when its done charging or it can drain itself!)
- Gigabeat S30 (Doesn't work thru USB but does work with a DC [connector/adaptor, as sold in the webshop \(http://adafru.it/23\)](#))
- GlobalSat's DG-100 GPS datalogger
- HOLUX GPSlim236 bluetooth GPS
- iMate Jam, iMate SP5 smartphone
- iPaq (5555 pocket pc)
- iRiver Clix u10
- iRiver E10 (use pulldown)
- [iRiver H340 \(\)](#)
- Locosys Technologies BGT-11 GPS
- LG enV2, VX9100
- M-AUDIO Microtrack 24/96
- Microsoft Zune
- MobiBLU DAH-1500i
- Motorola Quantico
- Mrobe 500 + 100 (with [adaptor cable \(http://adafru.it/23\)](#))
- Nintendo DS/GameBoy Advance (with [adaptor cable \(http://adafru.it/22\)](#))
- Nokia phones, using cables CA-70 and CA-100 will charge nearly all Nokia phones (except the 8600), also known as 'standard Nokia USB data/charger' cables
- [O2 XDA II \(http://adafru.it/22\)](#)
- Openmoko neo FreeRunner ([see here \(\)](#))
- Palm TX, Palm Tungsten T3, Palm Zire 71 and 72, Palm Pre
- PocketPC HX4700 (Go into the power settings and turn on charging through USB)
- Rio Carbon
- Samsung SCH-i730, SGH-i750, SGH-i858 ([With a USB charger cable \(\)](#), you can also [hack a cable yourself, see here \(\)](#)) SCH-U520

- Samsung T809
- Sandisk Sansa Express (use pullup resistor) [See notes here \(\)](#)
- Sony PSP (with [adaptor cable \(http://adafru.it/23\)](http://adafru.it/23))
- Treo 700p, 750 (using Palm's charge/sync cable)
- T-Mobile Dash (HTC Excalibur)
- T-Mobile Wing (or HTC Herald, or HTC P4350)
- T-Mobile G1 (google phone)

Tested Kinda Works:

- Motorola RAZR v3: doesn't work by default, requires a bit of cable hacking. See this document at [pinouts.ru \(\)](http://pinouts.ru) and this [fellow's graphic \(\)](#).
- Treo 600 (Says it isn't, but is. Won't charge more than 50% ?)
- Samsung D00 phone (Should also work: D800, D820, E780, E870, P300, P910, P920, T809, Z540) requires a [cable hack \(\)](#)
- Motorola H700 bluetooth headset (Kinda? Sorta? Unclear)
- BT-GPS1210 (SIRF III mouse) requires USB charging cable

Tested Doesn't work:

- Audiovox SMT 5600 Window Mobile phone (v1.2 works with the 6700 so it could be that this works now)
- 1-3G iPods (Firewire only!)
- iPhone 3GS, 4, iPod Touch v2 and other 2010+ iPhones. This has been fixed in v3 of the Mintyboost
- Sidekick LX2009 (one report)
- MuVo Slim (one report)
- Sony EBook reader
- Motorola Q (one report)
- Nokia 8600 phones require a driver to charge, so are unlikely to work.

Process

How to: How to

Meta Documentation

This page details how I went through the process of coming up with the idea, hardware, design, etc. for this project. It's not 100% correct but it's pretty close. Since this project only took 2 days (on & off) to design/test/release, it's a lot easier to keep track of than something enormous like the [x0xb0x \(\)](#).

This tutorial is quite old and the [Mintyboost has gone thru many revisions since then \(\)](#). We suggest that after you read this [you go on to read our "Apple Charging Secrets" tutorial which will take you from v1 \(here\) to the latest v3 \(\)](#).

Original Idea

OK so where does an idea come from anyways? It's the only important question & the most difficult. I guess I'd have to say it was prompted by looking at these half-dozen projects:

- [Aaron Dunlaps \(\) 9V USB charger](#)
- [Another 9V + 7805 USB charger \(\)](#) (Instructables)
- [Jason Streigel's 9V+7805 USB 'battery' \(\)](#) (hackaday)
- [Ians Firewire switching charger \(\)](#) (Instructables ())
- [Chris DiClerico's 9V+AA's firewire charger \(\)](#)

OK, there's probably even some I'm missing. So what's the overarching theme here? Almost all use 9V batteries and a 7805 (an extremely common linear 5V regulator: makes a solid 5V from 7-18V input). This design works great because, well, 7805's are awesome and 9V's provide 7-9V depending upon how 'dead' they are.

However, there's one thing about 9V's that I've learned (from lots of bad experiences). One is that they don't have a lot of amp-hours: that is, how much current (amps) they can provide and for how long (hours). A duracell 9V provides -about- 500mAh over its lifetime. That's 500 mA (or .5A) for one hour or 100mA for 5 hours. That number is somewhat idealized but it's a good starting point.

Another problem is that they don't like to supply a lot of current, because they have high internal resistance (~2ohms), but basically that just means that if you want a lot of current (say to resuscitate a drained device) the 9V won't provide all 500mAh, but maybe more like 400. (Say you're drawing 250mA, then $.25A * 2ohm = 0.5V$ lost to internal resistance. For more info on 9V, read the [duracell datasheet \(\)](#).)

Another problem with the 9V+7805 scheme is that a 7805 is a linear regulator. That means if you want 100mA at 5V (basically, USB power) then you're taking 100mA at 9V and then losing the $4V * 100mA = 400mW$ (.4W) difference as heat.

As the battery wears down to 7V the heat loss goes down to $(7-5V) * 100mA = .2W$ but you're still getting bad efficiency. At best the efficiency is 72% (5V/7V) and at worst it's 55% (5V/9V) That means you're losing about a third of the battery power to heat!

I'll also throw out that the 7805 itself has a quiescent current of about 5mA so you're always losing 5% (5mA/100mA) efficiency just for regulation! (& that's at least since if you're trickle charging the battery at 50mA then the 5mA quiescent is 10%)

OK so basically the 7805+9V solution works but the efficiency is startlingly low, say 60% or so, and provides only 300mAh at 5V.

We can engineer better!

Engineering better!

From experience, I know that AA's are great. They are cheap, have lots of power, very low internal resistance and are easily available everywhere. Whereas a 9V has 500mAh (for a total of $9 \times 500 = 4.5\text{Wh}$ power) two AA's have 3000mAh each for a total of $2 \times 1.5\text{V} \times 3000\text{mAh} = 9\text{Wh}$, about twice as much power. The only problem is that 2xAA's provide 3V and what we need is 5V. With a 9V battery we can use a linear regulator because $5\text{V} < 9\text{V}$ but, sadly, we cant use a linear regulator to turn 3V into 5V. Instead we will need to use a boost regulator (also known as a DC/DC switching/step-up regulator).

The process of how a boost regulator works is somewhat beyond the scope of this document, suffice to say they work great but are a little more annoying than linear regulators because you have to pick out an inductor and wire up some extra parts. You can get a lot more info about [Boost Converters at wikipedia \(\)](#).

Case in point

So at this point I start thinking about enclosure and size. Most people think of this last, and that's a bad idea. If there's one thing I've learned from hacking on electronics, it's that you should try and select the case first because it dictates a lot of the electronics and interface.

I know that the parts for the kit must be all through-hole (no surface mount) and easy to work with. I also want AA batteries, 2 is good although I know from experience that most boost converters will work with any number from 1 and 3 just fine. I have a predilection for Altoids tins and I also know that I can fit ~2 AA's into a gum tin so I pull out a tin and take some measurements:



The PCB-mount one seems to be pretty good, it doesn't have a switch but I don't need one anyway (see quiescent calculations, below).



So I take some measurements...



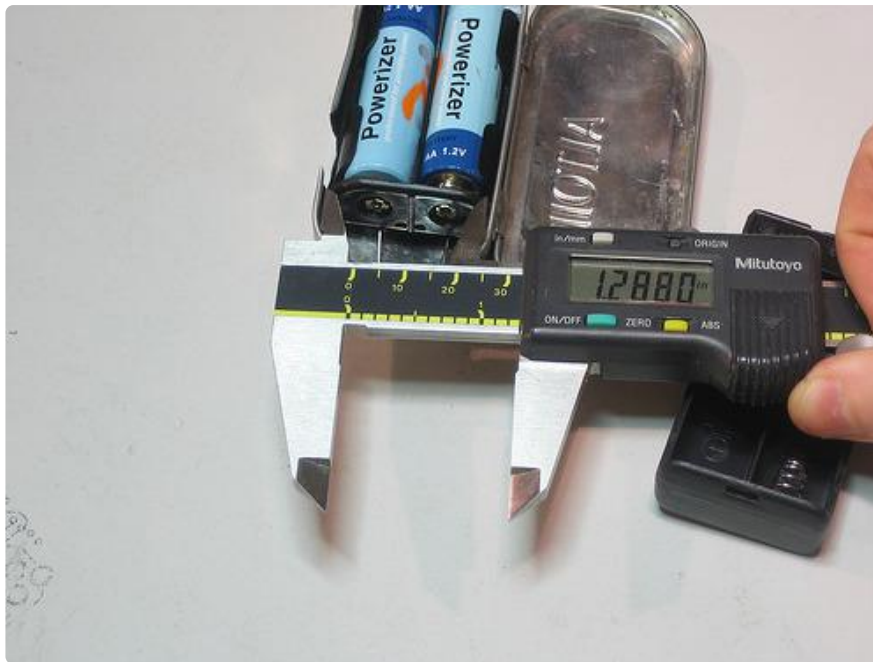

Looks like I have about 1.25" x 0.7" semicircular PCB space at the top for the circuit board.

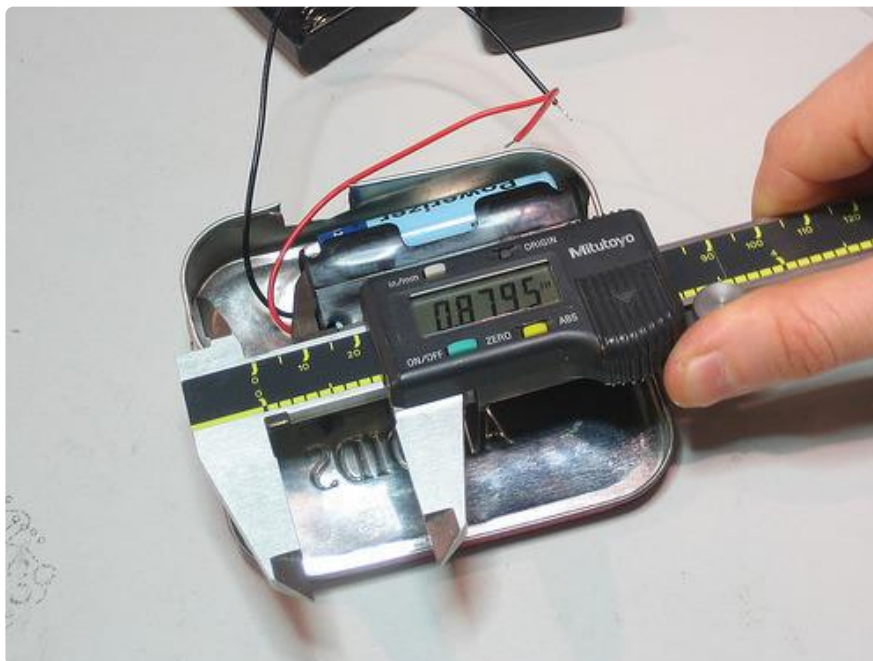

I also try out another battery holder I have, this gives me more space, 1.25"x0.85"...but the batteries go in sideways so one would have to remove the holder to change the batteries. I'd prefer that you can just take them out directly, so I don't go with this one (it also turns out I don't need that extra space).

I now do a little hack to turn the PCB mount 2xAA battery holder into a wire-lead one. Like this product photo (for "HOLDER BATTERY 2CELL AA 6"LEAD" from Digikey).

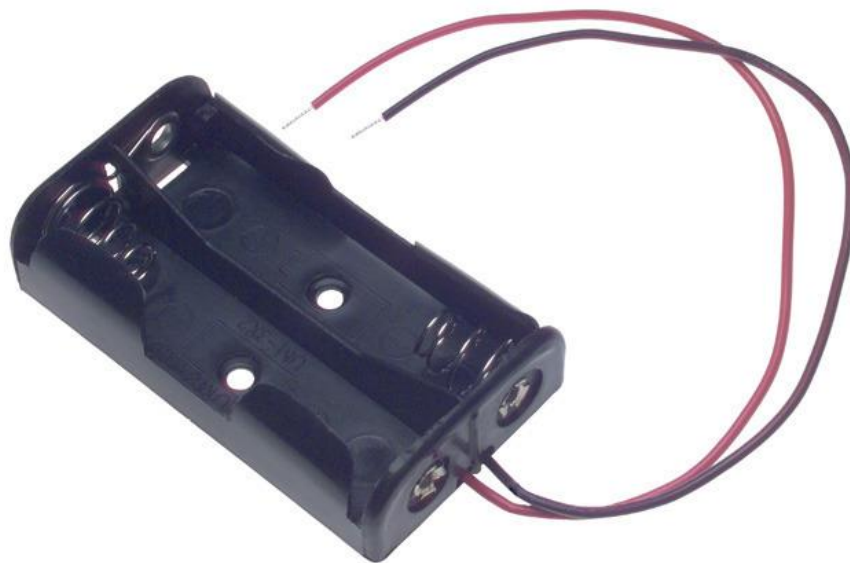

Basically I just solder on red and black 6" wires and clip off the PCB through-hole leads. This is actually a little difficult because the plastic melts and you have to sort of keep it in place while you solder. Its not suggested :)

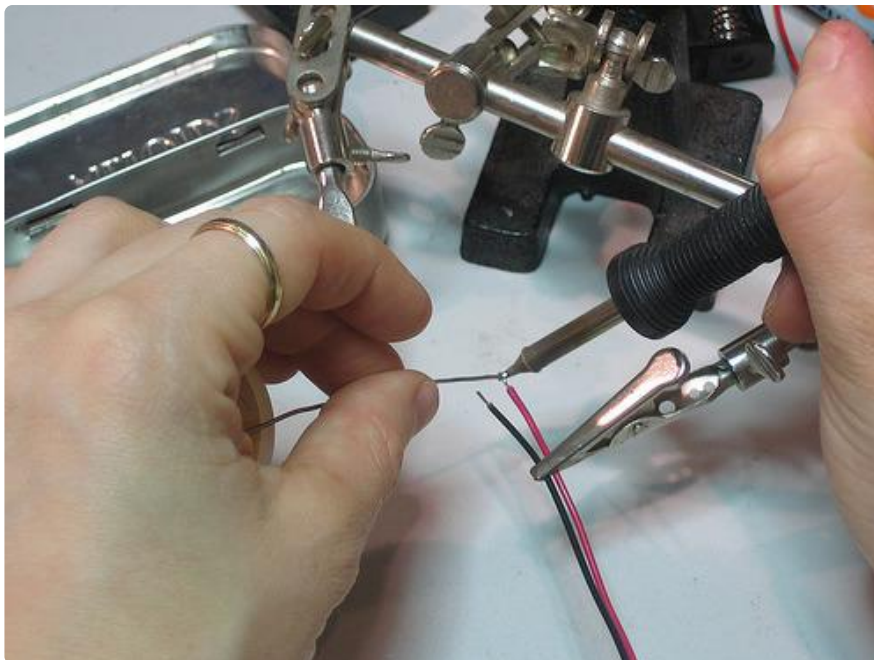

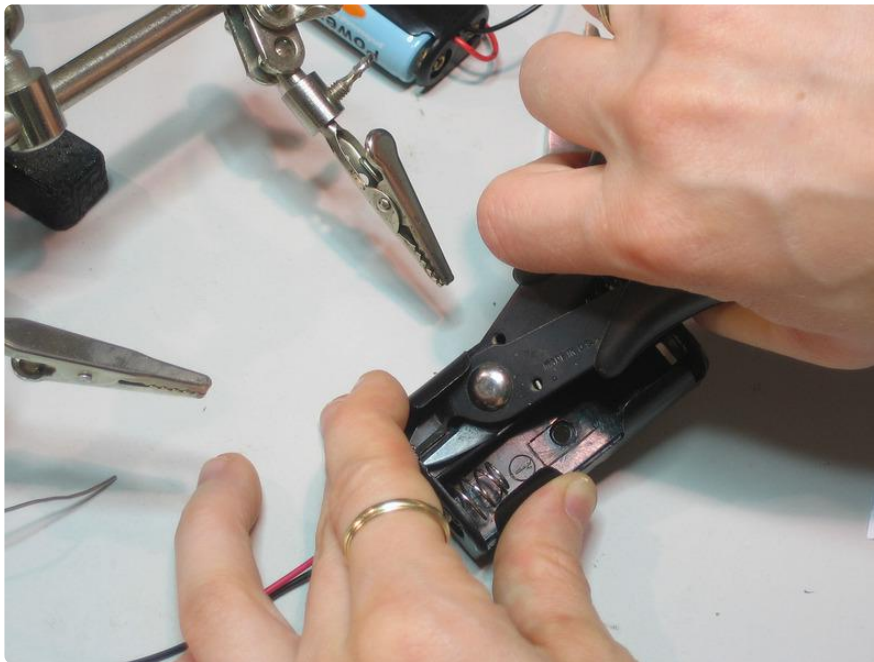

OK looks good.



Now that's done I'm ready to think about what I can cram into that space.

Basic Boost

So now it's time to design the boost supply. Since I don't have much space, I'm going to try to make my circuit as tiny as possible but still be easy to solder. That means I want a boost chip that is 8-DIP (smallest through-hole), with an internal MOSFET switch (1 less part) and is high frequency (to keep the inductor small). I also need to be able to supply 100mA at 5V and it should run on as low as 2V input. Also I want to be able to buy it online from a common supplier.

1. 8-DIP package
2. Internal FET switch
3. 100mA output @ 5V
4. 2V minimum input voltage

OK, lets search Digikey. I start with "DC/DC converter 8-DIP" and check "items in stock."

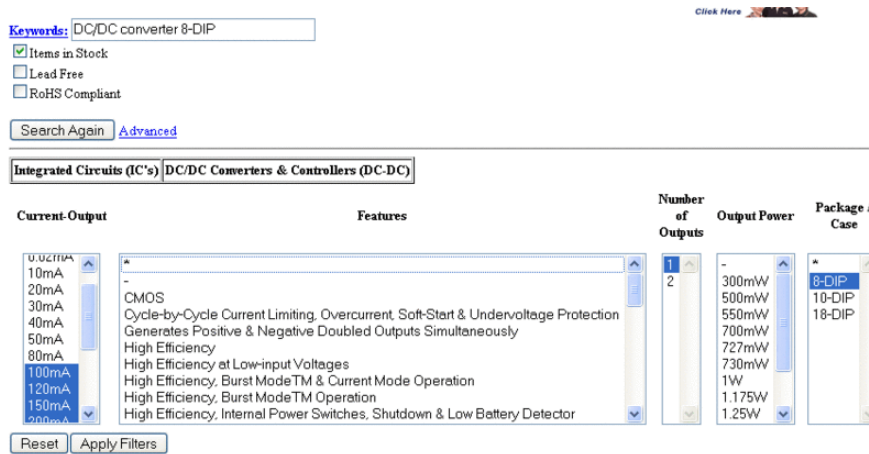

I then select 1 output, 8-DIP (to differentiate between 18-DIP) and select all the current-outputs $\geq 100\text{mA}$ and apply the filter. There's still about 40 options. So then I select the all voltage input ranges that start with 2V or less. Also I select all the Adjustable, and 5V-inclusive output voltage options.

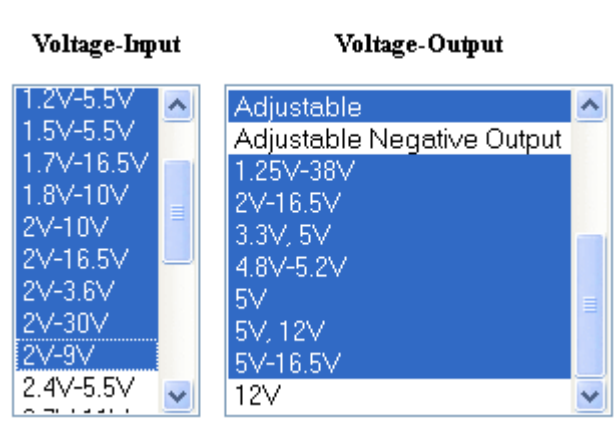

Looking over this list, it looks like I have a lot of options so I'm going to go back and select only the chips that can be preset to 5V (as opposed to adjustable ones that use 2 resistors to set the voltage). 5V is very common so every reasonable DC/DC chip will be available with such an option.

Now there are about a dozen options. The LT1073, LT1111, LT1173 and LT130x as well as the MAX751 & MAX756. They're all pretty much the same, so I basically make my choice based on price at 100 pieces (since I'm planning to kit it up). I also know that Maxim is great about sending samples so I decide to go with the MAX756 ([datasheet](#) ()) which is \$2.32/100. Note that I could have gone with any of them, so this a somewhat arbitrary choice.

According to the datasheet, I can supply up to 200mA @ 5V, run off input voltages as low as 0.7V and the efficiency is about 85% with 2 AA batteries. The chip also runs at 500KHz which is pretty fast and means that the inductor can be pretty small (~22uH)

Anyway, I've used this chip before and it's worked out well for me.

Inductive reasoning

The next step is to choose an inductor. This can be a bit of a pain, and there is a lot of math you can throw at the problem. However, the datasheet suggests (under "inductor selection") to get a 22uH inductor, with a ~1.2A saturation limit, and DC resistance of 0.02 ohms.

What we want is through-hole, which actually means it's going to be hard to find an inductor; almost all inductors are surface mount. But I'll take a look at what digikey has to offer. I search for "fixed uH inductor ~smd ~smt" which means I don't want SMT/SMD (surface mount) and I want a non-adjustable inductor that is in the uH range (not mH or nH). I then filter out inductors with 1-3A current and 18-27uH inductance.

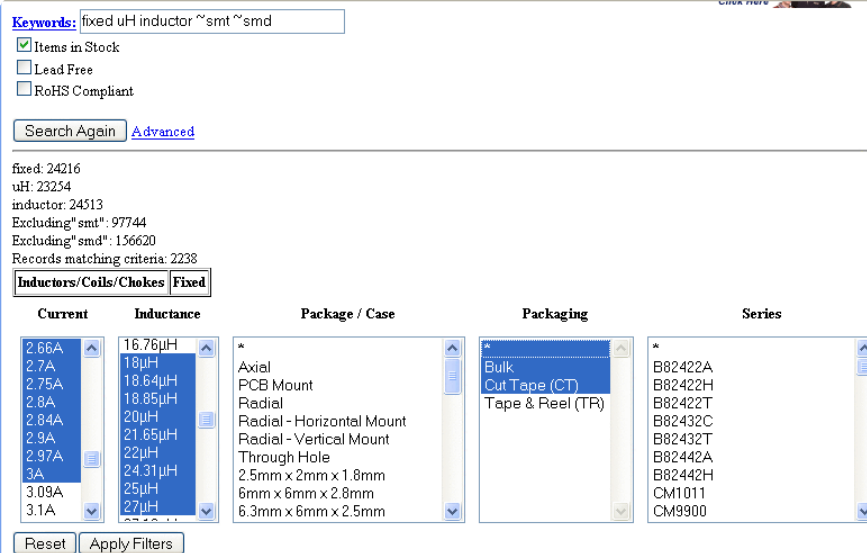

Current	Inductance	Package / Case	Packaging	Series
2.66A	16.76uH	Axial	Bulk	B82422A
2.7A	18uH	PCB Mount	Cut Tape (CT)	B82422H
2.75A	18.64uH	Radial	Tape & Reel (TR)	B82422T
2.8A	18.85uH	Radial - Horizontal Mount		B82432C
2.84A	20uH	Radial - Vertical Mount		B82432T
2.9A	21.65uH	Through Hole		B82442A
2.97A	22uH	2.5mm x 2mm x 1.8mm		B82442H
3A	24.31uH	6mm x 6mm x 2.8mm		CM1011
3.09A	25uH	6.3mm x 6mm x 2.5mm		CM9900
3.1A	27uH			

That filters it down to about a dozen choices. The SLF inductor is actually surface mount, and we're going to outright ignore the ones that cost more than \$2.50. Inductors for small electronics like this should cost around \$1-\$2, as a guideline. That leaves us with the DN7418-ND "INDUCTOR 27UH POWER AXIAL" and the 6000-220K-RC "INDUCTOR HI CURRENT RADIAL 22UH." Both of these look good, with about ~1.5A saturation current and 0.07 ohm DC resistance.

I also check out [Mouser](#) (). The online search for mouser isn't as nice as Digikey's so I end up looking at the paper catalog instead. I only found one inductor, really, the 18R223C (22uH radial power inductor) and/or the 18223C (axial version) that also has plenty of power capacity and a 0.03ohm DC resistance.

So, order 2 of each of these.

Rapid prototyping #1

In reality, what I did was look through the Digikey catalog, where I only found the DN7418 inductor (the other one was somewhat hidden in the RF inductor section). And it showed up before the Mouser box, so I spent an hour or two making up a prototype.

The circuit itself is simple, I want one large electrolytic cap for low frequency smoothing on the battery, and an output cap pair (electrolytic and one ceramic cap for high freq. smoothing). I also need the chip, a reference voltage capacitor, the inductor and a schottky diode to finish off the boost regulator. I happen to have some 1N5818's, which are often used as schottky diodes in boost regulators. I also need a USB type A female jack, of course, and two holes to solder the battery pack into.

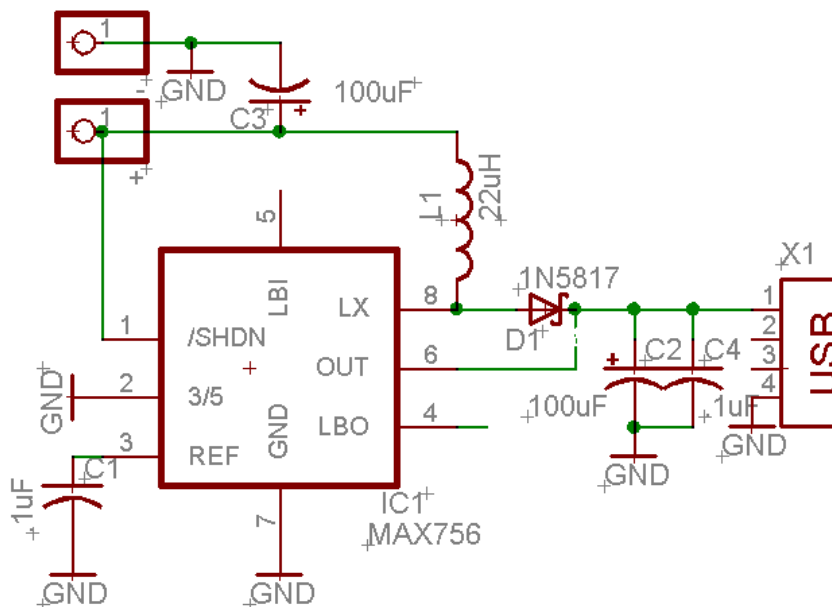

All these parts must fit into the space left over from the battery pack. I make EagleCAD library parts for the inductor and chip (the rest are already there) and lay out the board. I'm not going to detail making library parts in eagle or pcb layout, others have done so already. Use whichever software you want, I like Eagle because there's a free version available for download if you're just making small PCBs.

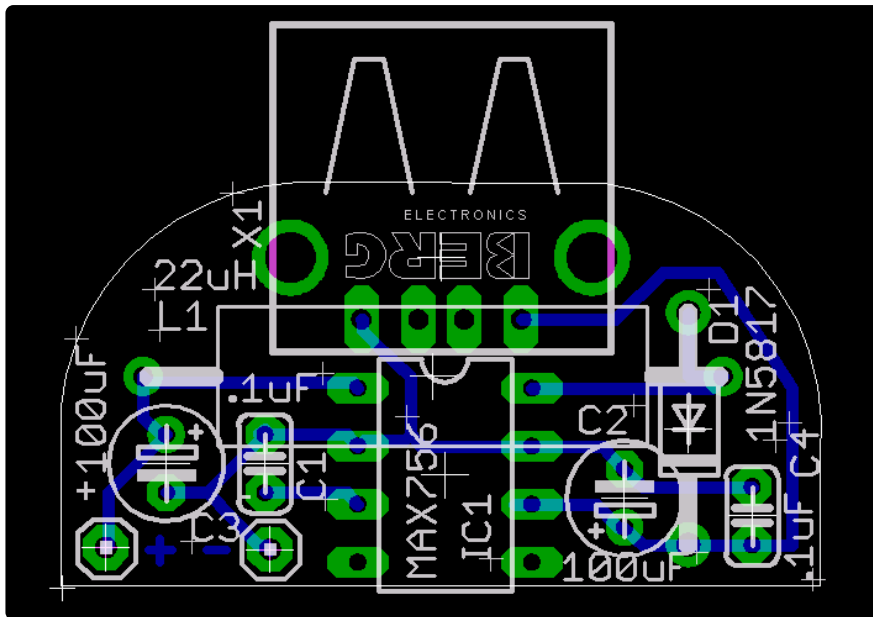

Since I am know this is just a prototype version, I make the PCB single sided -- for easy etching. I also make the traces really large.

I print out a paper version of the PCB and punch the parts through to verify that they're the right shape/package.



I get my etching setup together, turn on the heater for the etching tank, and print out a bunch of tiled PCB layouts on toner transfer. I transfer the toner onto a single sided PCB and etch it in the tank.

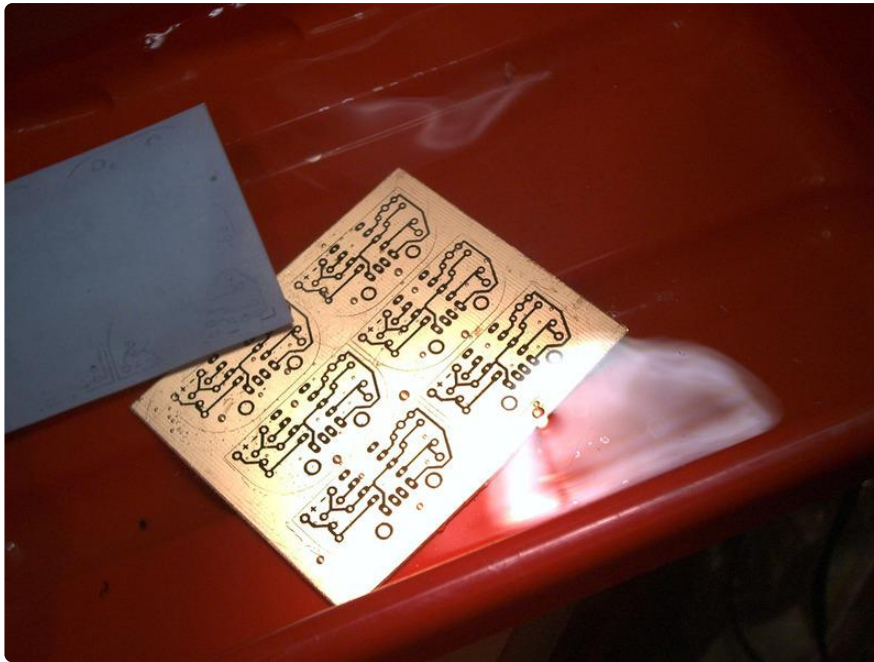

Then I clean off the toner transfer, drill the holes with a dremel drill-press with carbide drill bits, and cut out the shape.



Then I solder the parts in, and fit it into the case with the battery pack, using double-sided foam sticky tape to hold down both the battery holder and the PCB without shorting the PCB to the metal tin.

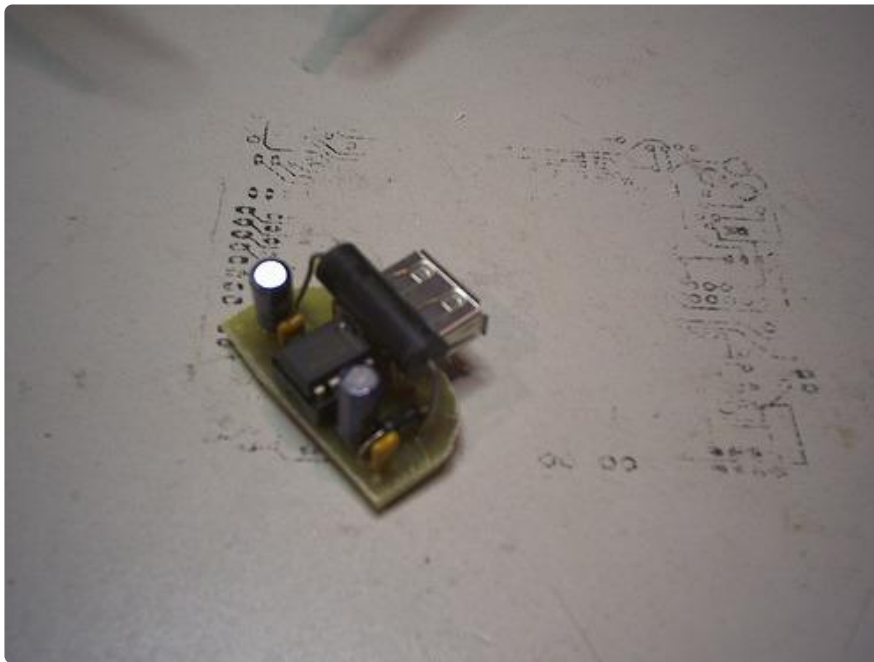

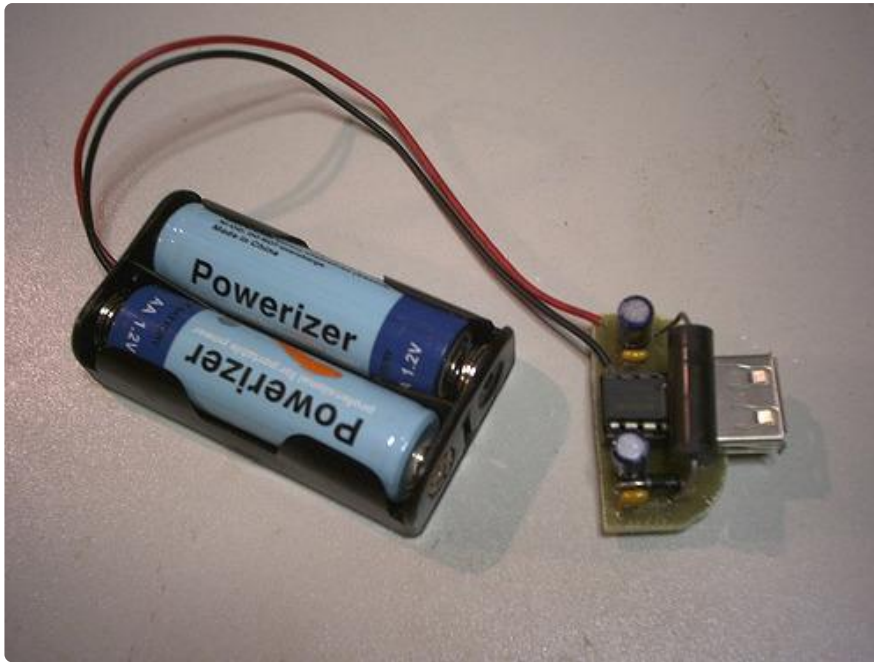

Done!



Testing the prototype

Now we test to see if it works! With the two batteries inside, I measure the voltage on the USB connector: about 5V, which is good. I send off this version to a friend with one of each kind of iPod, including the newest 4G video iPod, for real-world testing: Both to verify the iPod will charge and also how long it will run with the additional pack.



Numbers as soon as the QA dept gets them back to me...

Verifying the math

So, in theory, we should be able to calculate the efficiency of the boost converter from datasheet info. We're basically boosting 2.5-3VDC -> 5VDC at around 50mA-100mA. Looking at the MAX756 datasheet, this is the efficiency graph:

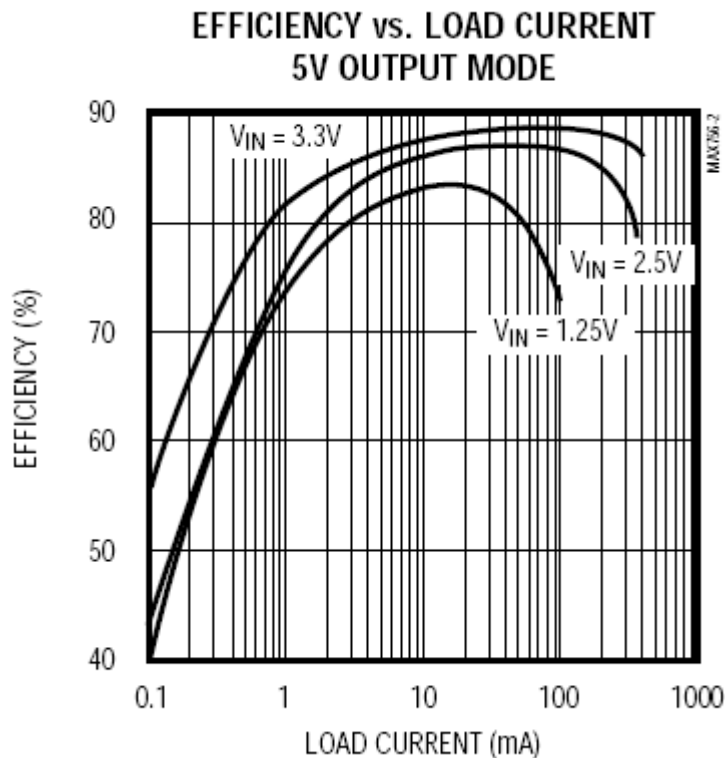

So we should be getting around 85% efficiency, perhaps a little more. I think the only thing that can really change this number a bit is the inductor. (Below, I verify I'm getting 82% efficiency)

If we're getting 82% efficiency conversion from 2 x 3000mAh Duracells, that means we get $(2 * 1.5V) * 3000mAh * .83 = 7.38$ Watt hours. Compare that to a single 9V as we calculated before: $(1 * 9V) * 500mAh * .65 = 2.93$ Wh. So we're going to get about 2.5x more power out of these two AAs than a single 9V. With rechargeable batteries, we get $(2 * 1.25) * 2200mAh * 81\% = 4.45$ Wh (about 50% more than an alkaline 9V and 3x more than a rechargeable 9V)

Next, lets verify the efficiency using test equipment, and try out the different inductors to see if they make a difference. Instead of using batteries, I'll provide 3V from a bench supply that will also tell me how much current is being drawn. And instead of an iPod I'll fake the load with a resistor. Since the standard USB current draw is 100mA from 5V, that means I need a $5V/.1A = 50$ ohm load. I can't just use a tiny resistor because $5V * .1A = 1/2W$ and most resistors are $1/4W$. So instead I take two large 100ohm 'power' resistors, and twist them together. I also check the resistance to

verify that together they are 50ohms. I also find a 20ohm power resistor. This will allow me to not only test a 100mA load but also a 250mA load.

I perform 4 tests with 2 inductors: 100mA load for both 2.5V in and 3V in (rechargeable and disposable batteries) and 250 load for both. All the images are up on Flickr for viewing, here is one example one...inductor #1 (DN2474) with 100mA load and 2.5Vin.

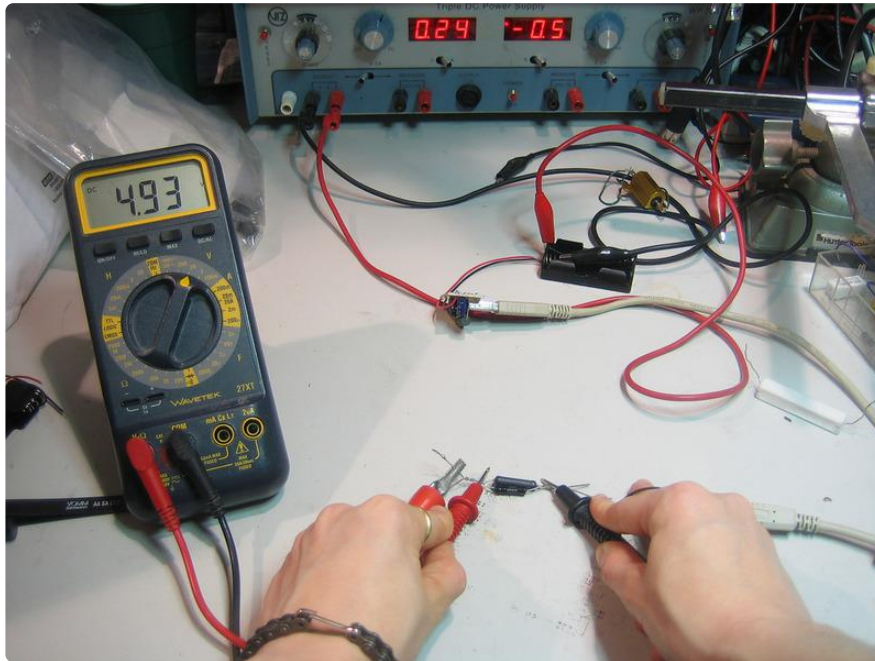

Here are my results, summarized:

DN2474	100mA/3Vin	100mA/2.5Vin	250mA/3Vin	250mA/2.5Vin
Vout	5.01	4.93	4.77	4.62
Iout (calc'd)	100mA	99mA	234mA	231mA
Iin	200mA	245mA	530mA	690mA
Efficiency	83%	80%	70%	62%

18R223	100mA/3Vin	100mA/2.5Vin	250mA/3Vin	250mA/2.5Vin
Vout	4.98	4.93	4.83	4.68
Iout (calc'd)	100mA	99mA	242mA	234mA
Iin	200mA	240mA	480mA	640mA

Efficiency	83%	81%	82%	68%
------------	-----	-----	-----	-----

It looks like inductor #2 is little more efficient, probably due to the fact it has a lower DC resistance (30 milliohms instead of 70mohm of the other inductor). It's also a bit cheaper so I'll go with that inductor.

Regardless, it looks like the efficiency is around 82% which is about what I expected.

Another thing to note is that I don't put an on/off switch in like you'd need with a 9V+7805 regulator. That's because the quiescent current of the MAX756 is very low, on the order of 100uA (0.1mA). I measured this myself and got about 75uA.

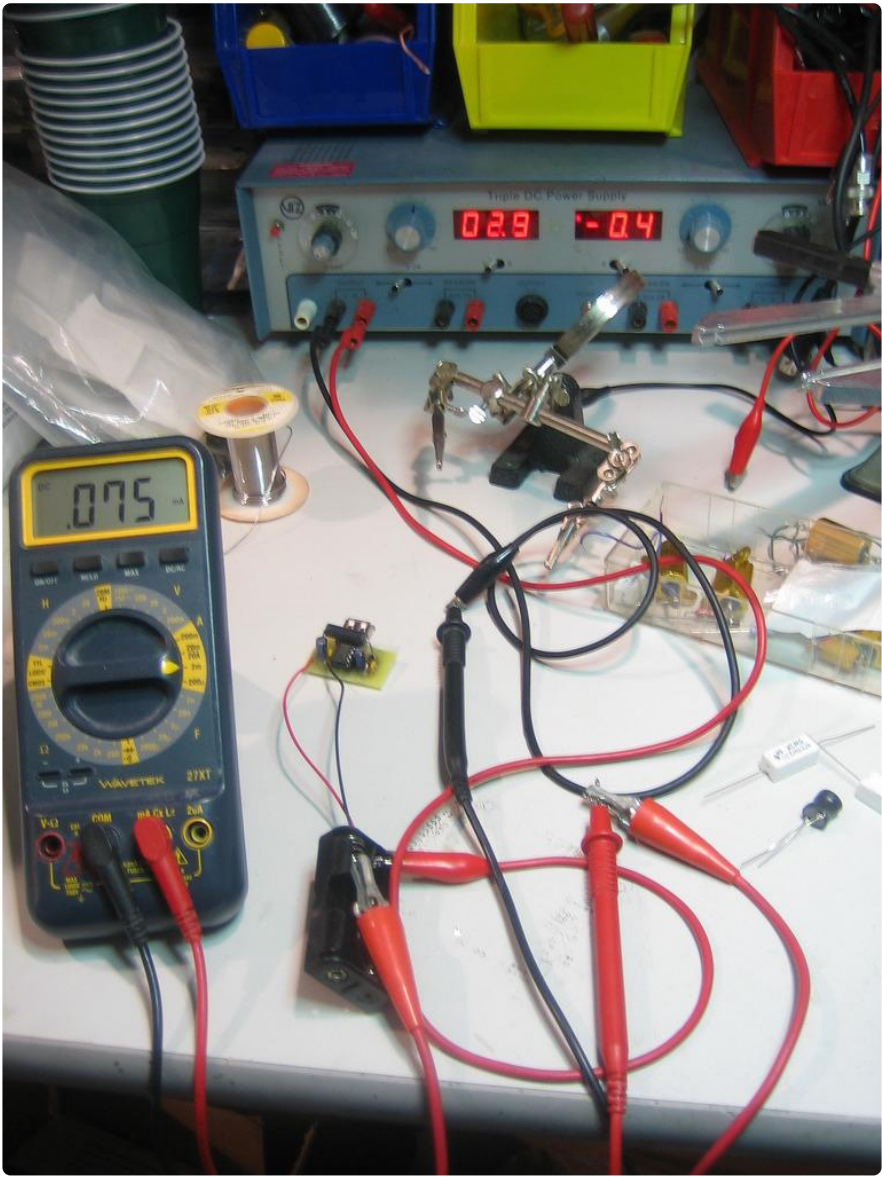

That means that the self-discharge rate is $\sim 2000\text{mAh} / 0.1\text{mA} = 20,000$ hours, more than 2 years. Most batteries don't last that long! Therefore we don't need a switch,

when nothing is plugged in, almost no power is being used.

Kit budgeting

So now that I've verified that the project works, I have to figure out whether I want to sell it, how many I expect to sell, and how much I want to charge. Lots of people have different techniques for this. I tend to go with my 'gut' which usually means there's a lot of information I use but it's difficult to express it.

I tend to decide whether I want to sell something based on how popular/useful/easy it is. I think that this kit will be pretty popular and useful because lots of people have stuff that charges/powers over USB. Also, it seems like other people are selling similar things (like the 9V + 7805 type charger, or [Griffin's 9V charger \(\)](#), or [Belkin's 4xAA charger \(\)](#)) It's easy to make because all the parts are through-hole and there's not a lot of them.

I'm going to basically assume I'll sell 200 or so within a few months, and I'll order parts in batches of 100, so I should budget that way. (I often buy more than 100 PCBs at a time because of the scale economies involved in PCB manufacture, as I show later.) It turns out so far that I can sell a couple hundred units of a kit in a few months, particularly if it gets picked up by a blog or web site. This may or may not be true for you, however if you can't afford to make 25 kits at once you're going to find that it's hard to make any money in the process.

To figure out how much to charge, I make up a table with different quantity prices:

Part	Price / 1	Price / 50	Price / 100
Boost chip MAX756	\$4.62	\$2.79	\$2.32
2 x 0.1uF caps	\$0.10	\$0.10	\$0.10
1n5818 diode	\$0.09	\$0.09	\$0.08
2 x 100uF caps	\$0.12	\$0.10	\$0.10
18R223 inductor	\$1.42	\$1.35	\$1.29
USB jack	\$0.52	\$0.35	\$0.32
AA holder	\$0.59	\$0.53	\$0.49
PCB	~\$12.50?	\$7.25	\$3.75

PCB tooling	N/A	\$3	\$1.5
Antistatic Bag	N/A	\$0.12	\$0.12
Sticky tape squares	N/A	\$0.10	\$0.10
Total	\$19.90	\$15.75	\$10.10

To calculate the PCB costs, I used [Advanced Circuit's \(\)](#) insta-quote service:

Production Price Matrix - Unit Price									
To Place Order: Click on unit price below									
Qty	Same-day	1-day	2-day	3-day	4-day Best Value!	1-week	2-week	4-week	
25	\$47.91	\$41.92	\$23.95	\$18.56	\$17.37	\$16.77	\$14.37	\$11.98	
50	\$24.76	\$21.66	\$12.38	\$9.59	\$8.97	\$8.66	\$7.43	\$6.19	
100	\$13.18	\$11.53	\$6.59	\$5.11	\$4.78	\$4.61	\$3.95	\$3.30	
Tooling NRE = \$150.00 (Tooling waived when reordered from proto)					Test = \$140.00 (Optional)				
Production Board Specs									
<ul style="list-style-type: none"> • Layers: 2 • 0.062 FR4 • Dimensions: 1.3" x 1.4" • Plating: Lead Solder • Cu Weight: 1 .oz min • Trace width/space: 0.01" • Smallest hole size: 0.024" • Plated Slots: No 			<ul style="list-style-type: none"> • Gold Fingers: None • SMDs-top: 0 • SMDs-bottom: 8 • SMD Pitch: 0.05" • Soldermask: Both Sides with LPI • Soldermask Color: White • Legend: Top Side • Legend Color: Black 			<ul style="list-style-type: none"> • Counter Sinks: No • Counter Bores: No • CNC Route points: 10 • Tab Route: No • Scoring: No • Plated Edges: No • Tolerances • Inspected to IPC-A-600G, Class 2 			

These prices are for 2 PCBs, which I'll cut in two, because it's cheaper (probably because they don't like dealing with very small circuit boards). I usually go with 2 week turn prices. Note that the PCB quote doesn't include the \$150 one-time tooling NRE fee, which adds \$3 to the /50 price and \$1.50 to the /100 price. Advanced Circuits is a little expensive, but they're very good on quality and they're good at catching mistakes. Anyways, you can try going with a cheaper shop but I can only vouch for these guys.

There's also shipping prices included, maybe \$1/per. In general, I double the parts cost to come up with the 'retail' cost. In this case, I'll charge \$19.50. Anything less than \$10 or \$20 is great because \$20 are considered to be stuff/food coupons, really.

Finishing up

There's a bit more work to do. First, I redesign the board since I'm going with a radial inductor instead of an axial one:

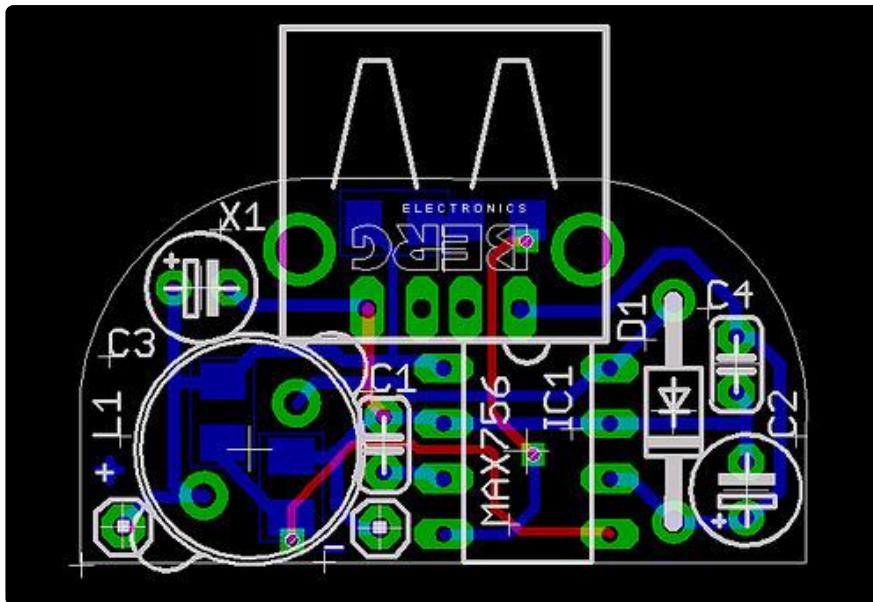

I actually do another etch test, to verify everything one last time. Then I tile two boards together (cheaper) and generate gerbers.

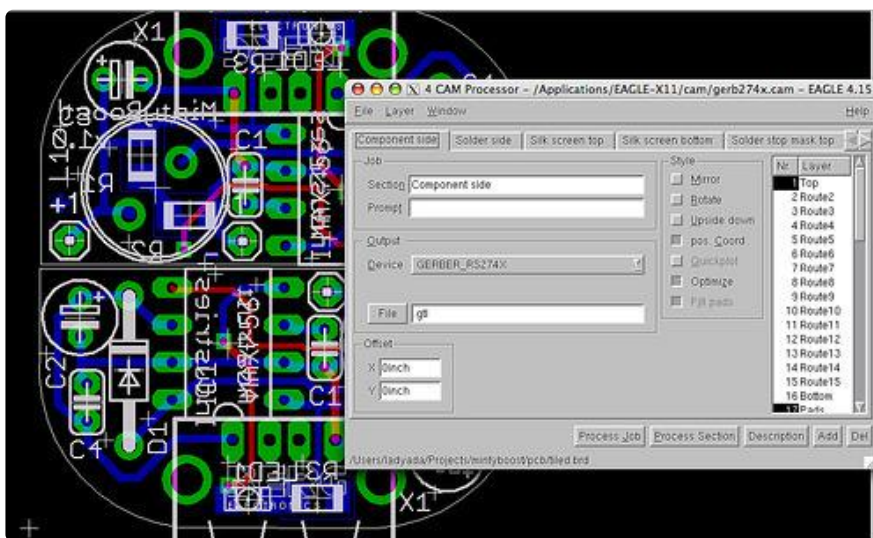

I use gerbv (free software) for viewing and verifying the gerbers. On windows, I use GC-prevue.

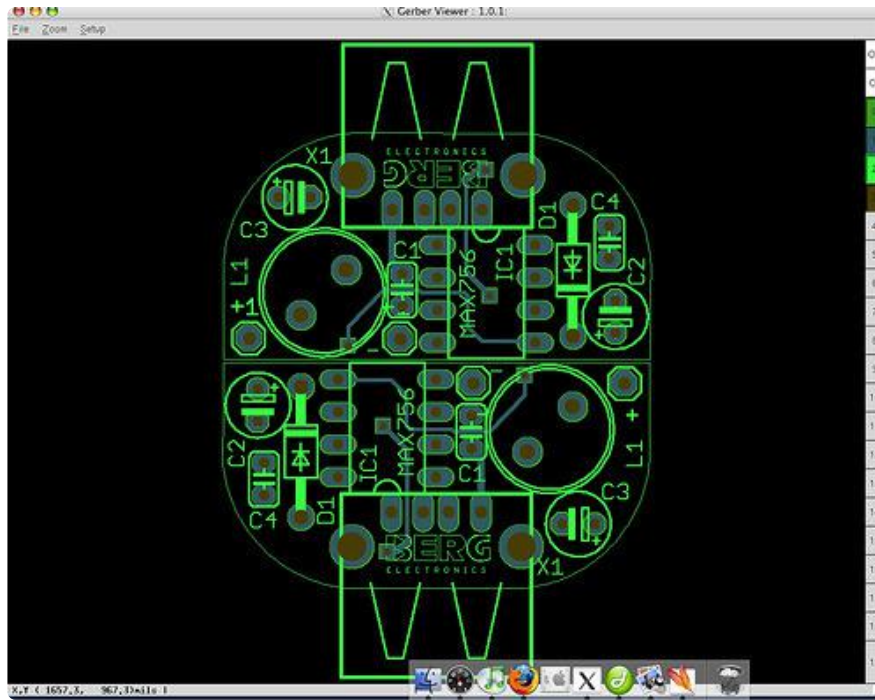

I always check the boards with www.freedfm.com () before I ship them off to be made. I used 4pcb.com so it's the same company but even if you don't go with 4pcb.com as your PCB manufacturer, it's a neat service.

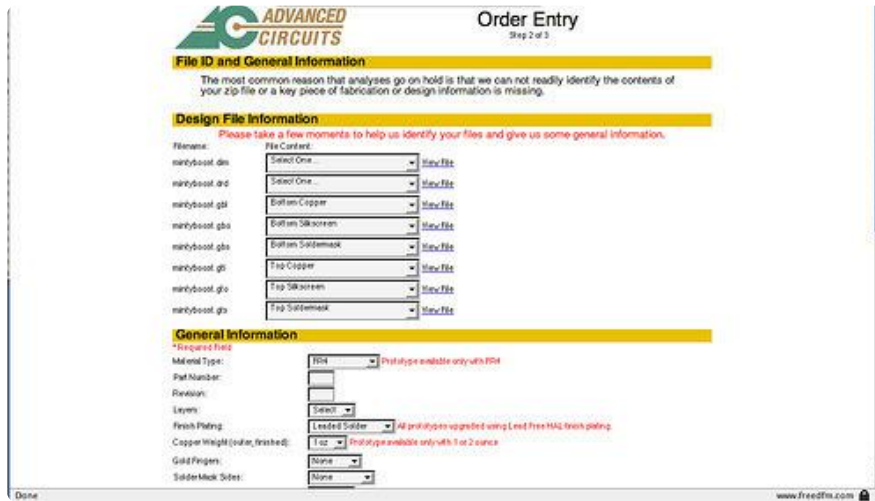

A week later (depending on your turn time) A box shows up with the circuit boards!



Then I sit in front of a computer and do a lot of website stuff. I also take a lot of photos. A good photo setup will make documentation easy. I have a simple 150W ECT bulb + diffuser setup at EYEBEAM. A tripod is key!



Mintyboost® is a registered trademark of Adafruit Industries

iCharging

The mysteries of Apple device charging

The Video

TL;DR? Watch this video which not only talks about iPhones and charging but also hot air rework.

Want more details? Read below!

Quick introduction to USB



Every computer has a USB connector on it, and all the connectors are the same, with 4 pins. One pin is Ground, two pins are Data (D+ and D-) and the last pin is 5V power. The Ground and 5V pins are used to provide power to whatever is plugged in - keyboard, mouse, USB key, etc. The two data lines are used to transfer information back and forth - what keys are pressed, saving files to the USB drive, etc.

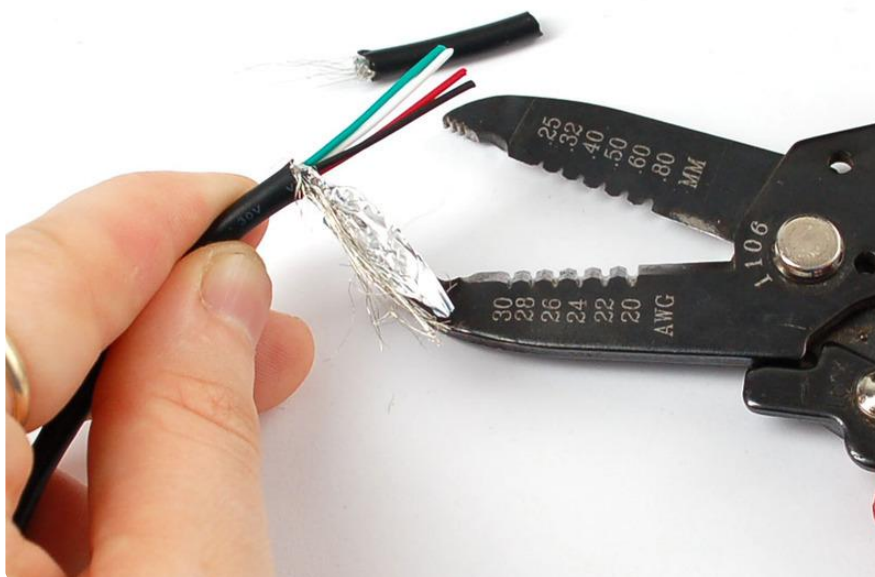

Shown above, the 4 wires. Red is power, black is ground, and the white and green wires are the data lines.

Using USB as a power supply

Some inexpensive USB toys (say a USB fan or [mini soda cooler](#) ()) don't have any data transfer, they just suck the power from the USB port to run. In this case, they do not use or connect to the Data pins (they are left to 'float').

Now technically USB ports can provide up to 500mA of current output, and technically every device is supposed to perform a basic data transfer to the computer (called enumeration) where it says "hey, I'm about to drag 500mA out of the computer, just so you know" and the computer can say "go ahead" or "no can do" (this is called the power negotiation).

However, we've found that every device that does not require to do any data transfer (say, USB fans or USB battery chargers) don't bother to warn the computer and just go ahead and grab up to (or even more!) than 500mA from the USB port. As long as they aren't going thru an unpowered hub, this seems to be just fine. All computers have a resettable fuse on the USB port so that if more than 1000mA is drawn, the power will be disconnected. This protects against short circuits in your \$5 USB fan that would take down the entire computer!

iCharge!

Knowing the above, we designed the first Mintyboost to not have anything on the data lines - we assumed that nearly every charger and device would just ignore those pins as they tend not to be used

For example, in the CAD file of the first Mintyboost, the USB connector is the top square. The four ovalish pins in row as the USB wires. Pin #1 and #4 are used for power (blue lines are connected) but there are no traces on the middle two data pins - they are floating.

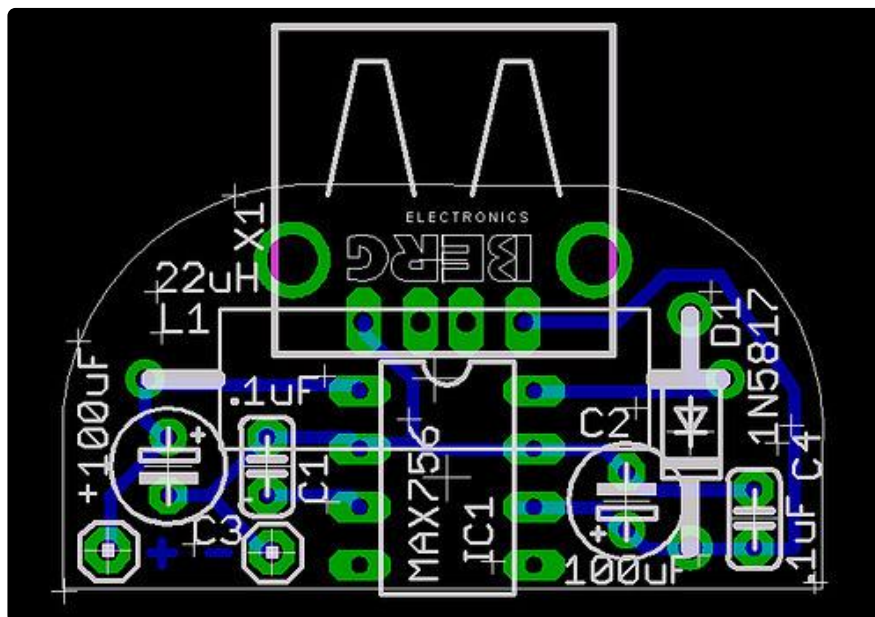

When we [first released the v1.0 of the MintyBoost oh so long ago](#) (), we quickly got feedback from people who owned all sorts of Apple brand gadgets. It turned out that older devices worked fine but some of the newer ones, such as the iPod Mini, were

not charging. Hmm! Time to experiment!

First attempt

We figured there was something simple that would make the Apple device charge, and it definitely had to do with the data lines (the power lines are fixed at ground and 5V). We thought "is there an enumeration chip inside every charger?" but since that's expensive and kind of overkill we decided instead to read up on the [USB protocol \(go Jan!\) \(\)](#). In particular, in her fantastic book there's a part about the low level signaling states. Since you want to get the iPod charging, but NOT make it try to enumerate, we figured that we should see if there was some sort of special state you could put the data lines into that would say "no computer is attached but there is power". Turns out there is! It's called the SE1 and occurs when BOTH data lines are at 3V.

Now to test. We stole an iPod from a friend and cut open a cable so we could mess with the data lines. We tried 3 options each - connected to ground, connected to 3V and not connected (float). At the same time we measured the current draw going through the power line. We found the following:

iPod Mini	D- pin / R4			
	x	0V	float	>3V
D+ pin	0V	x	x	100mA
R5	float	x	x	250mA
	>3V	x	250mA	250mA

OK, so yes when the pins are floating no charging occurs. The next thing to note is that whether the pins are pulled up or down affects the current draw. Since this was the first Mintyboost, using the MAX756, we wanted to use the lower 100mA rate so one pin pulled down and another pulled up. This would be more efficient for the battery use and keep the chip from getting hot (it could provide 250mA but didn't like it much).

Thus was born Mintyboost v1.1!

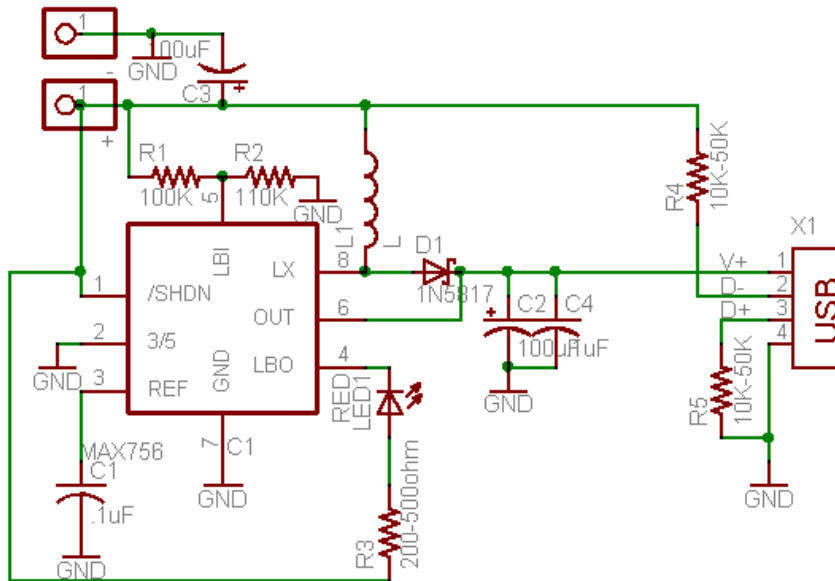

Note that because the mintyboost runs from 2 AA batteries, we can get 3V directly from the batteries so we connected the pullup right to the battery input.

The iPhone and larger iPods

This worked ok for about a year, then people starting getting the newer iPods and noticed that the Mintyboost didn't work anymore.

More testing!

iPod Nano 2G	D- pin / R4			
D+ pin R5	x	0V	float	>3V
	0V	x	x	x
	float	x	x	250mA
	>3V	x	100mA	250mA
iPod Shuffle 2G (clip-on)	D- pin / R4			
D+ pin R5	x	0V	float	>3V
	0V	x	x	x
	float	x	x	x
	>3V	x	x	100mA (max)

Hmm, looks like we need to have two pull ups after all. We made a new version that now had either a pulldown or pullup on the D+ line.

iPhones

This worked for a bit until the iPhones came out. With enormous batteries, the iPhone was not happy charging at 250mA - it wanted 500mA or even 1000mA to charge! We sought out an upgrade to the MAX756 and found the LT1302 which could provide 500mA no problem.



Using 100K pullups on the data lines worked pretty good and all was happy! Then the iPhone 3Gs came out and...



Apple stopped being as 'lax' with the charging interface and started being very picky about having the official chargers. We still doubted that there was an enumeration chip inside each charger - too expensive and complex. So there must be something else going on in those data lines.

Time to sacrifice an official Apple iPhone 3Gs charger!



Taking it apart, desoldering the 4 data line resistors and measuring them on our multimeter, we found the following as shown in the schematic:

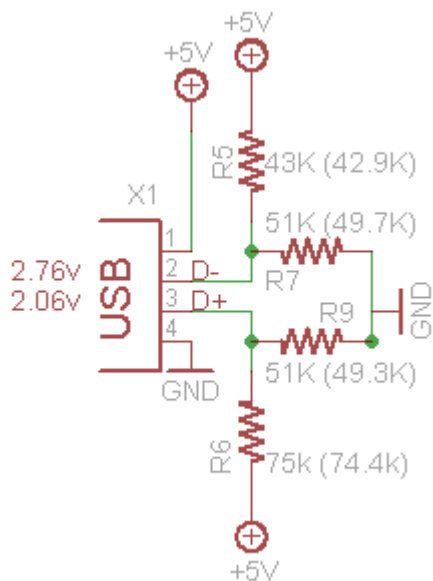

The four resistors create a voltage at each of the data lines that's not 3.3V but rather 2.8 and 2.0 (or so) volts. The problem is that when you do this, the iPhone starts to draw as much as 1Amp! Way more than the LT1302 and a couple AA's can provide. We were a bit sad and thought that there was no way to get the Mintyboost working with an iPhone when we took a trip to J&R and found an item called the TuneJuice. The TuneJuice is an iPhone charger that uses 4 AAA batteries. This is very interesting because there is no way to get an Amp out of AAA's - they are just way too small. That means there must be something ELSE going on in that TuneJuice charger to keep the iPhone from gobbling up the batteries. So we took apart the charger!

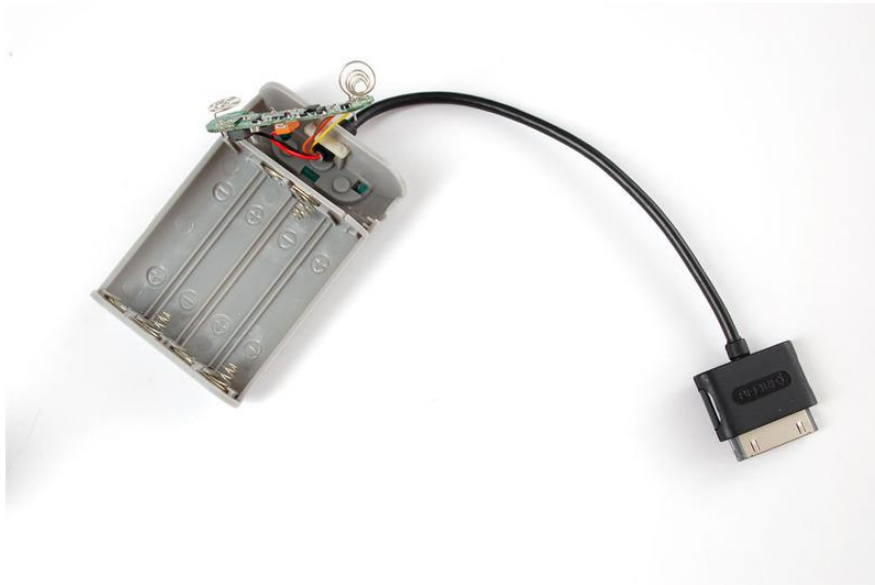

And found the following! (We substituted the closest 1% resistor values)

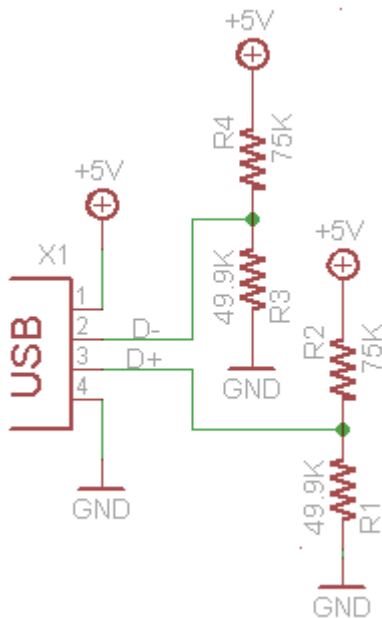

This time both voltages on the data lines are = $49.9K / (49.9K + 75K) * 5.0V = 2.0V$

We did some experimenting (see the video up top) and determined that in fact the different voltages/resistances did effect the charging rates! Using the 2.8V&2.0V setup resulted in a 1 Amp charge rate and the 2.0V&2.0V setup resulted in a 500mA charge rate.

This made us very happy, because 500mA is within the capability of the MintyBoost chip. We redesigned the PCB to allow us to have 4 resistors on the datalines and put two 75K and two 49.9K resistors in each kit. So far we have had no problems charging any of the latest Apple devices. Hooray!

Change Log

What's changed?

A long history of boosting

The mintyboost is one of our oldest projects, and has evolved to work with more and more products. Here are the differences between the many versions!

V1.0 - June 2006 (first release)

(Schematic is essentially the same as the v1.1 but without R4 and R5)

Documented in the process page, this kit used the [MAX756 boost chip from Maxim \(\)](#), and could provide about 100-150mA output at 5V. There were no data line resistors for pulling up or down but it worked with most things.

v1.1 - July 2006

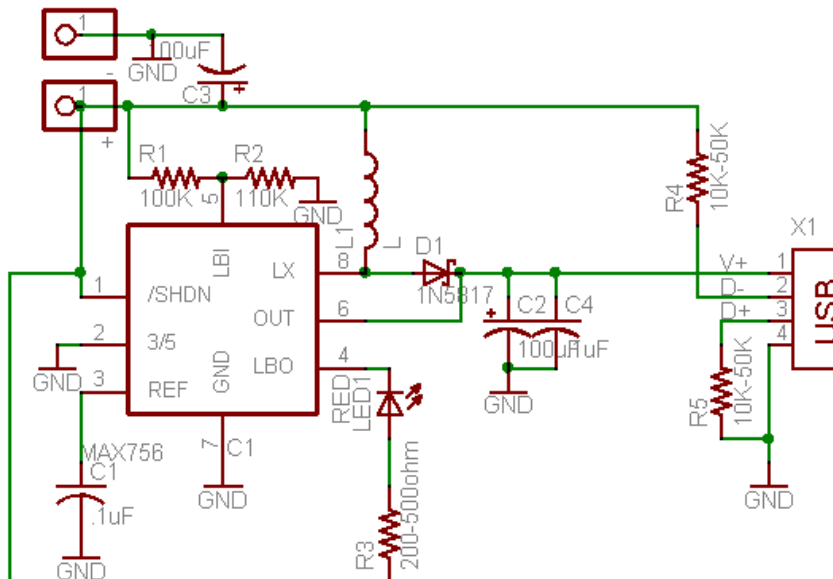

After a few months it became clear that some devices especially Apple music players, needed pullup/down resistors, so a new version that could fit 1 pullup and 1 pulldown was designed. This version still used the [MAX756 \(\)](#).

v1.2 - April 2007

(Schematic is essentially the same as the v1.1 but with an additional resistor slot from D- to ground)

Turns out that some devices wanted two pullups on either data pin, so version 1.2 had an option to use D+'s R5 resistor as either a pulldown or pullup. This version still used the [MAX756](#) ().

v2.0 - August 2008

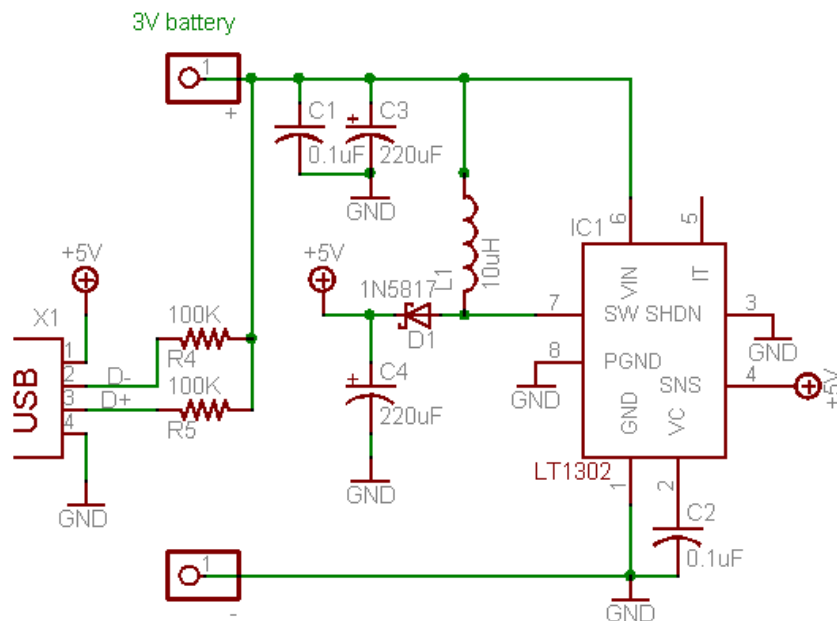

Smartphones started coming out and becoming popular, and devices with massive batteries, which meant that charging at 100mA was a no go. The mintyboost was then upgraded to the [LT1302](#) (), a more expensive chip but one with a nice 500mA output ability!

This version worked pretty well for a very long time until about the iPhone 3Gs came out at which point [Apple became a lot pickier about 'authorized' chargers](#) ().

v3.0 - August 2010

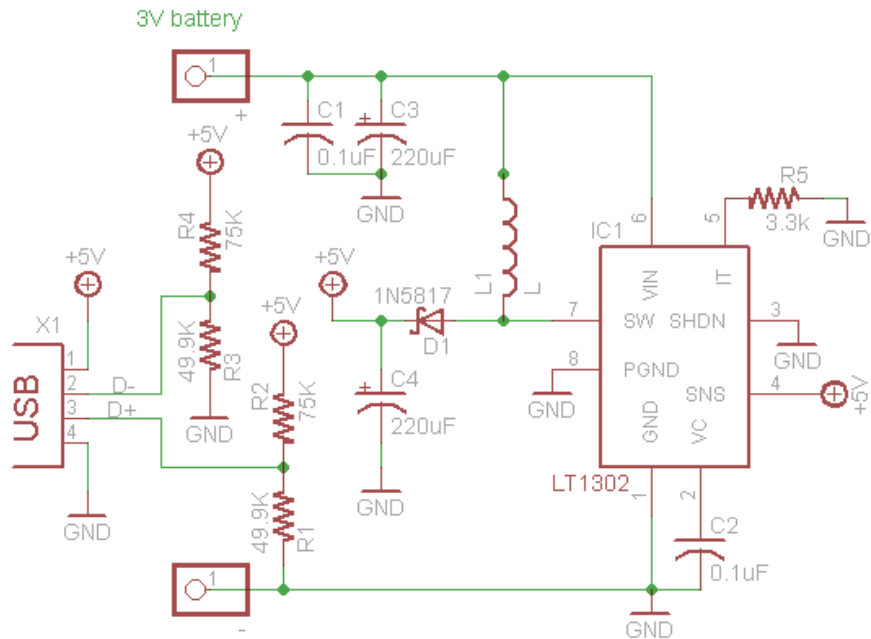

[To improve compatibility with the latest smartphones and Apple devices, the charging protocol was reverse engineered so that the Mintyboost would be more universal. The pullup/down pins were also changed a full resistive divider which made it work with LiPoly batteries and Apple devices \(\)](#). Still uses a LT1302 chip.

A 3.3K pulldown R5 was also added to turn off low-power 'boost mode' in the LT1302 chip, this improved high-drain handling at the risk of lower efficiency at low current draw. However, at this point, almost all devices have large batteries (> 500mAh) and require high charge rates.

Download

Datasheets

- [LT1302 \(\)](#) page
- [MAX756 \(\)](#) datasheet
- [AA NiMH \(\)](#) datasheet

CAD Files

v2.0 files

- [v2.0 Schematic in PNG \(\)](#)

- [v2.0 Schematic \(\)](#) and [Board layout \(\)](#) files in EagleCAD format

All of these files are available under the [Creative Commons \(\)](#) 2.5 attribution license.

v1.0, v1.1 and v1.2 files

You can use these files with the DN2474 inductor, it's single-sided so it's easy to etch at home. You can generate Gerbers or extract a postscript image (for toner transfer) easily, using [EagleCAD \(\)](#), freely available for Mac/Win/Linux.

- Prototype [schematic \(\)](#) and [board \(\)](#) files

Here are the final files, for the kit. They use a radial inductor and have pads for a low battery indicator SMT LED. It's doublesided but there's only one trace to jumper if you're not using the low battery indicator.

- V1.0 [schematic \(\)](#) and [board \(\)](#) files

I then did a minor upgrade to add a pullup and pulldown for better performance:

- V1.1 [schematic \(\)](#) and [board \(\)](#) files

All of these files are available under the [Creative Commons \(\)](#) 2.5 attribution license.