

# RI360P1-QR14-ELIU5X2-0.3-RS5

## Inductive Angle Sensor – With Analog Output

### Premium Line

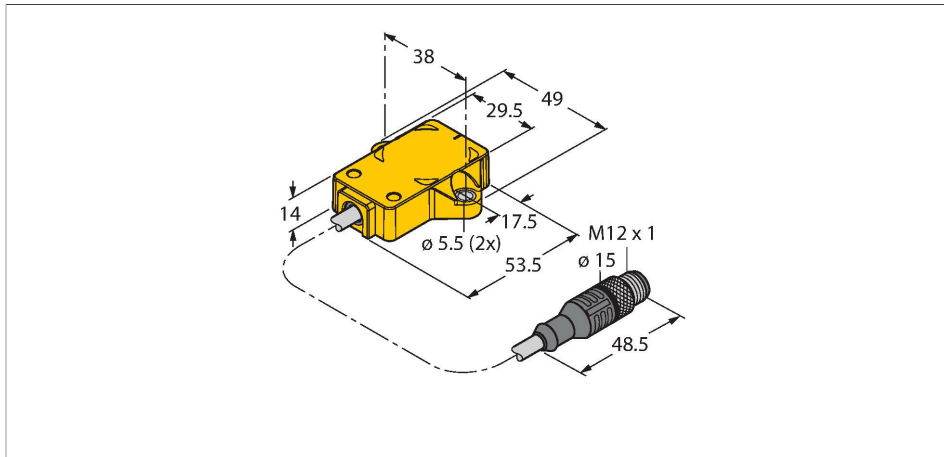

### Features

- Rectangular, plastic
- Many mounting possibilities
- P1-Ri-QR14 included in delivery
- Measuring range displayed via LED
- Immune to electromagnetic interference
- Resolution, 12-bit
- 15...30 VDC
- Analog output
- Programmable measuring range
- 0...10 V and 4...20 mA
- Cable with male connector, M12 × 1

### Technical data

Type	RI360P1-QR14-ELIU5X2-0.3-RS5
ID	1590854
Measuring principle	Inductive
<b>General data</b>	
Starting torque shaft load (radial / axial)	Not applicable because of contactless measuring principle
Resolution	0.09°
Measuring range	0...360 °
Nominal distance	1.5 mm
Repeat accuracy	≤ 0.025 % of full scale
Linearity deviation	≤ 0.3 % f.s.
Temperature drift	≤ ± 0.01 % / K
Output type	Absolute singleturn
<b>Electrical data</b>	
Operating voltage	15...30 VDC
Residual ripple	≤ 10 % U <sub>ss</sub>
Isolation test voltage	≤ 0.5 kV
Short-circuit protection	yes
Wire breakage/Reverse polarity protection	yes / yes (voltage supply)
Output function	5-pin, Analog output
Voltage output	0...10 V
Current output	4...20 mA
Load resistance voltage output	≥ 4.7 kΩ

### Wiring diagram

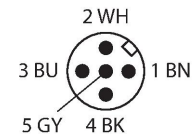
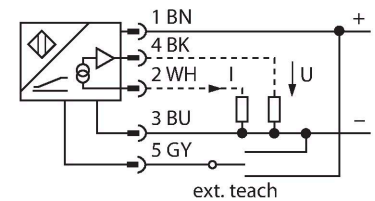

### Functional principle

The measuring principle of inductive angle sensors is based on oscillation circuit coupling between the positioning element and the sensor, whereby an output signal is provided proportional to the angle of the positioning element. The rugged sensors are wear and maintenance-free, thanks to the contactless operating principle. They convince through their excellent repeatability, resolution and linearity within a broad temperature range. The innovative technology ensures a high immunity to electromagnetic DC and AC fields.

## Technical data

Load resistance current output	$\leq 0.4 \text{ k}\Omega$
Sample rate	800 Hz
Current consumption	$< 50 \text{ mA}$
<b>Mechanical data</b>	
Design	Rectangular, QR14
Dimensions	53.5 x 49 x 14 mm
Flange type	Flange without mounting element
Shaft Type	Blind hole shaft
Shaft diameter D [mm]	6 6.35
Housing material	Plastic, PBT-GF30-V0
Electrical connection	Cable with connector, M12 x 1
Cable quality	$\varnothing 5.2 \text{ mm}$ , Black, LifYY, PVC, 0.3 m
Core cross-section	$5 \times 0.25 \text{ mm}^2$
<b>Environmental conditions</b>	
Ambient temperature	$-25 \dots +70 \text{ }^\circ\text{C}$
Vibration resistance	55 Hz (1 mm)
Vibration resistance (EN 60068-2-6)	20 g; 10...3000 Hz; 50 cycles; 3 axes
Shock resistance (EN 60068-2-27)	100 g; 11 ms $\frac{1}{2}$ sine; 3 x each; 3 axes
Continuous shock resistance (EN 60068-2-29)	40 g; 6 ms $\frac{1}{2}$ sine; 4000 x each; 3 axes
Salt spray test (EN 60068-2-52)	Severity degree 5 (4 test cycles)
Protection class	IP68 IP69K
MTTF	138 years acc. to SN 29500 (Ed. 99) 40 $^\circ\text{C}$
Power-on indication	LED, Green
Measuring range display	multifunction LED, green green flashing
Included in delivery	positioning element P1-Ri-QR14; for technical details see data sheet

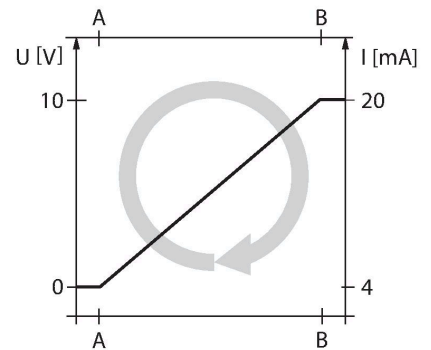

## Mounting instructions

### Mounting instructions/Description

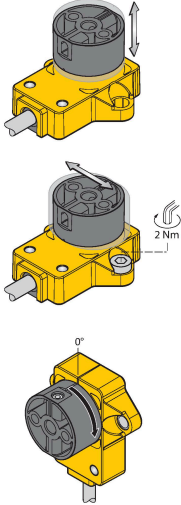

Adapter pins provide more flexibility  
 Extensive range of mounting accessories  
 for easy adaptation  
 to many different shaft diameters.  
 LED function  
 Operating voltage  
 Green: Voltage is present  
 Displayed measuring range  
 Green: Positioning element is within the  
 detection range  
 Flashing green: Positioning element is within  
 the  
 measuring range with reduced signal quality  
 (e.g.  
 the distance is too great)  
 Off: Positioning element is outside the  
 sensing range  
 Functional safety thanks to the inductive  
 measuring principle  
 The measuring principle of RLC coupling  
 makes the sensor  
 absolutely wear-free and  
 immune to magnetized ferrous chips  
 and other interference fields.  
 Owing to the differential analysis,  
 the output signal remains almost unchanged,  
 even if the position of the positioning element  
 deviates from the ideal axis of rotation. The  
 distance  
 between the sensor and the positioning element

Variably adjustable (teaching with position sensor)

Bridge between teach input pin 5 (GY)	Gnd Pin 3 (BU)	Ub Pin 1 (BN)	LED
2 seconds	Initial value	End value	Power LED flashes then lights steadily after 2 s
10 seconds	CCW rotation, then return to last preset value	CW rotation, then return to last preset value	After 10 s power LED flashes quickly for 2 s
15 seconds	-	Factory setting (360°, CW)	Power and status LED alternate after 15 seconds

Preset – Mode (teach without position sensor)

Bridge between teach input pin 5 (GY)	Gnd Pin 3 (BU)	Ub Pin 1 (BN)	LED
2 seconds	Activate preset mode	Activate preset mode	Power LED steady, flashes after 2 s
10 seconds	CCW rotation, then return to last preset value	CW rotation, then return to last preset value	After 10 s power LED flashes quickly for 2 s
15 seconds	-	Factory settings (360°, CW)	Power and status LED alternate after 15 seconds
Angular range	Gnd Pin 3 (BU)	Ub Pin 1 (BN)	Power LED
30°	Press x 1	-	Blinking x 1
45°	Press x 2	-	Blinking x 2
60°	Press x 3	-	Blinking x 3
90°	-	Press x 1	Blinking x 1
180°	-	Press x 2	Blinking x 2
270°	-	Press x 3	Blinking x 3
360°	-	Press x 4	Blinking x 4

## Accessories

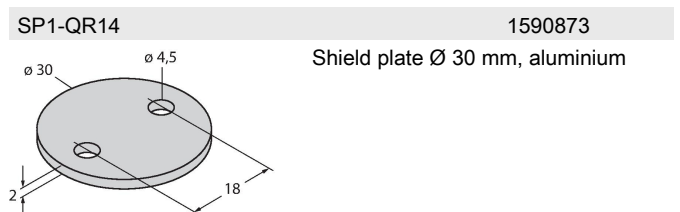
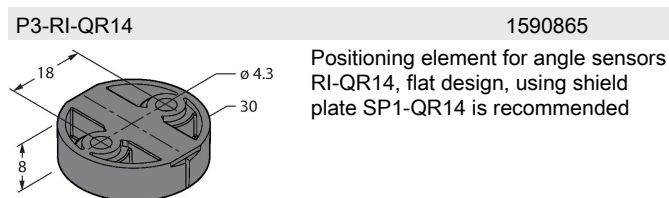
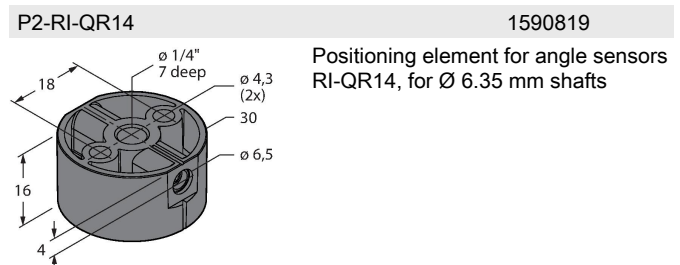
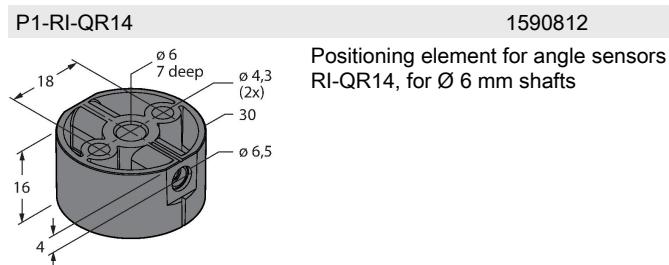

HSA-M6-QR14

6901051

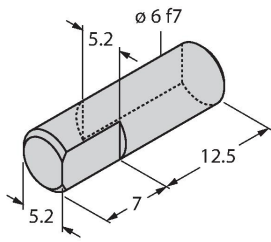

Adapter for RI-QR14 specific positioning elements, hollow on solid shaft, Ø 6 mm

HSA-M8-QR14

6901052

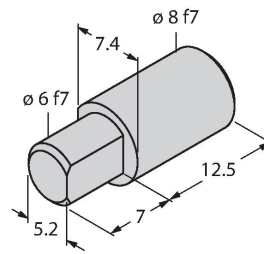

Adapter for RI-QR14 specific positioning elements, hollow on solid shaft, Ø 8 mm

DS-RI-QR14

1590814

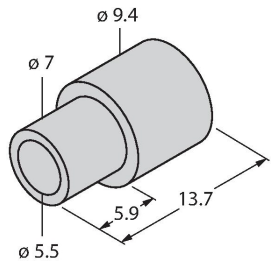

Spacer sleeves for rear mounting of RI-QR14, 2 pcs. per bag