

RI360P2-QR14-ELIU5X2

Inductive Angle Sensor – With Analog Output

Premium Line

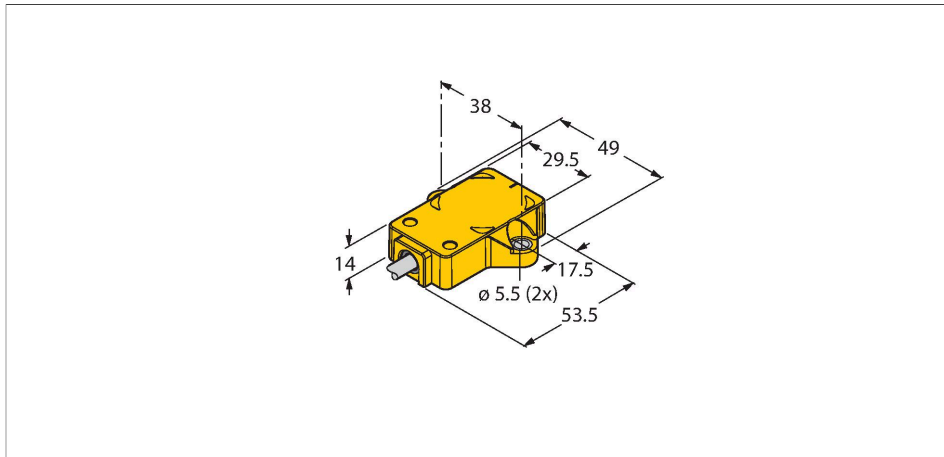

Features

- Rectangular, plastic
- Many mounting possibilities
- P2-Ri-QR14 included in delivery
- Measuring range displayed via LED
- Immune to electromagnetic interference
- Resolution, 12-bit
- 4-wire, 15...30 VDC
- Analog output
- Programmable measuring range
- 0...10 V and 4...20 mA
- Cable connection

Technical data

Type	RI360P2-QR14-ELIU5X2
ID	1590857
Measuring principle	Inductive
General data	
Starting torque shaft load (radial / axial)	Not applicable because of contactless measuring principle
Resolution	0.09°
Measuring range	0...360 °
Nominal distance	1.5 mm
Repeat accuracy	≤ 0.025 % of full scale
Linearity deviation	≤ 0.3 % f.s.
Temperature drift	≤ ± 0.01 % / K
Output type	Absolute singleturn
Electrical data	
Operating voltage	15...30 VDC
Residual ripple	≤ 10 % U _{ss}
Isolation test voltage	≤ 0.5 kV
Short-circuit protection	yes
Wire breakage/Reverse polarity protection	yes / yes (voltage supply)
Output function	4-wire, Analog output
Voltage output	0...10 V
Current output	4...20 mA
Load resistance voltage output	≥ 4.7 kΩ

Wiring diagram

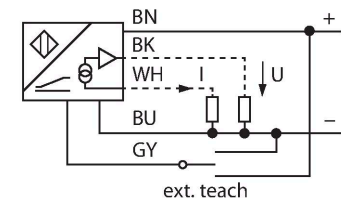

Functional principle

The measuring principle of inductive angle sensors is based on oscillation circuit coupling between the positioning element and the sensor, whereby an output signal is provided proportional to the angle of the positioning element. The rugged sensors are wear and maintenance-free, thanks to the contactless operating principle. They convince through their excellent repeatability, resolution and linearity within a broad temperature range. The innovative technology ensures a high immunity to electromagnetic DC and AC fields.

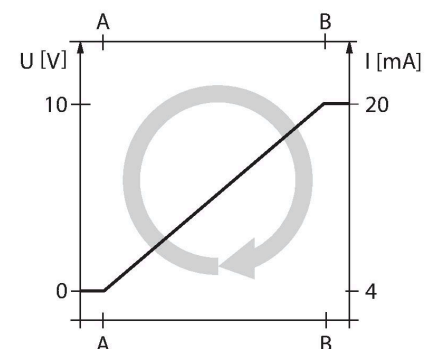

Technical data

Load resistance current output	≤ 0.4 kΩ
Sample rate	800 Hz
Current consumption	< 50 mA
Mechanical data	
Design	Rectangular, QR14
Dimensions	53.5 x 49 x 14 mm
Flange type	Flange without mounting element
Shaft Type	Blind hole shaft
Shaft diameter D [mm]	6 6.35
Housing material	Plastic, PBT-GF30-V0
Electrical connection	Cable
Cable quality	Ø 5.2 mm, Black, LifYY, PVC, 2 m
Core cross-section	5 x 0.25 mm ²
Environmental conditions	
Ambient temperature	-25...+70 °C
Vibration resistance	55 Hz (1 mm)
Vibration resistance (EN 60068-2-6)	20 g; 10...3000 Hz; 50 cycles; 3 axes
Shock resistance (EN 60068-2-27)	100 g; 11 ms ½ sine; 3 × each; 3 axes
Continuous shock resistance (EN 60068-2-29)	40 g; 6 ms ½ sine; 4000 × each; 3 axes
Salt spray test (EN 60068-2-52)	Severity degree 5 (4 test cycles)
Protection class	IP68 IP69K
MTTF	138 years acc. to SN 29500 (Ed. 99) 40 °C
Power-on indication	LED, Green
Measuring range display	multifunction LED, green green flashing
Included in delivery	positioning element P2-Ri-QR14; for technical details see data sheet

Mounting instructions

Mounting instructions/Description

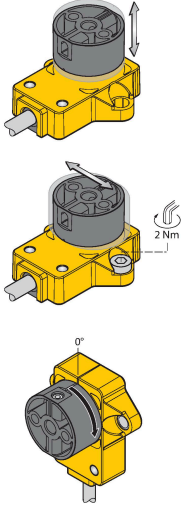

Adapter pins provide more flexibility
 Extensive range of mounting accessories
 for easy adaptation
 to many different shaft diameters.
 LED function
 Operating voltage
 Green: Voltage is present
 Displayed measuring range
 Green: Positioning element is within the
 detection range
 Flashing green: Positioning element is within
 the
 measuring range with reduced signal quality
 (e.g.
 the distance is too great)
 Off: Positioning element is outside the
 sensing range
 Functional safety thanks to the inductive
 measuring principle
 The measuring principle of RLC coupling
 makes the sensor
 absolutely wear-free and
 immune to magnetized ferrous chips
 and other interference fields.
 Owing to the differential analysis,
 the output signal remains almost unchanged,
 even if the position of the positioning element
 deviates from the ideal axis of rotation. The
 distance
 between the sensor and the positioning element

Individual (teaching with positioning element)

Jumper between teach input Pin 5 (GY)	Gnd Pin 3 (BU)	Ub Pin 1 (BN)	LED
2 seconds	start value	end value	status LED flashes, after 2 s steady
10 seconds	CCW rotation, then return to last preset value	CW rotation, then return to last preset value	after 10 s status LED flashes fast for 2 s
15 seconds	-	default setting (360°, CW)	after 15 s power and status LED alternate

Preset – Mode (teaching without positioning element)

Jumper between teach input Pin 5 (GY)	Gnd Pin 3 (BU)	Ub Pin 1 (BN)	LED
2 seconds	activate preset mode	activate preset mode	status LED steady, flashes after 2 s
10 seconds	CCW rotation, then return to last preset value	CW rotation, then return to last preset value	after 10 s status LED flashes fast for 2 s
15 seconds	-	default setting (360°, CW)	after 15 s power and status LED alternate
Angular range	Gnd Pin 3 (BU)	Ub Pin 1 (BN)	status LED
30°	press once	-	1 x flashing
45°	press twice	-	2 x flashing
60°	press three times	-	3 x flashing
90°	-	press once	1 x flashing
180°	-	press twice	2 x flashing
270°	-	press three times	3 x flashing
360°	-	press four times	4 x flashing

Accessories

P1-RI-QR14 1590812

Positioning element for angle sensors RI-QR14, for Ø 6 mm shafts

P2-RI-QR14 1590819

Positioning element for angle sensors RI-QR14, for Ø 6.35 mm shafts

P3-RI-QR14 1590865

Positioning element for angle sensors RI-QR14, flat design, using shield plate SP1-QR14 is recommended

SP1-QR14 1590873

Shield plate Ø 30 mm, aluminium

HSA-M6-QR14 6901051

Adapter for RI-QR14 specific positioning elements, hollow on solid shaft, Ø 6 mm

HSA-M8-QR14 6901052

Adapter for RI-QR14 specific positioning elements, hollow on solid shaft, Ø 8 mm

DS-RI-QR14

1590814

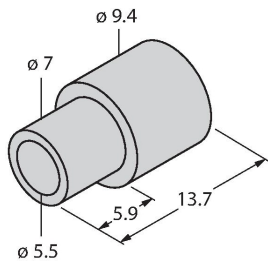

Spacer sleeves for rear mounting of
RI-QR14, 2 pcs. per bag