

# Leadership in fusible circuit protection



*Powering Business Worldwide*



We make what matters work.\*



At Eaton, we believe that power is a fundamental part of just about everything people do. That's why we're dedicated to helping our customers find new ways to manage electrical, hydraulic and mechanical power more efficiently, safely and sustainably. To improve people's lives, the communities where we live and work, and the planet our future generations depend upon. Because this is what really matters. And we're here to make sure it works.

To learn more go to: [Eaton.com/whatmatters](https://www.eaton.com/whatmatters)

**EATON**

*Powering Business Worldwide*

**We make what matters work.**

**Eaton is the leading source of fusible circuit protection solutions in the global marketplace. Eaton's Bussmann series products are approved for use around the world and meet agency requirements and international standards: IEC, VDE, DIN,UL, CSA, BS and others.**

The headquarters for Eaton's Bussmann series product line is located in Burton-on-the-Wolds, Leicestershire (UK) and is part of Eaton's Industrial Control and Protection EMEA division.

Eaton manufactures over 50,000 Bussmann series part numbers, covering extensive fusible circuit protection solutions for a wide range of applications: residential, industrial, motor protection, power conversion and distribution.

Eaton has been a leading exponent in the design, development and manufacture of fuse links and their associated accessories for more than 100 years and has supplied fuse links to more than 90 countries worldwide.

Eaton's team of specialist Engineers and Field Applications Engineers plays a leading role in international standardisation of fuse links offering comprehensive advice on selection and applications.

With a continual commitment to meet our customers' needs with innovative high quality ~products with ISO 9001 'approval systems', Eaton is the supplier of choice for circuit protection solutions.

# Table of contents

<b>North American fuse links</b>				<b>6</b>
	130 V a.c. / V d.c.	1000 A to 4000 A	FWA	6
	150 V a.c. / V d.c.	70 A to 1000 A	FWA	9
	250 V a.c. / V d.c.	35 A to 2500 A	FWX	13
	500 V a.c. / V d.c. (UL)	50 A to 400 A	CHSF	16
	500 V a.c. / V d.c.	35 A to 1600 A	FWH	20
	600 V a.c.	1 A to 1000 A	KAC	23
	600 V a.c.	35 A to 800 A	KBC	24
	700 V a.c. / V d.c.	5 A to 1200 A	FWP	25
	1000 V a.c. / 800 V d.c.	35 A to 2000 A	FWJ	31
	1000 V d.c.	70 A to 600 A	FWE	34
<b>British Standard BS88 fuse links</b>				<b>40</b>
	240-250-280 V a.c. / 150 V d.c.	6 A to 180 A	LCT, LET	40
	240-250 V a.c. / 150 V d.c.	160 to 900 A	LMT, LMMT	44
	690-700 V a.c. / 500 V d.c.	6 A to 200 A	CT, ET, FE, EET and FEE	47
	690-700 V a.c. / 350-450-500 V d.c.	160 A to 710 A	FM, FMM, MT and MMT	52
<b>Ferrule fuse links</b>				<b>58</b>
	150 V a.c. / V d.c.	5 A to 60 A	FWA	58
	250 V a.c. / V d.c.	1 to 50 A	FWX	61
	500 V a.c.	0.25 to 30 A	FWH-A6F	64
	500 V a.c. / V d.c.	1 to 30 A	FWH-14F	66
	600-700 V a.c. / 700 V d.c.	1 to 32 A	FWC	68
	690 V a.c.	4 to 32 A	FWP-G10F	70
	690 V a.c.	4 to 50 A	FWP-G14F	73
	690 V a.c.	20 to 100 A	FWP-G22F	76
	690-700 V a.c. / 600-700 V d.c.	1 to 50 A	FWP-A14F	79
	700 V a.c. / V d.c.	20 to 100 A	FWP-A22F	82
	750 V d.c.	5 to 60 A	FWK-A20F and FWK-A25F	84
	1000 V a.c. / 800 V d.c.	20 to 30 A	FWJ	86
	1200 V a.c. / 1000 V d.c.	20 to 30 A	FWL	88
	1400-2000 V a.c. / 1000 V d.c.	2 to 15 A	FWS	90
<b>Square body fuse links</b>				<b>92</b>
<b>DIN 43653</b>	690-700 V a.c. / V d.c.	10 to 400 A	170M - size 000 and 00	92
	690-700 V a.c.	40 to 2000 A	170M - size 1* to 3	98
	1000 V a.c.	20 to 315 A	170M - size 00	108
	1000 V a.c.	50 to 1400 A	170M - size 1* to 3	111
	1250-1300 V a.c.	50 to 1400 A	170M - size 1* to 3	121
<b>DIN 43620</b>	690 V a.c.	10 to 800 A	170M - size 00 to 3	131
	690-700 V a.c.	10 to 1600 A	170M - dual indicator	141
	1000 V a.c.	20 to 225A	170M - size 00	151
<b>French style</b>	690-700 V a.c.	40 to 1600 A	170M - size 1* to 3	154
<b>US style</b>	690-700 V a.c.	40 to 2000 A	170M - size 1* to 3	164
	1000 V a.c.	50 to 1400 A	170M - size 1* to 3	174
	1250-1300 V a.c.	50 to 1400 A	170M - size 1* to 3	184
<b>Flush end contact</b>	690 V a.c.	25 to 400 A	170M - size 00	194
	690-700 V a.c.	40 to 2000 A	170M - size 1* to 3	197
	1000 V a.c.	50 to 1400 A	170M - size 1* to 3	207
	1250-1300 V a.c.	50 to 1400 A	170M - size 1* to 3	217
	690-700 V a.c.	1000 to 4000 A	170M - size 4	227
	1000 V a.c.	1000 to 3000 A	170M - size 4	230
	1250 V a.c.	800 to 2500 A	170M - size 4	236
	660 V a.c.	1000 to 4000 A	170M - size 23	242
	1250 V a.c.	630 to 2800 A	170M - size 23	246
	690 V a.c.	2000 to 6500 A	170M - size 24	249
	1000 V a.c.	2000 to 5000 A	170M - size 24	252
	1100-2000 V a.c.	1800 to 5500 A	170M - size 5	255
<b>Drive fuse links</b>	600 V a.c. / 450 V d.c.	1 to 600 A	DFJ	256
<b>IGBT fuse links</b>	750-800 V d.c.	25 to 630 A	170M - size 000 and 230	259
	1000 V d.c.	25 to 500 A	170M - size 000 and 230	265

<b>Traction fuse links</b>				<b>271</b>
<b>Square body</b>	750 V d.c.	50 to 1600 A	170M - size 1*, 3 and 23	271
	750 V d.c.	63 to 500 A	170E - size 1*, 1, 2 and 3	275
	850 V d.c. / 1250 V a.c.	1400 A	170M7217 - size 4	285
	1200 V d.c.	20 to 215 A	170M - size 1*	288
	1200 V d.c.	160 to 420 A	170F - size 2	290
	2000 V d.c.	10 to 80 A	170E - size 1*	292
	2000 V d.c.	10 to 125 A	170E - size 1*	295
	2000 V d.c.	20 to 600 A	170M	300
	2400 V d.c.	100 to 400 A	170M - size 3	304
	4000 V d.c.	20 to 125 A	170E - size 1*	306
	4000 V d.c.	20 to 450 A	170E - size 1*, 2 and 2//2	309
	<b>Ferrule</b>	750 V d.c.	5 to 60 A	FWK
750 V d.c.		30 to 50 A	LRC750	316
1000 V d.c. / 1200-1400-2000 V a.c.		2 to 30 A	FWS and FWL	317
<b>Round body</b>	750 V d.c.	5 to 60 A	KC36	318
	750 V d.c.	200 to 400 A	RC	319
	1500 V d.c.	25 to 200 A	NBC	320
<b>Photovoltaic fuse links, fuse bases and holders</b>				<b>321</b>
	600 V d.c.	4 to 30 A	PVM 10 x 38 mm fuse links	321
	1000 V d.c.	1 to 20 A	PV-A10F 10 x 38 mm fuse links	323
		CHPV	10 x 38 mm Modular fuse holder	326
	1500 V d.c.	2.25 A to 30 A	PV-A10F85L 10 x 85 mm fuse links	327
		CHPV15H85	10 x 85 mm fuse holder	329
	1000-1100 V d.c.	15 to 32 A	PV-14F 14 x 51 mm PV fuse links	330
		CHPV14	14 x 51 mm Modular fuse holder	332
	1300-1500 V d.c.	15 to 32 A	PV-14L 14 x 65 mm fuse links	333
	800 V a.c.	32 A to 400 A	NH 170M PV fuse links	336
	1000 V d.c.	32 to 400 A	PV-ANH fuse links	343
		SD-D-PV	NH Bases	352
	1000 V d.c.	160 to 400 A	PV-AF Flush end PV fuse links	354
	1000-1500 V d.c.	50 to 600 A	PV XL fuse links	357
		SD-S-PV	XL PV Bases	367
<b>Battery storage fuse links</b>				<b>369</b>
	1000 V d.c.	63 A to 400 A	BSF-NH fuse links	369
	1500 V d.c.	250 A to 500 A	BSF-XL fuse links	374
<b>Accessories</b>				<b>377</b>
<b>Fuse bases</b>		Modular style	C5268, 1BS and BH	377
		Fixed center	170H	378
		Ferrule	BMM and CVRI	381
		Ferrule	JM70100	383
<b>Modular knifeblade fuse blocks</b>			JM60	384
<b>Modular fuse holders</b>		10 x 38 mm	CHM, CHPV, CHCC	387
		14 x 51 mm	CH14	389
		22 x 58 mm	CH22	391
<b>Microswitches</b>		Square body	170H0235 to 170H0237 and 170H0069	393
		BS88-4	EC, MC and TI	395
<b>Mountable fuse clips</b>			FW14-PCB	396
<b>Index</b>				<b>398</b>

# North American fuse links

## FWA - 130 V a.c. / V d.c.(UL), 1000 A to 4000 A

### Specifications

#### Description

North American style flush end high speed fuse links for the protection of DC common bus, DC drives, power converters/rectifiers and reduced rated voltage starters.

#### Technical data

- Rated voltage: 130 V a.c. / V d.c. (UL)
- Rated current: 1000 A to 4000 A
- Breaking capacity:
  - 200 kA RMS Sym at 130 V a.c.
  - 50 kA at 130 V d.c.

#### Standards / Agency information

CE, UL Recognised JFHR2.E91958 on 1000 A to 2000 A fuse links



#### Catalogue numbers

Rated voltage	Rated current (Amps)	I <sup>2</sup> t (A <sup>2</sup> Sec)		Watts loss (W)	Catalogue numbers
		Pre-arcing	Clearing at 130 V a.c.		
130 V a.c. / V d.c. (UL)	1000	170,000	460,000	60	FWA-1000AH
130 V a.c. / V d.c. (UL)	1200	270,000	730,000	70	FWA-1200AH
130 V a.c. / V d.c. (UL)	1500	520,000	1,400,000	78	FWA-1500AH
130 V a.c. / V d.c. (UL)	2000	860,000	2,400,000	108	FWA-2000AH
130 V a.c. / V d.c. (UL)	2500	1,500,000	4,100,000	130	FWA-2500AH
130 V a.c. / V d.c. (UL)	3000	2,100,000	5,700,000	150	FWA-3000AH
130 V a.c. / V d.c. (UL)	4000	3,400,000	9,200,000	257	FWA-4000AH

#### Dimensions (in) - 1000 A to 3000 A

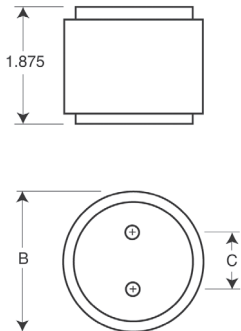

#### Dimensions (in) - 4000 A

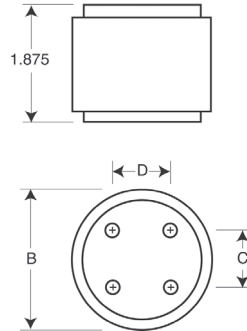

Rated current (Amps)	B	C	D	Thread depth
1000 to 2000	2	1	-	Tapped 3/8"-24 x 1/2" UNF
2500 to 3000	3	1.5	-	Tapped 1/2"-20 x 1/2" UNF
4000	3.5	1.5	1.5	Tapped 1/2"-20 x 1/2" UNF

1" = 25.4mm

**FWA - 130 V a.c. / V d.c.(UL), 1000 A to 4000 A**

Time-current curve - 1000 A to 4000 A

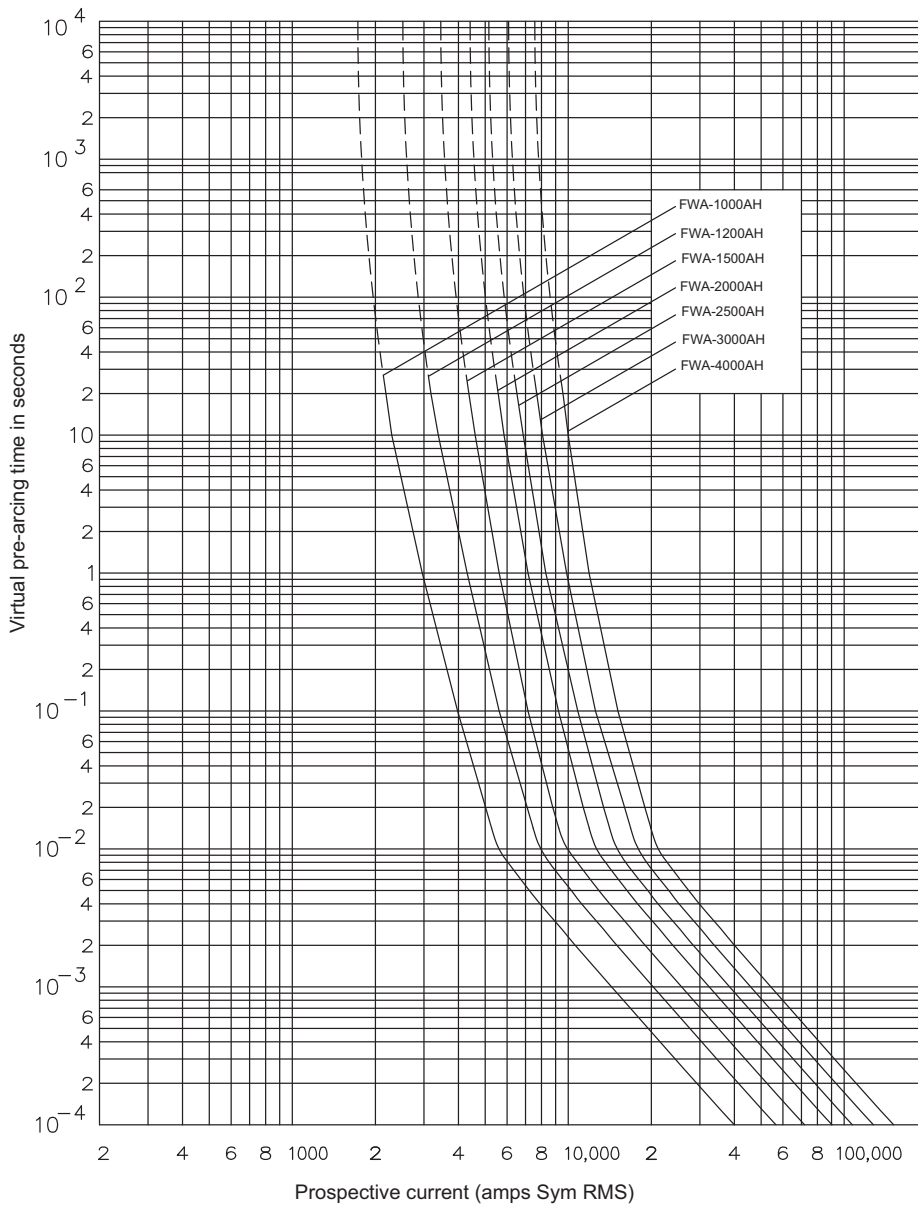

# North American fuse links

## FWA - 130 V a.c. / V d.c.(UL), 1000 A to 4000 A

### Cut-off curve - 1000 A to 4000 A

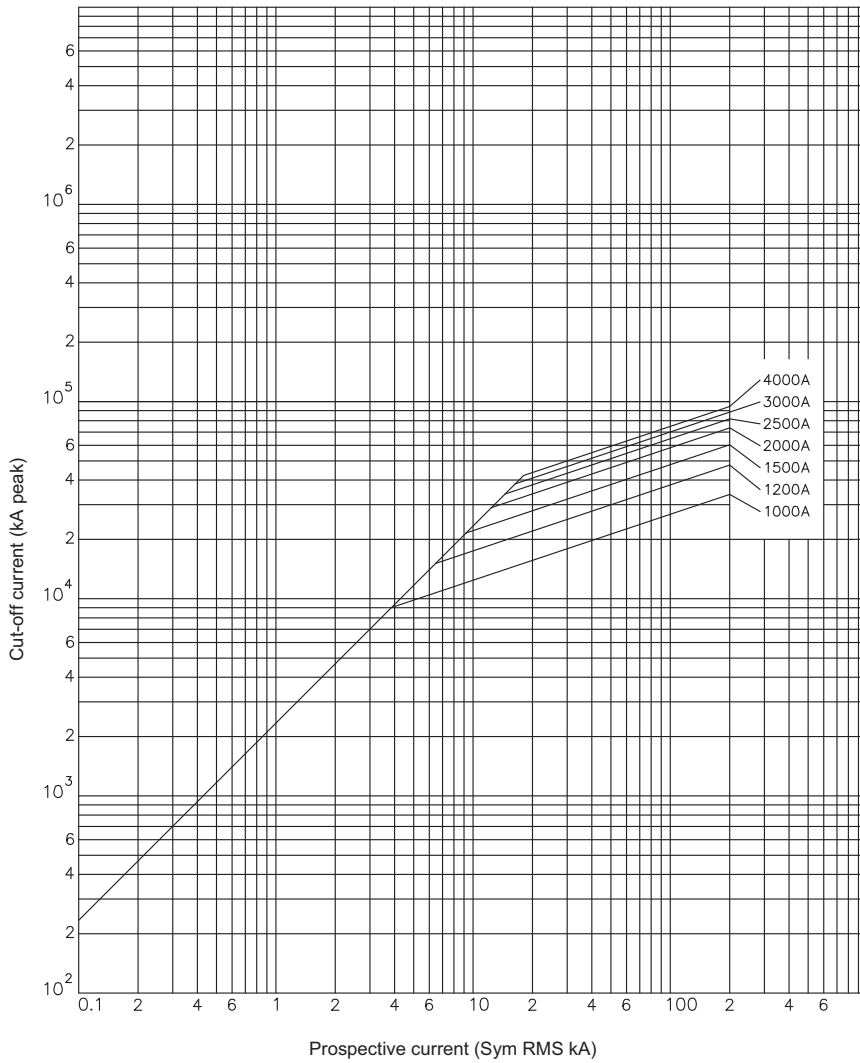

### Total clearing $I^2t$

The total clearing  $I^2t$  at rated voltage and at a power factor of 15 percent are given in the electrical characteristics. For other voltages, the clearing  $I^2t$  is found by multiplying by correction factor,  $K$ , given as a function of applied working voltage,  $E_g$ , (RMS).

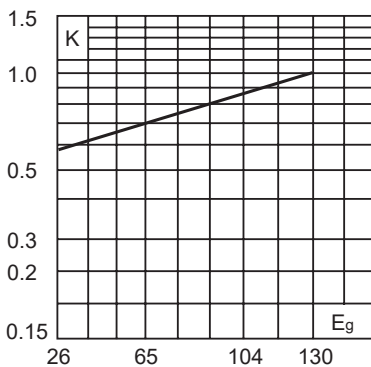

### Arc voltage

This curve gives the peak arc voltage,  $U_L$ , which may appear across the fuse during its operation as a function of the applied working voltage,  $E_g$ , (RMS) at a power factor of 15 percent.

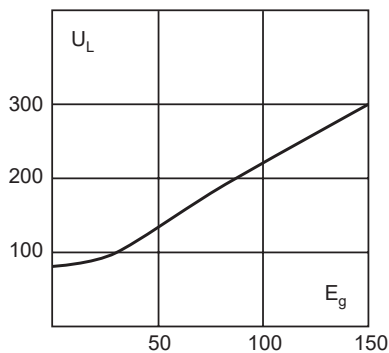

### Watts losses

Watts loss at rated current is given in the electrical characteristics. The curve allows the calculation of the watts losses at load currents lower than the rated current. The correction factor,  $K_p$ , is given as a function of the RMS load current,  $I_b$ , in percent of the rated current.

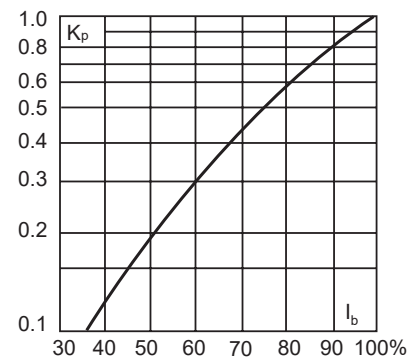



## FWA - 150 V a.c. / V d.c. (UL), 70 A to 1000 A

### Specifications

#### Description

North American style bolted tag high speed fuse links used for the protection of DC common bus, DC drives, power converters/rectifiers and reduced rated voltage starters.

#### Technical Data

- Rated voltage:
  - 150 V a.c. / V d.c. (UL)
  - 80 V d.c.
- Rated current: 70 A to 1000 A
- Breaking capacity:
  - 100 kA RMS Sym. (70 A to 400 A) at 150 V a.c.
  - 200 kA RMS Sym. (500 A to 1000 A) at 150 V a.c.
  - 20 kA at 150 V a.c. / V d.c. (70 A to 800 A)
  - 100 kA at 80 V d.c. (70 A to 1000 A)



#### Standards / Agency information

CE, UL Recognised JFHR2.E91958

#### Catalogue numbers

Rated voltage / Breaking capacity	Rated current (Amps)	I <sup>2</sup> t (A <sup>2</sup> Sec)		Watts loss (W)	Catalogue numbers
		Pre-arcing	Clearing at 150 V a.c.		
150 V a.c. / 100 kA	70	470	4000	6.9	FWA-70B
	80	670	6000	7.7	FWA-80B
	100	1200	12,000	9	FWA-100B
	125	1870	18,000	11.2	FWA-125B
	150	2700	26,000	13.5	FWA-150B
80 V d.c. / 100 kA	200	4780	45,000	17.6	FWA-200B
	250	7470	70,000	22.5	FWA-250B
150 V d.c. / 20 kA	300	10,760	100,000	27	FWA-300B
	350	15,700	140,000	30.6	FWA-350B
	400	20,300	180,000	35.2	FWA-400B
150 V a.c. / 200 kA	500	39,000	120,000	35	FWA-500A
	600	46,000	140,000	47	FWA-600A
80 V d.c. / 100 kA	700	75,000	220,000	49	FWA-700A
150 V d.c. / 20 kA	800	92,000	280,000	58	FWA-800A
150 V a.c. / 200 kA	1000	170,000	510,000	60	FWA-1000A
80 V d.c. / 100 kA					

# North American fuse links

## FWA - 150 V a.c. / V d.c. (UL), 70 A to 1000 A

### Dimensions (mm) - 70 A to 400 A

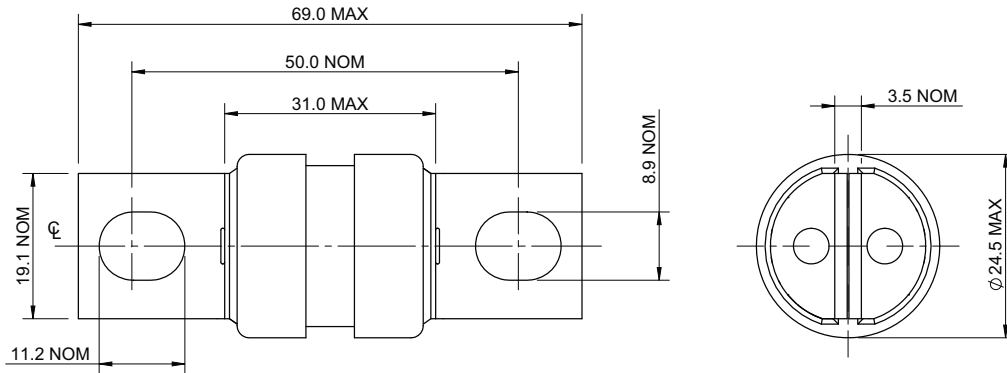

### Dimensions (mm) - 500 A to 1000 A

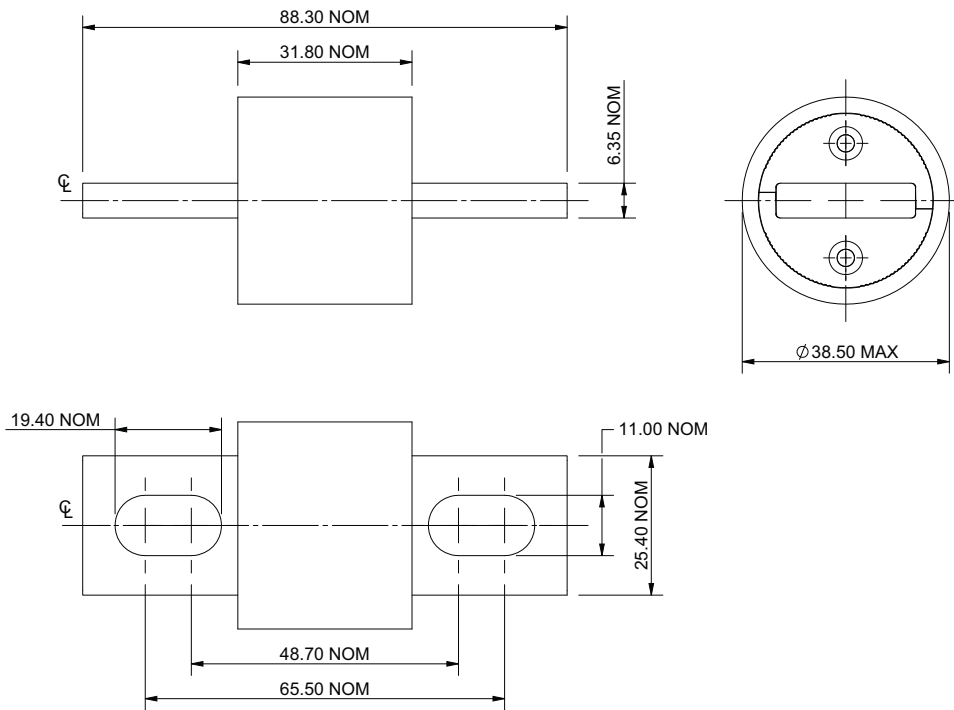

**FWA - 150 V a.c. / V d.c. (UL), 70 A to 1000 A**

**Time-current curve - 70 A to 1000 A**

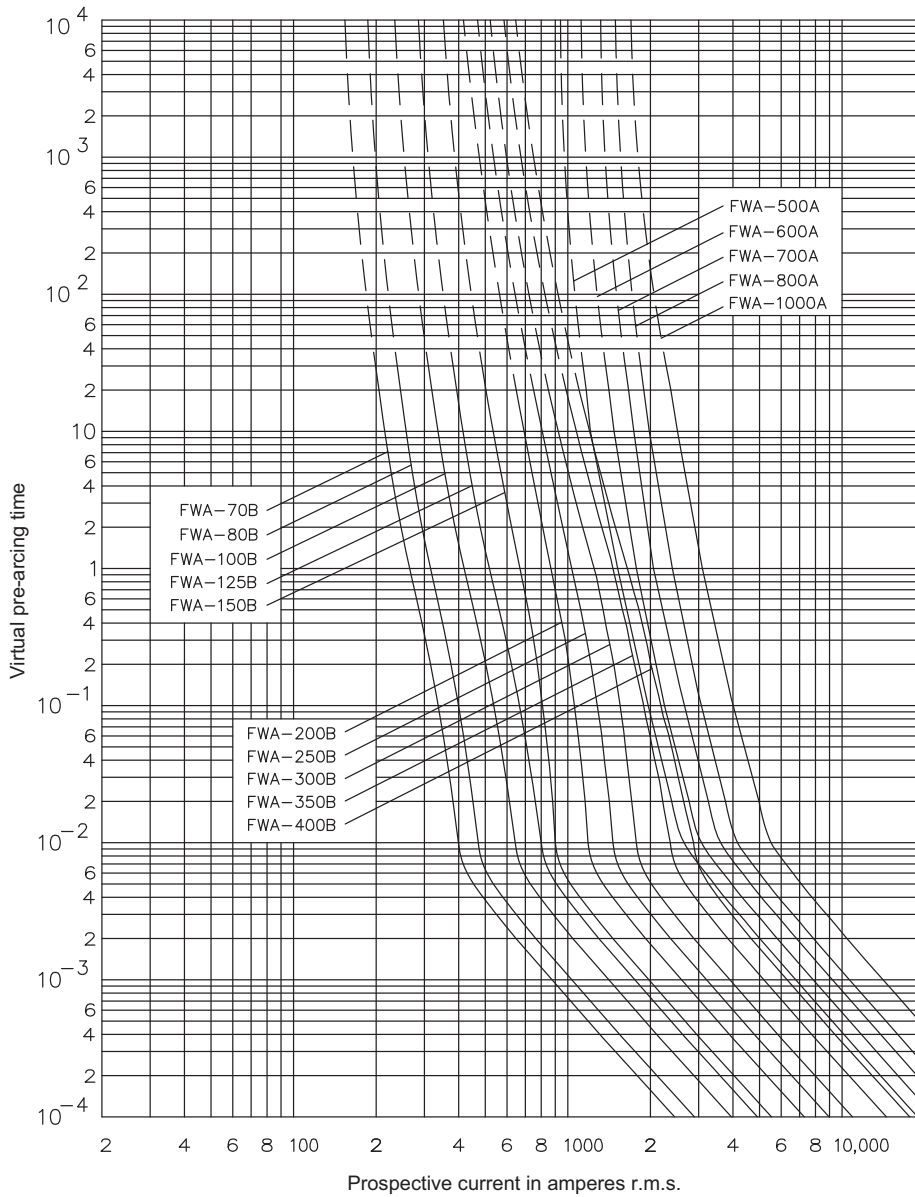

Data sheets: 720002, 5785310

# North American fuse links

## FWA - 150 V a.c. / V d.c. (UL), 70 A to 1000 A

### Cut-off curve - 70 A to 400 A

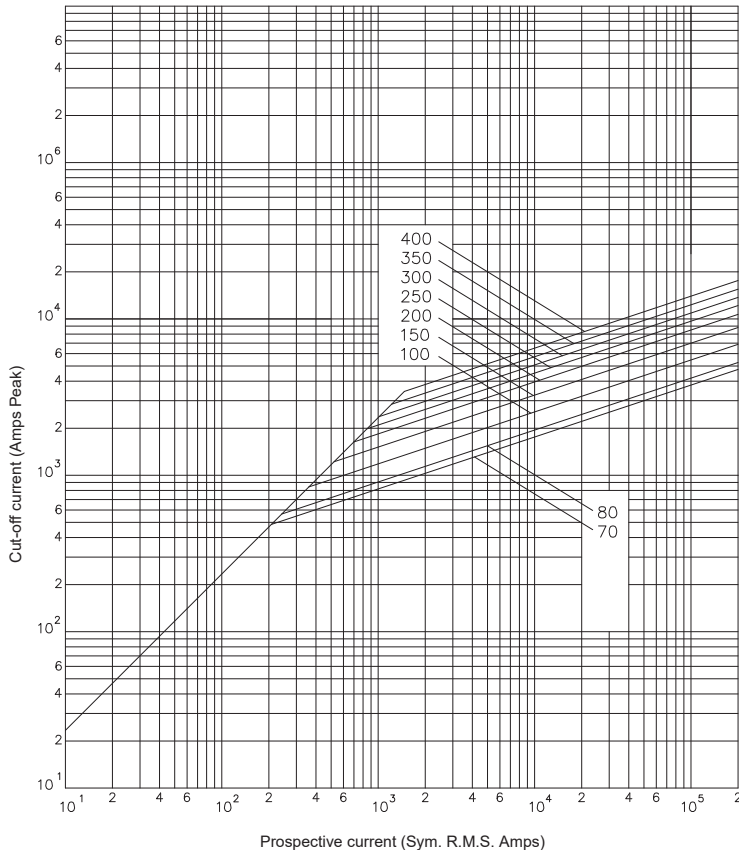

### Cut-off curve - 500 A to 1000 A

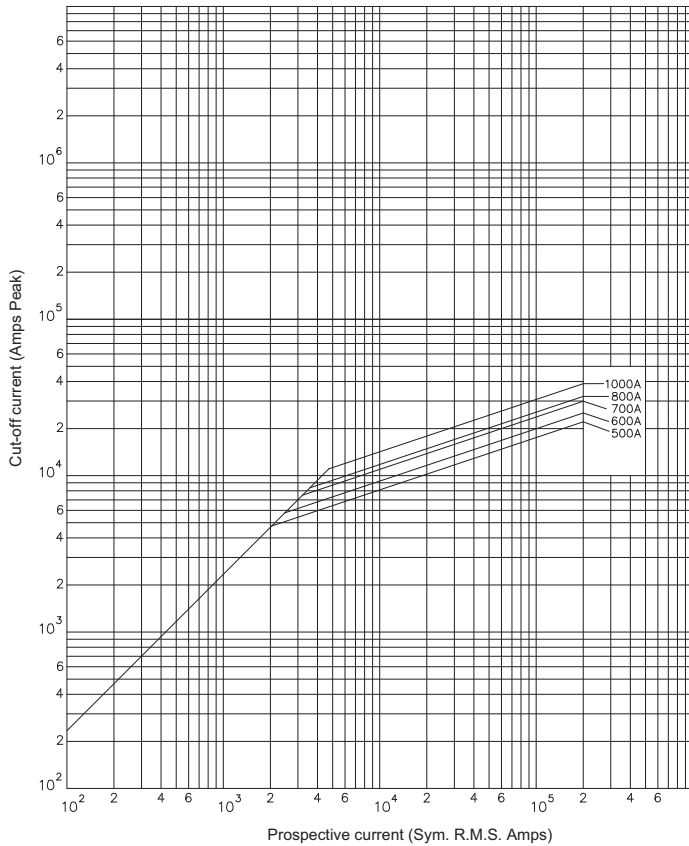

### Total clearing I<sup>2</sup>t

The total clearing I<sup>2</sup>t at rated voltage and at a power factor of 15 percent are given in the electrical characteristics. For other voltages, the clearing I<sup>2</sup>t is found by multiplying by correction factor, K, given as a function of applied working voltage, E<sub>g</sub>, (RMS).

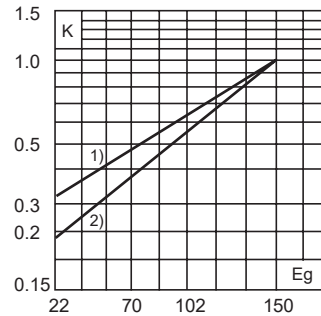

- 1) 500 - 1000 A
- 2) 70 - 400 A

### Arc voltage

This curve gives the peak arc voltage, U<sub>L</sub>, which may appear across the fuse during its operation as a function of the applied working voltage, E<sub>g</sub>, (RMS) at a power factor of 15 percent.

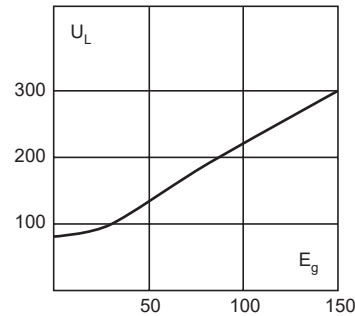

### Watts losses

Watts loss at rated current is given in the electrical characteristics. The curve allows the calculation of the watts losses at load currents lower than the rated current. The correction factor, K<sub>p</sub>, is given as a function of the RMS load current, I<sub>b</sub>, in percent of the rated current.

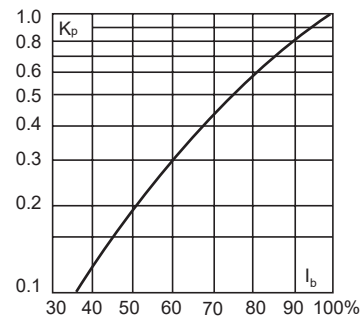

## FWX - 250 V a.c. / V d.c. (UL), 35 A to 2500 A

### Specifications

#### Description

North American style bolted tags and flush end high speed fuse links for the protection of DC common bus, DC drives, power converters/rectifiers and reduced rated voltage starters.

#### Technical Data

- Rated voltage: 250 V a.c. / V d.c. (UL)
- Rated current: 35 A to 2500 A
- Breaking capacity:
  - 200 kA RMS Sym.at 250 V a.c.
  - 50 kA at 250 V d.c. (35 A to 800 A)

#### Standards / Agency information

CE, UL Recognised file JFHR2.E56412 and CSA component acceptance on 35 A to 800 A fuse links (50 kA IR at 250 V d.c.)

#### Catalogue numbers

Rated voltage	Rated current (Amps)	Pt (A <sup>2</sup> Sec)		Watts loss (W)	Catalogue numbers
		Pre-arcing	Clearing at 250 V a.c.		
250 V a.c./ V d.c.(UL)	35	50	230	4.2	FWX-35A
250 V a.c./ V d.c.(UL)	40	60	310	5.2	FWX-40A
250 V a.c./ V d.c.(UL)	45	80	390	5.7	FWX-45A
250 V a.c./ V d.c.(UL)	50	100	520	6	FWX-50A
250 V a.c./ V d.c.(UL)	60	140	740	8.1	FWX-60A
250 V a.c./ V d.c.(UL)	70	330	1400	7.2	FWX-70A
250 V a.c./ V d.c.(UL)	80	430	1850	8.1	FWX-80A
250 V a.c./ V d.c.(UL)	90	570	2450	9	FWX-90A
250 V a.c./ V d.c.(UL)	100	740	3150	10	FWX-100A
250 V a.c./ V d.c.(UL)	125	1130	4850	12.5	FWX-125A
250 V a.c./ V d.c.(UL)	150	1620	6950	15.7	FWX-150A
250 V a.c./ V d.c.(UL)	175	2170	9300	18.5	FWX-175A
250 V a.c./ V d.c.(UL)	200	2790	12,000	22	FWX-200A
250 V a.c./ V d.c.(UL)	225	3210	14,700	24	FWX-225A
250 V a.c./ V d.c.(UL)	250	3960	18,100	27	FWX-250A
250 V a.c./ V d.c.(UL)	275	4720	21,600	31	FWX-275A
250 V a.c./ V d.c.(UL)	300	6000	27,300	32	FWX-300A
250 V a.c./ V d.c.(UL)	350	10,600	48,600	39	FWX-350A
250 V a.c./ V d.c.(UL)	400	14,500	66,100	44	FWX-400A
250 V a.c./ V d.c.(UL)	450	22,100	101,000	49	FWX-450A
250 V a.c./ V d.c.(UL)	500	28,000	128,000	54	FWX-500A
250 V a.c./ V d.c.(UL)	600	41,100	188,000	62	FWX-600A
250 V a.c./ V d.c.(UL)	700	48,800	190,000	72	FWX-700A
250 V a.c./ V d.c.(UL)	800	59,000	230,000	84	FWX-800A
250 V a.c./ V d.c.(UL)	1000	44,000	360,000	100	FWX-1000AH
250 V a.c./ V d.c.(UL)	1200	92,000	750,000	103	FWX-1200AH
250 V a.c./ V d.c.(UL)	1500	120,000	880,000	140	FWX-1500AH
250 V a.c./ V d.c.(UL)	1600	160,000	1,200,000	140	FWX-1600AH
250 V a.c./ V d.c.(UL)	2000	320,000	2,300,000	151	FWX-2000AH
250 V a.c./ V d.c.(UL)	2500	670,000	4,700,000	163	FWX-2500AH



Data sheets: 720005, 359 (35-800 A), 5785299 (100-2500 A)

# North American fuse links

## FWX - 250 V a.c. / V d.c. (UL), 35 A to 2500 A

### Dimensions (in)

#### 35 A to 800 A

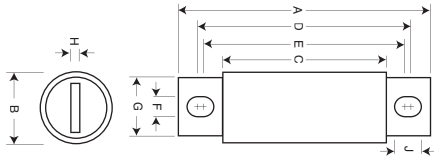

#### 1000 A to 1200 A

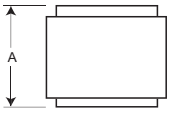

#### 1500 A to 2500 A

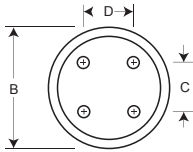
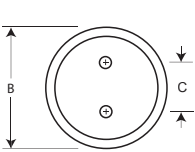
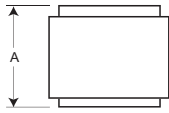

Amp range	A	B	C	D	E	F	G	H	J	Tapped thread depth
35-60	3.19	0.81	1.59	2.59	2.25	0.34	0.63	0.13	0.52	-
70-200	3.13	1.22	1.59	2.44	2.19	0.34	1	0.19	0.47	-
225-600	3.84	1.5	1.59	2.94	2.25	0.41	1	0.25	0.75	-
700-800	3.84	2	1.59	3.03	2.28	0.41	1.5	0.25	0.78	-
1000-1200	2.59	3	1.5	-	-	-	-	-	-	3/8"-24 x
1500-2500	2.59	3.5	1.5	1.5	-	-	-	-	-	1/2" UNF

1" = 25.4mm

### Time-current curve - 35 A to 800 A

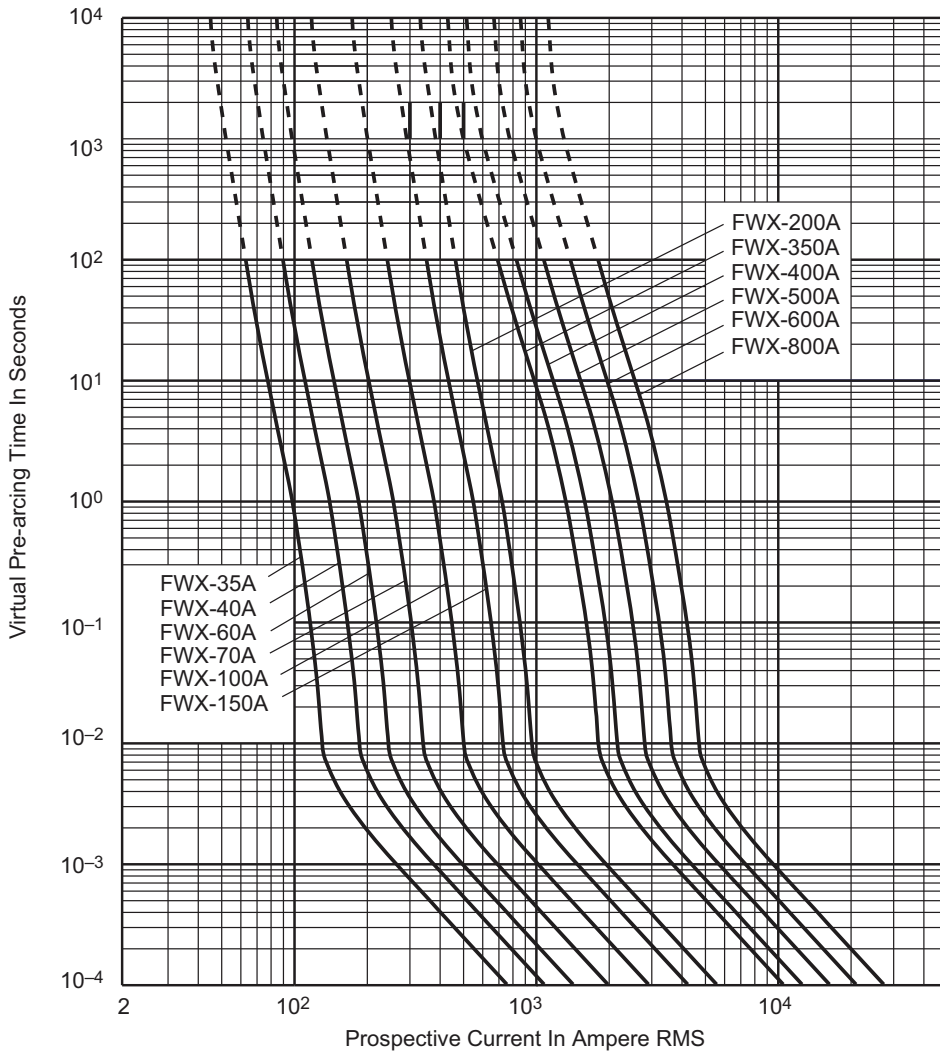

Contact [FUSETECH@eaton.com](mailto:FUSETECH@eaton.com) for the time current curves for the following ratings: 45, 50, 80, 90, 125, 175, 225, 250, 275, 300, 450 and 700 A

Data sheets: 720005, 359 (35-800 A), 5785299 (100-2500 A)

**FWX - 250 V a.c. / V d.c. (UL), 35 A to 2500 A**

**Time-current curve - 1000 A to 2500 A**

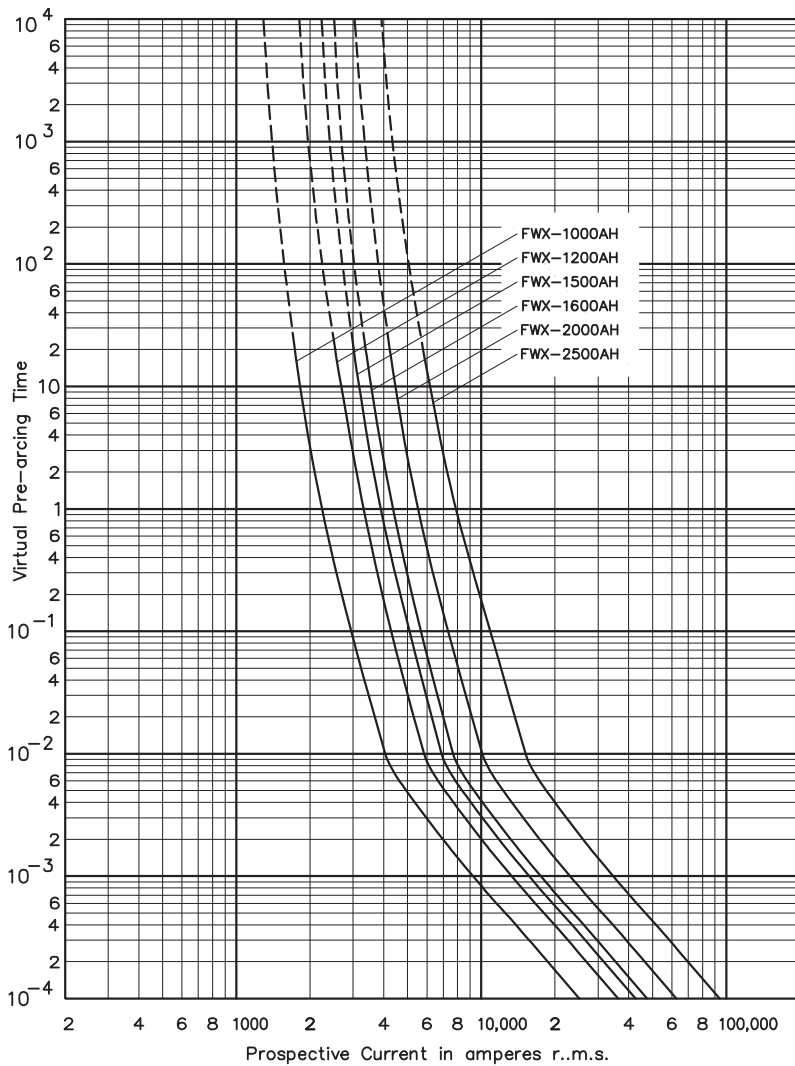

**Total clearing I<sup>2</sup>t**

The total clearing I<sup>2</sup>t at rated voltage and at a power factor of 15 percent are given in the electrical characteristics. For other voltages, the clearing I<sup>2</sup>t is found by multiplying by correction factor, K, given as a function of applied working voltage, E<sub>g</sub>, (RMS).

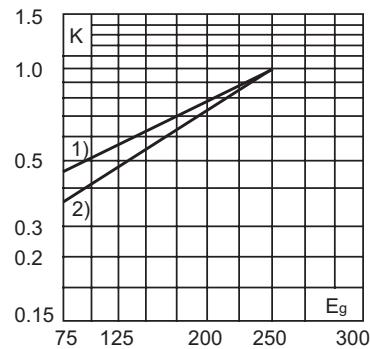

- 1) 35 - 800 Amps
- 2) 1000 - 2500 Amps

**Arc voltage**

This curve gives the peak arc voltage, U<sub>L</sub>, which may appear across the fuse during its operation as a function of the applied working voltage, E<sub>g</sub>, (RMS) at a power factor of 15 percent.

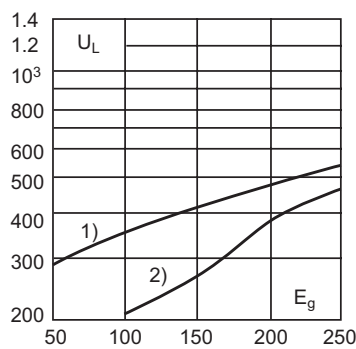

- 1) 35 - 800 Amps
- 2) 1000 - 2500 Amps

**Watts losses**

Watts loss at rated current is given in the electrical characteristics. The curve allows the calculation of the watts losses at load currents lower than the rated current. The correction factor, K<sub>p</sub>, is given as a function of the RMS load current, I<sub>b</sub>, in percent of the rated current.

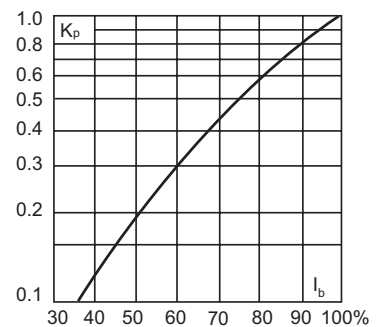

Data sheets: 720005, 359 (35-800 A), 5785299 (100-2500 A)

# North American fuse links

## CHSF - 500 V a.c. / V d.c. (UL), 50 A to 400 A

### Specifications

#### Description

Eaton's Bussmann series compact high speed fuses feature space-saving case sizes for protecting semiconductor devices up to 500 V a.c./V d.c. in ratings from 50 to 400 Amps

#### Technical Data

- Rated voltage: 500 V a.c. / V d.c. (UL)
- Rated current: 50 A to 400 A
- Breaking capacity:
  - Maximum AC: 200 kA / Minimum AC 400%
  - Maximum DC: 50 kA / Minimum DC 800%
- Conforms to IEC aR specifications for short-circuit protection



#### Standards / Agency information

UL Recognised, File E56412, guide JFHR2, CSA Component Acceptance, Class 1422-30, File 53787, IEC aR (self-certified), CE, RoHS compliant, REACH declaration available upon request

#### Catalogue numbers

Rated voltage	Rated current (Amps)	I <sup>2</sup> t (A <sup>2</sup> Sec)			Watts loss (W) at 80%	Catalogue numbers
		AC/DC Pre-arcing	AC clearing at 200 kA/500 V a.c.	DC clearing at 50 kA/500 V d.c.		
500 V a.c./ V d.c.(UL)	50	304	1875	935	3.8	CHSF-50
500 V a.c./ V d.c.(UL)	60	438	2700	1346	4.5	CHSF-60
500 V a.c./ V d.c.(UL)	70	596	3675	1833	5.3	CHSF-70
500 V a.c./ V d.c.(UL)	80	778	4800	2394	6.1	CHSF-80
500 V a.c./ V d.c.(UL)	100	1216	7500	3740	7.6	CHSF-100
500 V a.c./ V d.c.(UL)	125	2042	12721	6465	12	CHSF-125
500 V a.c./ V d.c.(UL)	150	2941	18318	9309	14.3	CHSF-150
500 V a.c./ V d.c.(UL)	175	4003	24933	12671	16.7	CHSF-175
500 V a.c./ V d.c.(UL)	200	5228	32566	16550	19.1	CHSF-200
500 V a.c./ V d.c.(UL)	225	6835	48028	21278	26.1	CHSF-225
500 V a.c./ V d.c.(UL)	250	8438	59293	26270	29	CHSF-250
500 V a.c./ V d.c.(UL)	300	12151	85382	37828	34.8	CHSF-300
500 V a.c./ V d.c.(UL)	350	16539	116215	51488	40.6	CHSF-350
500 V a.c./ V d.c.(UL)	400	21603	151791	67250	46.4	CHSF-400

#### Dimensions (mm) - 50 A to 400 A

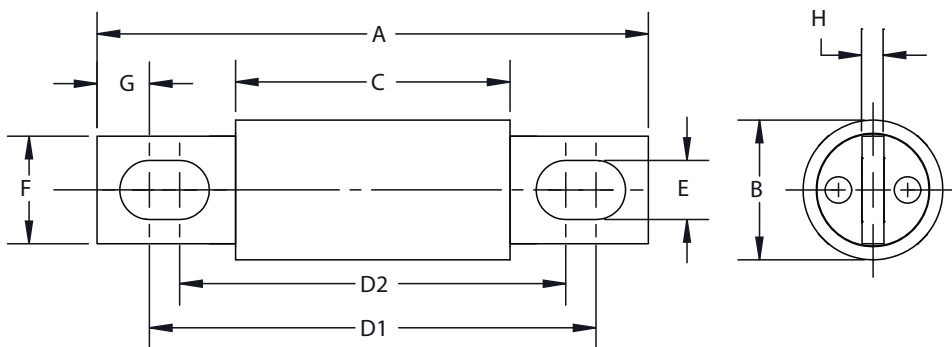

Amps	A	B	C	D1	D2	E	F	G	H
50-100	81	20	40	61	58	8.7	16	7.7	3.2
125-200	92	25	53	77	68	8.7	19	7.8	3.2
225-400	92	30	53	74	68	8.7	25	9	4.8

Data sheet: 10414



**CHSF - 500 V a.c. / V d.c. (UL), 50 A to 400 A**

**AC Minimum melt curve - 50 A to 400 A**

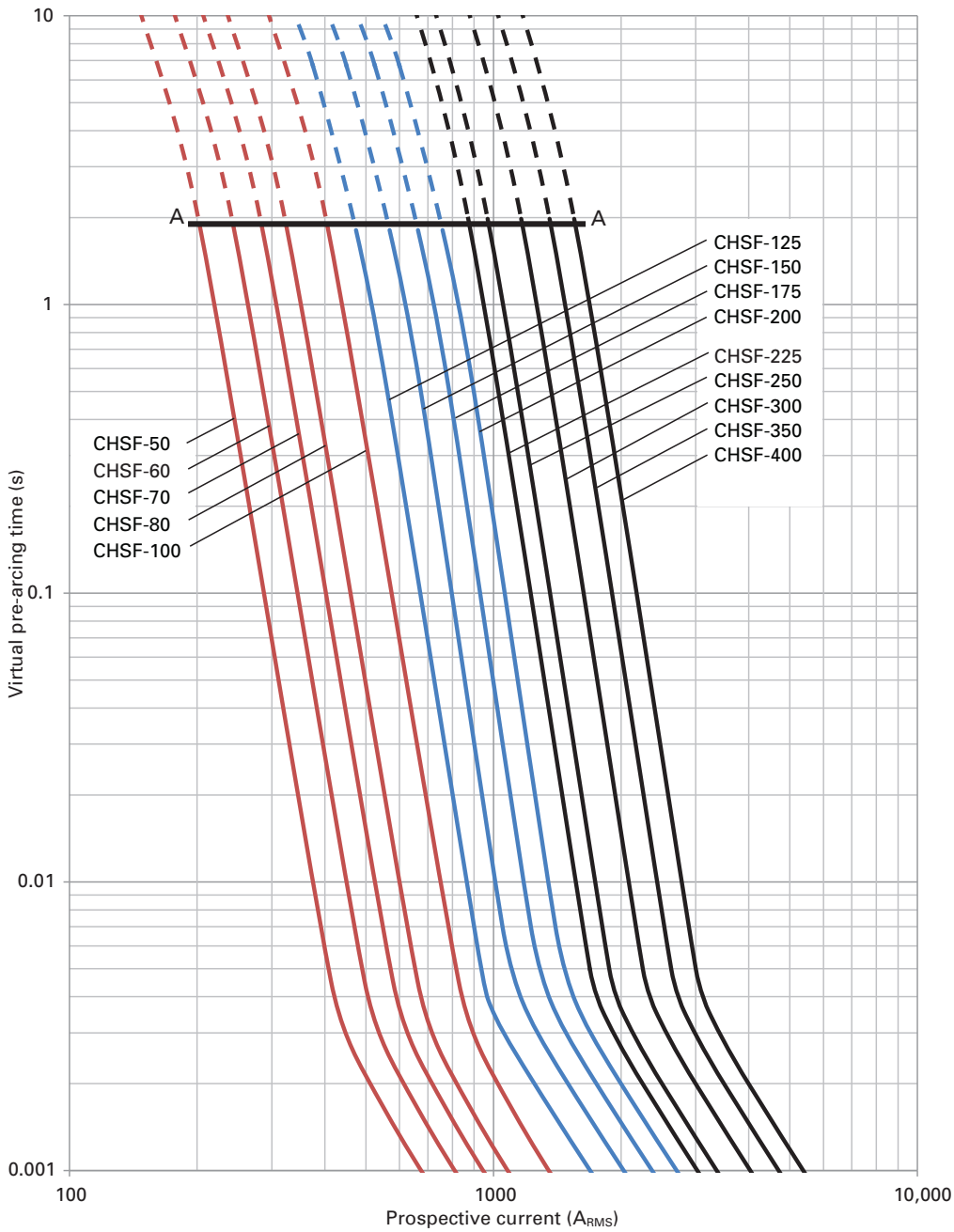

# North American fuse links

## CHSF - 500 V a.c. / V d.c. (UL), 50 A to 400 A

### AC Time-current curve- 50 A to 400 A

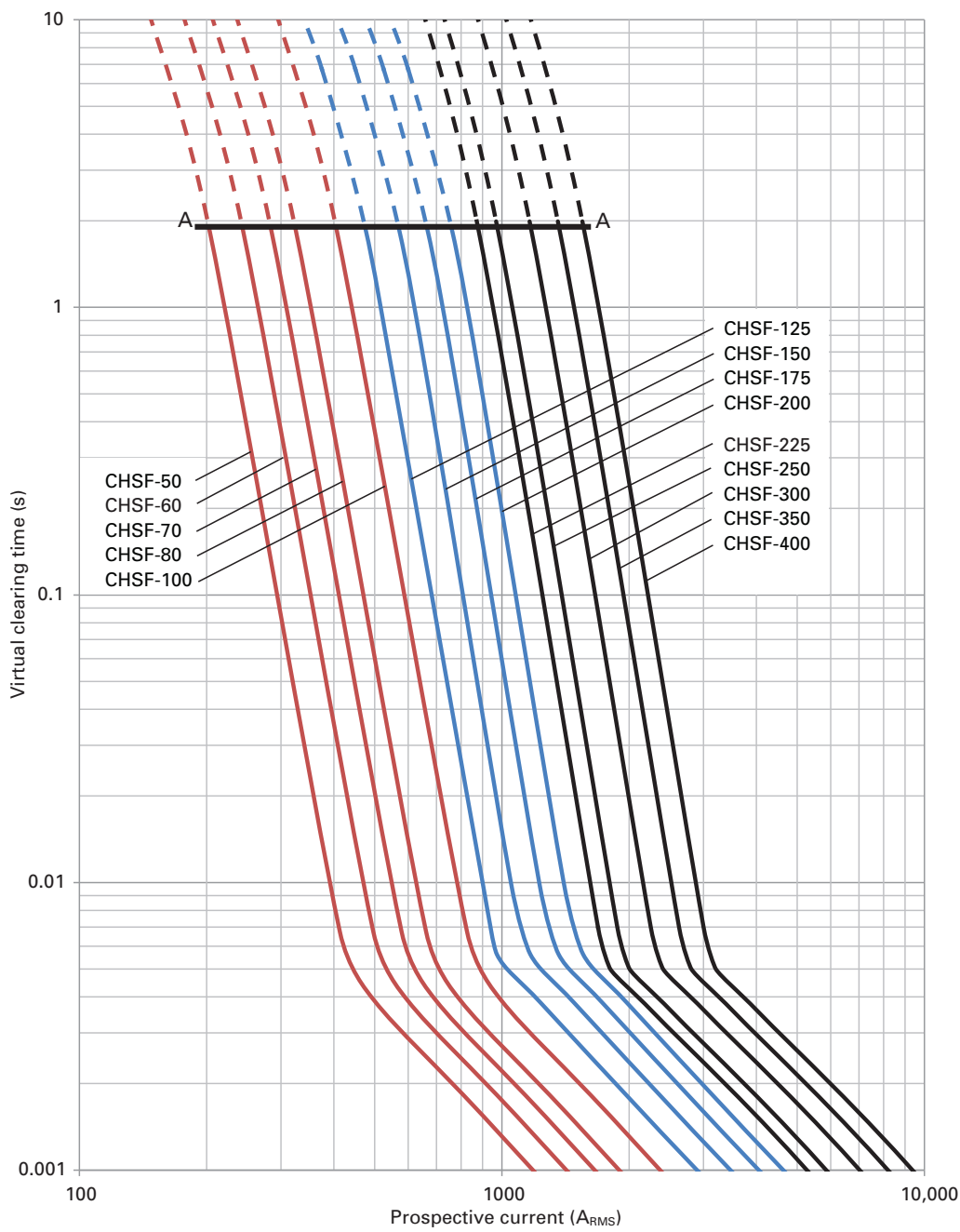

# CHSF - 500 V a.c. / V d.c. (UL), 50 A to 400 A

AC Cut-off curve - 50 A to 400 A

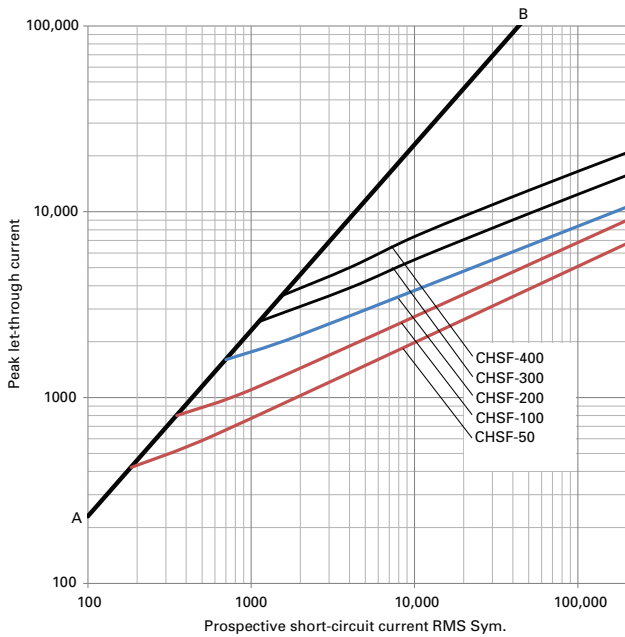

AC Arc Voltage

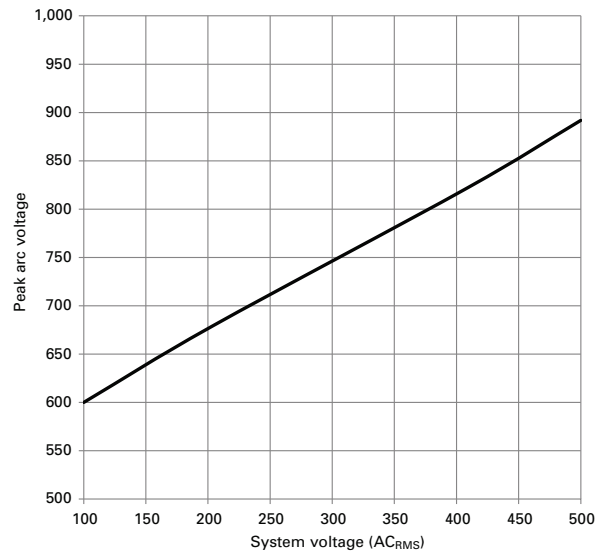

AC clearing I<sup>2</sup>t voltage correction factor

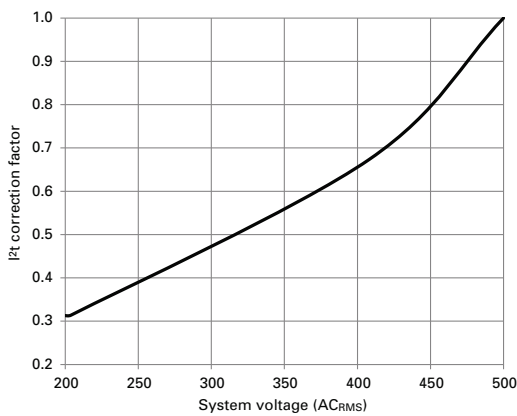

DC Arc voltage

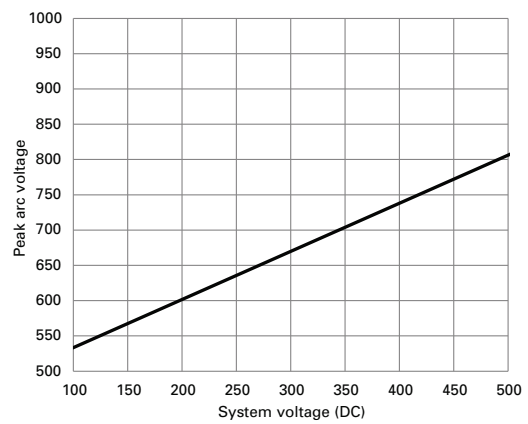

DC clearing I<sup>2</sup>t voltage correction factor

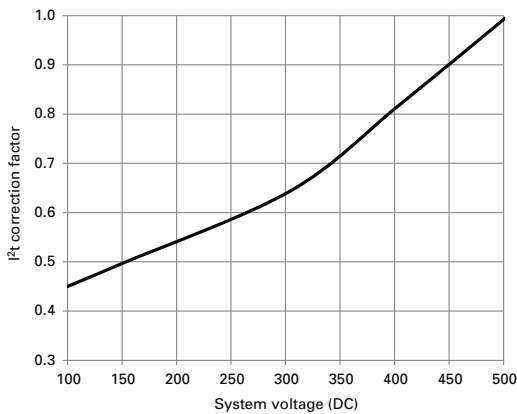

Temperature derating

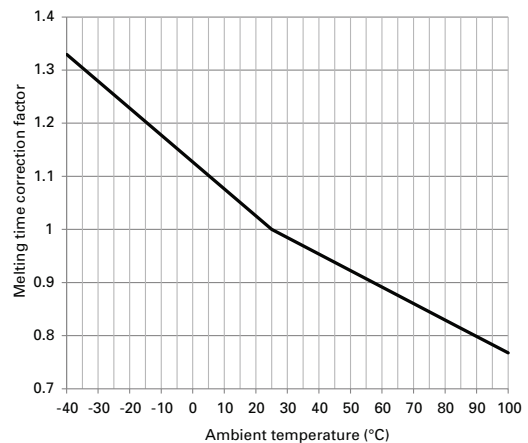

Data sheet: 10414

# North American fuse links

## FWH - 500 V a.c. / V d.c. (UL), 35 A to 1600 A

### Specifications

#### Description

North American style bolted tags high speed fuse links, for the protection of DC common bus, power converters/rectifiers and reduced rated voltage starters.

#### Technical data

- Rated voltage:
  - 500 V a.c. (UL)
  - 500 V d.c. (35 A to 800 A only)
- Rated current: 35 A to 1600 A
- Breaking capacity:
  - 200 kA RMS Sym.
  - 50 kA at 500 V d.c.

#### Standards / Agency information

CE, UL Recognition JFHR2.E91958 FWH\_B (35 A to 200 A), JFHR2.E56412 FWH\_A (225 A to 800 A), CSA Component Acceptance Class 1422-30, File 53787 (35 A to 1600 A)



#### Catalogue numbers

Rated voltage	Rated current (Amps)	I <sup>2</sup> t (A <sup>2</sup> Sec)		Watts loss (W)	Catalogue numbers
		Pre-arcing	Clearing at 500 V a.c.		
500 V a.c./V d.c. (UL)	35	34	150	8	FWH-35B
500 V a.c./V d.c. (UL)	40	76	320	7.5	FWH-40B
500 V a.c./V d.c. (UL)	45	105	450	7.5	FWH-45B
500 V a.c./V d.c. (UL)	50	135	670	7.5	FWH-50B
500 V a.c./V d.c. (UL)	60	210	900	9.9	FWH-60B
500 V a.c./V d.c. (UL)	70	210	900	10.6	FWH-70B
500 V a.c./V d.c. (UL)	80	305	1400	12.7	FWH-80B
500 V a.c./V d.c. (UL)	90	360	1600	15	FWH-90B
500 V a.c./V d.c. (UL)	100	475	2000	17	FWH-100B
500 V a.c./V d.c. (UL)	125	800	3500	25	FWH-125B
500 V a.c./V d.c. (UL)	150	1100	4600	30	FWH-150B
500 V a.c./V d.c. (UL)	175	1450	6200	35	FWH-175B
500 V a.c./V d.c. (UL)	200	1900	8500	40	FWH-200B
500 V a.c./V d.c. (UL)	225	4600	23,300	39	FWH-225A
500 V a.c./V d.c. (UL)	250	6300	32,200	41	FWH-250A
500 V a.c./V d.c. (UL)	275	7900	40,300	46	FWH-275A
500 V a.c./V d.c. (UL)	300	9800	49,800	51	FWH-300A
500 V a.c./V d.c. (UL)	325	13,700	63,800	53	FWH-325A
500 V a.c./V d.c. (UL)	350	14,500	72,900	58	FWH-350A
500 V a.c./V d.c. (UL)	400	19,200	96,700	65	FWH-400A
500 V a.c./V d.c. (UL)	450	24,700	127,000	74	FWH-450A
500 V a.c./V d.c. (UL)	500	29,200	149,000	84	FWH-500A
500 V a.c./V d.c. (UL)	600	41,300	206,000	108	FWH-600A
500 V a.c./V d.c. (UL)	700	55,000	298,000	120	FWH-700A
500 V a.c./V d.c. (UL)	800	76,200	409,000	129	FWH-800A
500 V a.c./V d.c. (UL)	900	74,000	363,000	132	FWH-900A
500 V a.c. (UL)	1000	92,000	450,000	145	FWH-1000B
500 V a.c. (UL)	1200	122,000	600,000	180	FWH-1200B
500 V a.c. (UL)	1400	200,000	1,000,000	210	FWH-1400A
500 V a.c. (UL)	1600	290,000	1,400,000	230	FWH-1600A

Data sheets: 720007, 360 (350-800 A), 5785304 (35-200 A, 1000-1600 A)

**FWH - 500 V a.c. / V d.c. (UL), 35 A to 1600 A**

Dimensions (in) - 35 A to 1200 A

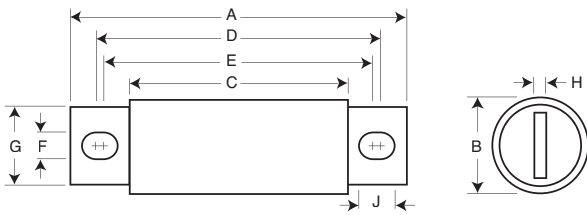

Dimensions (in) - 1400 A and 1600 A

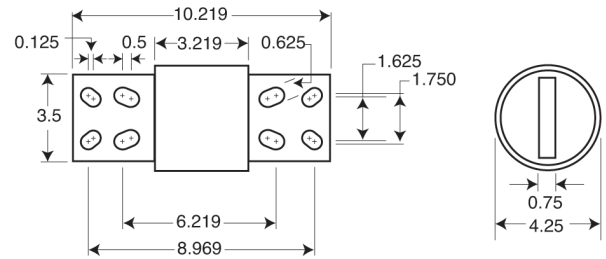

Amp range	A	B	C	D	E	F	G	H	J
35-60	3.19	0.81	1.59	2.54	2.19	0.34	0.72	0.13	0.52
70-100	3.62	0.95	1.74	2.85	2.81	0.35	0.75	0.13	0.38
125-200	3.62	1.16	1.84	2.89	2.77	0.34	1	0.19	0.41
225-400	4.34	1.5	2.09	3.44	2.75	0.41	1	0.25	0.75
450-600	4.34	2	2.09	3.53	2.78	0.41	1.5	0.25	0.78
700-800	6.34	2.5	2.09	4.97	3.44	0.53	2	0.38	1.30
1000-1200	6.97	3	3.22	5.47	4.48	0.62	2.38	0.44	1.12

1" = 25.4mm

Time-current curve - 35 A to 200 A and 900 A to 1600 A

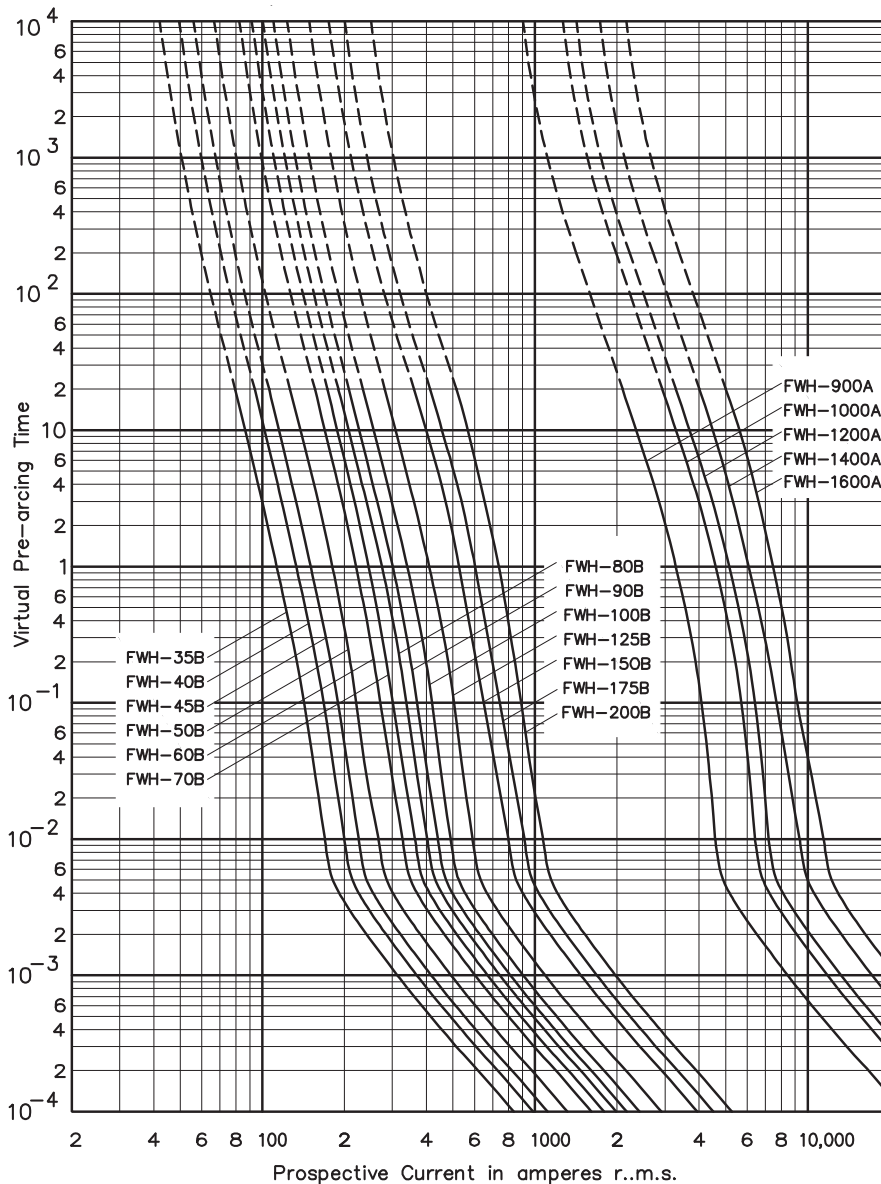

Data sheets: 720007, 360 (350-800 A), 5785304 (35-200 A, 1000-1600 A)

# North American fuse links

## FWH - 500 V a.c. / V d.c. (UL), 35 A to 1600 A

### Time-current curve - 350 A to 800 A

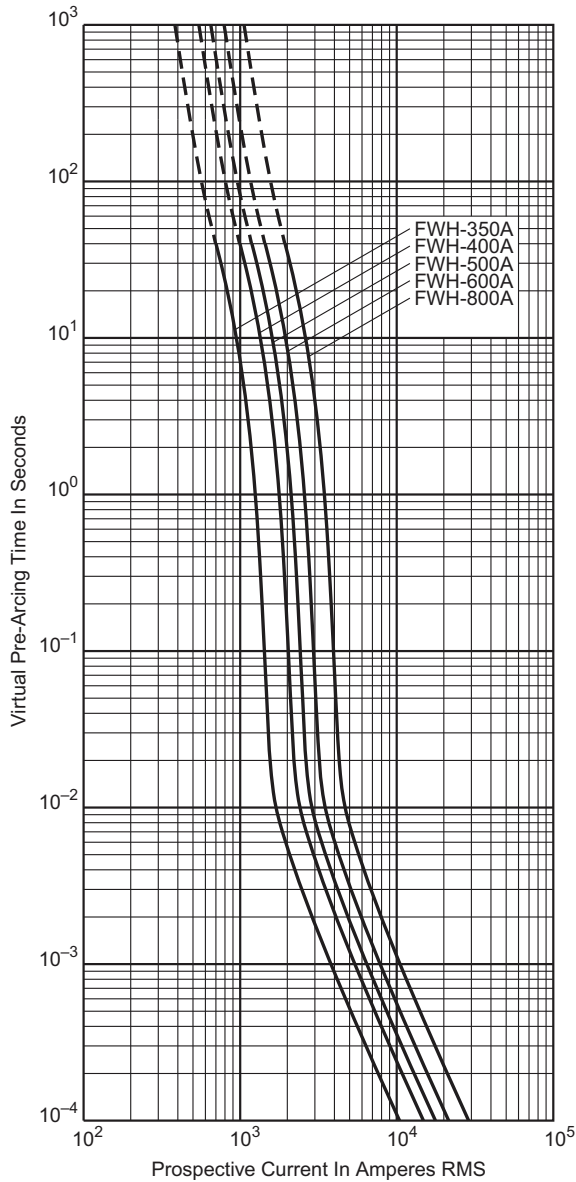

Contact [FUSETECH@eaton.com](mailto:FUSETECH@eaton.com) for the time current curves for the following ratings: 225 to 325 A, 450 A and 700 A

### Total clearing I<sup>2</sup>t

The total clearing I<sup>2</sup>t at rated voltage and at a power factor of 15 percent are given in the electrical characteristics. For other voltages, the clearing I<sup>2</sup>t is found by multiplying by correction factor, K, given as a function of applied working voltage, E<sub>g</sub>, (RMS).

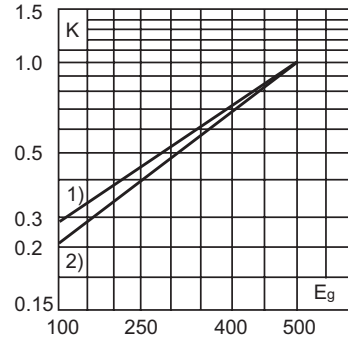

- 1) 35 - 800 A
- 2) 1000 - 1600 A

### Arc voltage

This curve gives the peak arc voltage, U<sub>L</sub>, which may appear across the fuse during its operation as a function of the applied working voltage, E<sub>g</sub>, (RMS) at a power factor of 15 percent.

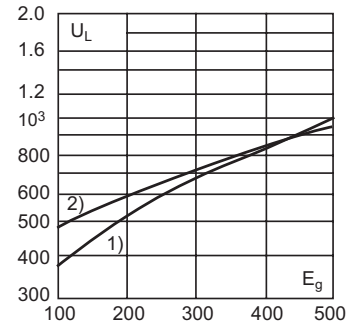

- 1) 35 - 200 A and 1000 - 1600 A
- 2) 225 - 800 A

### Watts losses

Watts loss at rated current is given in the electrical characteristics. The curve allows the calculation of the watts losses at load currents lower than the rated current. The correction factor, K<sub>p</sub>, is given as a function of the RMS load current, I<sub>b</sub>, in percent of the rated current.

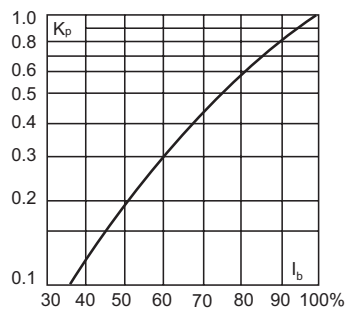

## KAC - 600 V a.c. (UL), 1 A to 1000 A

### Specifications

#### Description

North American style bolted tags high speed fuse links. These fuse links are supplied as replacements only. For new installations, Eaton recommends the 700 V FWP fuse links.

#### Technical Data

- Rated voltage: 600 V a.c. (UL)
- Rated current: 1 A to 1000 A
- Breaking capacity: 200 kA RMS Sym.

#### Standards / Agency information

CE, UL file JFHR2.E56413 (1 A to 600 A only)

#### Catalogue numbers

Rated voltage	Rated current (Amps)	Catalogue numbers
600 V a.c. (UL)	1	KAC-1
600 V a.c. (UL)	2	KAC-2
600 V a.c. (UL)	3	KAC-3
600 V a.c. (UL)	4	KAC-4
600 V a.c. (UL)	5	KAC-5
600 V a.c. (UL)	6	KAC-6
600 V a.c. (UL)	7	KAC-7
600 V a.c. (UL)	8	KAC-8
600 V a.c. (UL)	9	KAC-9
600 V a.c. (UL)	10	KAC-10
600 V a.c. (UL)	12	KAC-12
600 V a.c. (UL)	15	KAC-15
600 V a.c. (UL)	17.5	KAC-17.5
600 V a.c. (UL)	20	KAC-20
600 V a.c. (UL)	25	KAC-25
600 V a.c. (UL)	30	KAC-30
600 V a.c. (UL)	35	KAC-35
600 V a.c. (UL)	40	KAC-40
600 V a.c. (UL)	45	KAC-45
600 V a.c. (UL)	50	KAC-50
600 V a.c. (UL)	60	KAC-60
600 V a.c. (UL)	70	KAC-70
600 V a.c. (UL)	80	KAC-80
600 V a.c. (UL)	90	KAC-90
600 V a.c. (UL)	100	KAC-100
600 V a.c. (UL)	110	KAC-110
600 V a.c. (UL)	125	KAC-125
600 V a.c. (UL)	150	KAC-150
600 V a.c. (UL)	175	KAC-175
600 V a.c. (UL)	200	KAC-200
600 V a.c. (UL)	225	KAC-225
600 V a.c. (UL)	250	KAC-250
600 V a.c. (UL)	300	KAC-300
600 V a.c. (UL)	350	KAC-350
600 V a.c. (UL)	400	KAC-400
600 V a.c. (UL)	450	KAC-450
600 V a.c. (UL)	500	KAC-500
600 V a.c. (UL)	600	KAC-600
600 V a.c. (UL)	700	KAC-700
600 V a.c. (UL)	800	KAC-800
600 V a.c. (UL)	1000	KAC-1000



#### Dimensions (in) - 1 A to 30 A and 450 A to 1000 A

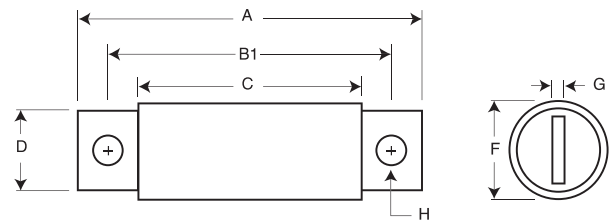

Rated current (Amps)	A	B1	B2	B3	C	D	E	F	G	H
1-30	2.88	2.5	-	-	1.88	0.41	-	0.56	0.06	0.26
450-800	6.25	4.75	-	-	3.06	2	-	2.5	0.25	0.56
1000	7.25	4.75	-	-	3.06	2.75	-	3.5	0.38	0.56

1" = 25.4mm

#### Dimensions (in) - 35 A to 400 A

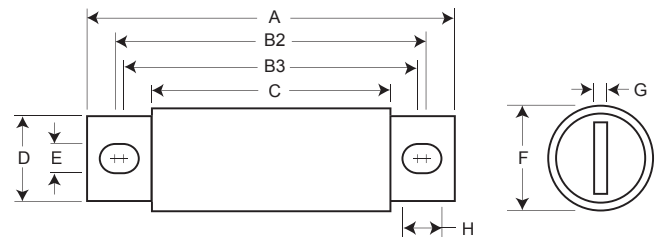

Rated current (Amps)	A	B1	B2	B3	C	D	E	F	G	H
35-60	4.38	-	3.75	3.50	2.75	0.63	0.34	0.81	0.09	0.47
70-100	5	-	4.06	3.66	2.75	0.75	0.41	1	0.13	0.61
110-200	5.14	-	4.39	3.77	2.91	1	0.41	1.5	0.19	0.72
225-400	6.18	-	4.82	4.57	3	1.63	0.56	2	0.25	0.69

1" = 25.4mm

# North American fuse links

## KBC - 600 V a.c. (UL), 35 A to 800 A

### Specifications

#### Description

North American style bolted tags and flush-end high speed fuse links. These fuse links are supplied as replacements only. For new installations, Eaton recommends the 700 V FWP fuse links.

#### Technical data

- Rated voltage: 600 V a.c. (UL)
- Rated current: 35 A to 800 A
- Breaking capacity: 100 kA RMS Sym.

#### Standards / Agency information

CE, UL file JFHR2.E56412 (35 A to 600 A only)

#### Catalogue numbers

Rated voltage	Rated current (Amps)	Catalogue numbers
600 V a.c. (UL)	35	KBC-35
600 V a.c. (UL)	40	KBC-40
600 V a.c. (UL)	45	KBC-45
600 V a.c. (UL)	50	KBC-50
600 V a.c. (UL)	60	KBC-60
600 V a.c. (UL)	70	KBC-70
600 V a.c. (UL)	80	KBC-80
600 V a.c. (UL)	90	KBC-90
600 V a.c. (UL)	100	KBC-100
600 V a.c. (UL)	110	KBC-110
600 V a.c. (UL)	125	KBC-125
600 V a.c. (UL)	150	KBC-150
600 V a.c. (UL)	175	KBC-175
600 V a.c. (UL)	200	KBC-200
600 V a.c. (UL)	225	KBC-225
600 V a.c. (UL)	250	KBC-250
600 V a.c. (UL)	300	KBC-300
600 V a.c. (UL)	350	KBC-350
600 V a.c. (UL)	400	KBC-400
600 V a.c. (UL)	450	KBC-450
600 V a.c. (UL)	600	KBC-600
600 V a.c. (UL)	800	KBC-800



#### Dimensions (in) - 35 A to 60 A and 110 A to 600 A

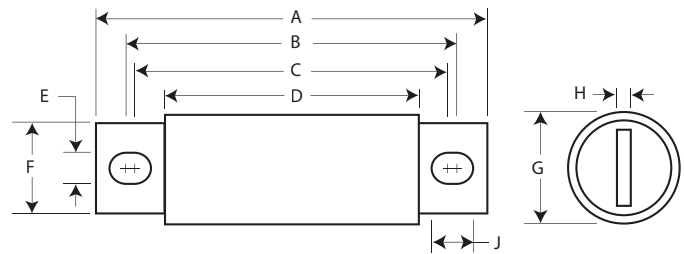

Rated current (Amps)	A	B	C	D	E	F	G	H	J
35-60	4.38	3.75	3.50	2.75	0.34	0.63	0.81	0.09	0.47
110-200	4.41	3.72	3.59	2.91	0.31	0.88	1.22	0.19	0.38
225-400	5.13	4.19	3.56	2.91	0.41	1	1.5	0.25	0.72
450-600	5.13	4.39	3.69	2.88	0.41	1.5	2	0.25	0.76

1" = 25.4mm

#### Dimensions (in) - 70 A to 100 A

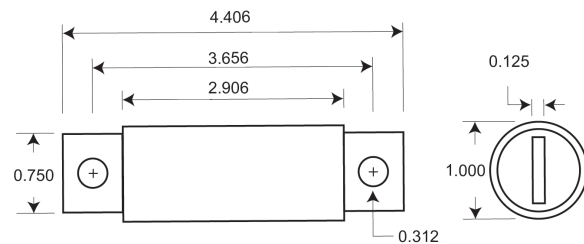

#### Dimensions (in) - 800 A

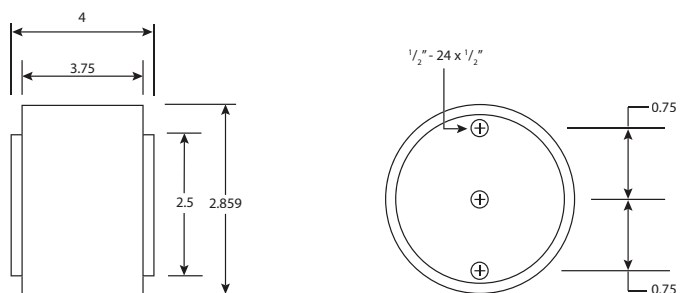



## FWP - 700 V a.c. / V d.c.(UL), 5 A to 1200 A

### Specifications

#### Description

North American style bolted tags high speed fuse links for the protection of DC common bus, DC drives, power converters/rectifiers, reduced rated voltage starters.

#### Technical data

- Rated voltage: 700 V a.c. / V d.c. (UL)
- Rated current: 5 A to 1200 A
- Breaking capacity: see details in table below

#### Standards / Agency information

CE, UL Recognition JFHR2.E91958 FWP-\_B (5 A to 100 A, 700 A to 1200 A), JFHR2.E56412 FWP-\_A (125 A to 600 A) and CSA Component Acceptance file class 1422-30, (53787) on 5 A to 800 A



#### Catalogue numbers

AC		DC		Rated current (Amps)	I <sup>2</sup> t (A <sup>2</sup> Sec)		Watts loss (W)	Catalogue numbers
Rated voltage	Breaking capacity	Rated voltage	Breaking capacity		Pre-arcing	Clearing at 700 V a.c.		
700 V a.c.	200 kA	500 V d.c. (10 ms)	50 kA	5	1.6	11	1.5	FWP-5B
700 V a.c.	200 kA	500 V d.c. (10 ms)	50 kA	10	3.6	22	4	FWP-10B
700 V a.c.	200 kA	500 V d.c. (10 ms)	50 kA	15	10	70	5.5	FWP-15B
700 V a.c.	200 kA	500 V d.c. (10 ms)	50 kA	20	26	180	6	FWP-20B
700 V a.c.	200 kA	500 V d.c. (10 ms)	50 kA	25	44	320	7	FWP-25B
700 V a.c.	200 kA	500 V d.c. (10 ms)	50 kA	30	58	450	9	FWP-30B
700 V a.c.	200 kA	700 V d.c.	50 kA	35	34	160	12	FWP-35D
700 V a.c.	200 kA	700 V d.c.	50 kA	40	76	320	12	FWP-40D
700 V a.c.	200 kA	700 V d.c.	50 kA	50	135	600	12	FWP-50D
700 V a.c.	200 kA	700 V d.c.	50 kA	60	210	950	15.5	FWP-60D
700 V a.c.	200 kA	700 V d.c.	50 kA	70	305	2000	18	FWP-70B
700 V a.c.	200 kA	700 V d.c.	50 kA	80	360	2400	21	FWP-80B
700 V a.c.	200 kA	700 V d.c.	50 kA	90	415	2700	25	FWP-90B
700 V a.c.	200 kA	700 V d.c.	50 kA	100	540	3500	27	FWP-100B
700 V a.c.	200 kA	700 V d.c.	10 kA	125	1800	7300	28	FWP-125A
700 V a.c.	200 kA	700 V d.c.	10 kA	150	2900	11,700	32	FWP-150A
700 V a.c.	200 kA	700 V d.c.	10 kA	175	4200	16,700	35	FWP-175A
700 V a.c.	200 kA	700 V d.c.	10 kA	200	5500	22,000	43	FWP-200A
700 V a.c.	200 kA	700 V d.c.	10 kA	225	7700	31,300	45	FWP-225A
700 V a.c.	200 kA	700 V d.c.	10 kA	250	10,500	42,500	48	FWP-250A
700 V a.c.	200 kA	700 V d.c.	10 kA	300	17,600	71,200	58	FWP-300A
700 V a.c.	200 kA	700 V d.c.	10 kA	350	23,700	95,600	65	FWP-350A
700 V a.c.	200 kA	700 V d.c.	10 kA	400	31,000	125,000	78	FWP-400A
700 V a.c.	200 kA	700 V d.c.	50 kA	450	36,400	137,000	94	FWP-450A
700 V a.c.	200 kA	700 V d.c.	50 kA	500	45,200	170,000	107	FWP-500A
700 V a.c.	200 kA	700 V d.c.	50 kA	600	66,700	250,000	122	FWP-600A
700 V a.c.	200 kA	700 V d.c.	50 kA	700	54,000	300,000	125	FWP-700A
700 V a.c.	200 kA	700 V d.c.	50 kA	800	78,000	450,000	140	FWP-800A
700 V a.c.	200 kA	N/A	N/A	900	91,500	530,000	150	FWP-900A
700 V a.c.	200 kA	N/A	N/A	1000	120,000	600,000	170	FWP-1000A
700 V a.c.	200 kA	N/A	N/A	1200	195,000	1,100,000	190	FWP-1200A

Data sheets: 720012, 5785316 (5-30 A), 361 (150-600 A), 5785308 (35-100 A, 700-1200 A)

# North American fuse links

## FWP - 700 V a.c. / V d.c.(UL), 5 A to 1200 A

Time-current curve - 5 A to 30 A

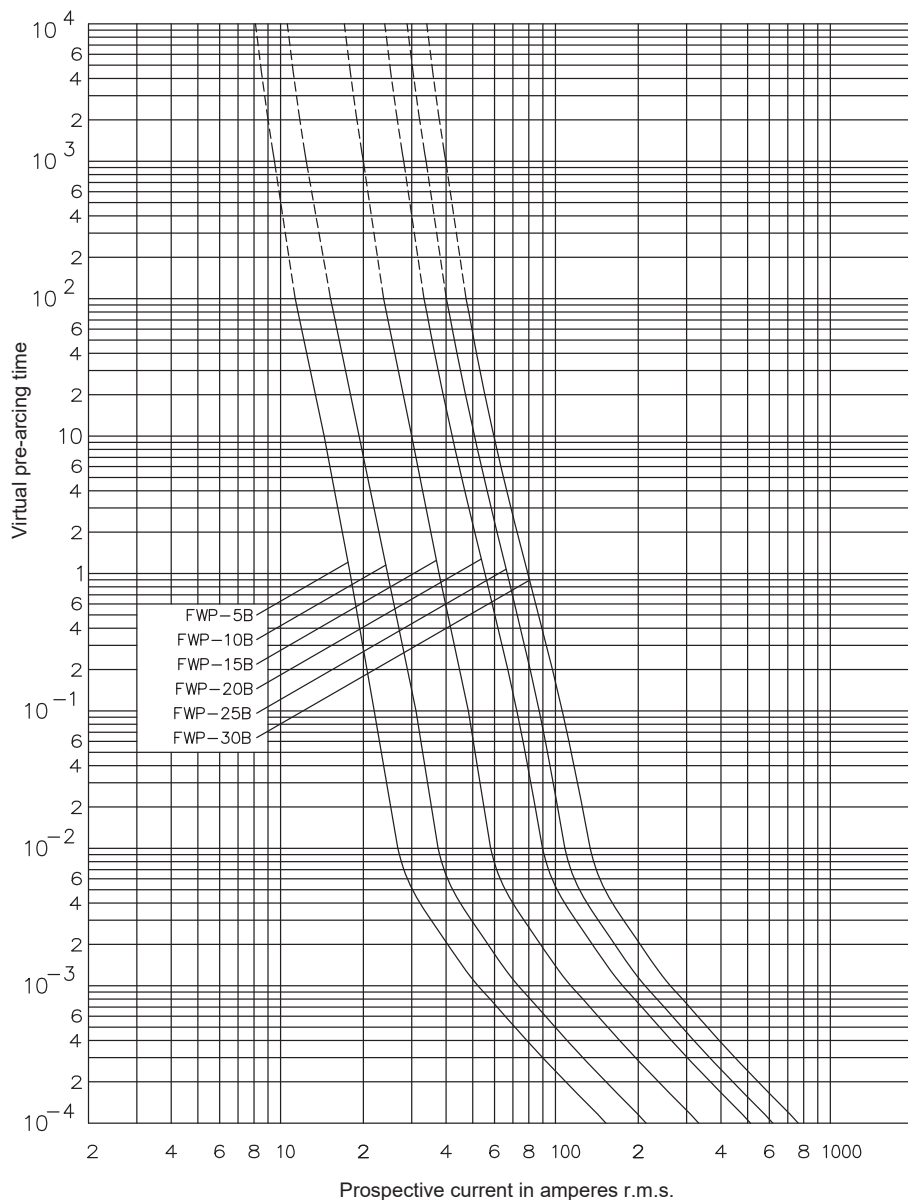

Data sheets: 720012, 5785316 (5-30 A), 361 (150-600 A), 5785308 (35-100 A, 700-1200 A)

**FWP - 700 V a.c. / V d.c.(UL), 5 A to 1200 A**

Time-current curve - 35 A to 1200 A

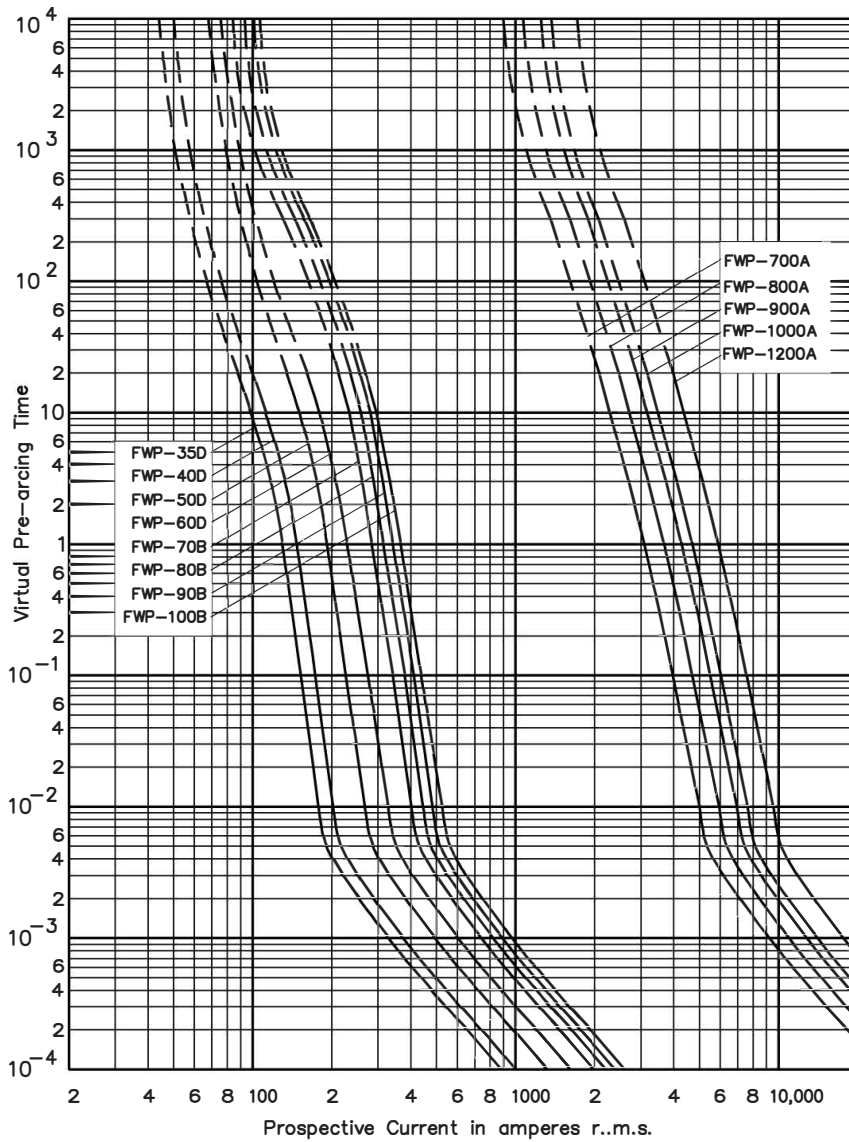

Contact [FUSETECH@eaton.com](mailto:FUSETECH@eaton.com) for the time current curves for the following ratings: 125 A to 600 A

Data sheets: 720012, 5785316 (5-30 A), 361 (150-600 A), 5785308 (35-100 A, 700-1200 A)

# North American fuse links

## FWP - 700 V a.c. / V d.c.(UL), 5 A to 1200 A

### Cut-off curve - 5 A to 1200 A

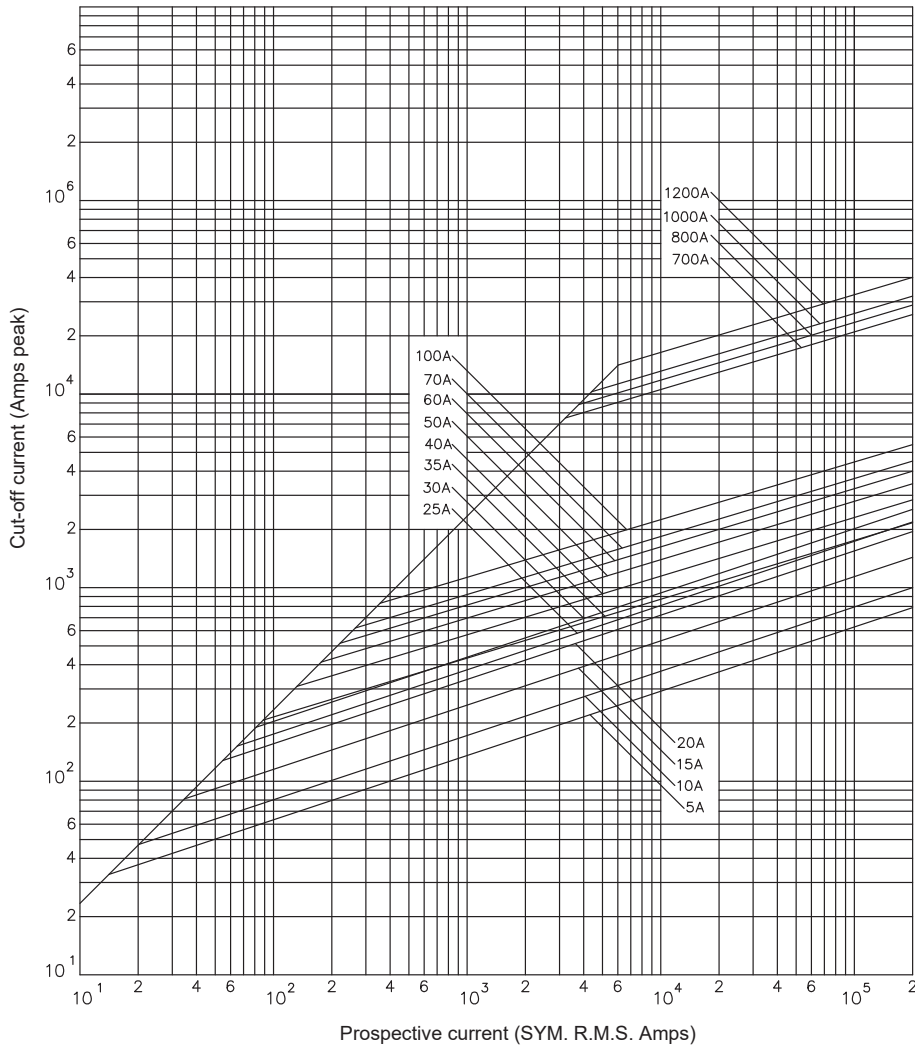

### Total clearing $I^2t$

The total clearing  $I^2t$  at rated voltage and at a power factor of 15 percent are given in the electrical characteristics. For other voltages, the clearing  $I^2t$  is found by multiplying by correction factor,  $K$ , given as a function of applied working voltage,  $E_g$ , (RMS).

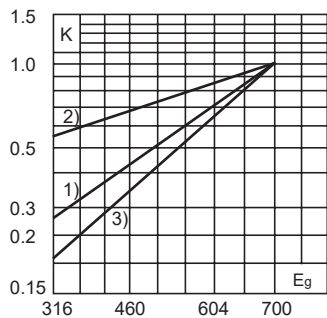

- 1) 35 - 100 A
- 2) 125 - 600 A
- 3) 700 to 1200 A

### Arc voltage

This curve gives the peak arc voltage,  $U_L$ , which may appear across the fuse during its operation as a function of the applied working voltage,  $E_g$ , (RMS) at a power factor of 15 percent.

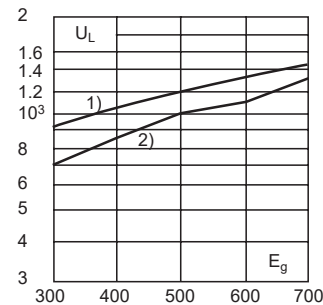

- 1) 125 - 600 A
- 2) 35 - 100 and 700 - 1200 A

### Watts losses

Watts loss at rated current is given in the electrical characteristics. The curve allows the calculation of the watts losses at load currents lower than the rated current. The correction factor,  $K_p$ , is given as a function of the RMS load current,  $I_b$ , in percent of the rated current.

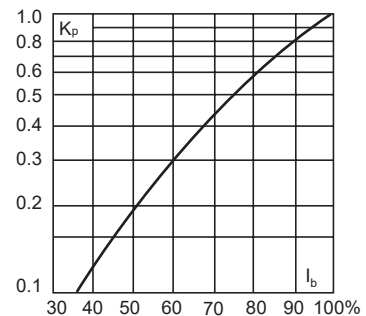

Data sheets: 720012, 5785316 (5-30 A), 361 (150-600 A), 5785308 (35-100 A, 700-1200 A)

**FWP - 700 V a.c. / V d.c.(UL), 5 A to 1200 A**

**Dimensions (in) - 5 A to 30 A**

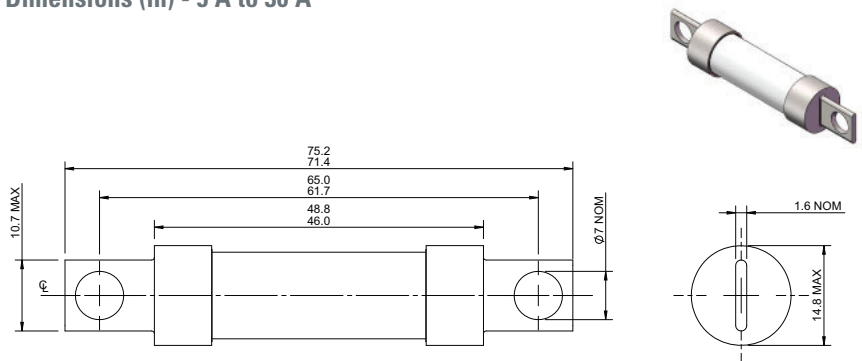

**Dimensions (in) - 35 A to 60 A**

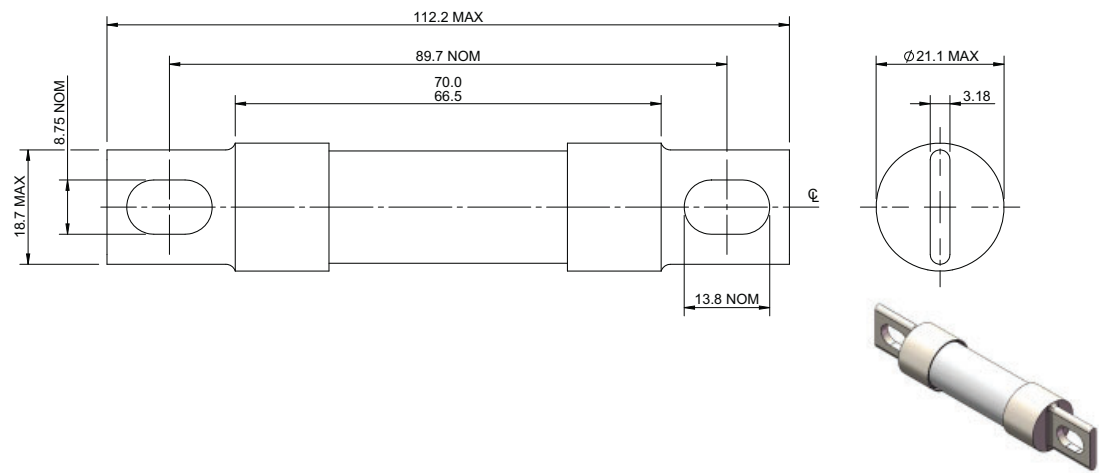

**Dimensions (in) - 70 A to 600 A**

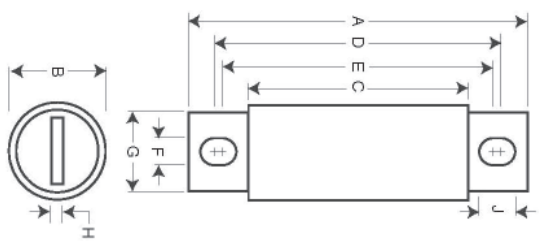

Amp range	A	B	C	D	E	F	G	H	J
70-100	4.41	0.95	2.59	3.63	3.56	0.34	0.75	0.13	0.38
125-200	5.09	1.5	2.84	4.19	3.5	0.41	1	0.25	0.75
225-400	5.09	2	2.84	4.28	3.53	0.41	1.5	0.25	0.78
450-600	7.09	2.5	2.84	5.72	4.19	0.53	2	0.38	1.3

1" = 25.4mm

# North American fuse links

## FWP - 700 V a.c. / V d.c.(UL), 5 A to 1200 A

### Dimensions (in) - 700 A and 800 A

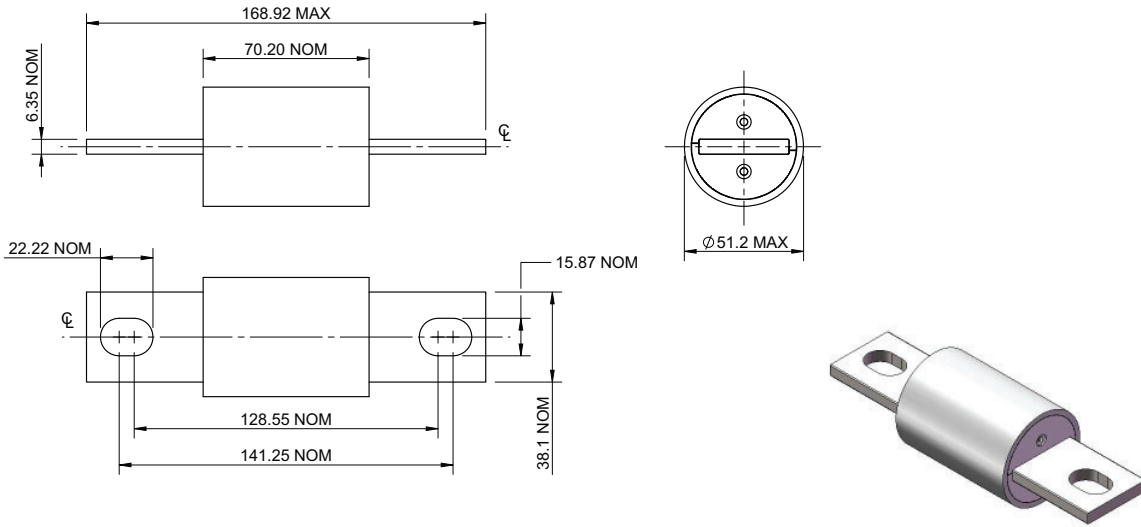

### Dimensions (in) - 900 A and 1000 A

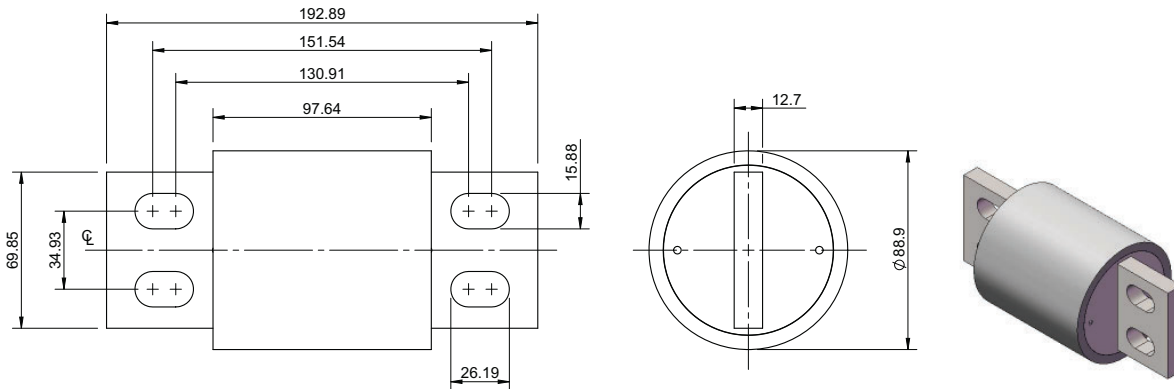

### Dimensions (mm) - 1200 A

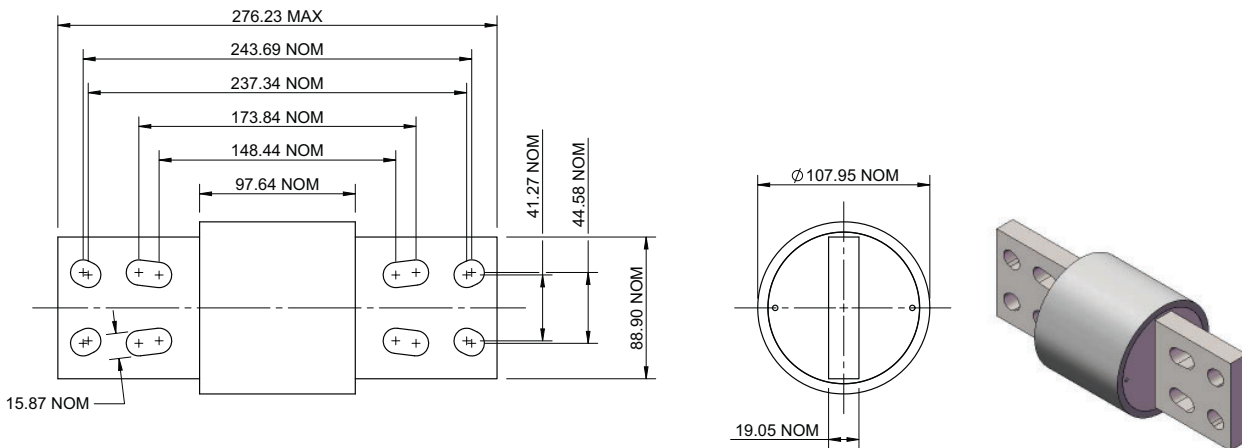

Data sheets: 720012, 5785316 (5-30 A), 361 (150-600 A), 5785308 (35-100 A, 700-1200 A)

## FWJ - 1000 V a.c. / 800 V d.c. (UL), 35 A to 2000 A

### Specifications

#### Description

North American style bolted tags high speed fuse links for the protection of DC common bus, DC drives power converters/rectifiers, reduced rated voltage starters.

#### Technical data

- Rated voltage:
  - 1000 V a.c. (UL)
  - 800 V d.c. (UL)
- Rated current: 35 A to 2000 A
- Breaking capacity:
  - 25kA RMS Sym. (35 A to 200 A)
  - 100 kA RMS Sym. (250 A to 2000 A)
  - 50 kA at 800 V d.c. (35 A to 200 A and 450 A to 600 A)

#### Standards / Agency information

CE, UL Recognition JFHR8.E91958 on 50 A to 600 A only

#### Catalogue numbers

AC		DC		Rated current (Amps)	I <sup>2</sup> t (A <sup>2</sup> Sec)		Watts loss (W)	Catalogue numbers
Rated voltage	Breaking capacity	Rated voltage	Breaking capacity		Pre-arcing	Clearing at 1000 V a.c.		
1000 V a.c.	25 kA	800 V d.c.	50 kA	35	210	2000	7	FWJ-35A
				40	300	2500	8	FWJ-40A
				50	470	3500	10	FWJ-50A
				60	670	5000	11	FWJ-60A
				70	1100	6900	12	FWJ-70A
				80	1550	9700	13	FWJ-80A
				90	1900	12,000	14	FWJ-90A
				100	2800	17,500	15	FWJ-100A
				125	4800	35,000	16	FWJ-125A
				150	6300	45,000	25	FWJ-150A
				175	7500	65,000	30	FWJ-175A
				200	11,700	80,000	32	FWJ-200A
				1000 V a.c.	100 kA	N/A	N/A	250
300	23,500	164,000	56					FWJ-300A
350	33,000	231,000	62					FWJ-350A
400	47,000	330,000	67					FWJ-400A
500	39,500	329,000	95					FWJ-500A
1000 V a.c.	100 kA	800 V d.c.	50 kA	600	61,000	520,000	105	FWJ-600A
				800	87,000	500,000	182	FWJ-800A
				1000	190,000	1,100,000	206	FWJ-1000A
				1200	370,000	2,100,000	240	FWJ-1200A
				1400	470,000	2,700,000	248	FWJ-1400A
				1600	700,000	4,000,000	267	FWJ-1600A
				1800	925,000	5,300,000	239	FWJ-1800A
				2000	1,330,000	7,600,000	244	FWJ-2000A

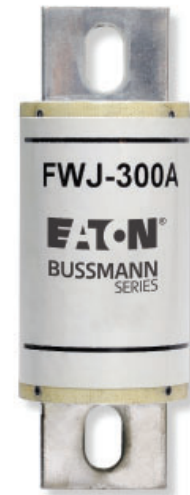

# North American fuse links

## FWJ - 1000 V a.c. / 800 V d.c. (UL), 35 A to 2000 A

### Dimensions (in) - 35 A to 2000 A

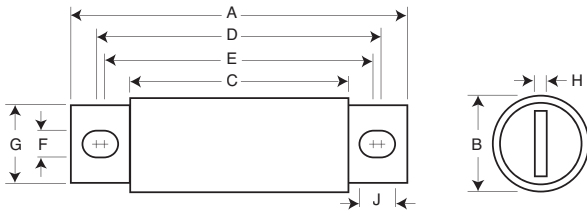

Amp range	A	B	C	D	E	F	G	H	J
35-60	5	0.94	3.11	4.24	4.18	0.35	0.75	0.13	0.38
70-100	4.93	1.13	3.09	4.27	4.16	0.35	1	0.19	0.41
125-200	5.69	1.53	3.26	4.80	4.06	0.45	1	0.25	0.82
250-400	5.77	2	3.5	4.81	4.15	0.43	1.5	0.25	0.76
500-600	7.20	2.5	3.47	5.98	4.71	0.56	2	0.38	1.2
800-2000	6.81	3.5	3.31	5.47	4.96	0.63	2.75	0.5	0.88

1" = 25.4mm

### Time-current curve - 35 A to 600 A

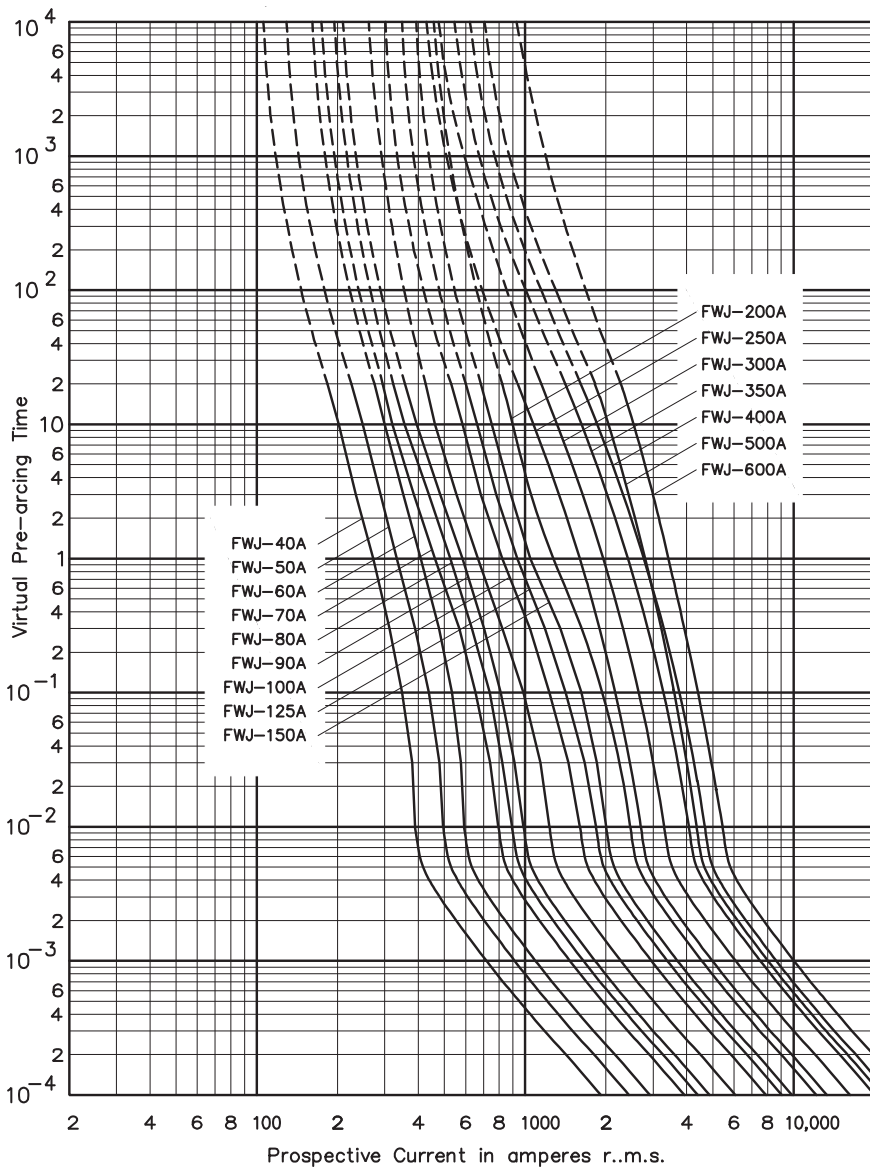

Data sheets: 720027, 5785303 (35-600 A), 5785309 (800-2000 A), E5785173



## FWJ - 1000 V a.c. / 800 V d.c. (UL), 35 A to 2000 A

Time-current curve - 800 A to 2000 A

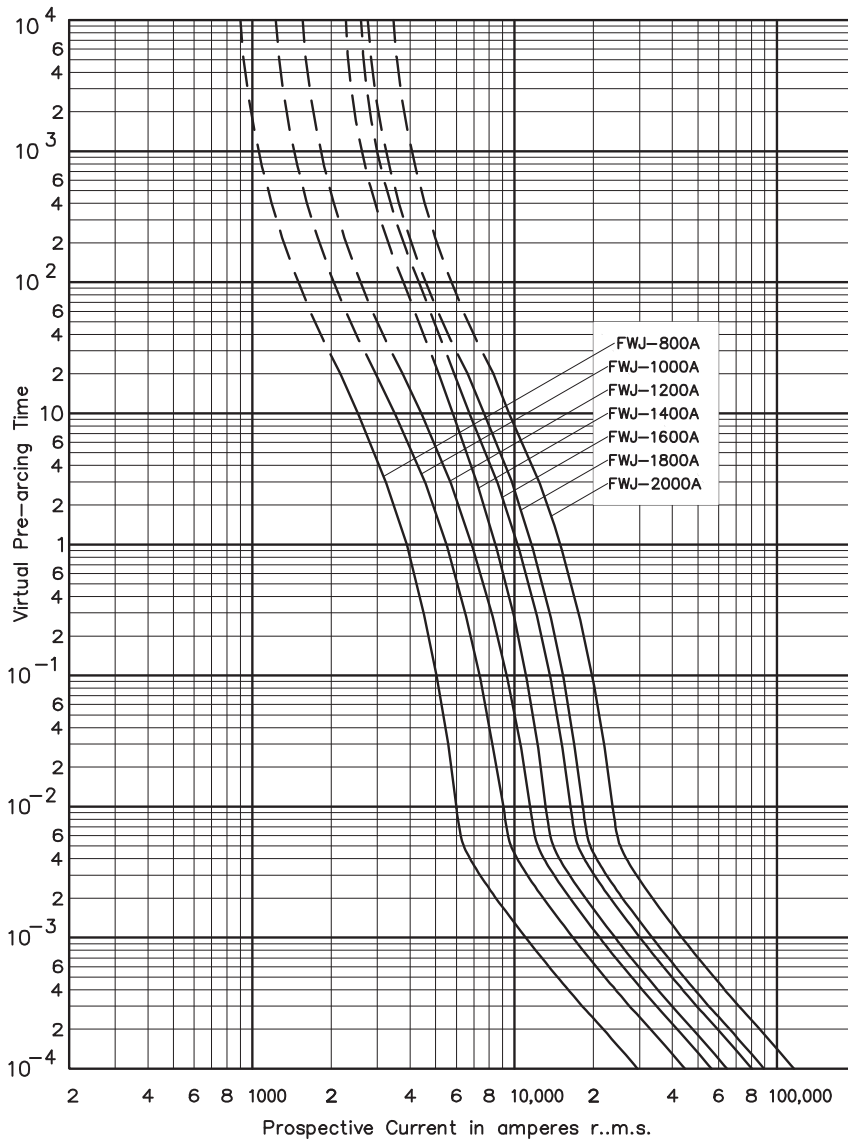

### Total clearing I<sup>2</sup>t

The total clearing I<sup>2</sup>t at rated voltage and at a power factor of 15 percent are given in the electrical characteristics. For other voltages, the clearing I<sup>2</sup>t is found by multiplying by correction factor, K, given as a function of applied working voltage, E<sub>g</sub>, (RMS).

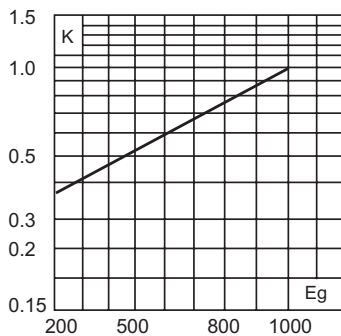

### Arc voltage

This curve gives the peak arc voltage, U<sub>L</sub>, which may appear across the fuse during its operation as a function of the applied working voltage, E<sub>g</sub>, (RMS) at a power factor of 15 percent.

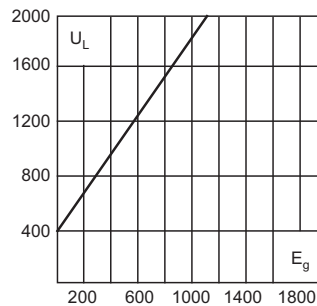

### Watts losses

Watts loss at rated current is given in the electrical characteristics. The curve allows the calculation of the watts losses at load currents lower than the rated current. The correction factor, K<sub>p</sub>, is given as a function of the RMS load current, I<sub>b</sub>, in percent of the rated current.

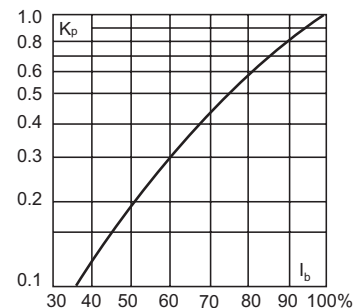

Data sheets: 720027, 5785303 (35-600 A), 5785309 (800-2000 A), E5785173

# North American fuse links

## FWE - 1000 V d.c. (IEC/UL), 70 A to 600 A

### Specifications

#### Description

North American style bolted tags high speed fuse links designed for the protection of DC charging stations, specialist vehicle onboard applications and general DC power conversion equipment and battery systems voltage starters.

#### Technical data

- Rated voltage: 1000 V d.c. (IEC/UL)
- Rated current: 70 A to 600 A
- Breaking capacity: 100 kA
- Operating class: aR



#### Standards / Agency information

CE, IEC 60269-4 and UL 248-13 Recognised

#### Catalogue numbers

Rated voltage	Rated current	Watts loss (50% rated current)	Watts loss (100% rated current)	Pre-arcing I <sup>2</sup> t (A <sup>2</sup> Sec)	Clearing I <sup>2</sup> t	Breaking capacity	Operating class	Catalogue number
1000 V d.c. (IEC/UL)	70	3.8	21	680	3500	100 kA	aR	FWE-70A
	80	4.2	24	1020	5000	100 kA	aR	FWE-80A
	90	4.6	27	1400	6500	100 kA	aR	FWE-90A
	100	5	30	1820	8500	100 kA	aR	FWE-100A
	125	6	43	1830	7800	100 kA	aR	FWE-125A
	150	7	49	2670	12000	100 kA	aR	FWE-150A
	175	8	52	4670	20700	100 kA	aR	FWE-175A
	200	9	56	6900	29300	100 kA	aR	FWE-200A
	225	10	69	7880	31600	100 kA	aR	FWE-225A
	250	11	79	9940	39900	100 kA	aR	FWE-250A
	275	12	83	13000	52100	100 kA	aR	FWE-275A
	300	13	87	16800	67500	100 kA	aR	FWE-300A
	350	15	100	21100	89300	100 kA	aR	FWE-350A
	400	16	110	31500	125500	100 kA	aR	FWE-400A
	450	19	139	35300	166200	100 kA	aR	FWE-450A
	500	21	155	49300	203900	100 kA	aR	FWE-500A
550	23	167	58600	322600	100 kA	aR	FWE-550A	
600	25	180	74700	346500	100 kA	aR	FWE-600A	

#### Dimensions (cm)

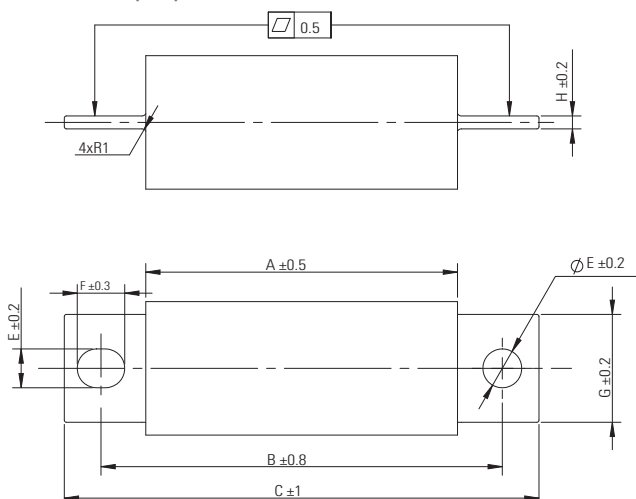

Catalogue number	A	B	C	D	E	F	G	H
70A to 100A	72.2	93	110	25.4	9	11	19	2.2
125A to 200A	72.2	93	110	31	9	11	25	3
225A to 300A	72.2	100	122	38.1	11	13	28	3.5
350A to 400A	72.2	100	122	50.8	11	13	28	5
450A to 600A	72.2	100	122	63.5	11	13	40	6

**FWE - 1000 V V d.c. (IEC/UL), 70 A to 600 A**

**Time-current curve - 70 A to 100 A**

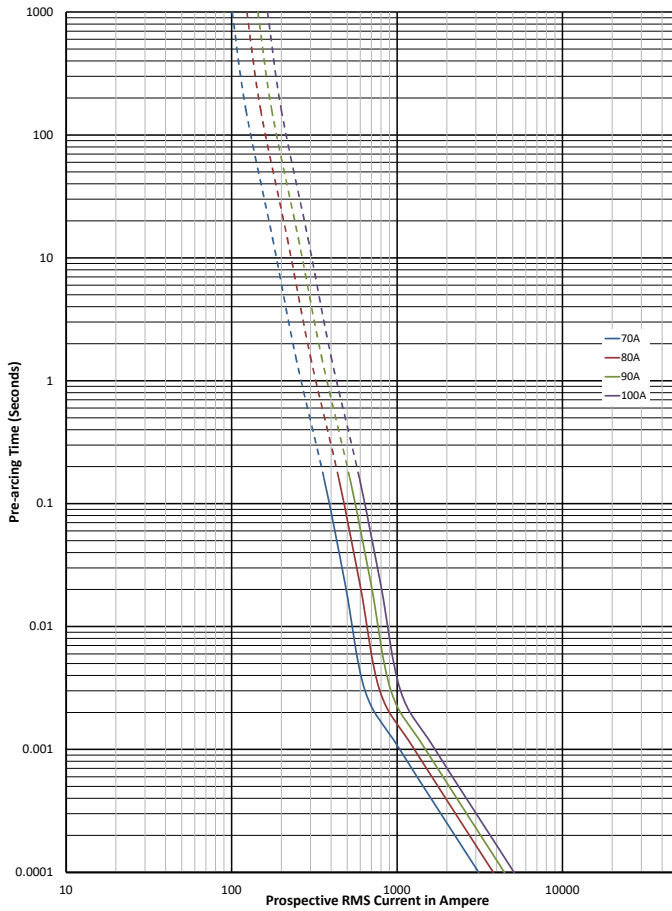

$K_b = 1 \quad N = 1.7$

**Total clearing  $I^2t$**

The total clearing  $I^2t$  at rated voltage and tested DC time constant are given in electrical characteristics. For other voltages the clearing  $I^2t$  is found by multiplying by correction factor, K, given as a function of applied working voltages,  $E_g$ .

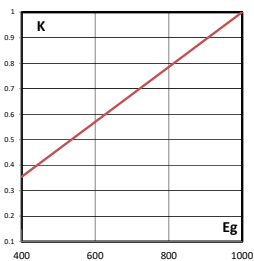

**Arc voltage**

This curve gives the peak arc voltage,  $U_L$ , which may appear across the fuse during its operation as a function of the applied working voltage,  $E_g$ , at a time constant of 10ms.

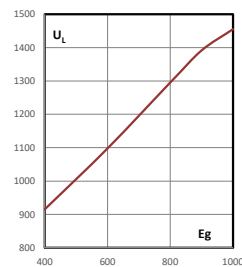

**Watts losses**

Watts loss at rated current is given in the electrical characteristics. The curve allows the calculation of the watts losses at load currents lower than the rated current. The correction factor,  $K_p$ , is given as a function of the RMS load current,  $I_b$ , in percent of the rated current.

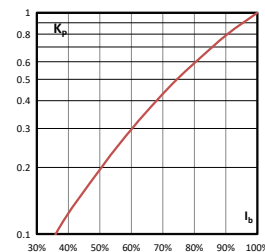

# North American fuse links

## FWE - 1000 V V d.c. (IEC/UL), 70 A to 600 A

### Time-current curve - 125 A to 200 A

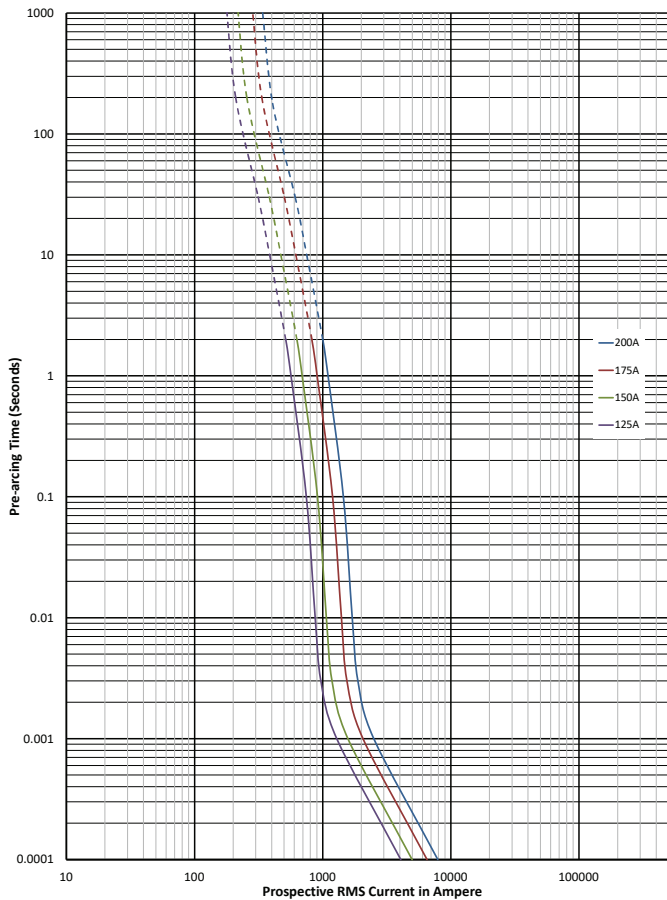

$K_b = 1$   $N = 1.7$

### Total clearing $I^2t$

The total clearing  $I^2t$  at rated voltage and tested DC time constant are given in electrical characteristics. For other voltages the clearing  $I^2t$  is found by multiplying by correction factor,  $K$ , given as a function of applied working voltages,  $E_g$ .

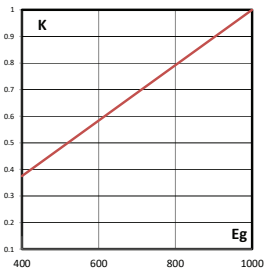

### Arc voltage

This curve gives the peak arc voltage,  $U_L$ , which may appear across the fuse during its operation as a function of the applied working voltage,  $E_g$ , at a time constant of 10ms.

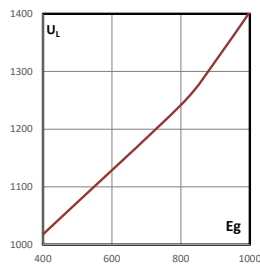

### Watts losses

Watts loss at rated current is given in the electrical characteristics. The curve allows the calculation of the watts losses at load currents lower than the rated current. The correction factor,  $K_p$ , is given as a function of the RMS load current,  $I_b$ , in percent of the rated current.

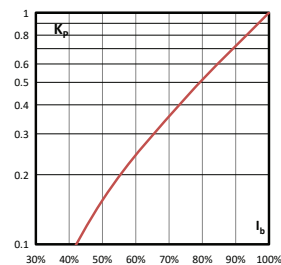

**FWE - 1000 V V d.c. (IEC/UL), 70 A to 600 A**

**Time-current curve - 225 A to 300 A**

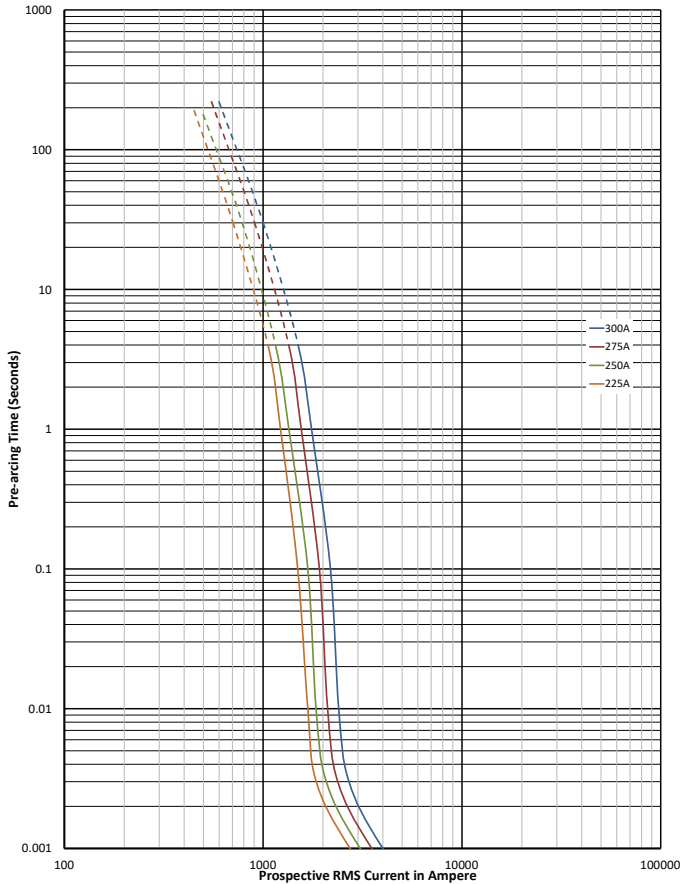

$K_b = 1 \quad N = 1.7$

**Total clearing  $I^2t$**

The total clearing  $I^2t$  at rated voltage and tested DC time constant are given in electrical characteristics. For other voltages the clearing  $I^2t$  is found by multiplying by correction factor,  $K$ , given as a function of applied working voltages,  $E_g$ .

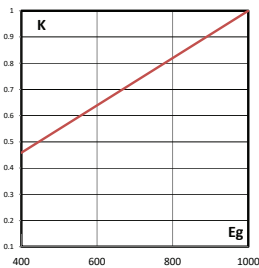

**Arc voltage**

This curve gives the peak arc voltage,  $U_L$ , which may appear across the fuse during its operation as a function of the applied working voltage,  $E_g$ , at a time constant of 10ms.

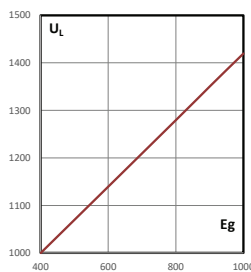

**Watts losses**

Watts loss at rated current is given in the electrical characteristics. The curve allows the calculation of the watts losses at load currents lower than the rated current. The correction factor,  $K_p$ , is given as a function of the RMS load current,  $I_b$ , in percent of the rated current.

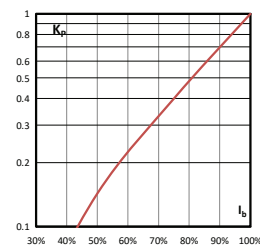

# North American fuse links

## FWE - 1000 V V d.c. (IEC/UL), 70 A to 600 A

### Time-current curve - 350 A and 400 A

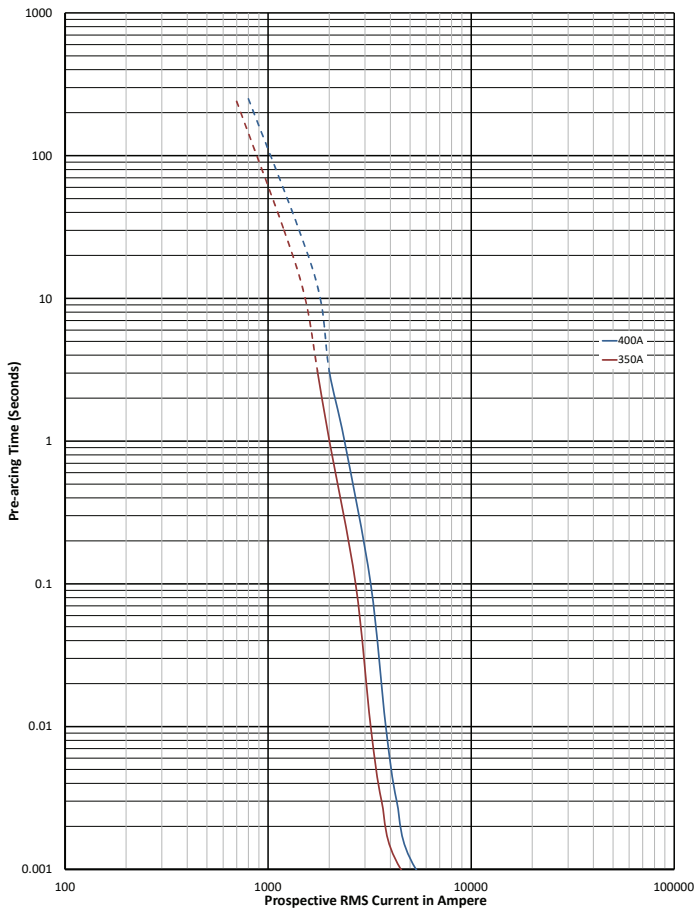

$K_b = 1$   $N = 1.7$

### Total clearing $I^2t$

The total clearing  $I^2t$  at rated voltage and tested DC time constant are given in electrical characteristics. For other voltages the clearing  $I^2t$  is found by multiplying by correction factor,  $K$ , given as a function of applied working voltages,  $E_g$ .

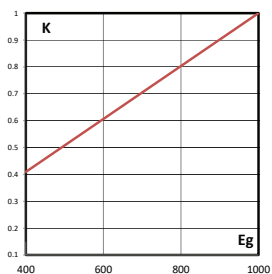

### Arc voltage

This curve gives the peak arc voltage,  $U_L$ , which may appear across the fuse during its operation as a function of the applied working voltage,  $E_g$ , at a time constant of 10ms.

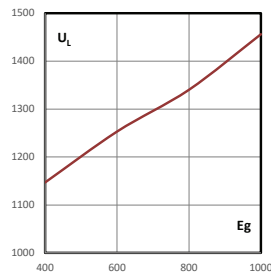

### Watts losses

Watts loss at rated current is given in the electrical characteristics. The curve allows the calculation of the watts losses at load currents lower than the rated current. The correction factor,  $K_p$ , is given as a function of the RMS load current,  $I_b$ , in percent of the rated current.

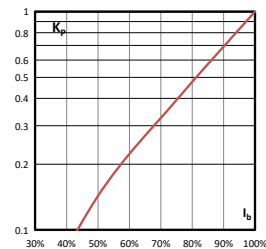

**FWE - 1000 V V d.c. (IEC/UL), 70 A to 600 A**

**Time-current curve - 450 A to 600 A**

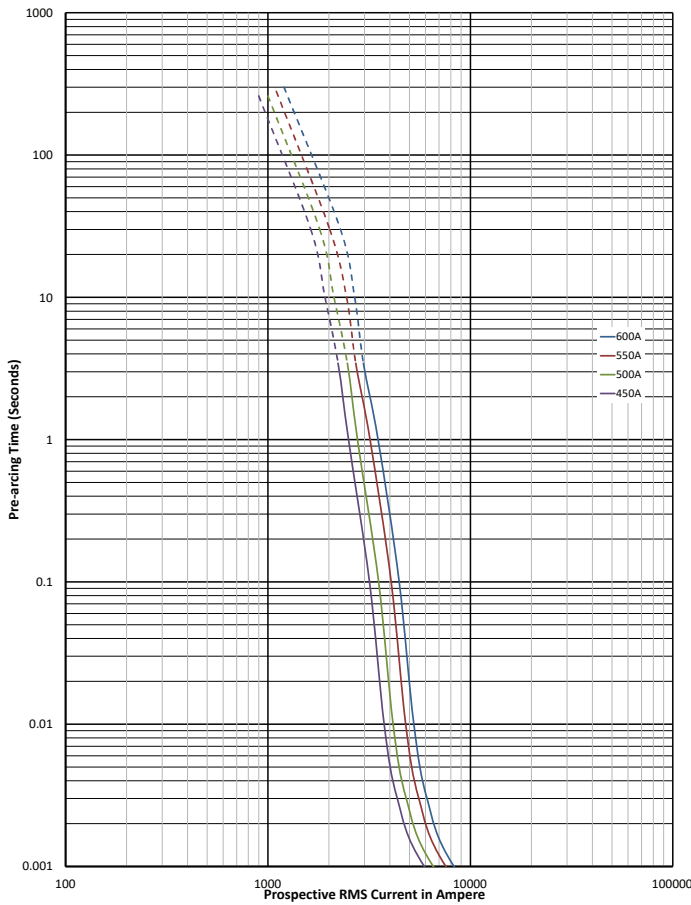

$K_b = 1$   $N = 1.7$

**Total clearing  $I^2t$**

The total clearing  $I^2t$  at rated voltage and tested DC time constant are given in electrical characteristics. For other voltages the clearing  $I^2t$  is found by multiplying by correction factor, K, given as a function of applied working voltages,  $E_g$ .

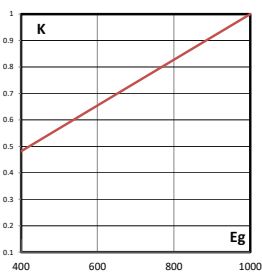

**Arc voltage**

This curve gives the peak arc voltage,  $U_L$ , which may appear across the fuse during its operation as a function of the applied working voltage,  $E_g$ , at a time constant of 10ms.

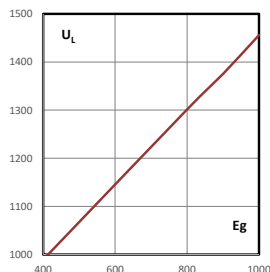

**Watts losses**

Watts loss at rated current is given in the electrical characteristics. The curve allows the calculation of the watts losses at load currents lower than the rated current. The correction factor,  $K_p$ , is given as a function of the RMS load current,  $I_b$ , in percent of the rated current.

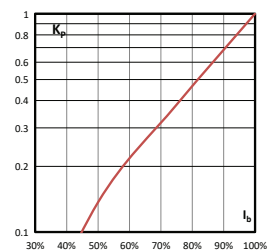

# British standard BS88 fuse links

## LCT, LET - 240 V a.c. / 150 V d.c. (IEC), 250-280 V a.c. / 150 V d.c. (UL), 6 A to 180 A

### Specifications

#### Description

BS88 style bolted tags fuse high speed links for the protection of DC common bus, DC drives, power converters/rectifiers and reduced rated voltage starters. Low Watts loss in a compact size.

#### Technical Data

- Rated voltage:
  - LCT 240 V a.c. / 150 V d.c. (IEC)  
250 V a.c. / 150 V d.c. (UL)
  - LET 280 V a.c. / 150 V d.c. (UL, 25 A to 160 A)  
250 V a.c. / 150 V d.c. (UL 180 A)
- Rated current: 6 A to 180 A
- Breaking capacity:
  - 200 kA RMS Sym.
  - 50 kA DC at 150 V d.c.
- Operating Class: aR



#### Compatible trip indicator and microswitch for LET fuse links

- See details page 395

#### Standards / Agency information

CE, designed and tested to BS88 part 4, IEC 60269 Part 4, UL Recognised and CCC (LCT only). All fuse links have been tested at 318V a.c..Consult Eaton for specific UL recognition status.

#### Catalogue numbers

Fuse link type	Rated voltage	Rated current (Amps)	I <sup>2</sup> t (A <sup>2</sup> Sec)		Watts loss (W)	Catalogue numbers
			Pre-arcing	Clearing at 240 V a.c.		
LCT	240 V a.c. / 150 V d.c. (IEC)	6	2	9	1	6LCT
		10	3.8	22	2.5	10LCT
		12	7	32	2.5	12LCT
	250 V a.c. / 150 V d.c. (UL)	16	20	100	2.5	16LCT
		20	25	160	4	20LCT
		25	18	250	4	25LET
LET	280 V a.c. / 150 V d.c. (UL)	32	32	450	5	32LET
		35	50	600	5	35LET
		50	100	1400	7	50LET
		63	180	2200	9	63LET
		80	300	3800	10	80LET
		100	600	7500	10	100LET
		125	600	7500	16	125LET
		160	1100	16,000	20	160LET
250 V a.c. / 150 V d.c. (UL)	180	1600	29,000	21	180LET	

Note: 7LET, 10LET, 12LET and 16LET are available for replacement purposes on existing equipment.

Data sheets: 720004, 5785296 (LCT), 5785293 (LET)



**LCT, LET - 240 V a.c. / 150 V d.c. (IEC), 250-280 V a.c. / 150 V d.c. (UL), 6 A to 180 A**

**Dimensions (mm) - LCT**

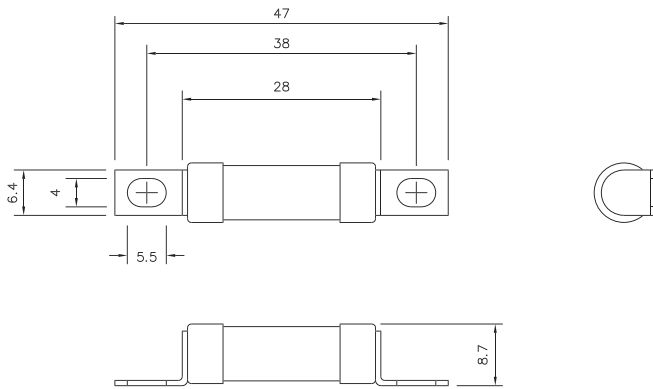

**Dimensions (mm) - LET, up to 63 A**

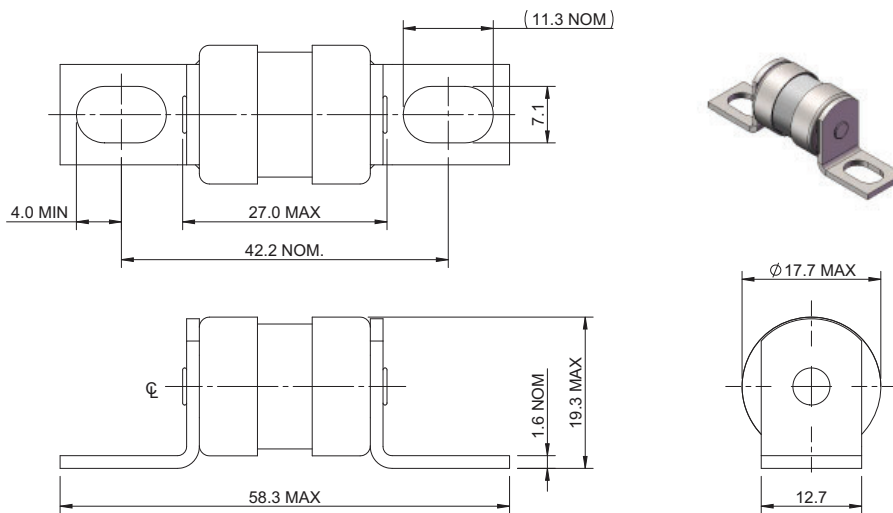

**Dimensions (mm) - LET, greater than 63 A**

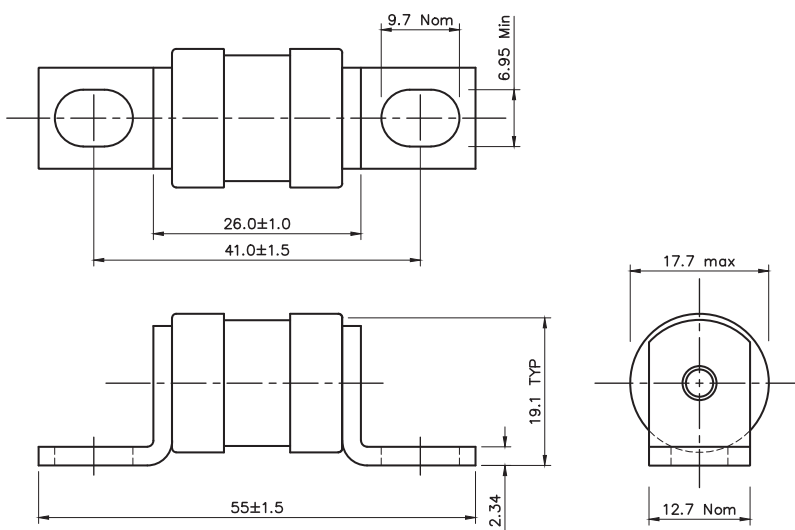

Indicator (optional).

Data sheets: 720004, 5785296 (LCT), 5785293 (LET)

# British standard BS88 fuse links

**LCT, LET** - 240 V a.c. / 150 V d.c. (IEC), 250-280 V a.c. / 150 V d.c. (UL), 6 A to 180 A

Time-current curve - LCT, 6 A to 20 A

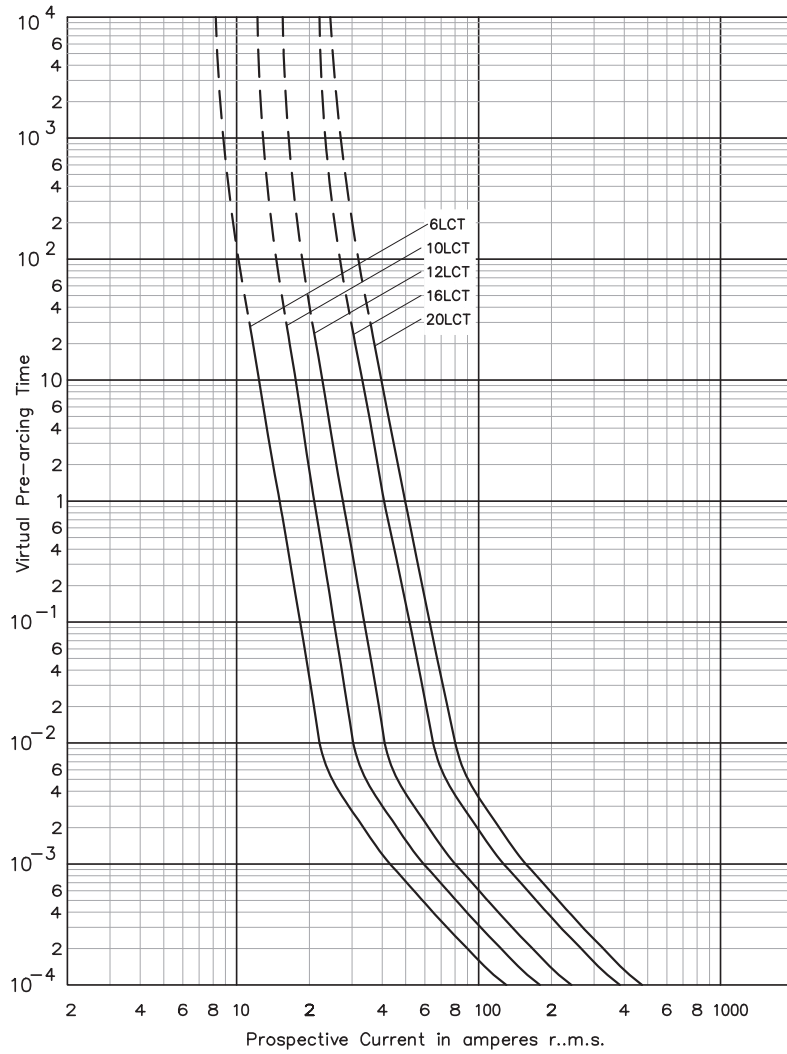

Data sheets: 720004, 5785296 (LCT), 5785293 (LET)

**LCT, LET - 240 V a.c. / 150 V d.c. (IEC), 250-280 V a.c. / 150 V d.c. (UL), 6 A to 180 A**

**Time-current curve - LET, 25 A to 180 A**

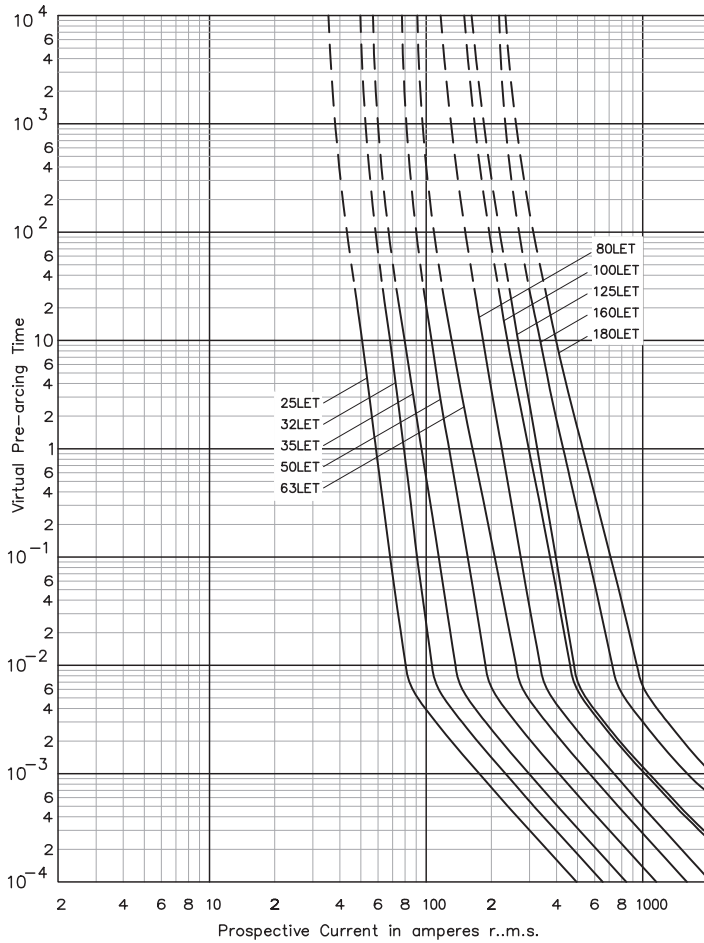

**Total clearing I<sup>2</sup>t**

The total clearing I<sup>2</sup>t at rated voltage and at a power factor of 15 percent are given in the electrical characteristics. For other voltages, the clearing I<sup>2</sup>t is found by multiplying by correction factor, K, given as a function of applied working voltage, E<sub>g</sub>, (RMS).

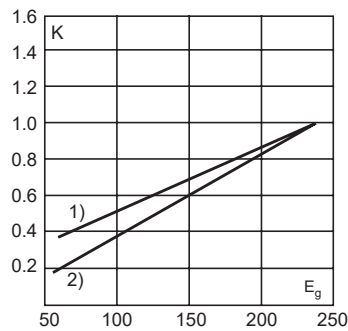

- 1) LCT
- 2) LET

**Arc voltage**

This curve gives the peak arc voltage, U<sub>L</sub>, which may appear across the fuse during its operation as a function of the applied working voltage, E<sub>g</sub>, (RMS) at a power factor of 15 percent.

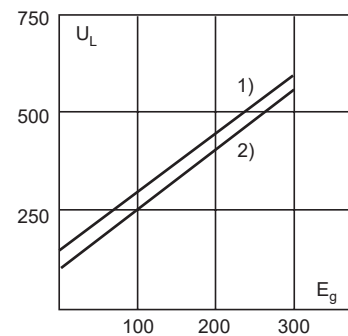

- 1) LCT
- 2) LET

**Watts losses**

Watts loss at rated current is given in the electrical characteristics. The curve allows the calculation of the watts losses at load currents lower than the rated current. The correction factor, K<sub>p</sub>, is given as a function of the RMS load current, I<sub>b</sub>, in percent of the rated current.

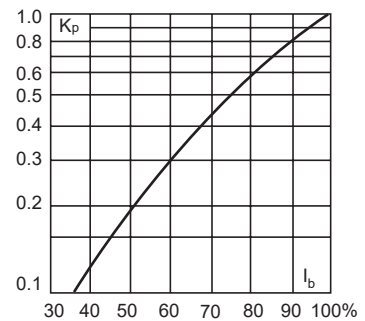

Data sheets: 720004, 5785296 (LCT), 5785293 (LET)

# British standard BS88 fuse links

## LMT, LMMT - 240 V a.c. / 150 V d.c. (IEC), 250 V a.c. / 150 V d.c. (UL), 160 A to 900 A

### Specifications

#### Description

BS88 style bolted tags high speed fuse links for the protection of DC common bus, DC drives, power converters/rectifiers and reduced rate voltage starters. Low watts loss in a compact size.

#### Technical Data

- Rated voltage:
  - 240 V a.c. / 150 V d.c. (IEC)
  - 250 V a.c. / 150 V d.c. (UL)
- Rated current: 160 A to 900 A
- Breaking capacity:
  - 200 kA RMS Sym., 40 kA at 150 V d.c. (IEC)
  - 200 kA RMS Sym., 50 kA at 150 V d.c. (UL)
- Operating Class: aR



#### Compatible trip indicator and microswitch

- See details page 395

#### Standards / Agency information

CE, designed and tested to BS88 part 4, IEC 60269 Part 4, UL recognised and CCC. All fuse links have been tested at 318V a.c. Consult Eaton for specific UL recognition status.

#### Catalogue numbers

Fuse link type	Rated voltage	Rated current (Amps)	I <sup>2</sup> t (A <sup>2</sup> Sec)			Watts loss (W)	Catalogue numbers
			Pre-arcing	Clearing at 120 V a.c.	Clearing at 240 V a.c.		
LMT Single barrel	240 V a.c. / 150 V d.c. (IEC) 250 V a.c. / 150 V d.c. (UL)	160	1100	7000	16,000	17	160LMT
		200	1500	10,000	20,000	28	200LMT
		250	3200	20,000	40,000	28	250LMT
		315	6000	35,000	75,000	35	315LMT
		355	8000	50,000	100,000	35	355LMT
		400	14,000	70,000	160,000	40	400LMT
LMMT Double barrel	240 V a.c. / 150 V d.c. (IEC) 250 V a.c. / 150 V d.c. (UL)	450	18,000	100,000	220,000	42	450LMT
		400	6000	35,000	80,000	60	400LMMT
		500	14,000	80,000	170,000	64	500LMMT
		630	24,000	150,000	300,000	75	630LMMT
		710	32,000	200,000	460,000	77	710LMMT
		800	52,000	300,000	600,000	82	800LMMT
	900	75,000	400,000	800,000	97	900LMMT	

#### Dimensions (mm) - LMT (indicator optional)

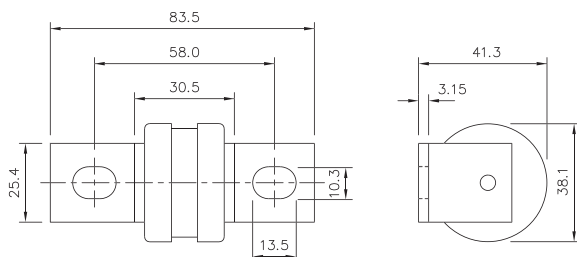

Data sheets: 720004, 5785294 (LMT), 5785295 (LMMT)

**LMT, LMMT - 240 V a.c. / 150 V d.c. (IEC), 250 V a.c. / 150 V d.c. (UL), 160 A to 900 A**

**Dimensions (mm) - LMMT (indicator optional)**

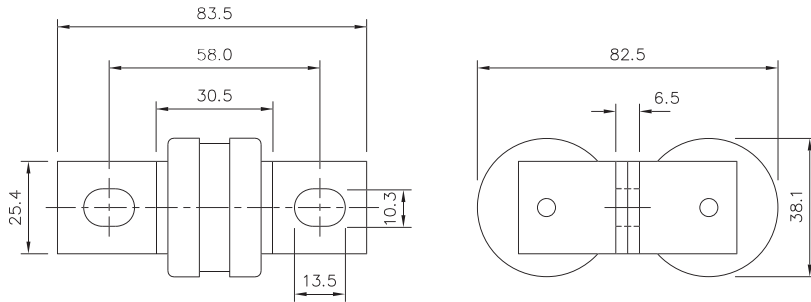

**Time-current curve - LMT, 160 A to 450 A**

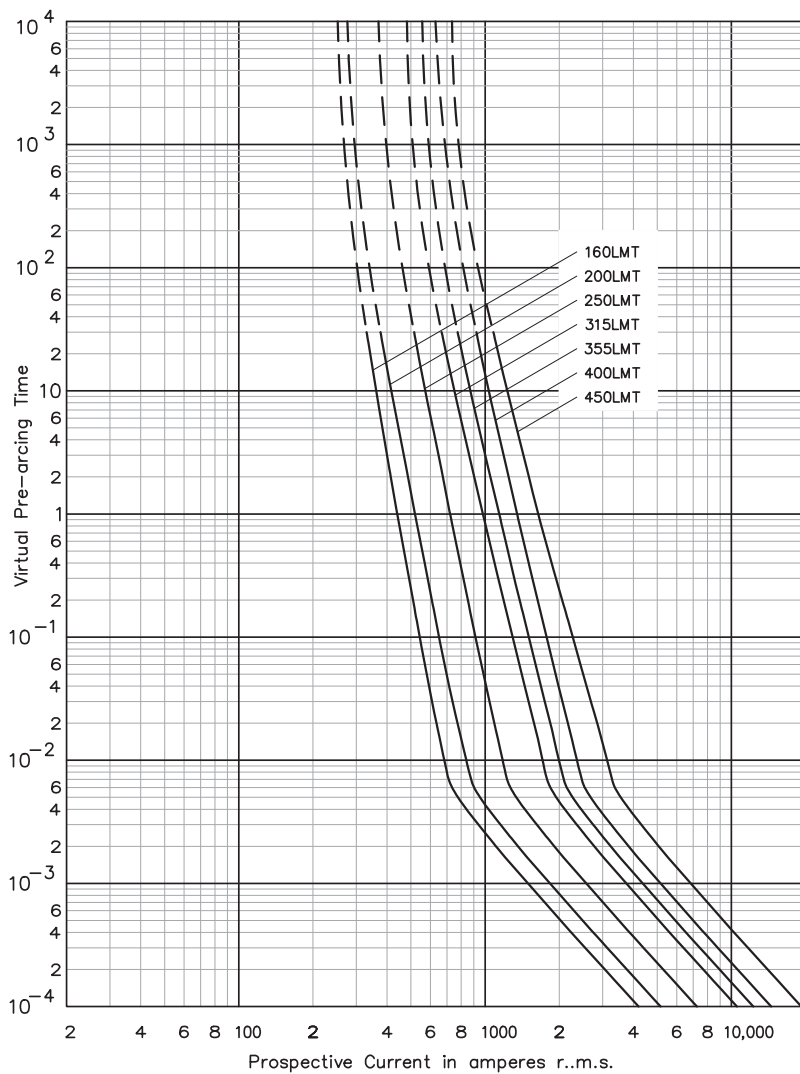

Data sheets: 720004, 5785294 (LMT), 5785295 (LMMT)

# British standard BS88 fuse links

## LMT, LMMT - 240 V a.c. / 150 V d.c. (IEC), 250 V a.c. / 150 V d.c. (UL), 160 A to 900 A

### Time-current curve - LMMT, 400 A to 900 A

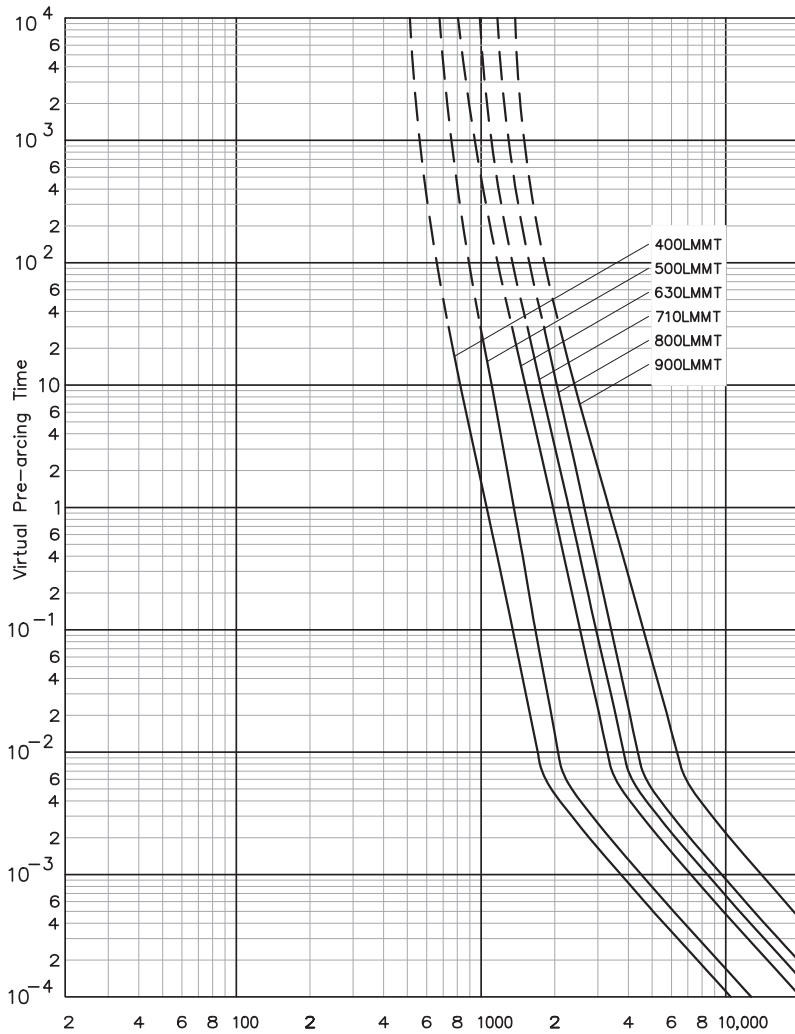

### Total clearing $I^2t$

The total clearing  $I^2t$  at rated voltage and at a power factor of 15 percent are given in the electrical characteristics. For other voltages, the clearing  $I^2t$  is found by multiplying by correction factor,  $K$ , given as a function of applied working voltage,  $E_g$ , (RMS).

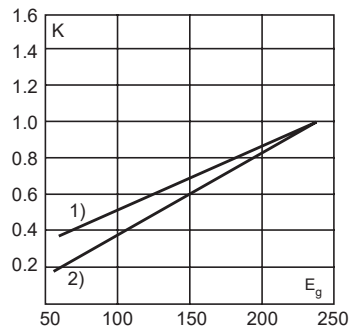

2) LMT, LMMT

### Arc voltage

This curve gives the peak arc voltage,  $U_L$ , which may appear across the fuse during its operation as a function of the applied working voltage,  $E_g$ , (RMS) at a power factor of 15 percent.

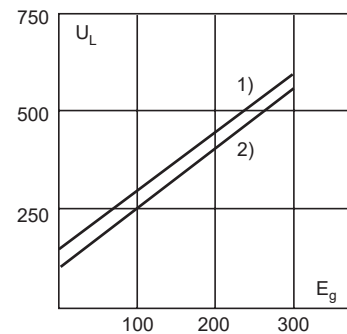

2) LMT, LMMT

### Watts losses

Watts loss at rated current is given in the electrical characteristics. The curve allows the calculation of the watts losses at load currents lower than the rated current. The correction factor,  $K_p$ , is given as a function of the RMS load current,  $I_b$ , in percent of the rated current.

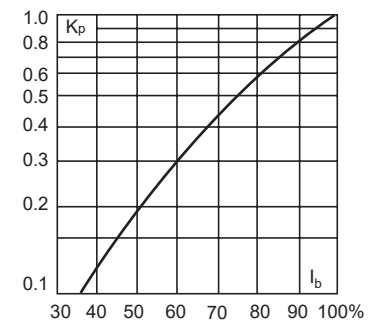

**CT, ET, FE, EET, FEE - 690 V a.c. / 500 V d.c. (IEC), 700 V a.c. / 500 V d.c. (UL), 6 A to 200 A**

**Specifications**

**Description**

BS88 style bolted tags high speed fuse links for the protection of DC common bus, DC drives, power converters / rectifiers and reduced rated voltage starters.

**Technical data**

- Rated voltage:
  - 690 V a.c. / 500 V d.c. (IEC)
  - 700 V a.c. / 500 V d.c. (UL)
- Rated current: 6 A to 200 A
- Breaking capacity:
  - CT: 90 kA RMS Sym., 40 kA at 500 V d.c. (IEC)
  - 200 kA RMS Sym., 50 kA at 500 V d.c. (UL)
  - ET, EET, FE and FEE: 200 kA RMS Sym., 50 kA at 500 V d.c.
- Operating Class: aR.

**Compatible trip indicator and microswitch**

- See details page 395

**Standards / Agency information**

CE, designed and tested to BS88 part 4, IEC 60269 Part 4, Consult Eaton for specific UL Recognition status. CCC for ET, FE, EET, FEE.



**Dimensions (mm) - CT**

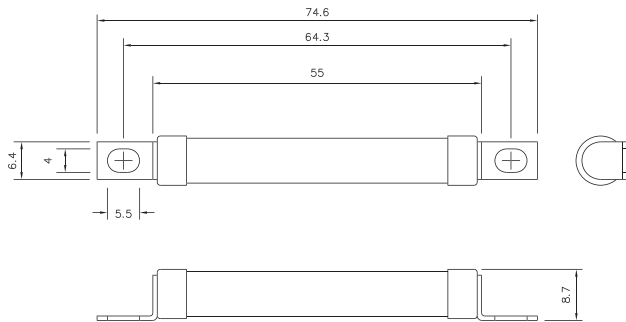

**Dimensions (mm) - ET, FE up to 63 A**

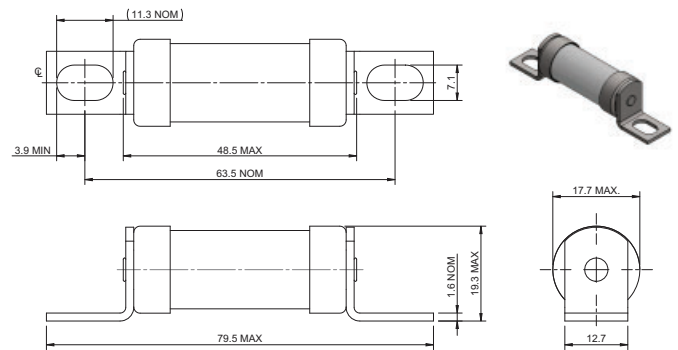

**Dimensions (mm) - ET, FE greater than 63 A**

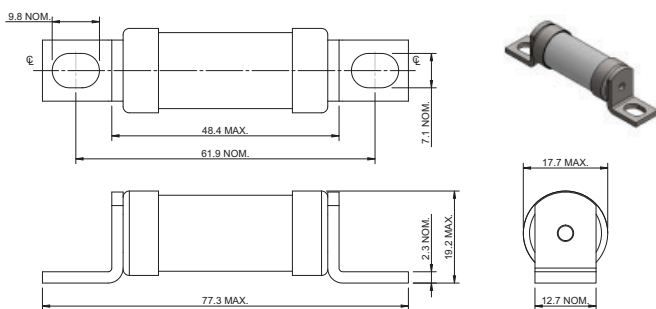

**Dimensions (mm) - EET and FEE**

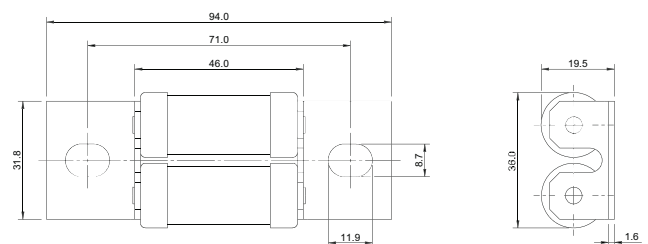

Data sheets: 720024, 5785312 (CT, ET), 5785314 (FE), 5785313 (EET), 5785292 (FEE)

# British standard BS88 fuse links

## CT, ET, FE, EET, FEE - 690 V a.c./500 V d.c. (IEC), 700 V a.c./500 V d.c. (UL), 6 A to 200 A

### Catalogue numbers

Fuse link type	Rated voltage	Rated current (Amps)	I <sup>2</sup> t (A <sup>2</sup> Sec)			Watts loss (W)	Catalogue numbers		
			Pre-arcing	Clearing at 415V a.c.	Clearing at 660 V a.c.				
CT	690 V a.c. / 500 V d.c. (IEC)	6	1.8	8.5	12	2	6CT		
		10	7	30	48	3	10CT		
		12	10	40	65	3	12CT		
		700 V a.c. / 500 V d.c. (UL)	16	16	66	110	7	16CT	
			20	32	150	220	7	20CT	
ET	690 V a.c. / 500 V d.c. (IEC)	25	25	150	250	7	25ET		
		32	32	190	350	11	32ET		
		35	52	310	500	11	35ET		
		40	103	600	900	9	40ET		
		45	103	680	1100	11	45ET		
	700 V a.c. / 500 V d.c. (UL)	56	135	950	1500	14	56ET		
		63	171	1200	2000	16	63ET		
		80	360	2500	4000	18	80ET		
		FE	690 V a.c. / 500 V d.c. (IEC)	35	33	130	200	9	35FE
				40	52	180	300	9	40FE
45	76			270	450	11	45FE		
50	103			380	600	11	50FE		
63	135			480	750	12	63FE		
700 V a.c. / 500 V d.c. (UL)	71	210	600	950	17	71FE			
	80	250	900	1500	20	80FE			
	90	360	1300	2100	20	90FE			
	100	470	1800	2800	23	100FE			
	EET	690 V a.c. / 500 V d.c. (IEC)	90	490	3000	4500	19	90EET	
			110	600	4000	6500	27	110EET	
			140	1050	7000	12,000	35	140EET	
700 V a.c. / 700 V d.c. (UL)	160	1500	10,000	17,000	39	160EET			
	FEE	690 V a.c. / 500 V d.c. (IEC)	100	400	1600	2400	24	100FEE	
			120	540	1900	3100	32	120FEE	
140			850	2500	3800	36	140FEE		
160			1000	3700	5700	46	160FEE		
180			1400	5300	8400	46	180FEE		
700 V a.c. / 500 V d.c. (UL)	200	1900	7100	11,400	52	200FEE			

Note: FC, 8ET, 12ET, 15ET, 20ET, 65EET and 75EET are available for replacement purposes on existings equipment.



**CT, ET, FE, EET, FEE -690 V a.c. / 500 V d.c. (IEC), 700 V a.c. / 500 V d.c. (UL), 6 A to 200 A**

**Time-current curve - CT, 6 A to 20 A and ET 25 A to 80 A**

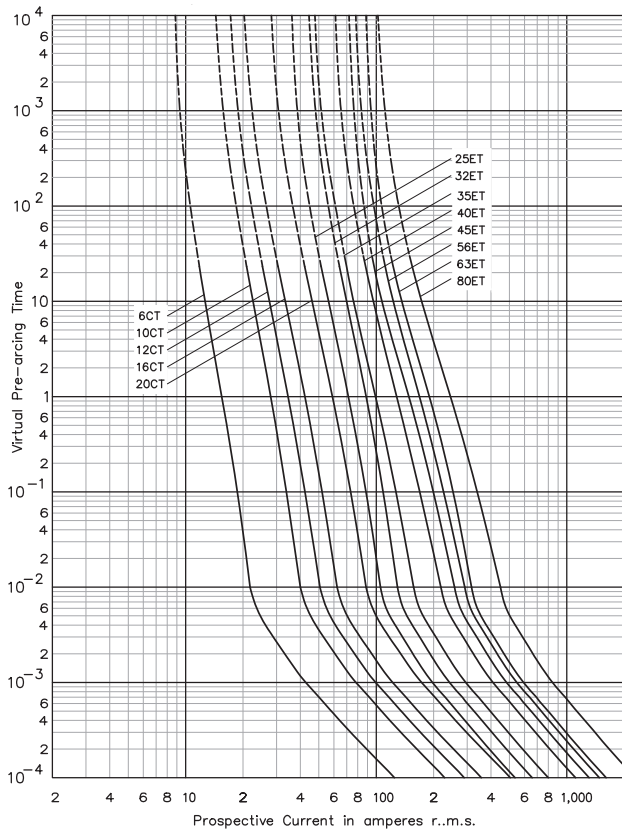

**Time-current curve - FE, 35 A to 100 A**

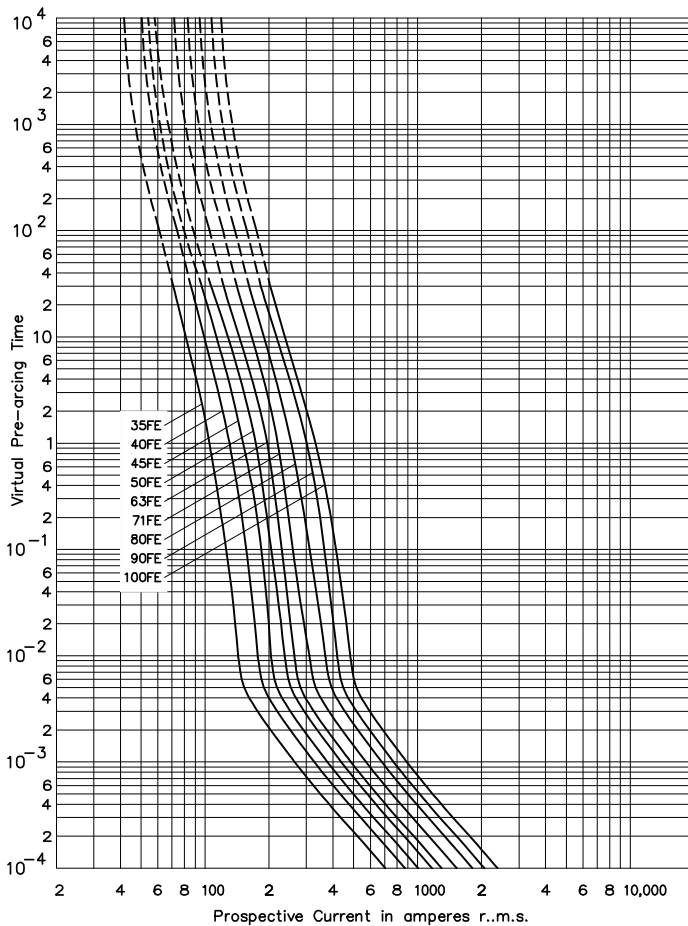

Data sheets: 720024, 5785312 (CT, ET), 5785314 (FE), 5785313 (EET), 5785292 (FEE)

# British standard BS88 fuse links

**CT, ET, FE, EET, FEE** - 690 V a.c. / 500 V d.c. (IEC), 700 V a.c. / 500 V d.c. (UL), 6 A to 200 A

Time-current curve - EET, 90 A to 160 A

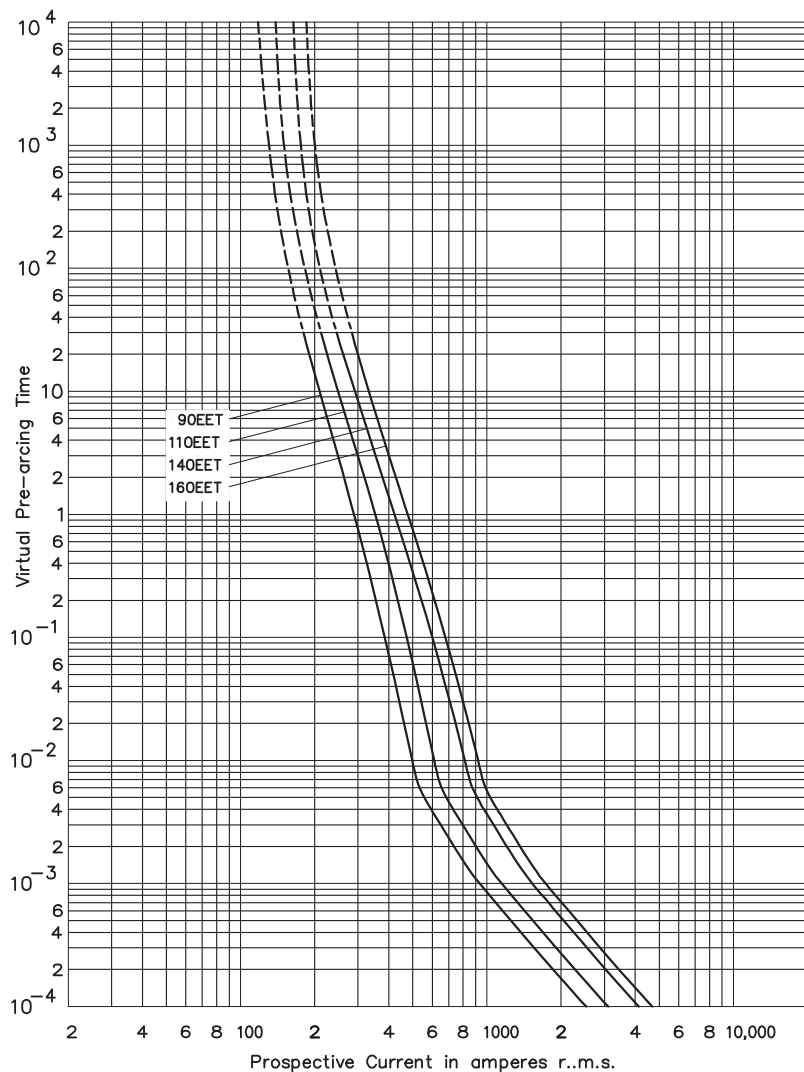

**CT, ET, FE, EET, FEE - 690 V a.c./500 V d.c. (IEC), 700 V a.c./500 V d.c. (UL), 6 A to 200 A**

**Time-current curve - FEE, 100 A to 200 A**

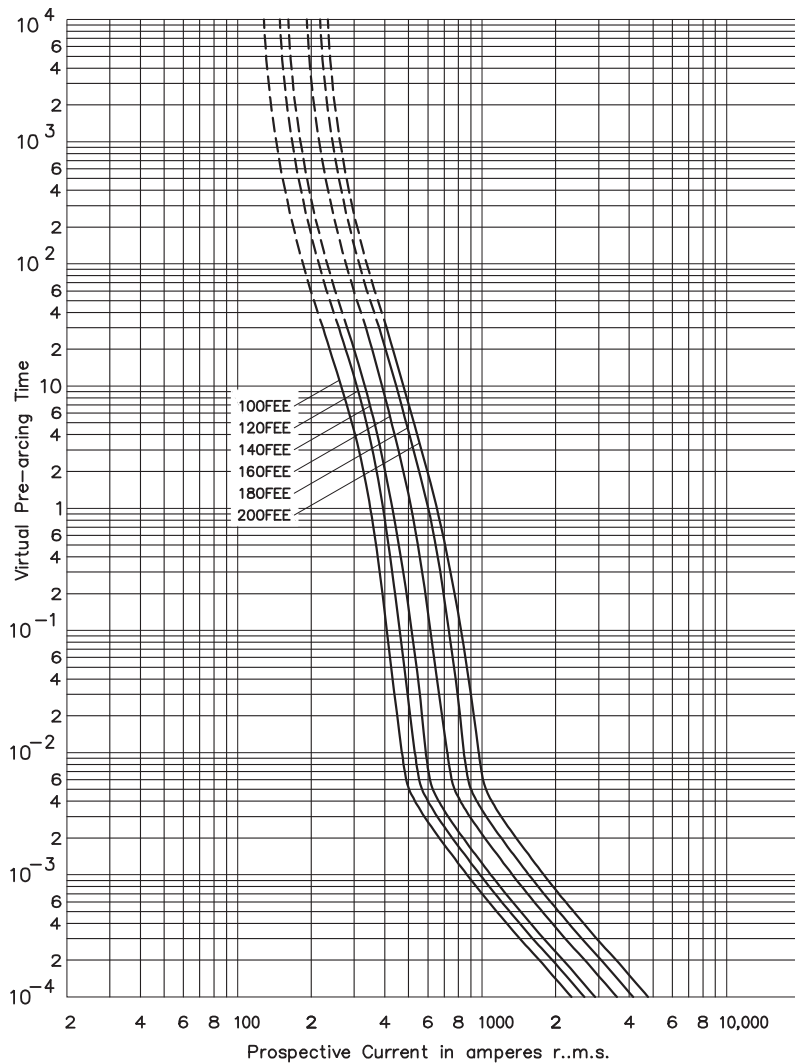

**Total clearing I<sup>2</sup>t**

The total clearing I<sup>2</sup>t at rated voltage and at a power factor of 15 percent are given in the electrical characteristics. For other voltages, the clearing I<sup>2</sup>t is found by multiplying by correction factor, K, given as a function of applied working voltage, E<sub>g</sub>, (RMS).

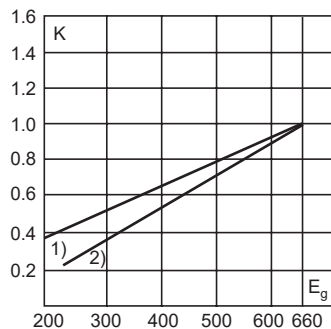

1) CT, ET, FE, FEE

**Arc voltage**

This curve gives the peak arc voltage, U<sub>L</sub>, which may appear across the fuse during its operation as a function of the applied working voltage, E<sub>g</sub>, (RMS) at a power factor of 15 percent.

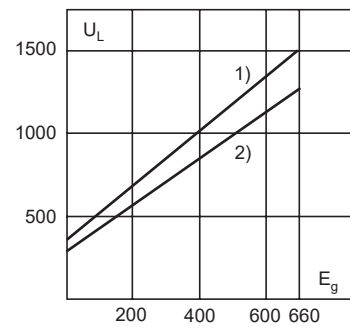

1) CT, ET, FE, FEE

**Watts losses**

Watts loss at rated current is given in the electrical characteristics. The curve allows the calculation of the watts losses at load currents lower than the rated current. The correction factor, K<sub>p</sub>, is given as a function of the RMS load current, I<sub>b</sub>, in percent of the rated current.

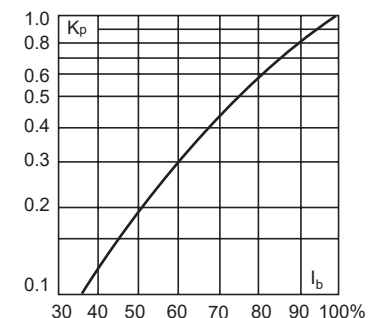

Data sheets: 720024, 5785312 (CT, ET), 5785314 (FE), 5785313 (EET), 5785292 (FEE)

# British standard BS88 fuse links

**FM, FMM, MT, MMT** - 690 V a.c. / 350-450 V d.c. (IEC), 700 V a.c. / 500 V d.c. (UL), 160 A to 710 A

## Specifications

### Description

BS88 style bolted tags high speed fuse links for the protection of DC common bus, DC drives, power converters / rectifiers and reduced rated voltage starters.

### Technical data

- Rated voltage:
  - FM: 690 V a.c. / 450 V d.c. (IEC); 700 V a.c./500 V d.c. (UL)
  - FMM: 690 V a.c. / 450 V d.c. (IEC)
  - MT and MMT: 690 V a.c. / 350 V d.c. (IEC); 700 V a.c. (UL)
- Rated current: 160 A to 710 A
- Breaking capacity:
  - FM: 200 kA RMS Sym. (IEC/UL), 40 kA at 450 V d.c. (IEC), 50 kA at 500 V d.c. (UL)
  - FMM: 200 kA RMS Sym. (IEC/UL), 40 kA at 450 V d.c. (IEC)
  - MT & MMT: 200 kA RMS Sym. (IEC/UL), 40 kA at 350 V d.c. (IEC)
- Operating Class: aR



### Compatible trip indicator and microswitch

- See details page 395

### Standards / Agency information

CE, designed and tested to BS88 part 4, IEC 60269 Part 4, UL Recognised. MT and MMT 350 V d.c. (IEC) rating. Consult Eaton for specific UL Recognition status. CCC for FM and FMM.

### Dimensions (mm) - FM and MT (indicator optional)

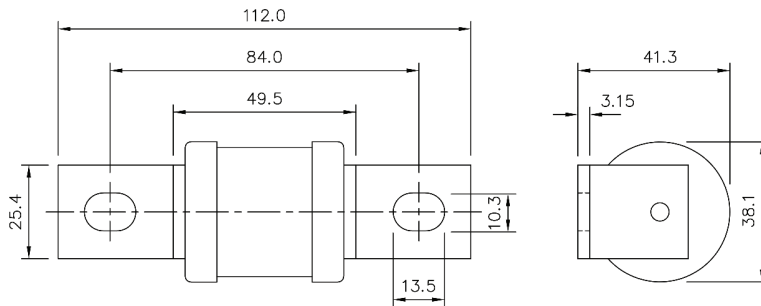

### Dimensions (mm) - FMM and MMT (indicator optional)

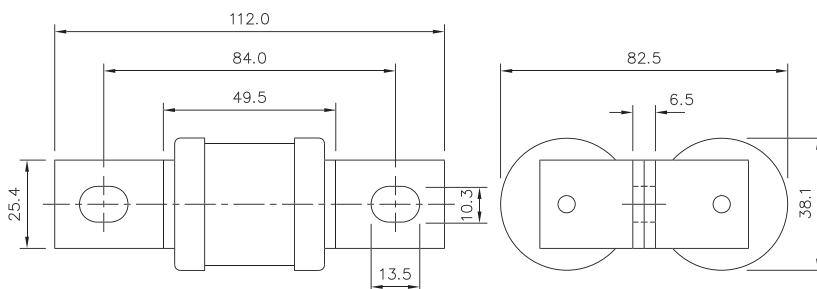

Data sheets: 720024, 5785314 (FM), 5785313 (MT), 5785292 (FMM), 5785311 (MMT)

**FM, FMM, MT, MMT - 690 V a.c. / 350-450 V d.c. (IEC), 700 V a.c. / 500 V d.c. (UL), 160 A to 710 A**

## Catalogue numbers

Fuse link type	Rated voltage	Rated current (Amps)	I <sup>2</sup> t (A <sup>2</sup> Sec)		Watts loss (W)	Catalogue numbers	
			Pre-arcing	Clearing at 415V a.c.			
FM	690 V a.c. / 450 V d.c. (IEC) 700 V a.c. / 500 V d.c. (UL)	180	1400	7500	13,500	40	180FM
		200	2600	10,500	18,500	40	200FM
		225	3700	14,500	26,500	44	225FM
		250	5200	20,500	37,500	48	250FM
		280	7000	30,500	55,000	48	280FM
		315	10,000	40,000	77,000	55	315FM
		350	15,000	60,000	105,000	55	350FM
FMM	690 V a.c. / 450 V d.c. (IEC)	400	10,000	40,000	72,500	85	400FMM
		450	15,000	60,000	105,000	90	450FMM
		500	20,000	82,000	150,000	100	500FMM
		550	30,000	120,000	215,000	100	550FMM
		630	45,000	180,000	310,000	100	630FMM
		700	60,000	245,000	420,000	120	700FMM
MT	690 V a.c. / 350 V d.c. (IEC) 700 V a.c. (UL)	160	2400	15,000	25,000	26	160MT
		180	3800	25,000	38,000	26	180MT
		200	6000	40,000	58,000	27	200MT
		250	11,500	80,000	110,000	32	250MT
		280	16,500	100,000	150,000	35	280MT
		315	19,000	125,000	180,000	42	315MT
		355	22,000	160,000	200,000	51	355MT
MMT	690 V a.c. / 350 V d.c. (IEC) 700 V a.c. (UL)	180	1650	12,000	18,000	42	180MMT
		200	2200	16,000	23,000	42	200MMT
		225	3700	26,000	40,000	42	225MMT
		280	6600	47,000	70,000	47	280MMT
		315	8600	62,000	91,000	51	315MMT
		355	13,500	97,000	140,000	54	355MMT
		400	21,000	150,000	220,000	60	400MMT
		450	30,000	220,000	320,000	57	450MMT
		500	42,000	300,000	450,000	64	500MMT
		560	60,000	430,000	640,000	64	560MMT
		630	68,500	500,000	720,000	86	630MMT
710	78,000	600,000	850,000	105	710MMT		

# British standard BS88 fuse links

**FM, FMM, MT, MMT** - 690 V a.c. / 350-450 V d.c. (IEC), 700 V a.c. / 500 V d.c. (UL), 160 A to 710 A

Time-current curve - FM, 180 A to 350 A

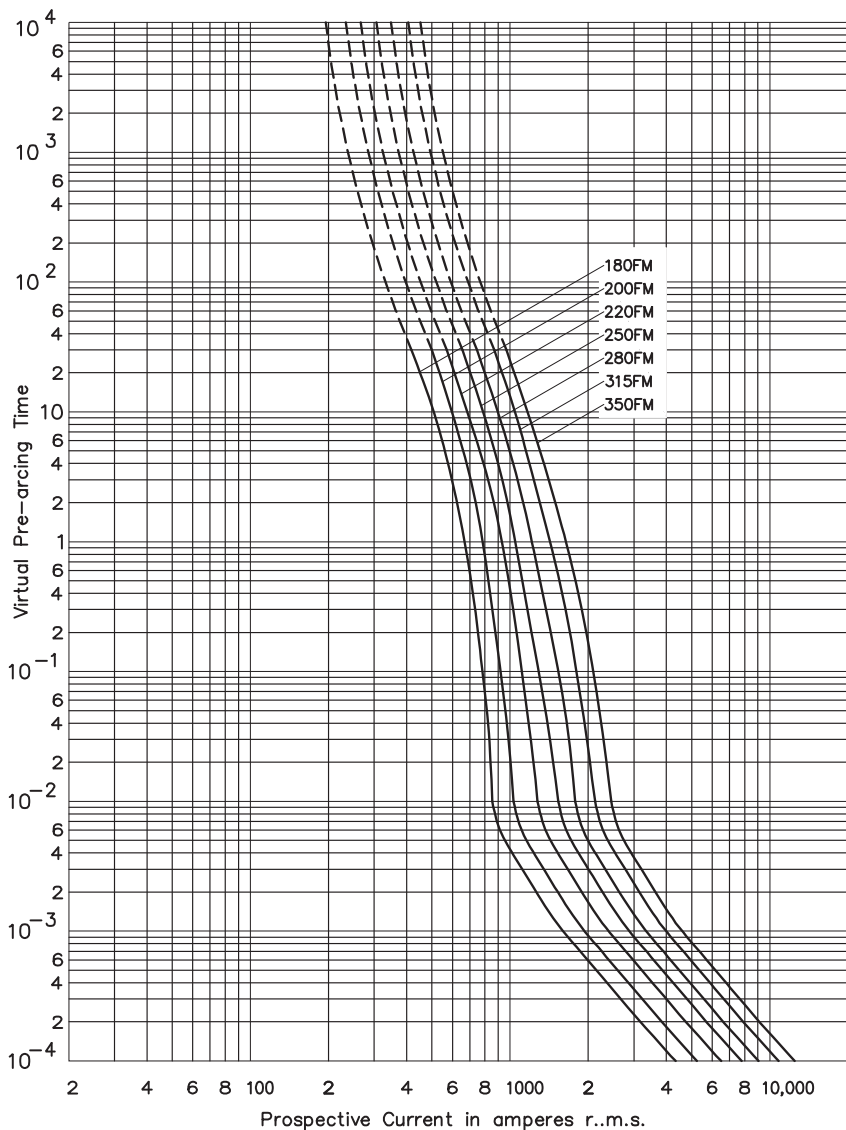

Data sheets: 720024, 5785314 (FM), 5785313 (MT), 5785292 (FMM), 5785311 (MMT)

**FM, FMM, MT, MMT** - 690 V a.c. / 350-450 V d.c. (IEC), 700 V a.c. / 500 V d.c. (UL), 160 A to 710 A

Time-current curve - MT, 160 A to 355 A

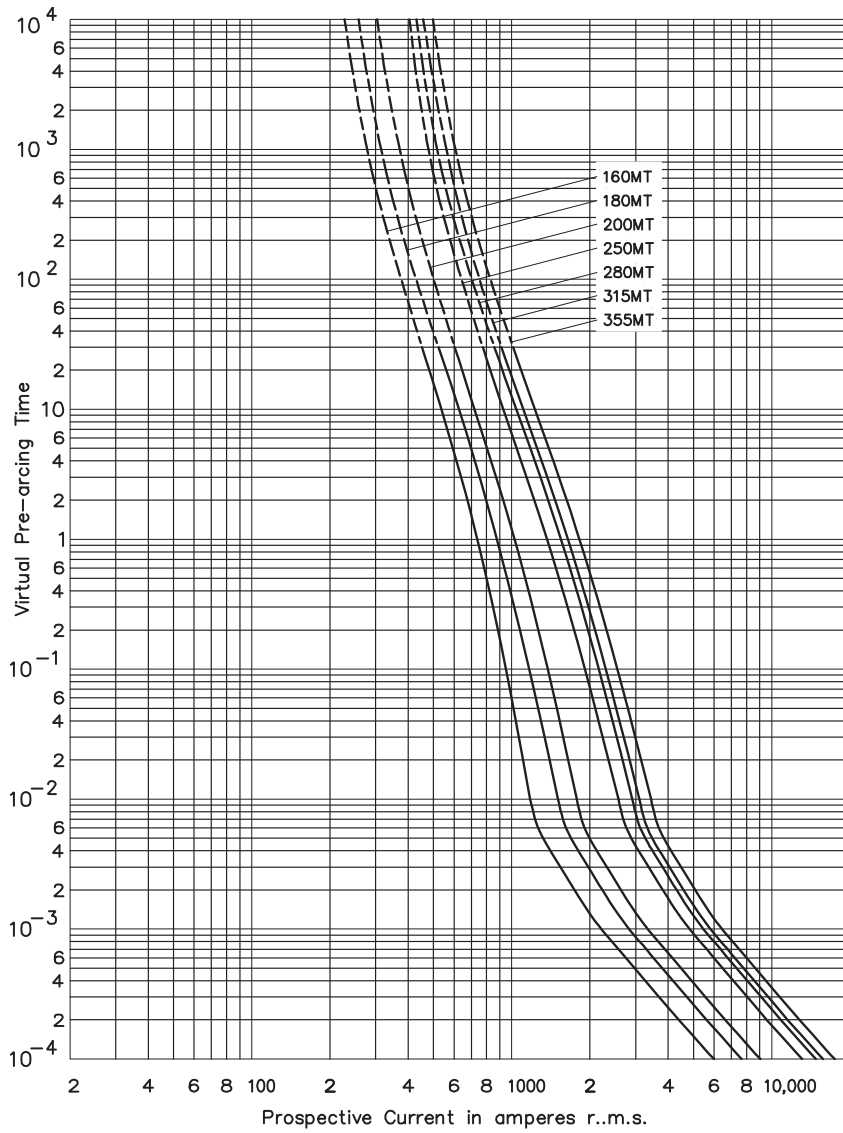

# British standard BS88 fuse links

**FM, FMM, MT, MMT** - 690 V a.c. / 350-450 V d.c. (IEC), 700 V a.c. / 500 V d.c. (UL), 160 A to 710 A

Time-current curve - FMM, 400 A to 700 A

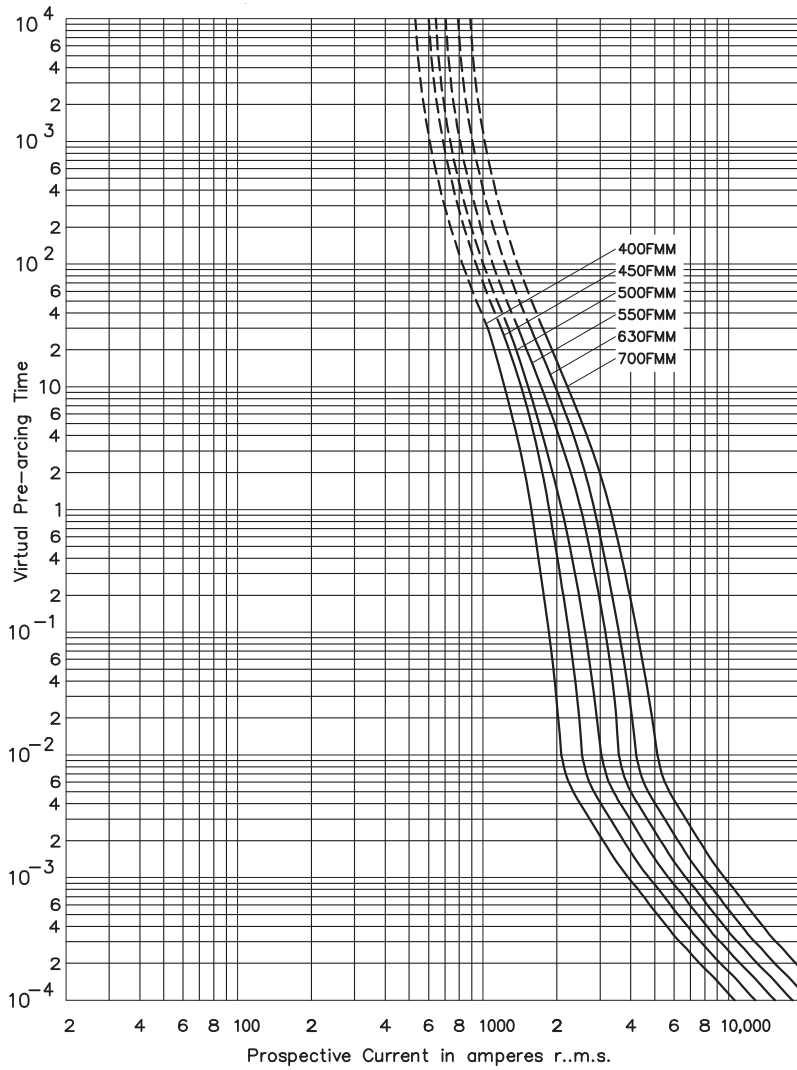

Data sheets: 720024, 5785314 (FM), 5785313 (MT), 5785292 (FMM), 5785311 (MMT)



**FM, FMM, MT, MMT - 690 V a.c. / 350-450 V d.c. (IEC), 700 V a.c. / 500 V d.c. (UL), 160 A to 710 A**

**Time-current curve - MMT, 180 A to 710 A**

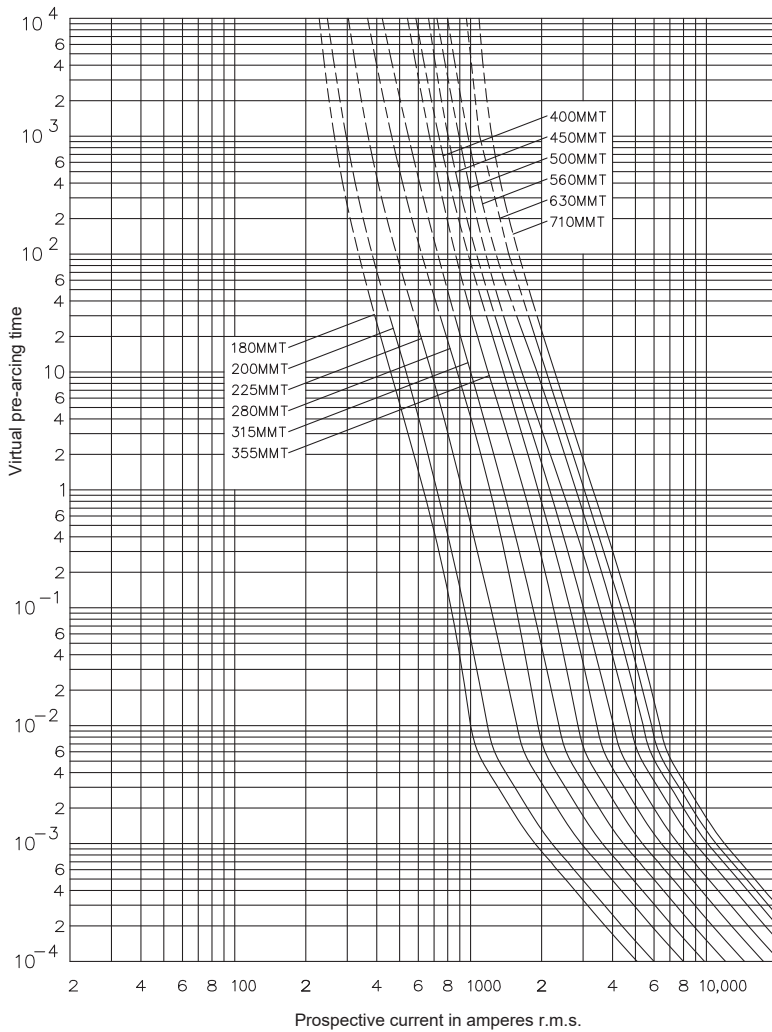

**Total clearing I<sup>2</sup>t**

The total clearing I<sup>2</sup>t at rated voltage and at a power factor of 15 percent are given in the electrical characteristics. For other voltages, the clearing I<sup>2</sup>t is found by multiplying by correction factor, K, given as a function of applied working voltage, E<sub>g</sub>, (RMS).

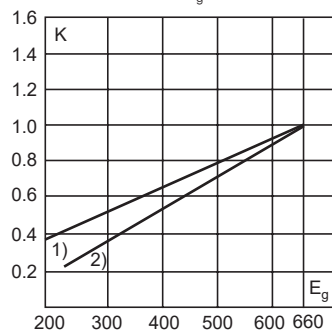

1) MT, MMT 2) FM, FMM

**Arc voltage**

This curve gives the peak arc voltage, U<sub>L</sub>, which may appear across the fuse during its operation as a function of the applied working voltage, E<sub>g</sub>, (RMS) at a power factor of 15 percent.

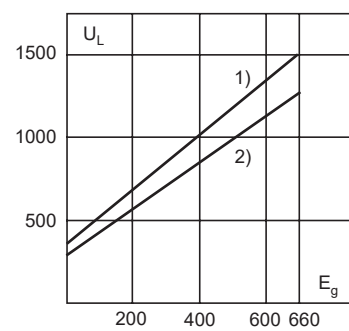

1) MT, MMT 2) FM, FMM

**Watts losses**

Watts loss at rated current is given in the electrical characteristics. The curve allows the calculation of the watts losses at load currents lower than the rated current. The correction factor, K<sub>p</sub>, is given as a function of the RMS load current, I<sub>b</sub>, in percent of the rated current.

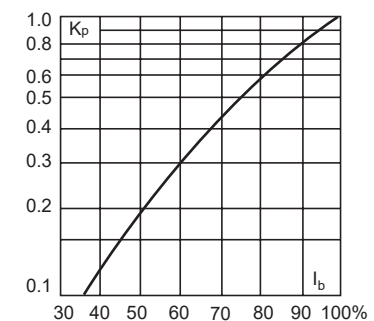

Data sheets: 720024, 5785314 (FM), 5785313 (MT), 5785292 (FMM), 5785311 (MMT)

# Ferrule fuse links

## FWA - 10 x 38 mm and 21 x 51 mm, 150 V a.c. / V d.c. (UL), 5 A to 60 A

### Specifications

#### Description

Ferrule style high speed fuse links for the protection of DC common bus, DC drives, power converters / rectifiers and reduced rated voltage starters.

#### Technical data

- Rated voltage: 150 V a.c. / V d.c. (UL)
- Rated current: 5 A to 60 A
- Breaking capacity:
  - 200 kA RMS Sym.
  - 50 kA DC at 150 V d.c.
- Operating class: aR

#### Standards / Agency information

CE, UL recognised



#### Catalogue numbers

Fuse link size	Rated voltage	Rated current (Amps)	I <sup>2</sup> t (A <sup>2</sup> Sec)		Watts loss (W)	Catalogue numbers
			Pre-arcing	Clearing at 150 V a.c.		
10 x 38 mm ( <sup>13</sup> / <sub>32</sub> " x 1½")	150 V a.c. / V d.c. (UL)	5	1.6	8	2	FWA-5A10F
		10	3.6	16	2.7	FWA-10A10F
		15	14	50	3.3	FWA-15A10F
		20	33	130	3.8	FWA-20A10F
		25	58	220	4.9	FWA-25A10F
		30	100	400	4.9	FWA-30A10F
21 x 51 mm ( <sup>13</sup> / <sub>16</sub> " x 2")	150 V a.c. / V d.c. (UL)	35	75	800	4.5	FWA-35A21F
		40	100	1000	5.1	FWA-40A21F
		45	130	1300	6	FWA-45A21F
		50	170	1600	7.3	FWA-50A21F
		55	210	1900	8	FWA-55A21F
		60	250	2400	8	FWA-60A21F

#### Dimensions - in (mm)

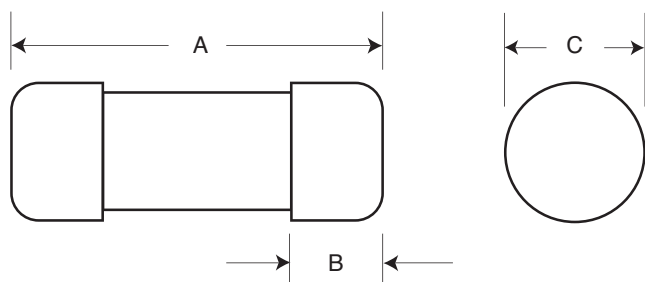

Amp range	A	B	C
5-30	1.5 (38.1)	0.38 (9.5)	0.41 (10.3)
35-60	2 (50.8)	0.63 (15.9)	0.81 (20.6)

Data sheets: 720003,5785317 (5-30 A), 5785305 (35-60 A)

**FWA - 10 x 38 mm and 21 x 51 mm, 150 V a.c. / V d.c. (UL), 5 A to 60 A**

Time-current curve - 5 A to 30 A

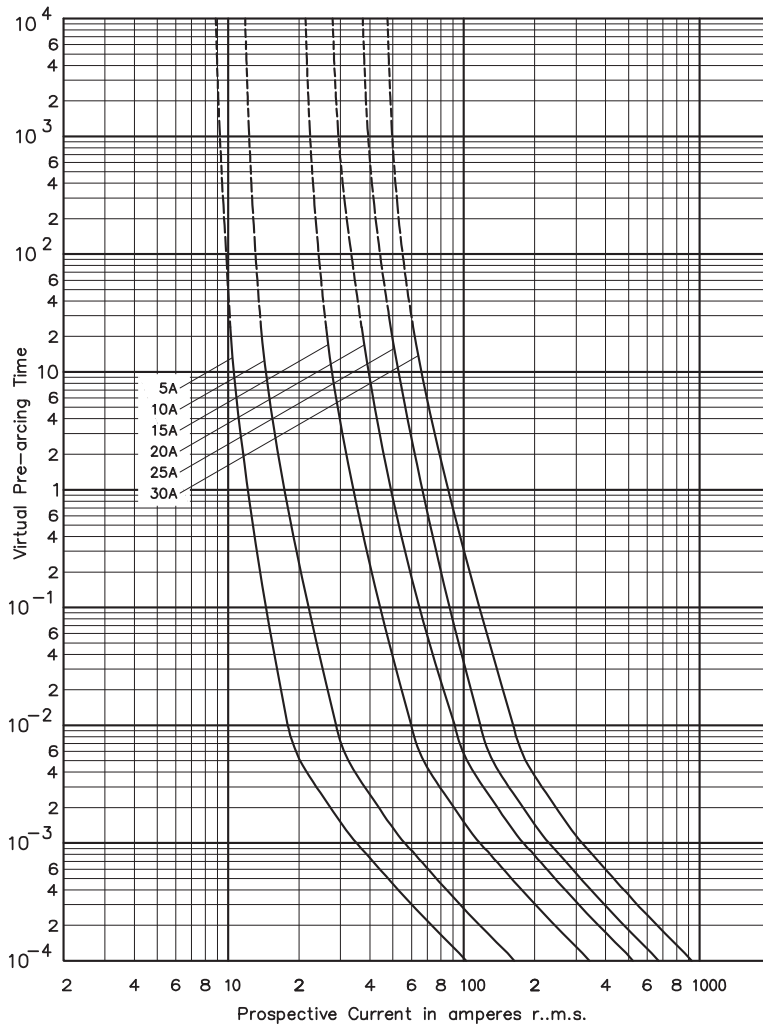

Data sheets: 720003,5785317 (5-30 A), 5785305 (35-60 A)

# Ferrule fuse links

## FWA - 10 x 38 mm and 21 x 51 mm, 150 V a.c. / V d.c. (UL), 5 A to 60 A

### Time-current curve - 35 A to 60 A

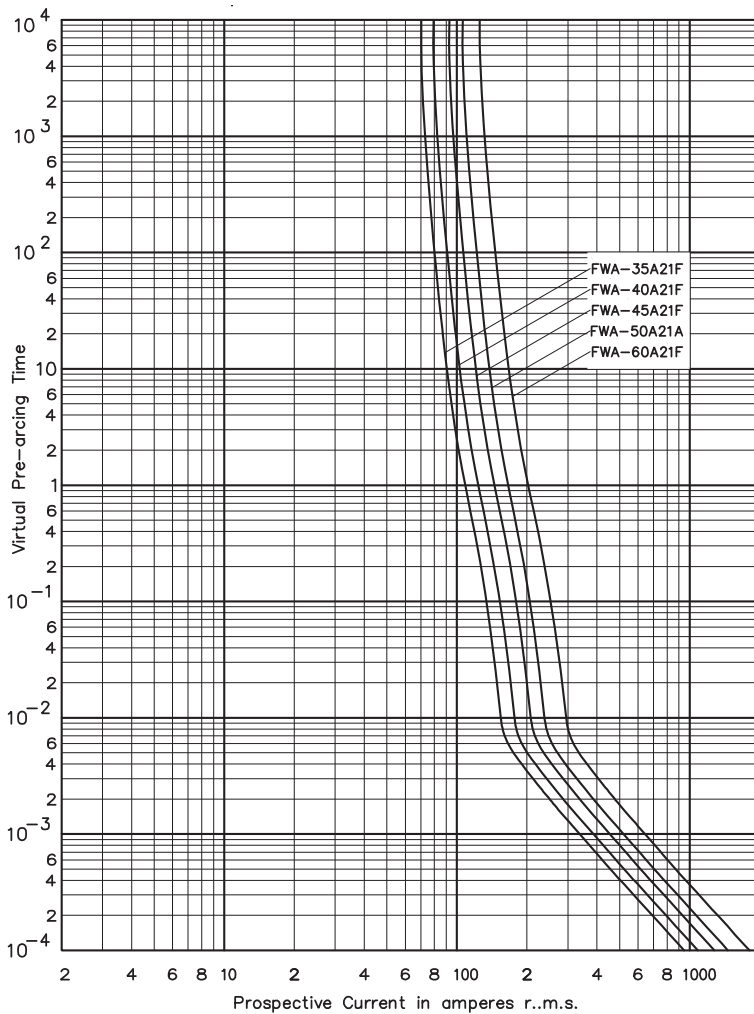

### Total clearing $I^2t$

The total clearing  $I^2t$  at rated voltage and at a power factor of 15 percent are given in the electrical characteristics. For other voltages, the clearing  $I^2t$  is found by multiplying by correction factor, K, given as a function of applied working voltage,  $E_g$ , (RMS).

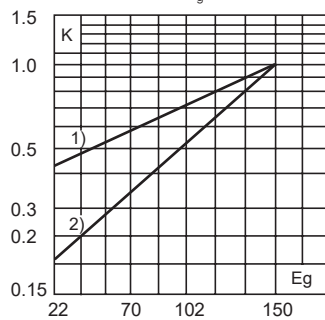

- 1) 5 - 30 A
- 2) 35 - 60 A

### Arc voltage

This curve gives the peak arc voltage,  $U_L$ , which may appear across the fuse during its operation as a function of the applied working voltage,  $E_g$ , (RMS) at a power factor of 15 percent.

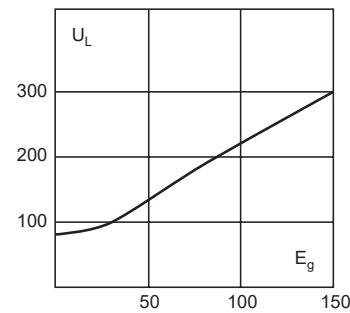

### Watts losses

Watts loss at rated current is given in the electrical characteristics. The curve allows the calculation of the watts losses at load currents lower than the rated current. The correction factor,  $K_p$ , is given as a function of the RMS load current,  $I_b$ , in percent of the rated current.

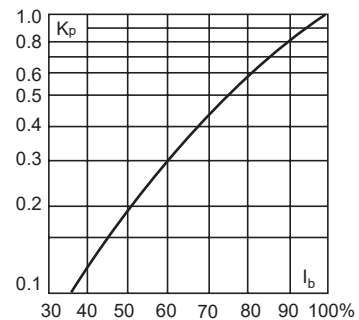

Data sheets: 720003,5785317 (5-30 A), 5785305 (35-60 A)

**FWX - 14 x 51 mm, 250 V a.c. / V d.c. (UL), 1 A to 50 A**

**Specifications**

**Description**

Ferrule style high speed fuse links for the protection of DC common bus, DC drives, power converters/rectifiers rated voltage starters.

**Technical data**

- Rated voltage: see details in table below
- Rated current: 1 A to 50 A
- Breaking capacity:
  - 200 kA RMS Sym. (UL, all ratings)
  - 50 kA at 250 V d.c. (UL, 5 A to 30 A only)
- Operating class: aR

**Compatible modular fuse holder**

- CH14

**Standards / Agency information**

CE, UL recognised 1-50 A & CSA component acceptance: 5 A to 30 A



**Catalogue numbers**

Fuse link size	Rated voltage	Rated current (Amps)	I <sup>2</sup> t (A <sup>2</sup> Sec)		Watts loss (W)	Catalogue numbers
			Pre-arcing	Clearing at 250 V a.c.		
14 x 51mm ( <sup>9</sup> / <sub>16</sub> " x 2")	250 V a.c. (UL)	1	0.04	0.12	5.7	FWX-1A14F
		2	0.08	0.28	8.7	FWX-2A14F
		3	0.11	0.39	2.8	FWX-3A14F
		4	0.1	0.35	3	FWX-4A14F
	250 V a.c. / 250 V d.c. (UL)	5	1.6	13	1.3	FWX-5A14F
		10	3.6	24	3.4	FWX-10A14F
		15	14	83	3.8	FWX-15A14F
		20	33	200	4.6	FWX-20A14F
		25	58	300	5.3	FWX-25A14F
		30	100	500	5.9	FWX-30A14F
	250 V a.c. (UL)	50	200	1800	5.7	FWX-50A14F

**Dimensions - mm (in)**

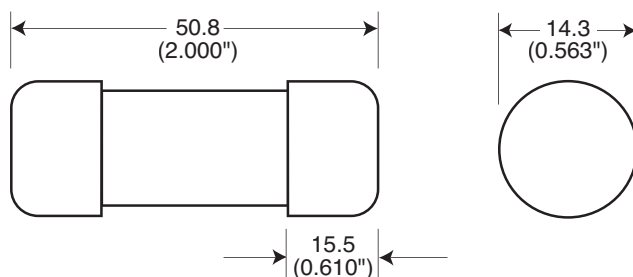

# Ferrule fuse links

## FWX - 14 x 51 mm, 250 V a.c. / V d.c. (UL), 1 A to 50 A

### Time-current curve - 1 A to 4 A

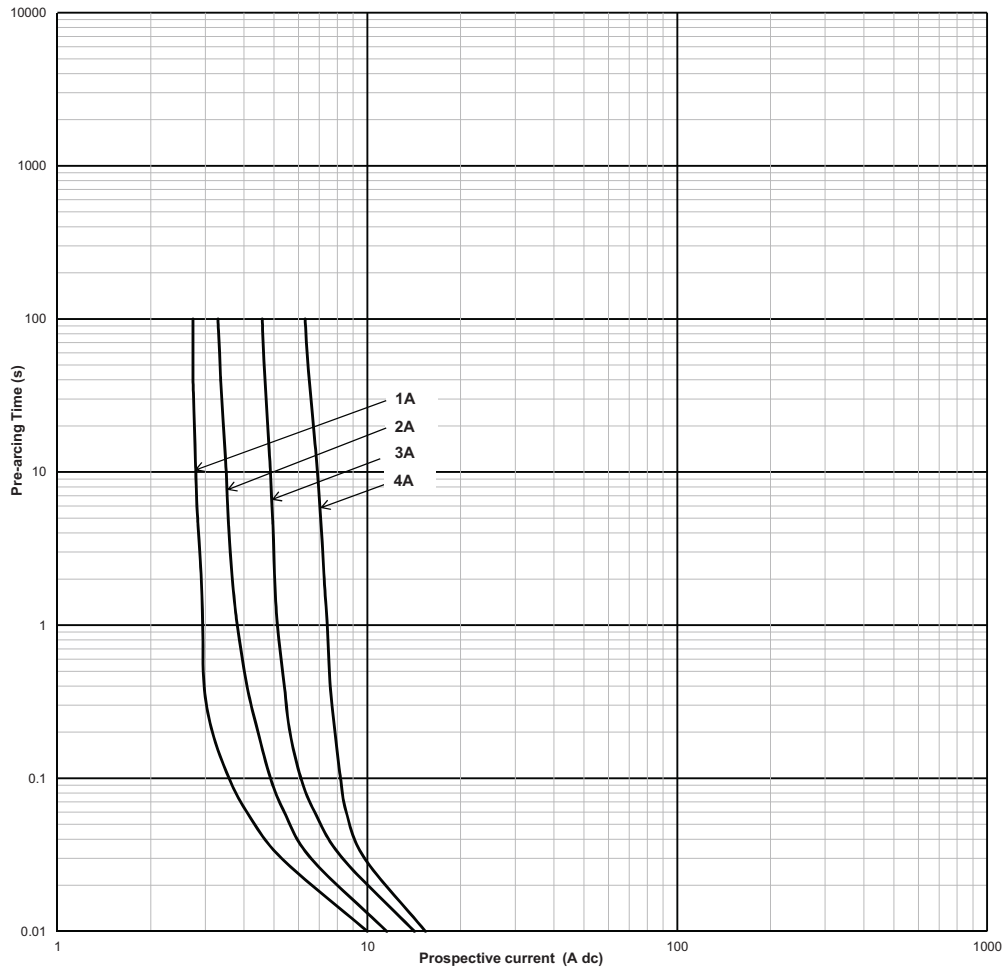

**FWX - 14 x 51 mm, 250 V a.c. / V d.c. (UL), 1 A to 50 A**

**Time-current curve - 5 A to 50 A**

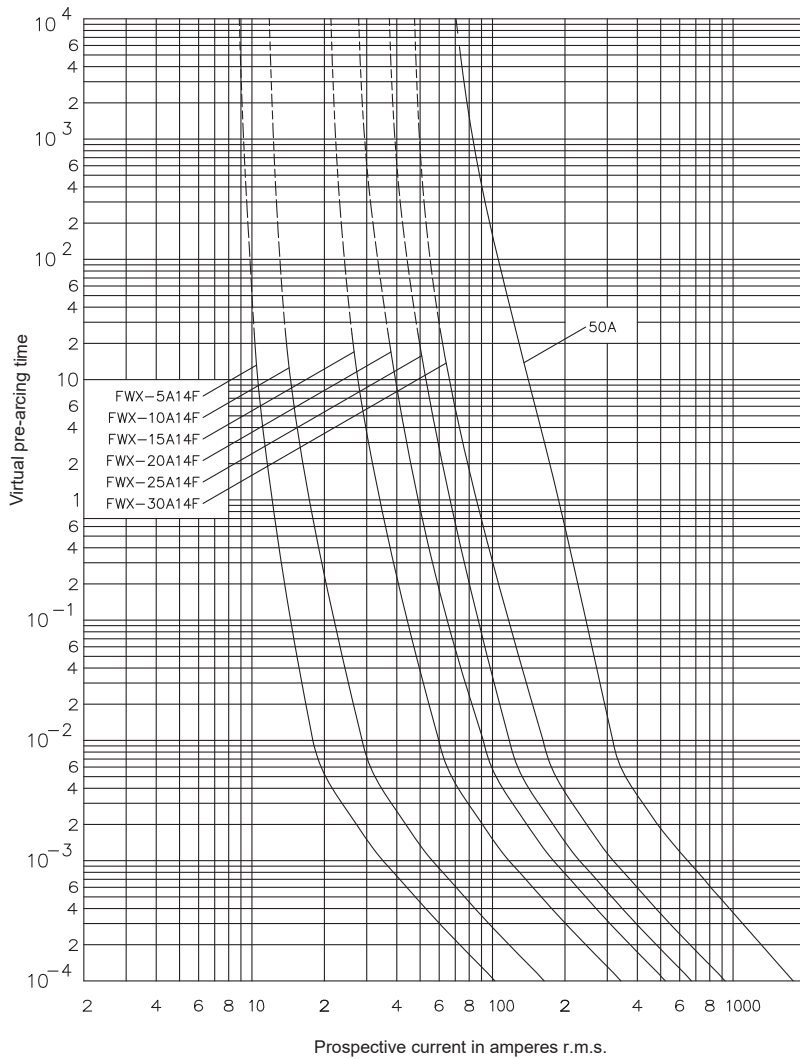

**Total clearing I<sup>2</sup>t**

The total clearing I<sup>2</sup>t at rated voltage and at a power factor of 15 percent are given in the electrical characteristics. For other voltages, the clearing I<sup>2</sup>t is found by multiplying by correction factor, K, given as a function of applied working voltage, E<sub>g</sub>, (RMS).

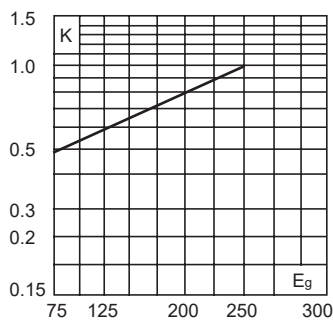

**Arc voltage**

This curve gives the peak arc voltage, U<sub>L</sub>, which may appear across the fuse during its operation as a function of the applied working voltage, E<sub>g</sub>, (RMS) at a power factor of 15 percent.

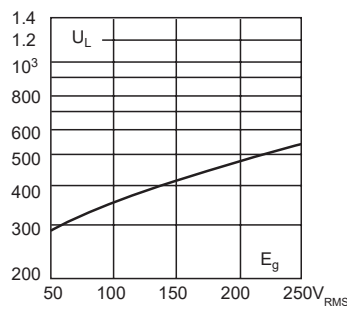

**Watts losses**

Watts loss at rated current is given in the electrical characteristics. The curve allows the calculation of the watts losses at load currents lower than the rated current. The correction factor, K<sub>p</sub>, is given as a function of the RMS load current, I<sub>b</sub>, in percent of the rated current.

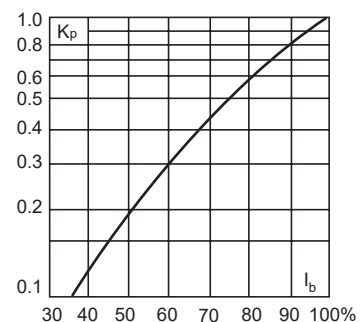

Data sheets: 720006, 5785580, 5785302

# Ferrule fuse links

## FWH - 6 x 32 mm, 500 V a.c. (UL), 0.25 A to 30 A

### Specifications

#### Description

Ferrule style high speed fuse links for the protection of DC common bus, DC drives, power converters/rectifiers and reduced rated voltage starters.

#### Technical data

- Rated voltage:
  - 500 V a.c. (UL)
  - 1000 V a.c. (UL, 2 A only)
  - 600 V d.c. (UL, 4 A and 5 A only)
- Rated current: 0.25 A to 30 A
- Breaking capacity:
  - 50 kA (0.25 A to 20 A)
  - 20 kA (25 A to 30 A, tested at PF = 76%)
  - 50 kA at 600 V d.c. (UL 2 A and 5 A only)
- Operating class: aR

#### Standards / Agency information

CE, UL recognised 0.25 A to 30 A including 2 A at 1000 V a.c.,  
CSA component Acceptance: 0.25 A to 7 A



#### Catalogue numbers

Fuse link size	Rated voltage	Rated current (Amps)	I <sup>2</sup> t (A <sup>2</sup> Sec)		Watts loss (W)	Catalogue numbers
			Pre-arcing	Clearing at 500 V a.c.		
6 x 32 mm (¼" x 1¼")	500 V a.c. (UL)	0.25	0.01	0.05	2.7	FWH--250A6F
		0.5	0.05	0.25	1.2	FWH--500A6F
		1	0.4	2	1.7	FWH-001A6F
	1000 V a.c. (UL)	2	1.3	3.5	3.2	FWH-002A6F
	500 V a.c. (UL)	3.15	3.1	7.7	2.9	FWH-3-15A6F
	500 V a.c. / 600 V d.c. (UL)	4	8.4	22	2.4	FWH-004A6F
		5	15	40	2.1	FWH-005A6F
	500 V a.c. (UL)	6.3	36	90	2.3	FWH-6-30A6F
		7	50	125	2.5	FWH-007A6F
		10	9.9	139	2.86	FWH5-010A6F
		12.5	20	60	3.53	FWH5-12-5A6F
		15	44	146	3.08	FWH5-015A6F
		16	48	177	4.48	FWH5-016A6F
	500 V a.c. (UL)	20	75	259	4.26	FWH5-020A6F
		25	126	345	-	FWH-025A6F
		30	145	430	-	FWH-030A6F

#### Dimensions mm (in)

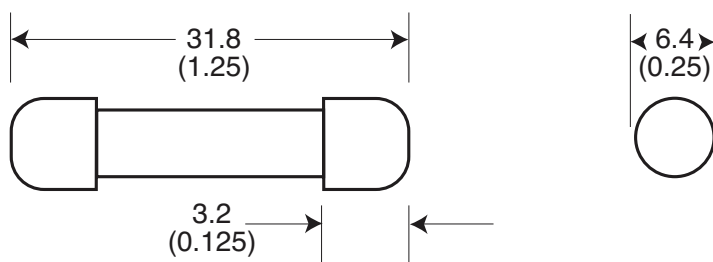

Data sheets: 720038, 5785256 (0.25-7A), 50955 (10-30 A)



**FWH - 6 x 32 mm, 500 V a.c. (UL), 0.25 A to 30 A**

Time-current curve - 0.25 A to 7 A

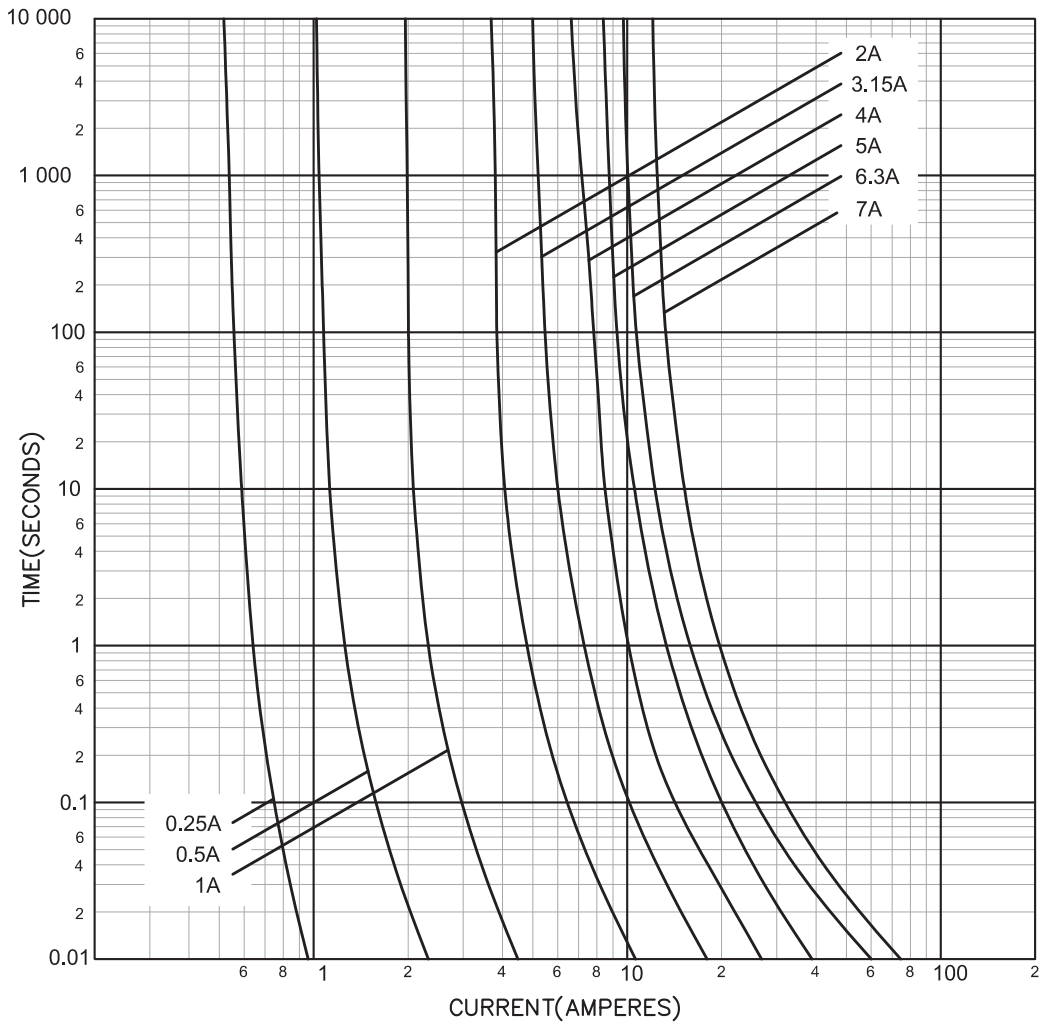

# Ferrule fuse links

## FWH - 14 x 51 mm, 500 V a.c. / V d.c. (UL), 1 A to 30 A

### Specifications

#### Description

Ferrule style high speed fuse links for the protection of DC common bus, DC drives, power converters/rectifiers and reduced rated voltage starters.

#### Technical data

- Rated voltage:
  - 500 V a.c. (UL, all ratings)
  - 500 V d.c. (UL, 5 A to 30 A only)
- Rated current: 1 A to 30 A
- Breaking capacity:
  - 200 kA RMS Sym. all ratings
  - 50 kA at 500 V d.c. (5 A to 30 A only)
- Operating class: aR

#### Compatible modular fuse holder

- CH14

#### Standards / Agency information

CE, UL Recognised 1 A to 30 A & CSA Component Acceptance: 5 A to 30 A



### Catalogue numbers

Fuse link size	Rated voltage	Rated current (Amps)	Pt (A <sup>2</sup> Sec)		Watts loss (W)	Catalogue numbers
			Pre-arcing	Clearing at 500 V a.c.		
14 x 51 mm (9/16" x 2")	500 V a.c.(UL)	1	0.04	0.41	5.7	FWH-1A14F
		2	0.08	0.11	8.7	FWH-2A14F
		3	0.11	0.26	2.8	FWH-3A14F
		4	0.1	0.23	3	FWH-4A14F
	500 V a.c. / V d.c. (UL)	5	2	7	1.5	FWH-5A14F
		6	2	7	1.5	FWH-6A14F
		10	4	15	4	FWH-10A14F
		12	7	25	4.3	FWH-12A14F
		15	10	40	5.5	FWH-15A14F
		20	26	100	6.5	FWH-20A14F
		25	49	200	7	FWH-25A14F
		30	58	240	9	FWH-30A14F

### Dimensions mm (in)

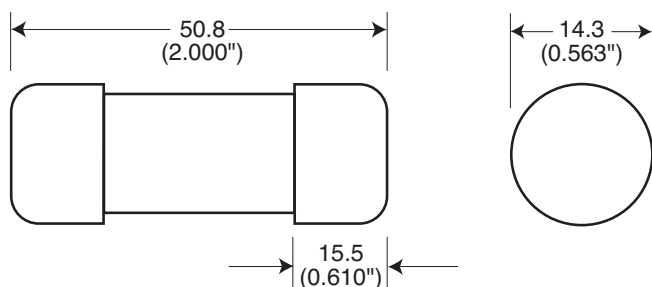

Data sheets: 720008, 5785298, 5785578

**FWH - 14 x 51 mm, 500 V a.c. / V d.c. (UL), 1 A to 30 A**

**Time-current curve - 1 A to 30 A**

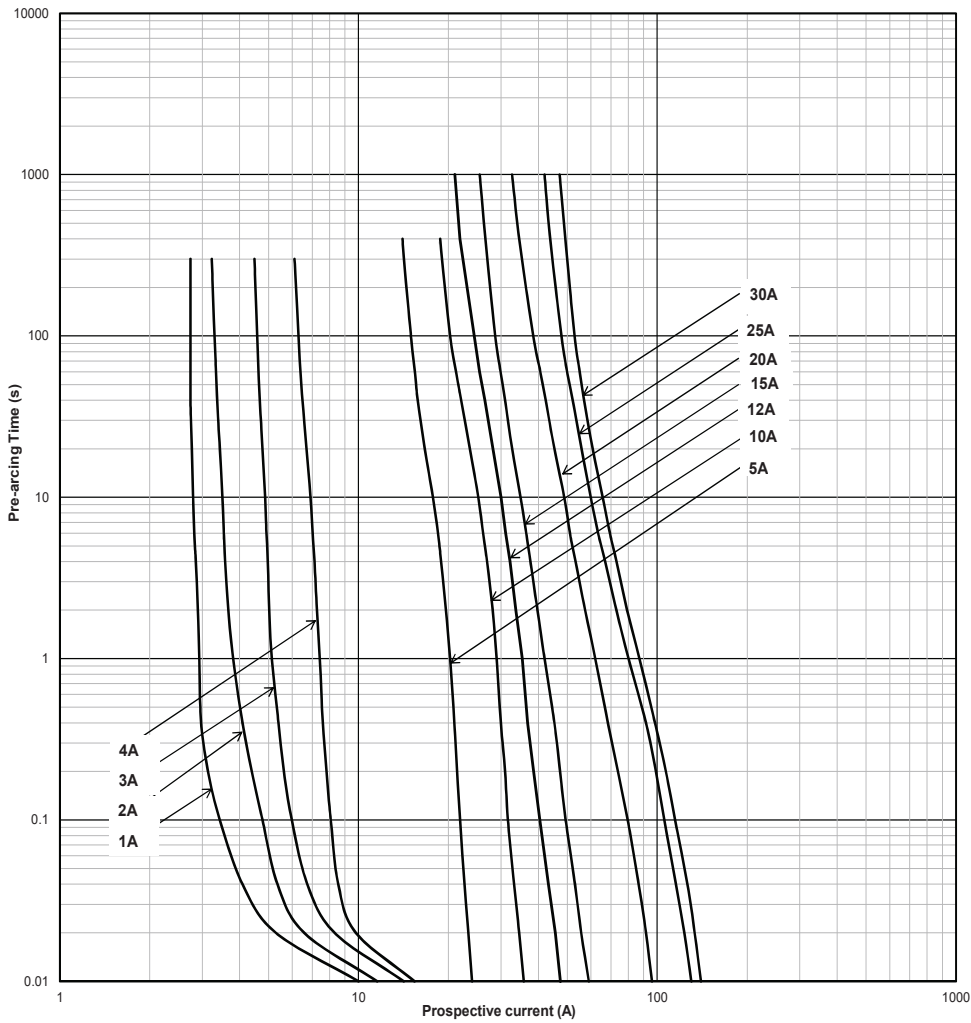

**Total clearing I<sup>2</sup>t**

The total clearing I<sup>2</sup>t at rated voltage and at a power factor of 15 percent are given in the electrical characteristics. For other voltages, the clearing I<sup>2</sup>t is found by multiplying by correction factor, K, given as a function of applied working voltage, E<sub>g</sub>, (RMS).

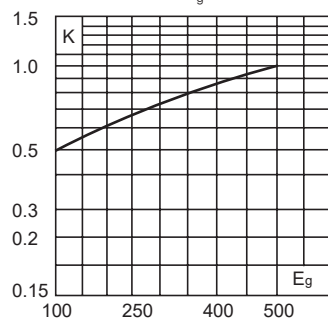

**Arc voltage**

This curve gives the peak arc voltage, U<sub>L</sub>, which may appear across the fuse during its operation as a function of the applied working voltage, E<sub>g</sub>, (RMS) at a power factor of 15 percent.

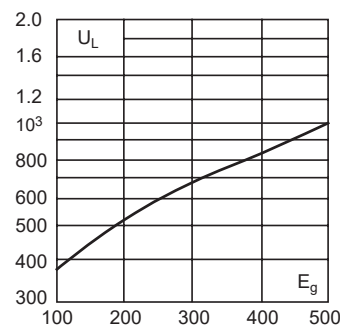

**Watts losses**

Watts loss at rated current is given in the electrical characteristics. The curve allows the calculation of the watts losses at load currents lower than the rated current. The correction factor, K<sub>p</sub>, is given as a function of the RMS load current, I<sub>b</sub>, in percent of the rated current.

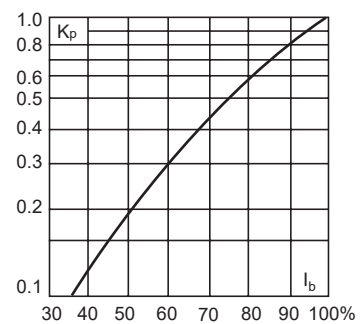

# Ferrule fuse links

## FWC - 10 x 38 mm, 600-700 V a.c. / 700 V d.c. (UL), 1 A to 32A

### Specifications

#### Description

Ferrule style high speed fuse links for the protection of DC common bus, DC drives, power converters/rectifiers and reduced rated voltage starters.

#### Technical data

- Rated voltage:
  - 700 V a.c. / V d.c. (UL, 1 A to 4 A)
  - 600 V a.c. (UL, 6 A to 32 A), 700 V d.c. (UL, 6 A to 25 A)
- Rated current: 1 A to 32 A
- Breaking capacity:
  - 200 kA RMS Sym. at 600 V a.c. (6 A to 32 A)
  - 200 kA RMS Sym. at 700 V a.c. (1 A to 4 A)
  - 10 kA DC at 700 V d.c. (1 A to 25 A)
- Operating class: aR

#### Standards / Agency information

CE, UL Recognised: 6 A to 32 A



#### Catalogue numbers

Fuse link size	Rated voltage	Rated current (Amps)	I <sup>2</sup> t (A <sup>2</sup> Sec)		Watts loss (W)	Catalogue numbers
			Pre-arcing	Clearing at 600 V a.c.		
10 x 38 mm ( <sup>13</sup> / <sub>32</sub> " x 1½")	700 V a.c. / V d.c. (UL)	1	0.2	1.2	0.5	FWC-1A10F
		2	0.5	3	1.2	FWC-2A10F
		3	1.6	11	1.5	FWC-3A10F
		4	5.2	32	1.5	FWC-4A10F
		6	4	30	1.5	FWC-6A10F
	600 V a.c. / 700 V d.c. (UL)	8	6	50	2	FWC-8A10F
		10	9	70	2.5	FWC-10A10F
		12	15	120	3	FWC-12A10F
		16	25	150	3.5	FWC-16A10F
		20	34	260	4.8	FWC-20A10F
	600 V a.c. (UL)	25	60	390	6	FWC-25A10F
		30	95	600	7.5	FWC-30A10F
		32	95	600	7.5	FWC-32A10F

#### Dimensions - mm (in)

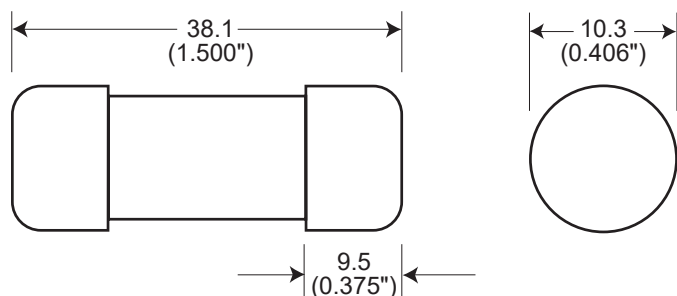

**FWC - 10 x 38 mm, 600-700 V a.c. / 700 V d.c. (UL), 1 A to 32A**

Time-current curve - 1 A to 32 A

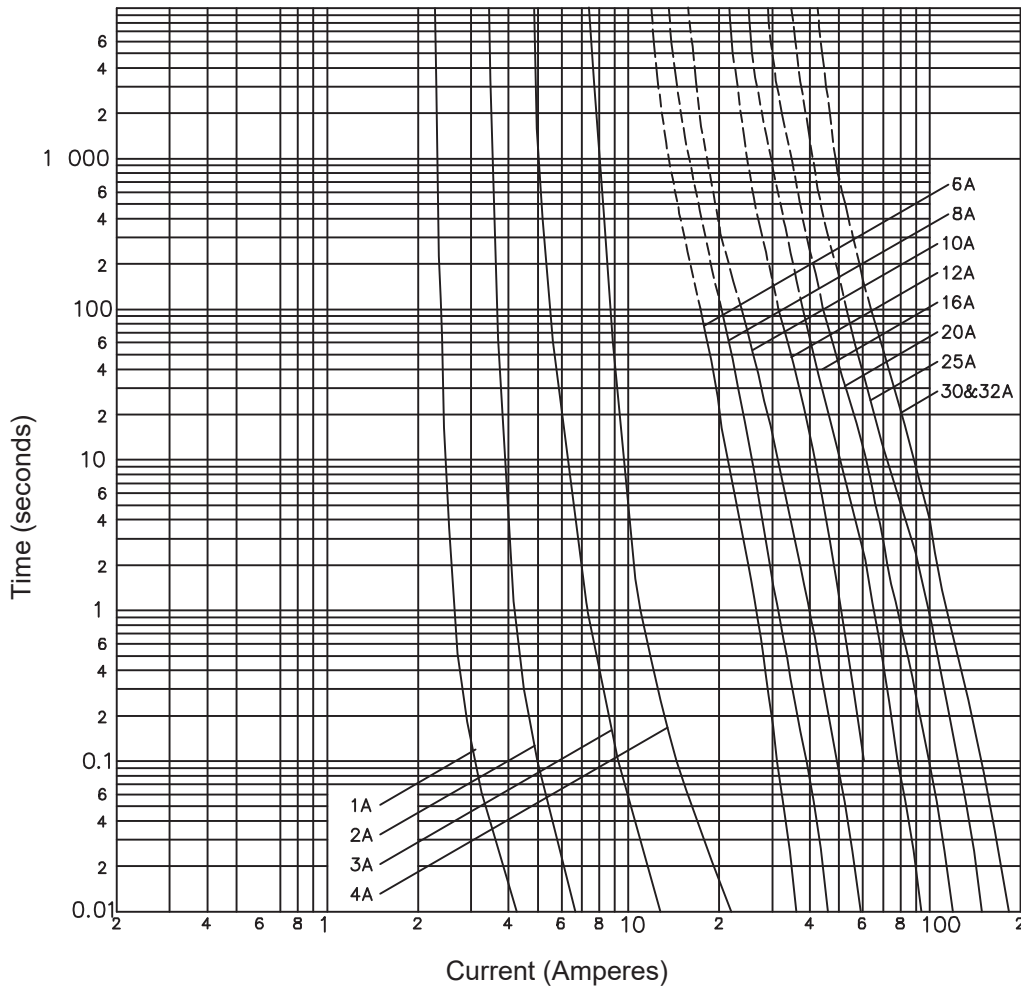

**Total clearing I<sup>2</sup>t**

The total clearing I<sup>2</sup>t at rated voltage and at a power factor of 15 percent are given in the electrical characteristics. For other voltages, the clearing I<sup>2</sup>t is found by multiplying by correction factor, K, given as a function of applied working voltage, E<sub>g</sub>, (RMS).

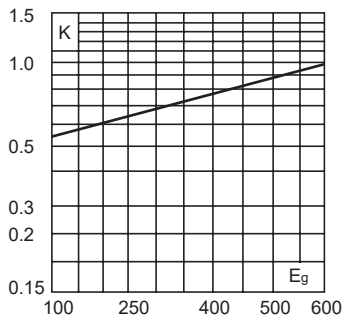

**Arc voltage**

This curve gives the peak arc voltage, U<sub>L</sub>, which may appear across the fuse during its operation as a function of the applied working voltage, E<sub>g</sub>, (RMS) at a power factor of 15 percent.

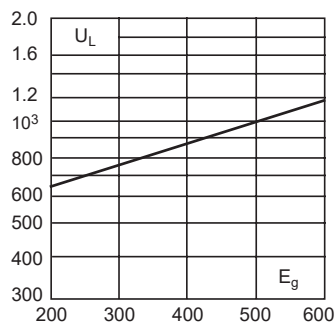

**Watts losses**

Watts loss at rated current is given in the electrical characteristics. The curve allows the calculation of the watts losses at load currents lower than the rated current. The correction factor, K<sub>p</sub>, is given as a function of the RMS load current, I<sub>b</sub>, in percent of the rated current.

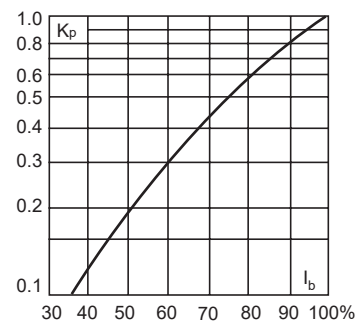

# Ferrule fuse links

## FWP - 10 x 38 mm, gR, 690 V a.c. (IEC), 4 A to 32 A

### Specifications

#### Description

The 10 x 38 mm cylindrical, class gR fuse links are used to protect AC/DC Drives and semi-conductors.

#### Technical data

- Rated voltage: see details in table below
- Rated current: 4 A to 32 A
- Breaking capacity: 200 kA a.c.
- Operating class: gR

#### Compatible fuse holder

CHM

#### Standards / Agency information

IEC 60269-4, UL 248-13



#### Catalogue numbers

Fuse link size	Type	Rated voltage	Rated current (Amps)	I <sup>2</sup> t (A <sup>2</sup> Sec)		Watts loss (W)	Catalogue numbers
				Pre-arcing	Clearing at 690 V a.c.		
10 x 38 mm	Without indicator	690 V a.c. (IEC)	4	5.6	17	2.05	FWP-4G10F
		500 V d.c.. (UL)	6	16	48	3	FWP-6G10F
		690 V a.c. (IEC)	8	4.3	38	1.68	FWP-8G10F
			10	6.6	59	2.09	FWP-10G10F
			12	9.6	84	2.99	FWP-12G10F
			16	17	150	4.27	FWP-16G10F
			20	23.5	200	5.35	FWP-20G10F
			25	60.2	512	5.52	FWP-25G10F
			32	94	800	7.43	FWP-32G10F
			700 V a.c. (UL)				

#### Dimensions (mm)

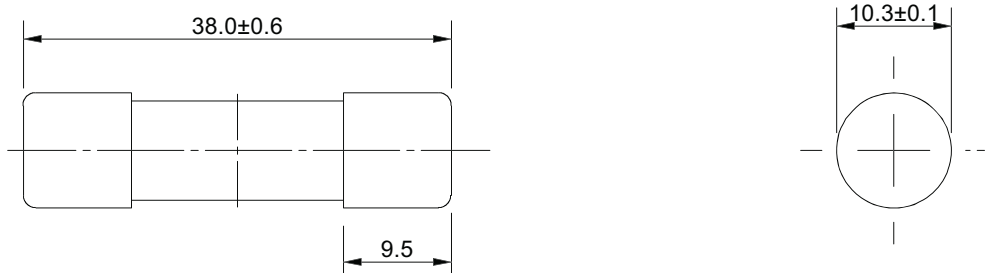

**FWP - 10 x 38 mm, gR, 690 V a.c., 4 A to 32 A**

**Time-current curve - 4 A to 32 A**

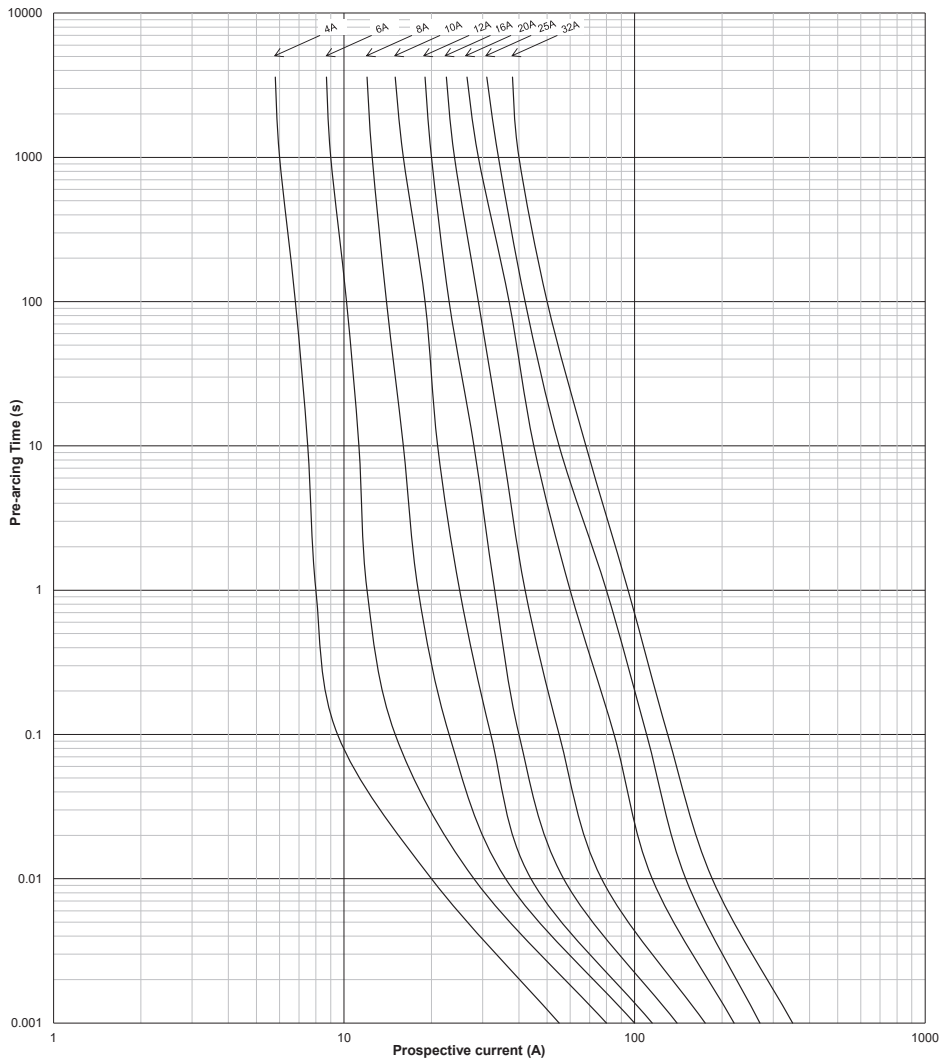

**Ambient temperature**

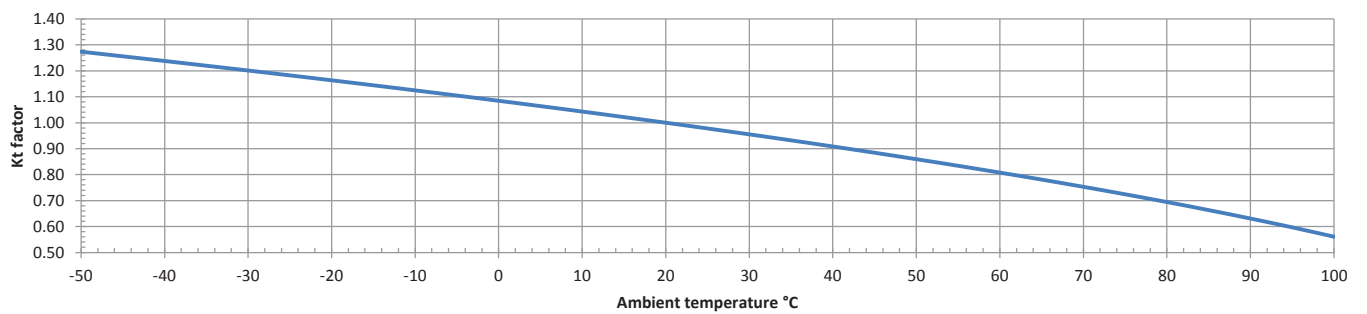

# Ferrule fuse links

## FWP - 10 x 38 mm, gR, 690 V a.c., 4 A to 32 A

### Cut-off curve- 2 A to 32 A

Peak let through current ( $I_{peak}$ ) vs. Prospective Short Circuit Current in SYMM. RMS value, 50Hz / p.f. > 0.15

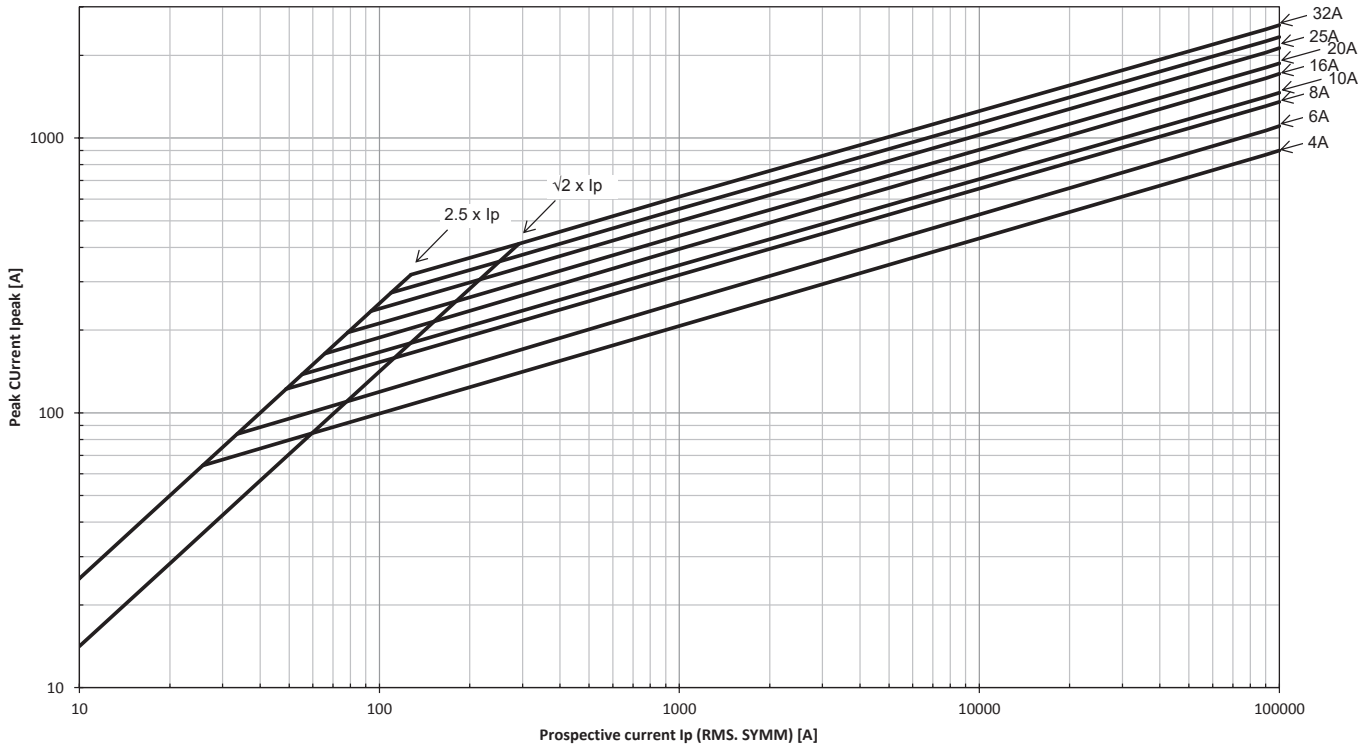

### Total clearing $I^2t$

The total clearing  $I^2t$  at rated voltage and at a power factor of 15 percent are given in the electrical characteristics. For other voltages, the clearing  $I^2t$  is found by multiplying by correction factor,  $K$ , given as a function of applied working voltage,  $E_g$ , (RMS).

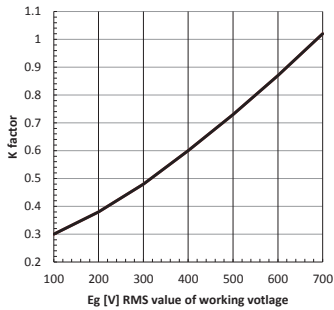

### Arc voltage

This curve gives the peak arc voltage,  $U_L$ , which may appear across the fuse during its operation as a function of the applied working voltage,  $E_g$ , (RMS) at a power factor of 15 percent.

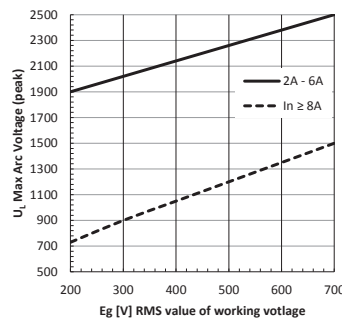

### Watts losses

Watts loss at rated current is given in the electrical characteristics. The curve allows the calculation of the watts losses at load currents lower than the rated current. The correction factor,  $K_p$ , is given as a function of the RMS load current,  $I_b$ , in percent of the rated current.

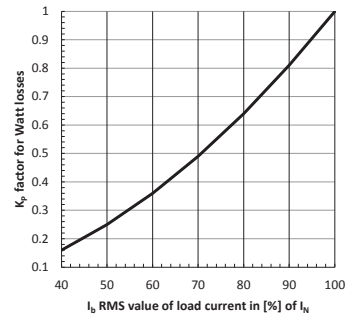



## FWP - 14 x 51 mm, gR, 690 V a.c. (IEC), 4 A to 50 A

### Specifications

#### Description

The 14 x 51 mm cylindrical, class gR fuse links are used to protect AC/DC Drives and semi-conductors.

#### Technical data

- Rated voltage: 690 V a.c. (IEC)
- Rated current: 4 A to 50 A
- Breaking capacity: 200 kA a.c.
- Operating class: gR

#### Compatible modular fuse holder

- CH14

#### Standards / Agency information

IEC 60269-4, UL 248-13



#### Catalogue numbers

Fuse link size	Type	Rated voltage	Rated current (Amps)	I <sup>2</sup> t (A <sup>2</sup> Sec)		Watts loss (W)	Catalogue numbers
				Pre-arcing	Clearing at 690 V a.c.		
14 x 51 mm	Without indicator	690 V a.c. (IEC)	4	5.6	17	2.94	FWP-4G14F
			6	16	48	4.2	FWP-6G14F
			8	3.8	30	2	FWP-8G14F
			10	5.9	47	2.52	FWP-10G14F
			12	8.4	68	3.54	FWP-12G14F
			16	15	120	4.83	FWP-16G14F
			20	27	170	5.4	FWP-20G14F
			25	53	333	6	FWP-25G14F
			32	108	679	6.93	FWP-32G14F
			40	211	1331	7.52	FWP-40G14F
	With indicator	690 V a.c. (IEC)	8	3.8	30	2	FWP-8G14FI
			10	5.9	47	2.52	FWP-10G14FI
			12	8.4	68	3.54	FWP-12G14FI
			16	15	120	4.83	FWP-16G14FI
			20	27	170	5.4	FWP-20G14FI
			25	53	333	6	FWP-25G14FI
			32	108	679	6.93	FWP-32G14FI
			40	211	1331	7.52	FWP-40G14FI
			50	350	2200	9.8	FWP-50G14FI

#### Dimensions (mm)

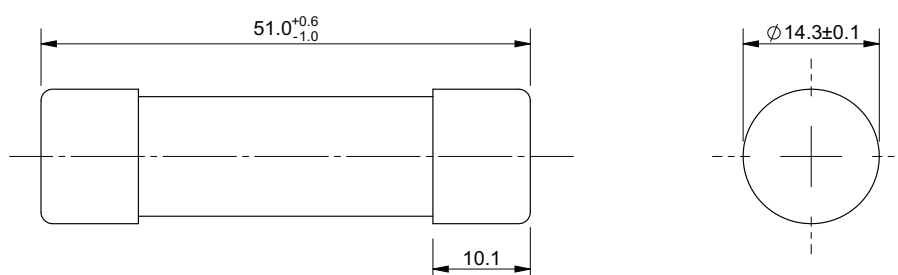

Data sheet: 10468

# Ferrule fuse links

## FWP - 14 x 51 mm, gR, 690 V a.c., 4 A to 50 A

### Time-current curve - 4 A to 50 A

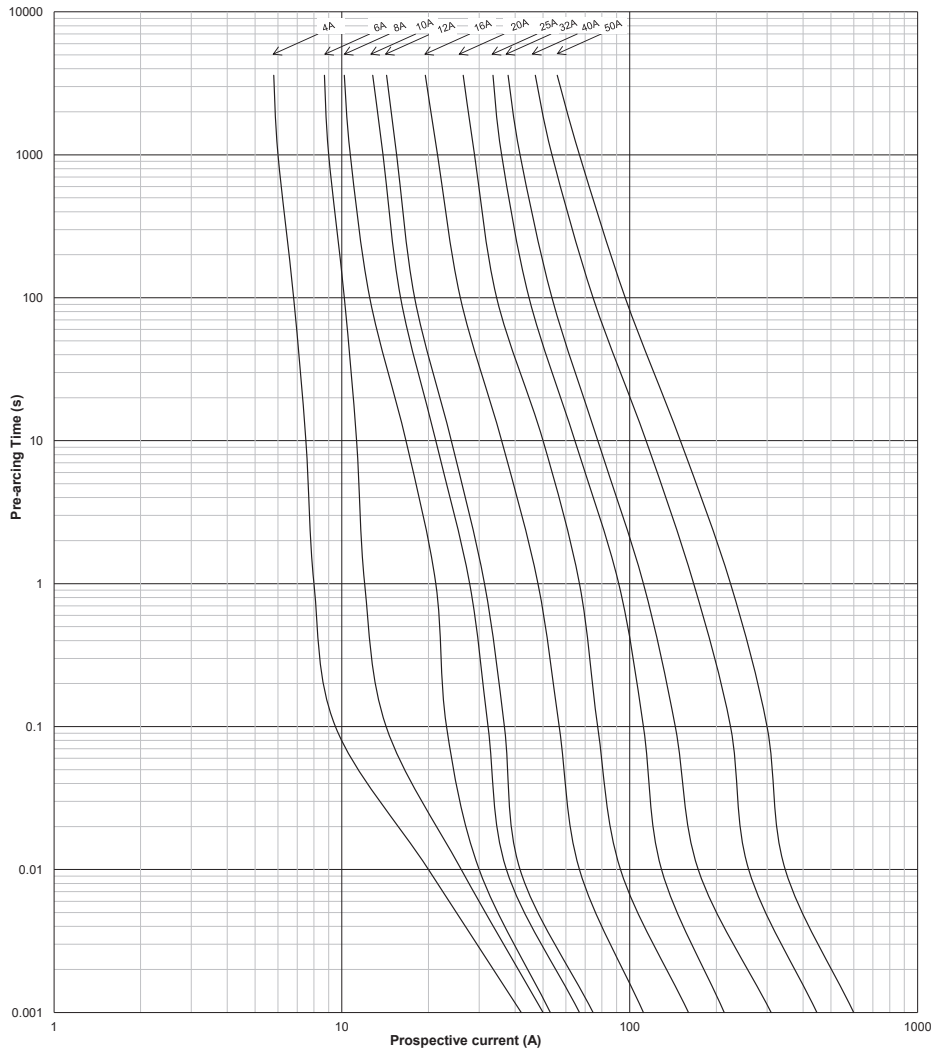

### Ambient temperature

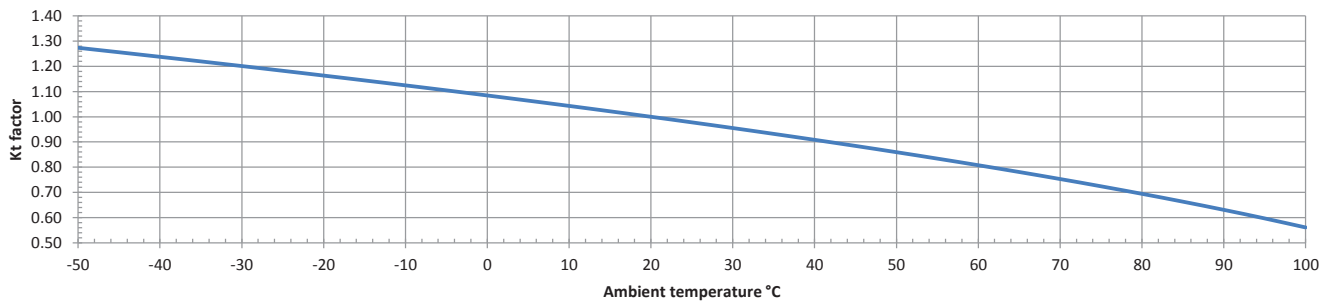

# FWP - 14 x 51 mm, gR, 690 V a.c., 4 A to 50 A

## Cut-off curve - 4 A to 50 A

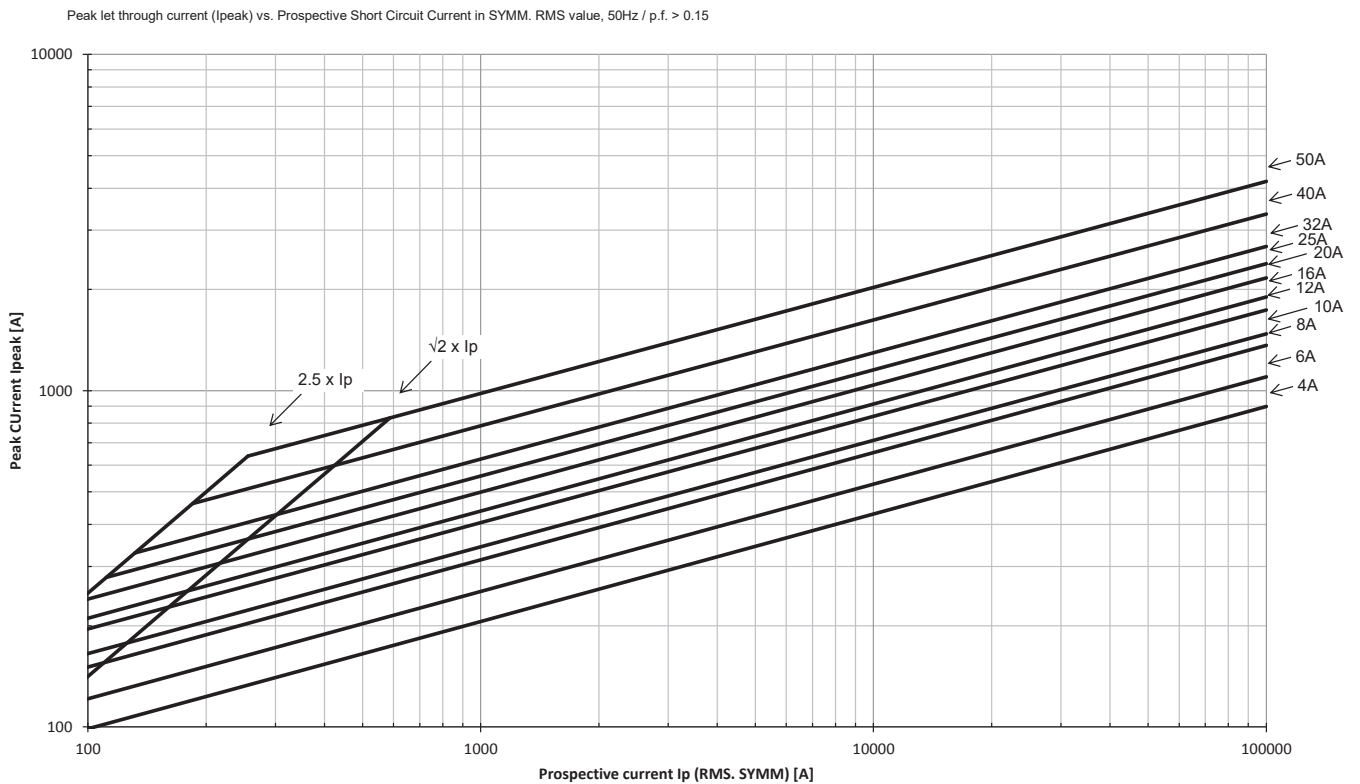

### Total clearing I<sup>2</sup>t

The total clearing I<sup>2</sup>t at rated voltage and at a power factor of 15 percent are given in the electrical characteristics. For other voltages, the clearing I<sup>2</sup>t is found by multiplying by correction factor, K, given as a function of applied working voltage, E<sub>g</sub>, (RMS).

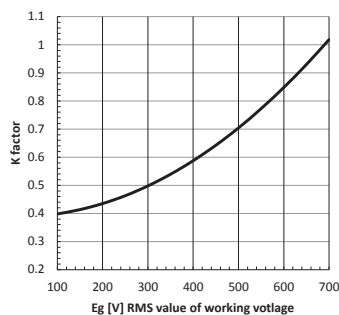

### Arc voltage

This curve gives the peak arc voltage, U<sub>L</sub>, which may appear across the fuse during its operation as a function of the applied working voltage, E<sub>g</sub>, (RMS) at a power factor of 15 percent.

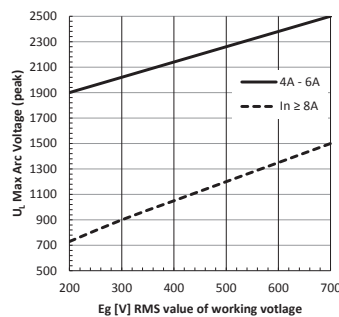

### Watts losses

Watts loss at rated current is given in the electrical characteristics. The curve allows the calculation of the watts losses at load currents lower than the rated current. The correction factor, K<sub>p</sub>, is given as a function of the RMS load current, I<sub>b</sub>, in percent of the rated current.

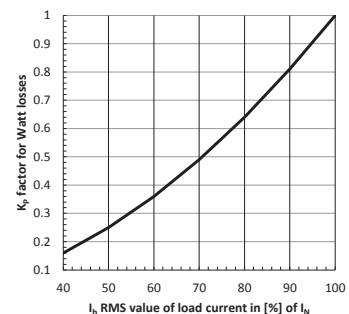

# Ferrule fuse links

## FWP - 22 x 58 mm, gR, 690 V a.c. (IEC), 20 A to 100 A

### Specifications

#### Description

The 22 x 58 mm cylindrical, class gR fuse links are used to protect AC/DC Drives and semi-conductors.

#### Technical data

- Rated voltage: 690 V a.c. (IEC)
- Rated current: 20 A to 100 A
- Breaking capacity: 200 kA a.c.
- Operating class: gR

#### Compatible fuse holder

- CH22

#### Standards / Agency information

IEC 60269-4, UL 248-13



#### Catalogue numbers

Fuse link size	Type	Rated voltage	Rated current (Amps)	I <sup>2</sup> t (A <sup>2</sup> Sec)		Watts loss (W)	Catalogue numbers
				Pre-arcing	Clearing at 690 V a.c.		
22 x 58 mm	Without indicator	690 V a.c. (IEC)	20	24	154	6.00	FWP-20G22F
			25	43	274	6.65	FWP-25G22F
			32	97	616	9.21	FWP-32G22F
			40	180	899	8.24	FWP-40G22F
			50	273	1362	11.85	FWP-50G22F
			63	516	2575	13.80	FWP-63G22F
			80	1092	5448	14.00	FWP-80G22F
			100	2065	10,300	17.70	FWP-100G22F
	With indicator	690 V a.c. (IEC)	20	24	154	6.00	FWP-20G22FI
			25	43	274	6.65	FWP-25G22FI
			32	97	616	9.21	FWP-32G22FI
			40	180	899	8.24	FWP-40G22FI
			50	273	1362	11.85	FWP-50G22FI
			63	516	2575	13.80	FWP-63G22FI
			80	1092	5448	14.00	FWP-80G22FI
			100	2065	10,300	17.70	FWP-100G22FI

#### Dimensions - mm (in)

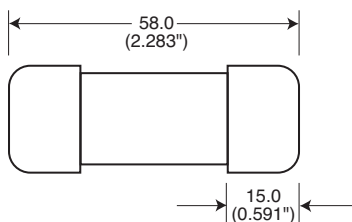

**FWP - 22 x 58 mm, gR, 690 V a.c., 20 A to 100 A**

**Time-current curve - 20 A to 100 A**

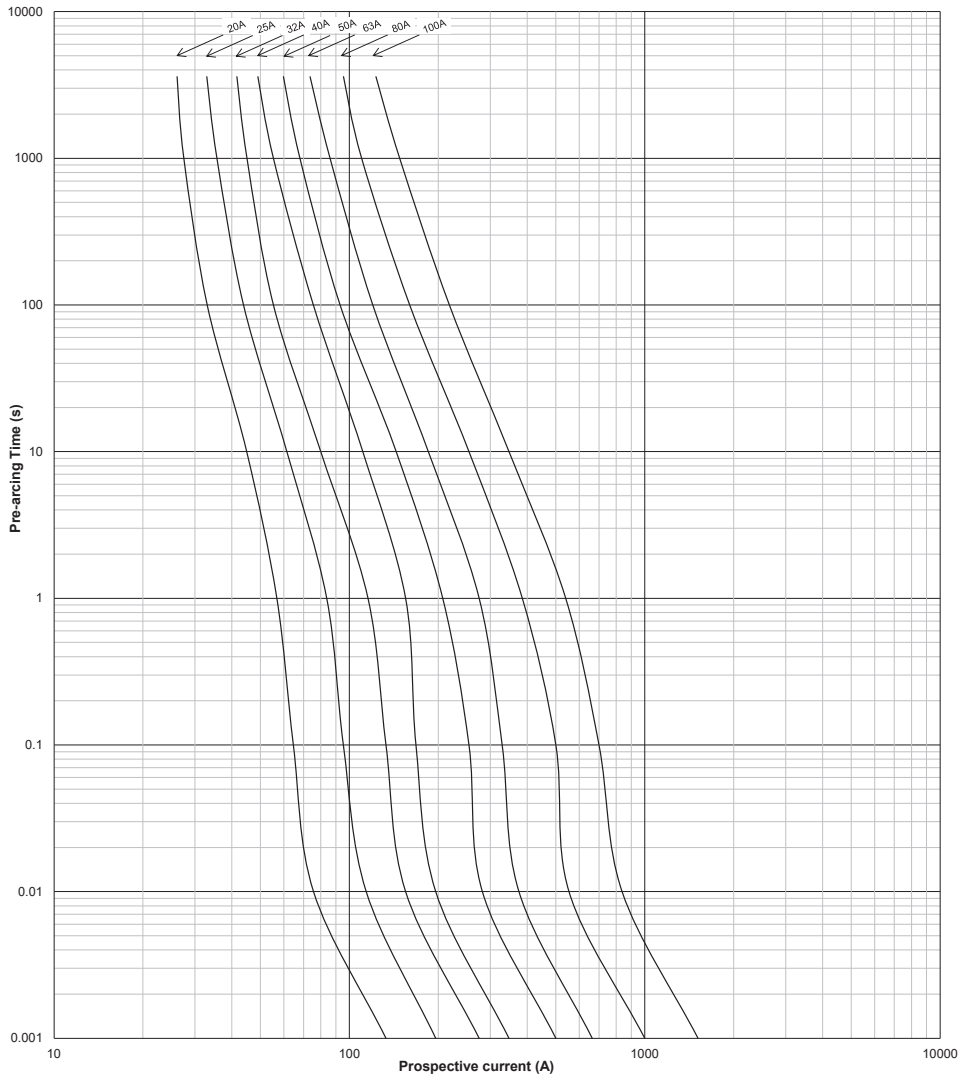

**Ambient temperature**

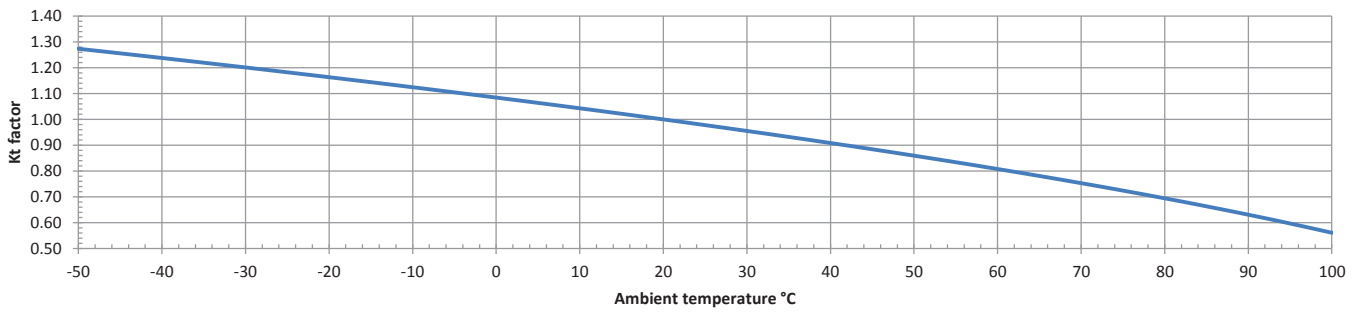

# Ferrule fuse links

## FWP - 22 x 58 mm, gR, 690 V a.c., 20 A to 100 A

### Cut-off curve - 20 A to 100 A

Peak let through current ( $I_{peak}$ ) vs. Prospective Short Circuit Current in SYMM. RMS value, 50Hz / p.f. > 0.15

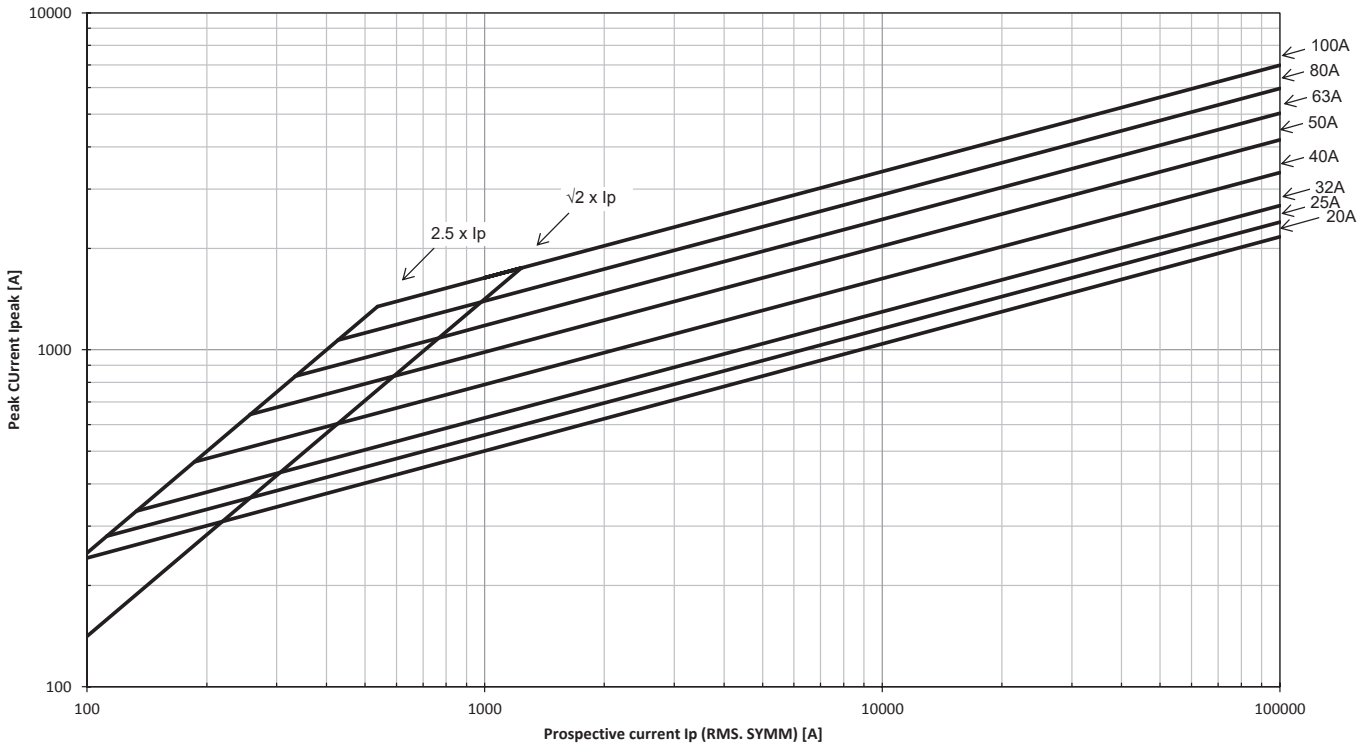

### Total clearing $I^2t$

The total clearing  $I^2t$  at rated voltage and at a power factor of 15 percent are given in the electrical characteristics. For other voltages, the clearing  $I^2t$  is found by multiplying by correction factor,  $K$ , given as a function of applied working voltage,  $E_g$ , (RMS).

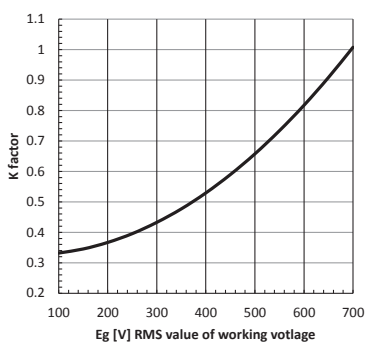

### Arc voltage

This curve gives the peak arc voltage,  $U_L$ , which may appear across the fuse during its operation as a function of the applied working voltage,  $E_g$ , (RMS) at a power factor of 15 percent.

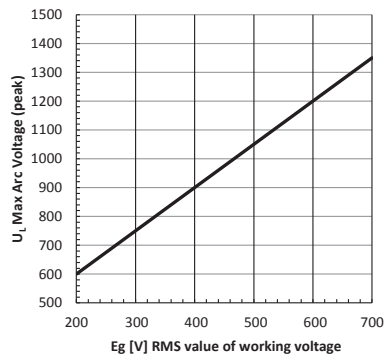

### Watts losses

Watts loss at rated current is given in the electrical characteristics. The curve allows the calculation of the watts losses at load currents lower than the rated current. The correction factor,  $K_p$ , is given as a function of the RMS load current,  $I_b$ , in percent of the rated current.

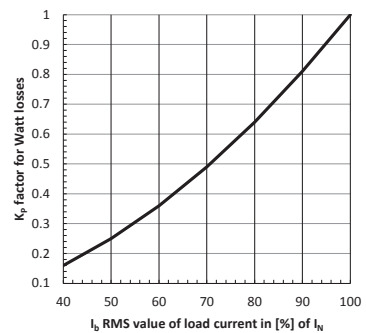

**FWP - 14 x 51 mm, 690 V a.c. (IEC), 700 V a.c. / V d.c. (UL), 1 A to 63 A**

**Specifications**

**Description**

Ferrule style high speed fuse links for the protection of DC common bus, DC drives, power converters/rectifiers and reduced rated voltage starters. Available with or without striker.

**Technical data**

- Rated voltage:
  - Without striker: see table
  - With striker: 700 V a.c. / 600 V d.c. (UL)
- Rated current:
  - Without striker: 1 A to 63 A
  - With striker: 1 A to 50 A
- Breaking capacity:
  - 200 kA RMS Sym.
  - 50 kA at 700 V d.c. (5 A to 50 A non striker version)
  - 600 V d.c. for striker version
- Operating class: aR

**Compatible modular fuse holder**

- CH14

**Standards / Agency information**

CE, UL recognised & CSA component acceptance for versions without striker only, CCC certified 5 A to 50 A



**Catalogue numbers**

Fuse link type	Fuse link size	Rated voltage	Rated current (Amps)	I <sup>2</sup> t (A <sup>2</sup> Sec)		Watts loss (W)	Catalogue numbers	
				Pre-arcing	Clearing at 700 V a.c.			
Without striker	14 x 51 mm (9/16" x 2")	700 V a.c. (UL)	1	0.04	0.41	5.7	FWP-1A14F	
			2	0.08	0.11	8.7	FWP-2A14F	
			3	0.11	0.26	2.8	FWP-3A14F	
			4	0.1	0.23	3	FWP-4A14F	
			5	2	11	1.5	FWP-5A14F	
			6	2	11	1.5	FWP-6A14F	
		700 V a.c. / 700 V d.c. (UL)	10	4	22	4	FWP-10A14F	
			15	10	70	5.5	FWP-15A14F	
			20	26	180	6.5	FWP-20A14F	
			690 V a.c. (IEC)	25	49	320	7	FWP-25A14F
				30	58	400	9	FWP-30A14F
				32	68	600	8	FWP-32A14F
			40	84	750	8	FWP-40A14F	
			50	200	1800	9	FWP-50A14F	
			63	390	2516	10	FWP-63A14F	
With striker	14 x 51 mm (9/16" x 2")	700 V a.c. / 600 V d.c. (UL)	10	4	32	2	FWP-10A14FI	
			15	7	63	4	FWP-15A14FI	
			20	26	234	4	FWP-20A14FI	
			25	42	378	4	FWP-25A14FI	
			30	52	468	6	FWP-30A14FI	
			32	68	600	8	FWP-32A14FI	
			40	84	750	8	FWP-40A14FI	
			50	200	1800	9	FWP-50A14FI	

Data sheets: 720025, 5781724 fuses without striker; 5785566 fuses with striker, 5785626 (63 A)

# Ferrule fuse links

**FWP - 14 x 51 mm, 690 V a.c. (IEC), 700 V a.c. / V d.c. (UL), 1 A to 50 A**

## Dimensions - mm (in)

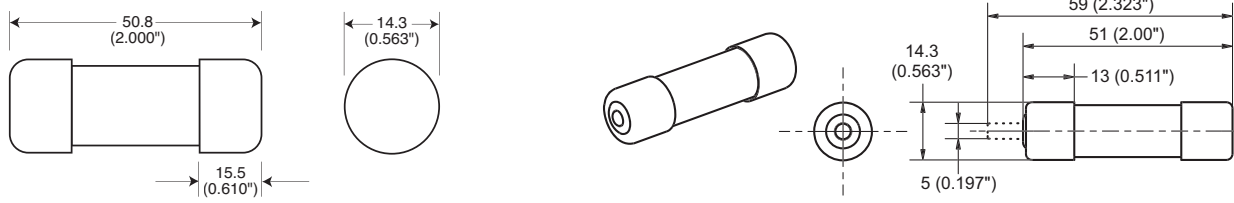

Without striker

With striker

## Time-current curve - 1 A to 50 A

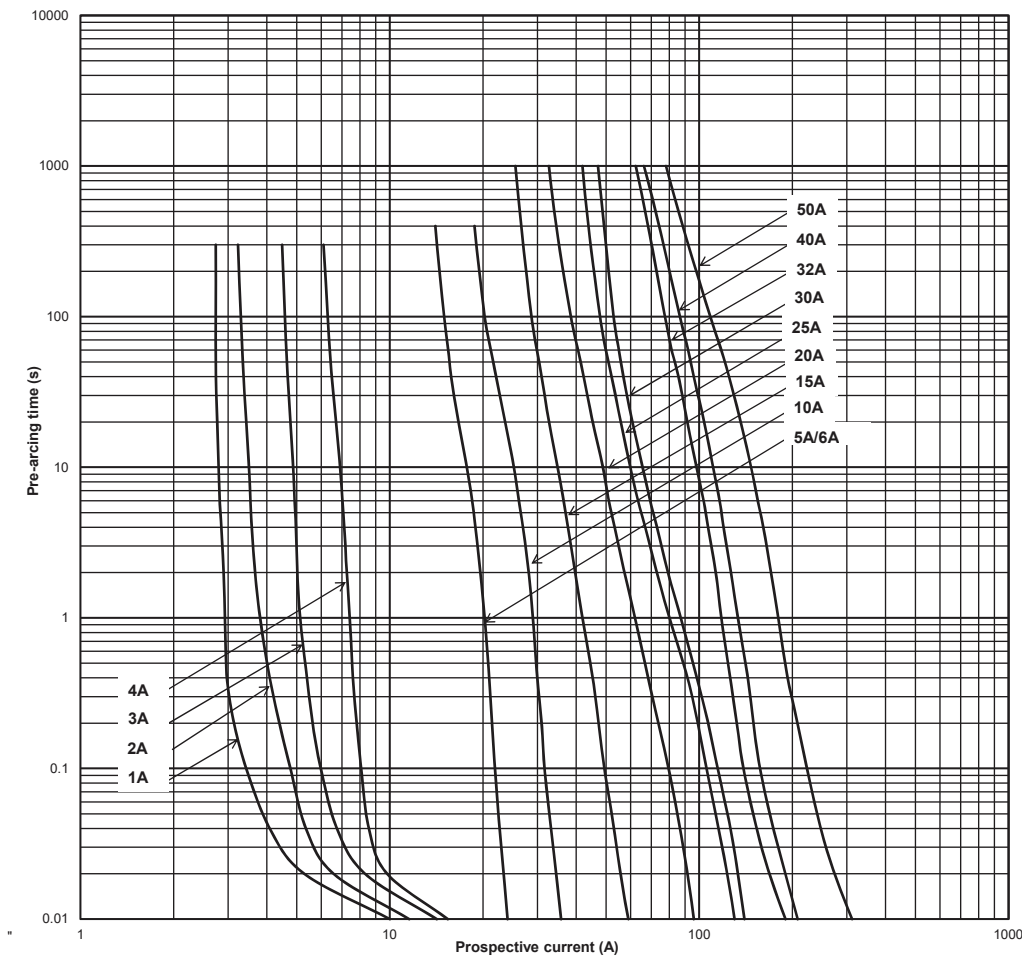

Data sheets: 720025, 5781724 fuses without striker; 5785566 fuses with striker, 5785626 (63 A)



**FWP - 14 x 51 mm, 690 V a.c. (IEC), 700 V a.c. / V d.c. (UL), 1 A to 50 A**

**Time-current curve - 63 A**

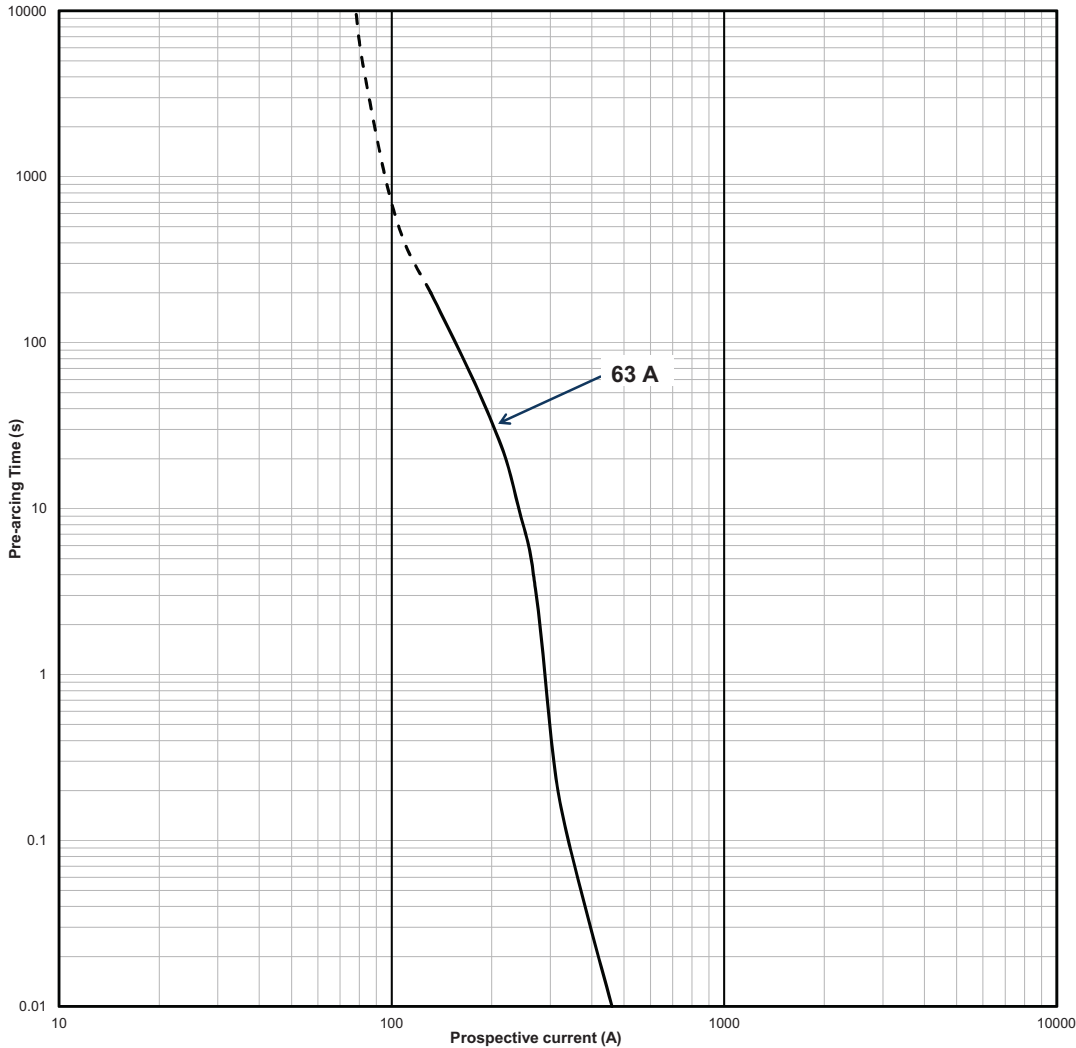

**Total clearing I<sup>2</sup>t**

The total clearing I<sup>2</sup>t at rated voltage and at a power factor of 15 percent are given in the electrical characteristics. For other voltages, the clearing I<sup>2</sup>t is found by multiplying by correction factor, K, given as a function of applied working voltage, E<sub>g</sub>, (RMS).

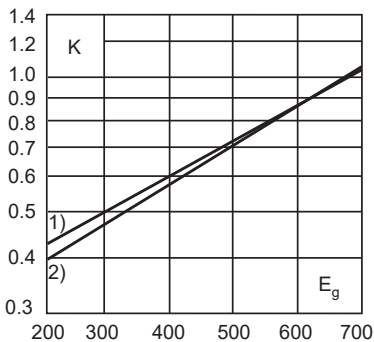

**Arc voltage**

This curve gives the peak arc voltage, U<sub>L</sub>, which may appear across the fuse during its operation as a function of the applied working voltage, E<sub>g</sub>, (RMS) at a power factor of 15 percent.

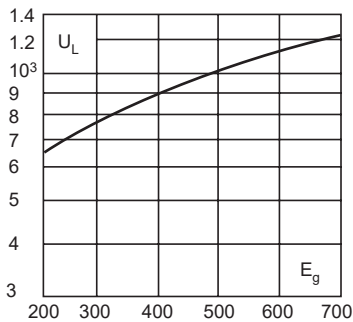

**Watts losses**

Watts loss at rated current is given in the electrical characteristics. The curve allows the calculation of the watts losses at load currents lower than the rated current. The correction factor, K<sub>p</sub>, is given as a function of the RMS load current, I<sub>b</sub>, in percent of the rated current.

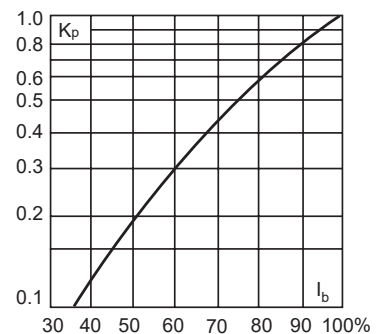

Data sheets: 720025, 5781724 fuses without striker; 5785566 fuses with striker

# Ferrule fuse links

## FWP - 22 x 58 mm, 700 V a.c. / V d.c. (UL), 20 A to 100 A

### Specifications

#### Description

Ferrule style high speed fuse links for the protection of DC common bus, DC drives, power converters/rectifiers and reduced rated voltage starters. Available with or without striker.

#### Technical data

- Rated voltage: 700 V a.c. / V d.c. (UL)
- Rated current: 20 A to 100 A
- Breaking capacity:
  - 200 kA RMS Sym.
  - 50 kA at 700 V d.c., t/c 5 ms
- Operating Class: aR

#### Compatible modular fuse holder

- CH22

#### Standards / Agency information

CE, UL Recognised, CSA Component Acceptance for versions without striker only, CCC certified



#### Catalogue numbers

Fuse link type	Fuse link size	Rated voltage	Rated current (Amps)	I <sup>2</sup> t (A <sup>2</sup> Sec)		Watts loss (W)	Catalogue numbers
				Pre-arcing	Clearing at 700 V a.c.		
Without striker	22 x 58 mm (7/8" x 2 9/32")	700 V a.c./ 700 V d.c. (UL)	20	23	330	5	FWP-20A22F
			25	37	530	6	FWP-25A22F
			32	55	780	8	FWP-32A22F
			40	68	960	12	FWP-40A22F
			50	155	2200	12.5	FWP-50A22F
			63	280	4000	15	FWP-63A22F
			80	550	7800	15	FWP-80A22F
			100	1100	15,600	16.5	FWP-100A22F
With striker	22 x 58 mm (7/8" x 2 9/32")	700 V a.c./ 700 V d.c. (UL)	20	19	260	5	FWP-20A22FI
			25	34	410	6	FWP-25A22FI
			32	53.5	605	8	FWP-32A22FI
			40	68	750	9	FWP-40A22FI
			50	135	1600	9.5	FWP-50A22FI
			63	280	3080	11	FWP-63A22FI
			80	600	6600	13.5	FWP-80A22FI
			100	1100	12,500	16	FWP-100A22FI

#### Dimensions - mm (in), without striker

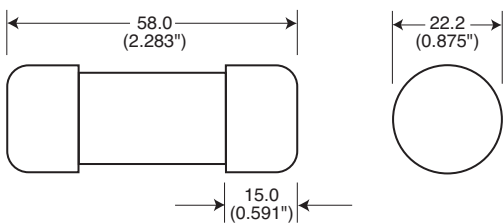

#### Dimensions - mm (in), with striker

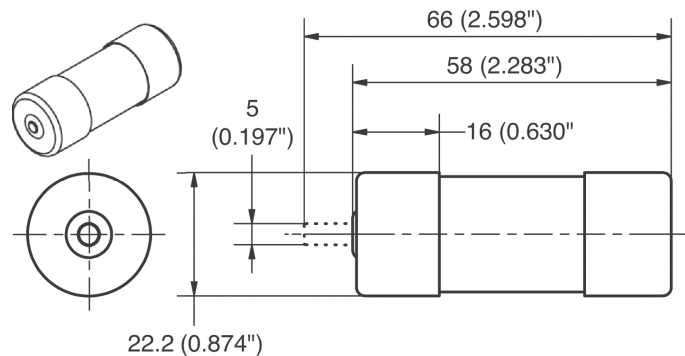

Data sheets: 720026, 5781723

**FWP - 22 x 58 mm, 700 V a.c. / V d.c. (UL), 20 A to 100 A**

**Time-current curve - 20 A to 100 A**

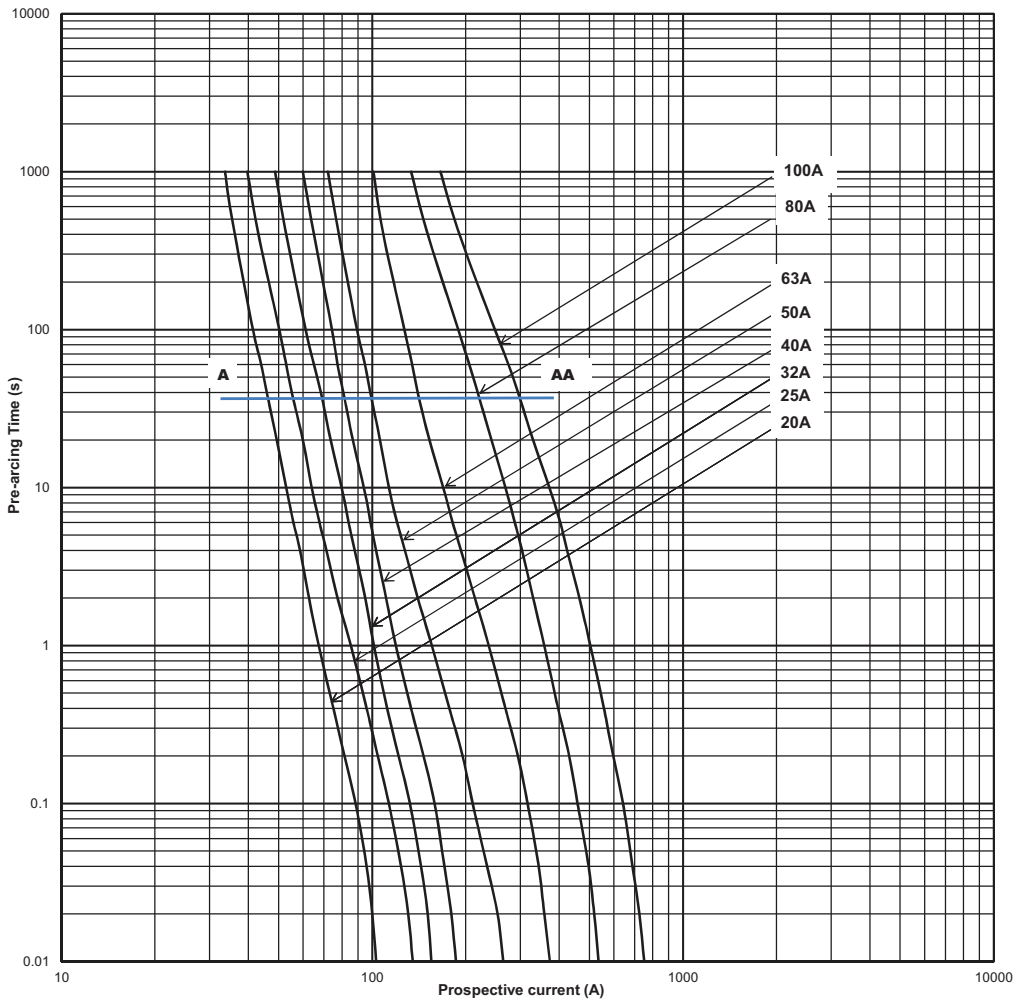

**Total clearing I<sup>2</sup>t**

The total clearing I<sup>2</sup>t at rated voltage and at a power factor of 15 percent are given in the electrical characteristics. For other voltages, the clearing I<sup>2</sup>t is found by multiplying by correction factor, K, given as a function of applied working voltage, E<sub>g</sub>, (RMS).

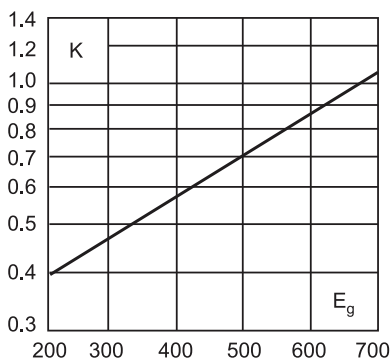

**Arc voltage**

This curve gives the peak arc voltage, U<sub>L</sub>, which may appear across the fuse during its operation as a function of the applied working voltage, E<sub>g</sub>, (RMS) at a power factor of 15 percent.

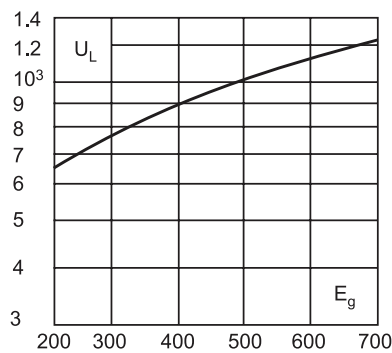

**Watts losses**

Watts loss at rated current is given in the electrical characteristics. The curve allows the calculation of the watts losses at load currents lower than the rated current. The correction factor, K<sub>p</sub>, is given as a function of the RMS load current, I<sub>b</sub>, in percent of the rated current.

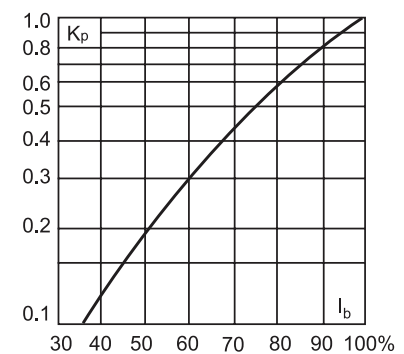

Data sheets: 720026, 5781723

# Ferrule fuse links

## FWK - 20 x 127 mm and 25 x 146 mm, 750 V d.c. (IEC), 5 A to 60 A

### Specifications

#### Description

Ferrule style high speed fuse links for the protection of DC common bus, DC drives, power converters/rectifiers and reduced rated voltage starters.

#### Technical Data

- Rated voltage: 750 V d.c. (IEC)
- Rated current:
  - 5 A to 30 A (20 x 127 mm)
  - 35 A to 60 A (25 x 146 mm)
- Breaking capacity: 50 kA at 750 V d.c., L/R 10-15ms
- Operating class: gG

#### Standards / Agency information:

CE



#### Catalogue numbers

Fuse link size	Rated voltage	I <sup>2</sup> t (A <sup>2</sup> Sec)				Catalogue numbers
		Rated current (Amps)	Pre-arcing	Clearing at 750 V d.c.	Watts loss (W)	
20 x 127 mm (13/16" x 5")	750 V d.c. (IEC)	5	8.5	16	6.7	FWK-5A20F
		8	50	100	8.8	FWK-8A20F
		10	95	200	8.5	FWK-10A20F
		15	100	240	5	FWK-15A20F
		20	125	315	7.8	FWK-20A20F
		25	400	1100	6.5	FWK-25A20F
		30	800	2600	6.5	FWK-30A20F
25 x 146 mm (1" x 5 3/4")	750 V d.c. (IEC)	35	1300	4600	6	FWK-35A25F
		40	1600	5300	6.8	FWK-40A25F
		50	3100	12,000	7.3	FWK-50A25F
		60	5900	24,000	7.7	FWK-60A25F

#### Dimensions - mm (in), 20 x 127 mm, 5 A to 30 A

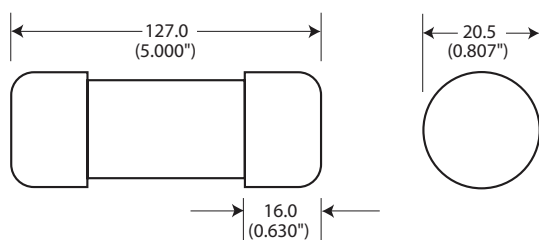

#### Dimensions - mm (in), 25 x 146 mm, 35 A to 60 A

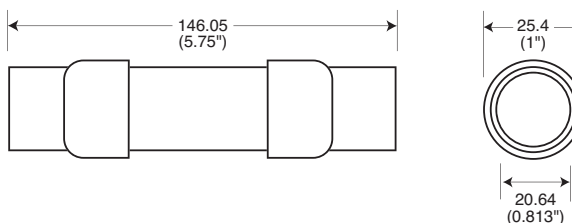

**FWK - 20 x 127 mm and 25 x 146 mm, 750 V d.c. (IEC), 5 A to 60 A**

Time-current curve - 20 A to 100 A

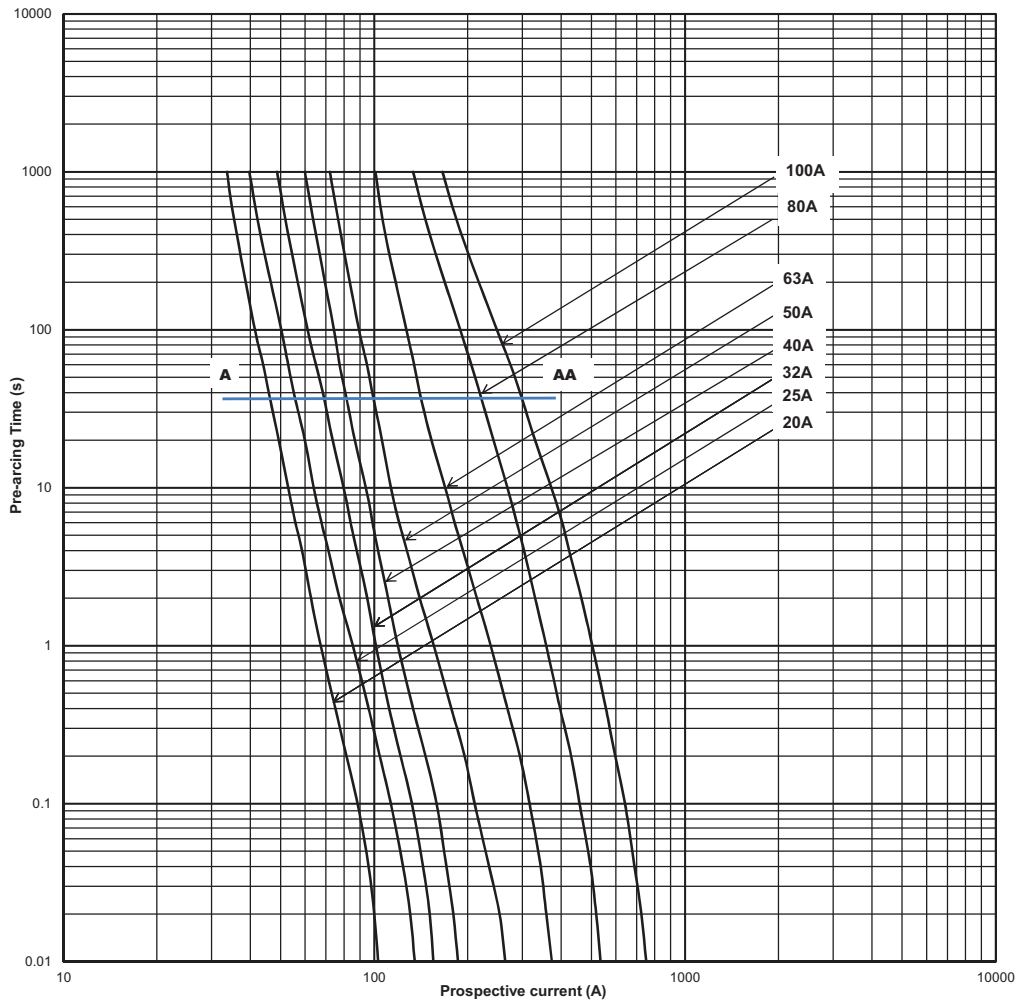

# Ferrule fuse links

## FWJ - 14 x 67 mm, 1000 V a.c. / 800 V d.c. (UL), 20 A to 30 A

### Specifications

#### Description

Ferrule style high speed fuse links for the protection of DC common bus, DC drives, power converters/rectifiers and reduced rated voltage starters.

#### Technical data

- Rated voltage: 1000 V a.c. / 800 V d.c.
- Rated current: 20 A to 30 A
- Breaking capacity:
  - 25kA RMS Sym
  - 50 kA at 800 V d.c.
- Operating class: aR

#### Standards / Agency information

CE, UL Recognised



### Catalogue numbers

Fuse link size	Rated voltage	Rated current (Amps)	I <sup>2</sup> t (A <sup>2</sup> Sec)		Watts loss (W)	Catalogue numbers
			Pre-arcing	Clearing at 1000 V a.c.		
14 x 67 mm ( <sup>9</sup> / <sub>16</sub> " x 2 <sup>5</sup> / <sub>8</sub> " )	1000 V a.c./ 800 V d.c. (UL)	20	25	220	9	FWJ-20A14F
		25	33	350	11	FWJ-25A14F
		30	52	450	14	FWJ-30A14F

### Dimensions (mm)

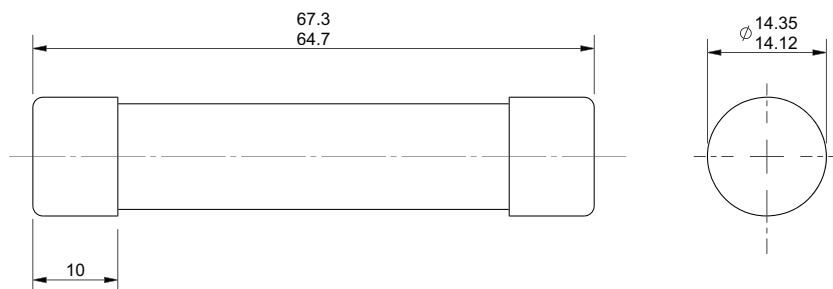

**FWJ - 14 x 67 mm, 1000 V a.c. / 800 V d.c. (UL), 20 A to 30 A**

Time-current curve - 20 A to 30 A

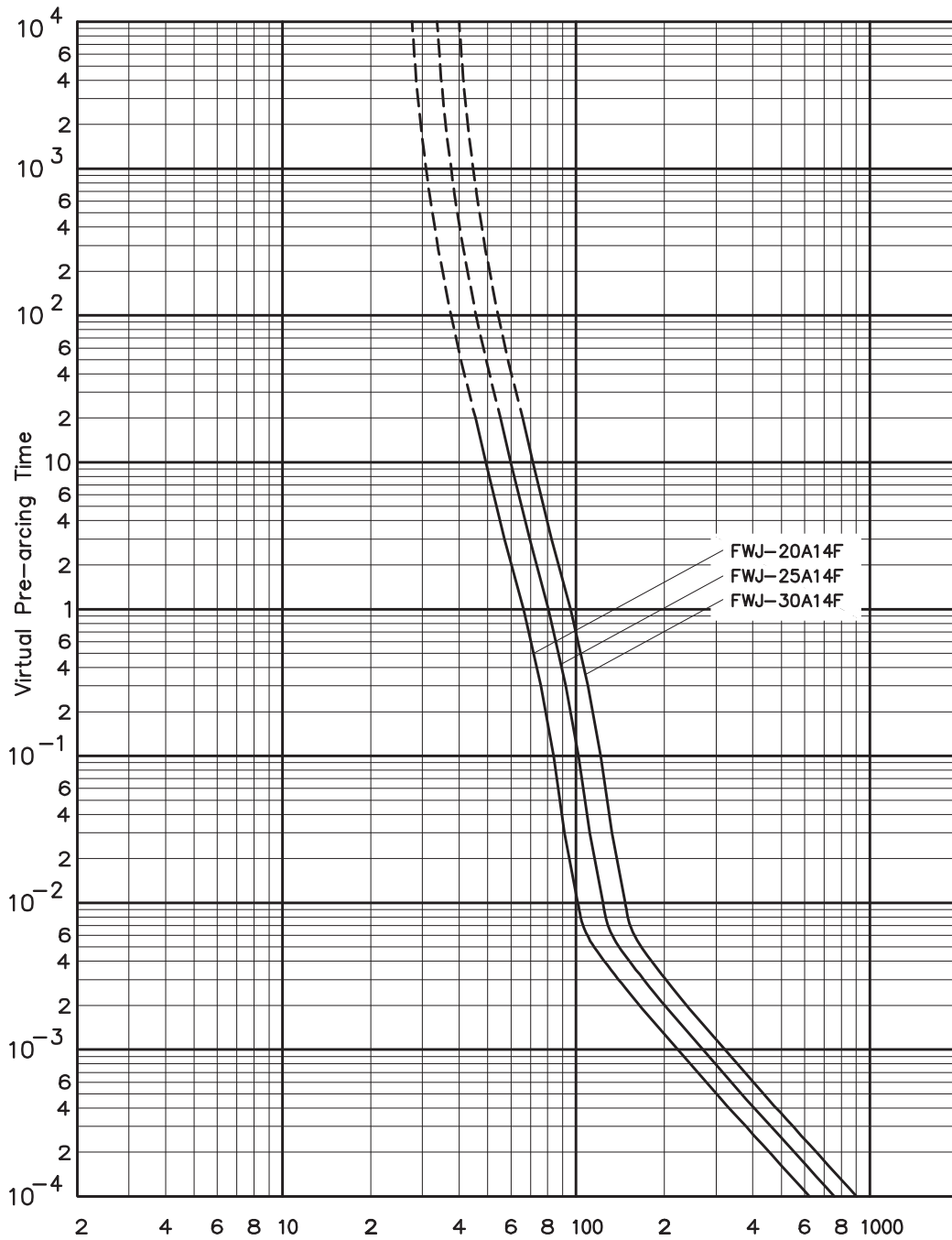

# Ferrule fuse links

## FWL - 20 x 127 mm, 1200 V a.c. / 1000 V d.c. (IEC), 20 A to 30 A

### Specifications

#### Description

Ferrule style high speed fuse links for the protection of DC common bus, DC drives, power converters/rectifiers and reduced rated voltage starters. Available with indicator.

#### Technical data

- Rated voltage: 1200 V a.c. / 1000 V d.c. (IEC)
- Rated current: 20 A, 25 A and 30 A
- Breaking capacity:
  - 50 kA RMS Sym
  - 50 kA at 1000 V d.c.
- Operating Class: gR

#### Standards / Agency information

CE

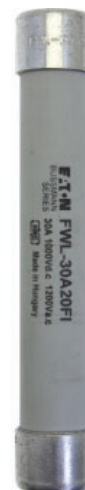

#### Catalogue numbers

Fuse link size	Rated voltage	Rated current (Amps)	I <sup>2</sup> t (A <sup>2</sup> Sec)		Watts loss (W)	Catalogue numbers	
			Pre-arcing	Clearing at 1000 V a.c.		Without indicator	With indicator
20 x 127 mm (13/16" x 5")	1200 V a.c./ 1000 V d.c. (IEC)	20	675	1550	5.9	FWL-20A20F	FWL-20A20FI
		25	1200	2760	6.5	FWL-25A20F	FWL-25A20FI
		30	1850	4300	7.5	FWL-30A20F	FWL-30A20FI

#### Dimensions (mm)

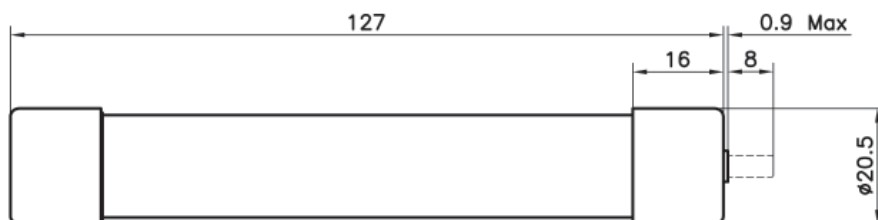



**FWL - 20 x 127 mm, 1200 V a.c. / 1000 V d.c. (IEC), 20 A to 30 A**

Time-current curve - 20 A to 30 A

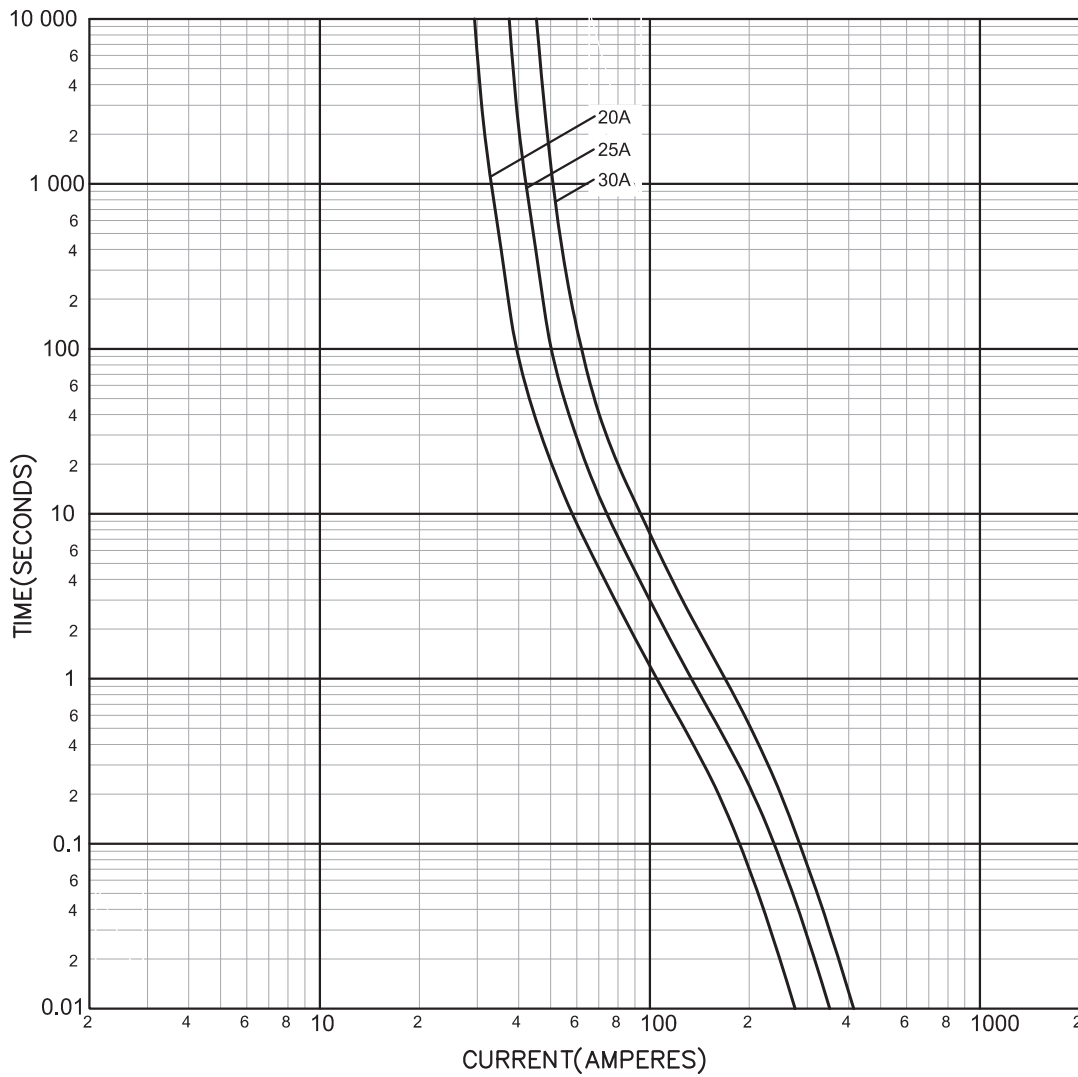

# Ferrule fuse links

## FWS - 20 x 127 mm, 1400 - 2000 V a.c. / 1000 V d.c. (IEC), 2 A to 15 A

### Specifications

#### Description

Ferrule style high speed fuse links for the protection of DC common bus, DC drives, power converters/rectifiers and reduced rated voltage starters. Available with indicator.

#### Technical Data

- Rated voltage:
  - 2000 V a.c. / 1000 V d.c. (IEC, 2 A to 8 A)
  - 1400 V a.c. / 1000 V d.c. (IEC, 10 A to 15 A)
- Rated current: 2 A to 15 A
- Breaking capacity:
  - 50 kA RMS Sym.
  - 50 kA at 1000 V d.c. (2 A to 10 A only)
- Operating class: gR

#### Standards/Agency Information

CE

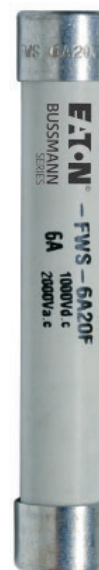

#### Catalogue numbers

Fuse link size	Rated voltage	Rated current (Amps)	$I^2t$ (A <sup>2</sup> Sec)			Catalogue numbers	
			Pre-arcing	Clearing at 1000 V a.c.	Watts loss (W)	Without indicator	With indicator
20 x 127 mm (13/16" x 5")	2000 V a.c./2000 V d.c.(IEC)	2	0.8	2.4	4.4	FWS-2A20F	FWS-2A20FI
	2000 V a.c./1000 V d.c.(IEC)	6	27	81	6.7	FWS-6A20F	FWS-6A20FI
		8	64	192	7.6	FWS-8A20F	FWS-8A20FI
		10	118	277	3	FWS-10A20F	FWS-10A20FI
	1400 V a.c./ 1000 V d.c.(IEC)	12	170	380	3.4	FWS-12A20F	FWS-12A20FI
15		209	500	5	FWS-15A20F	FWS-15A20FI	

#### Dimensions (mm)

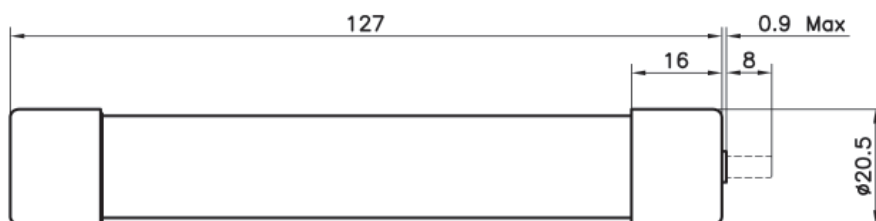

**FWS - 20 x 127 mm, 1400 - 2000 V a.c. / 1000 V d.c. (IEC), 2 A to 15 A**

Time-current curve - 2 A to 15 A

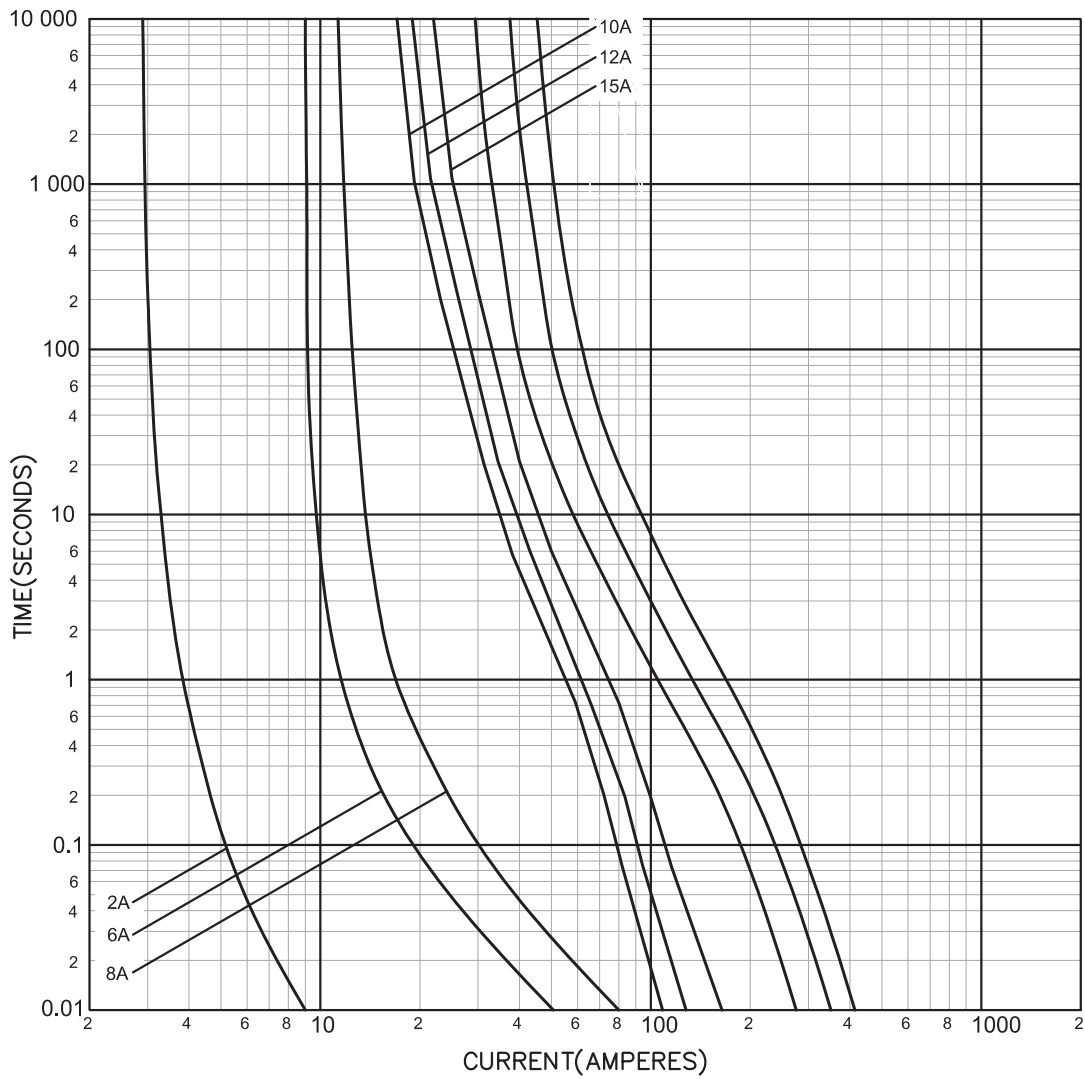

# Square body fuse links

**170M** - Sizes 000 and 00, DIN 43653, 690 V a.c. (IEC), 700 V a.c. / V d.c. (UL), 10 A to 400 A

## Specifications

### Description

Square body DIN 43653 bolted tags high speed fuse links, for the protection of DC common bus, DC drives, power converters/rectifiers and reduced rated voltage starters.

### Technical data

- Rated voltage:
  - 690 V a.c. (IEC)
  - 700 V a.c. (UL, size 000; size 00 100 A to 400 A)
  - 700 V d.c. (UL, size 000)
- Rated current: 10 A to 400 A
- Breaking capacity:
  - 200 kA RMS Sym
  - 50 kA at 700 V d.c. (size 000 only)
- Operating class
  - gR - size 000 (10 A to 63 A), size 00 (25 A to 80 A)
  - aR - size 000 (>63 A), size 00 (>80 A)



### Standards/Agency Information

CE, Designed and tested to IEC 60269 part 4. UL Recognised/CSA Component Acceptance on Size 000. CCC approved

### Dimensions (mm)

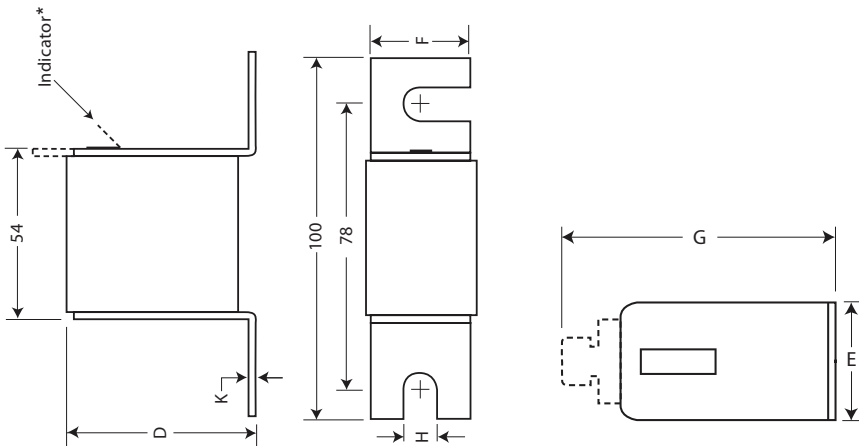

\* Indication for Size 00 fuses is a red pin.

The dotted line illustrates the Type T indicator fuse link.

### Type -U/80, -/80, -TN/80

Size	D	E	F	G	H	K
000	40	21	20	51	8	2
00	51	30	28	67	10	2

Data sheets: 170K6310 (Size 000), 170K6312 (Size 00)

## 170M - Sizes 000 and 00, DIN 43653, 690 V a.c. (IEC), 700 V a.c. / V d.c. (UL), 10 A to 400 A

### Catalogue numbers

Fuse link body size	Rated voltage	Rated current (Amps)	Pt (A² Sec)			Operating class	Catalogue numbers			
			Pre-Arcing	Clearing at 660 V a.c.	Watts loss (W)		-U/80 Without indicator	-/80 Visual indicator	-TN/80 Type T indicator for micro	
000	690 V a.c. (IEC)  700 V a.c. / V d.c. (UL)	10	3.8	25.5	3	gR	170M1308	170M1358	170M1408	
		16	7.2	48	5.5		170M1309	170M1359	170M1409	
		20	11.5	78	7		170M1310	170M1360	170M1410	
		25	19	130	9		170M1311	170M1361	170M1411	
		32	40	270	10		170M1312	170M1362	170M1412	
		40	69	460	12		170M1313	170M1363	170M1413	
		50	115	770	15		170M1314	170M1364	170M1414	
		63	215	1450	16		170M1315	170M1365	170M1415	
		80	380	2550	19		aR	170M1316	170M1366	170M1416
		100	695	4650	24			170M1317	170M1367	170M1417
		125	1250	8500	28	170M1318		170M1368	170M1418	
		160	2350	16,000	32	170M1319		170M1369	170M1419	
		200	4200	28,000	37	170M1320		170M1370	170M1420	
		250	7750	51,500	42	170M1321	170M1371	170M1421		
		315	12,000	80,500	53	170M1322	170M1372	170M1422		
00	690 V a.c. (IEC)	25	19	130	6	gR		170M2608	170M2658	
		32	28.5	195	7		170M2609	170M2659		
		40	50	360	9		170M2610	170M2660		
		50	95	640	10		170M2611	170M2661		
		63	170	1200	12		170M2612	170M2662		
		80	310	2100	15		170M2613	170M2663		
00	690 V a.c. (IEC)  700 V a.c. (UL)	100	620	4150	20	aR		170M2614	170M2664	
		125	1000	6950	25		170M2615	170M2665		
		160	1900	13,000	30		170M2616	170M2666		
		200	3400	23,000	35		170M2617	170M2667		
		250	6250	42,000	45		170M2618	170M2668		
		315	10,000	68,500	55		170M2619	170M2669		
		350	13,500	91,500	60		170M2620	170M2670		
		400	18,000	125,000	70		170M2621	170M2671		

# Square body fuse links

**170M** - Sizes 000 and 00, DIN 43653, 690 V a.c. (IEC), 700 V a.c. / V d.c. (UL), 10 A to 400 A

Time-current curve - Size 000 - 10 A to 315 A

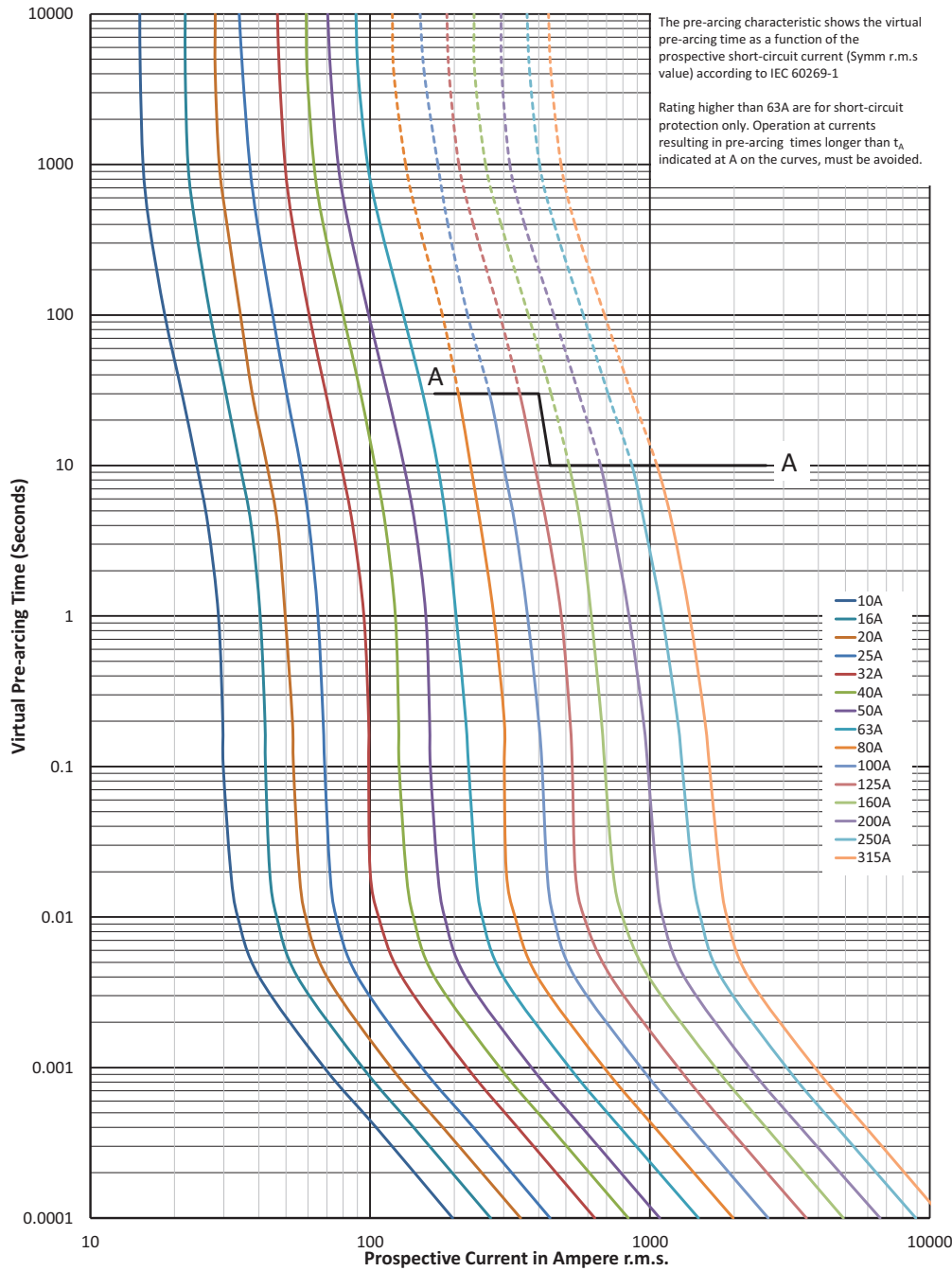

$K_b = 1$     $N = 1.6$

**170M** - Sizes 000 and 00, DIN 43653, 690 V a.c. (IEC), 700 V a.c. / V d.c. (UL), 10 A to 400 A

Cut-off curve - Size 000 - 10 A to 315 A

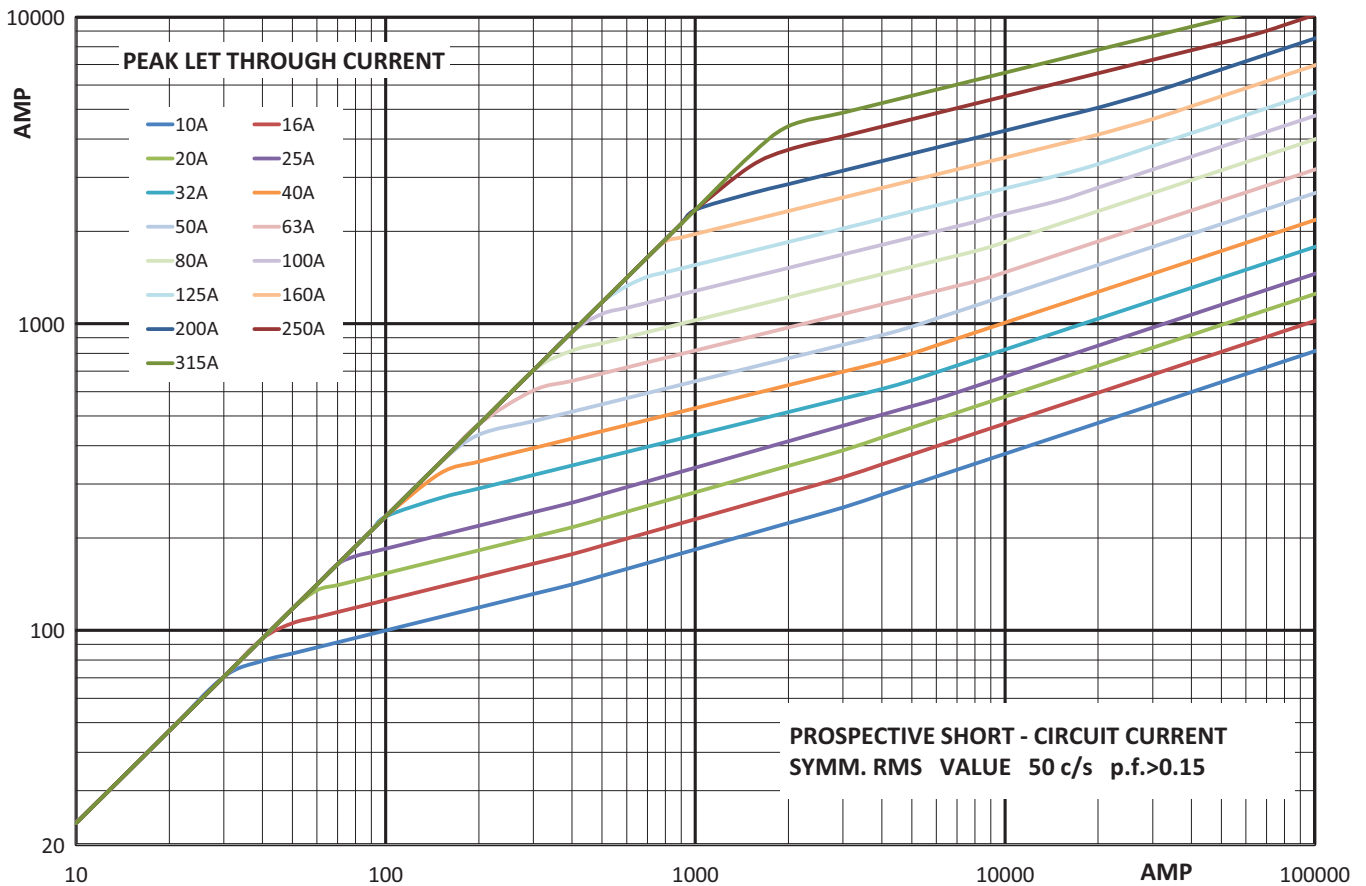

**Total clearing  $I^2t$**

The total clearing  $I^2t$  at rated voltage and at a power factor of 15 percent are given in the electrical characteristics. For other voltages, the clearing  $I^2t$  is found by multiplying by correction factor,  $K$ , given as a function of applied working voltage,  $E_g$ , (RMS).

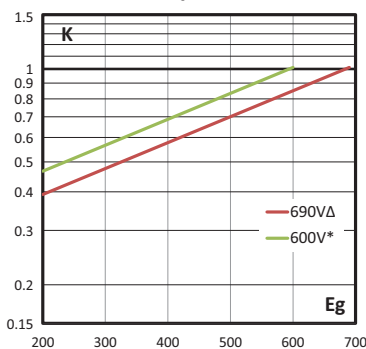

**Arc voltage**

This curve gives the peak arc voltage,  $U_L$ , which may appear across the fuse during its operation as a function of the applied working voltage,  $E_g$ , (RMS) at a power factor of 15 percent.

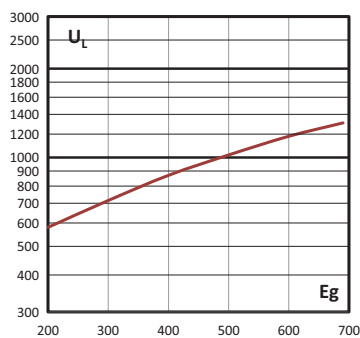

**Watts losses**

Watts loss at rated current is given in the electrical characteristics. The curve allows the calculation of the watts losses at load currents lower than the rated current. The correction factor,  $K_p$ , is given as a function of the RMS load current,  $I_b$ , in percent of the rated current.

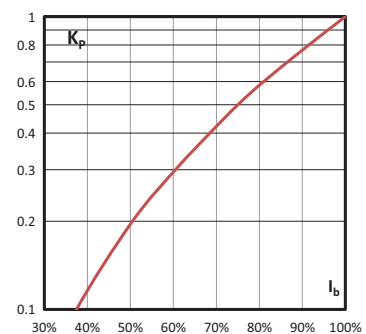

# Square body fuse links

**170M** - Sizes 000 and 00, DIN 43653, 690 V a.c. (IEC), 700 V a.c. / V d.c. (UL), 10 A to 400 A

Time-current curve - Size 00, 25 A to 400 A

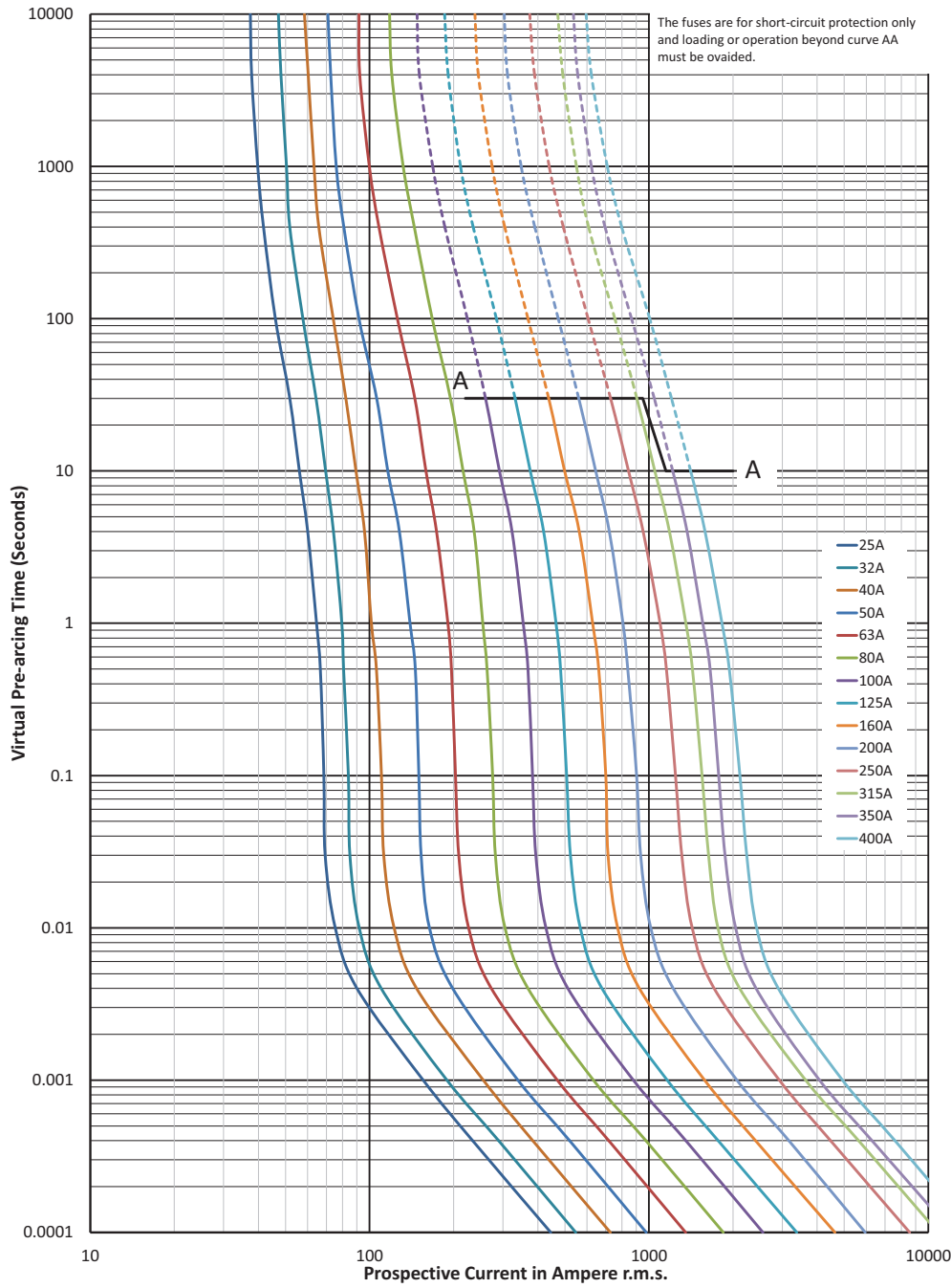

$K_b = 1$   $N = 1.5$

Data sheets: 170K6310 (Size 000), 170K6312 (Size 00)



## 170M - Sizes 000 and 00, DIN 43653, 690 V a.c. (IEC), 700 V a.c. / V d.c. (UL), 10 A to 400 A

Cut-off curve- Size 00 , 25 A to 400 A

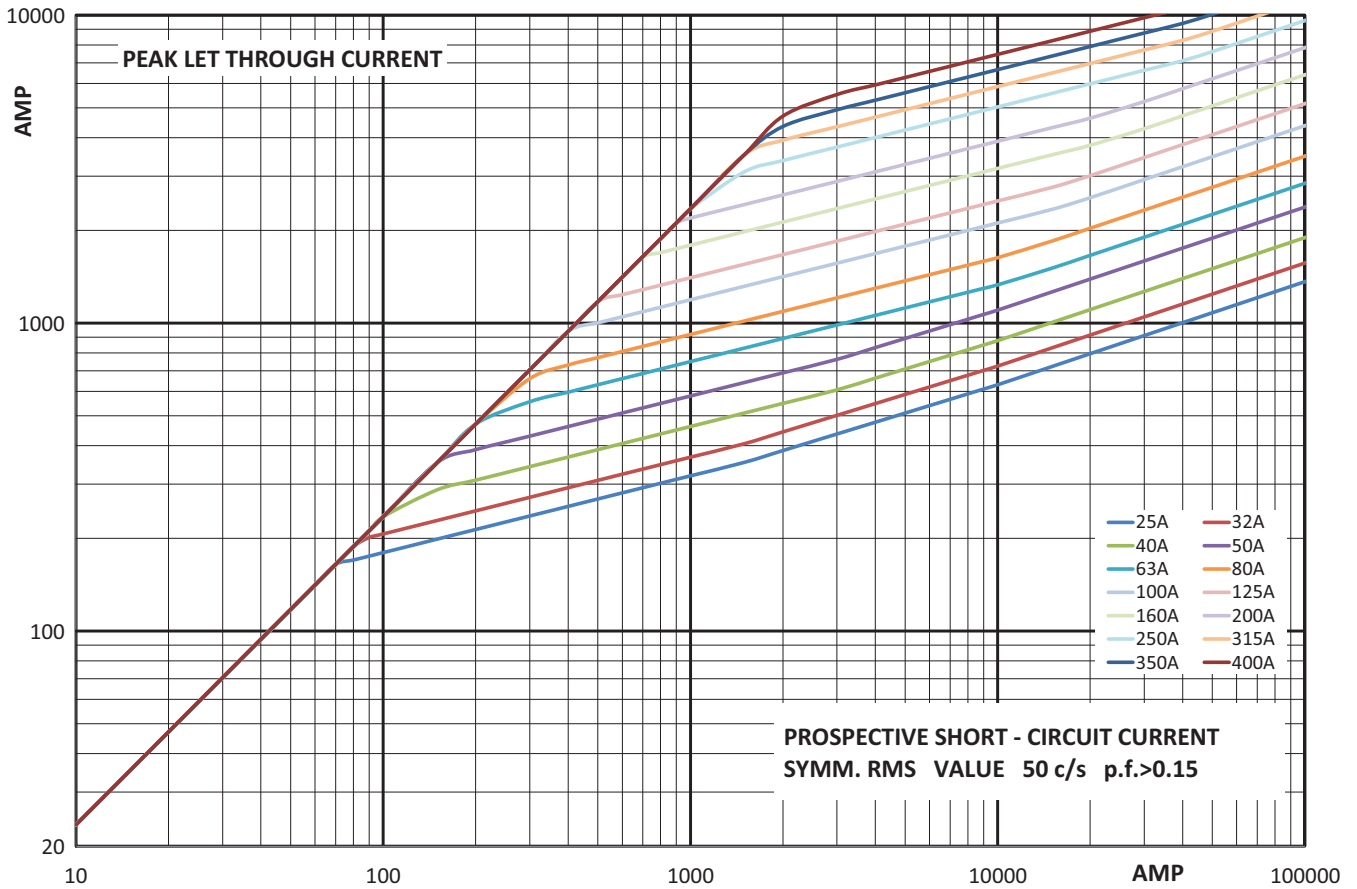

### Total clearing $I^2t$

The total clearing  $I^2t$  at rated voltage and at a power factor of 15 percent are given in the electrical characteristics. For other voltages, the clearing  $I^2t$  is found by multiplying by correction factor,  $K$ , given as a function of applied working voltage,  $E_g$ , (RMS).

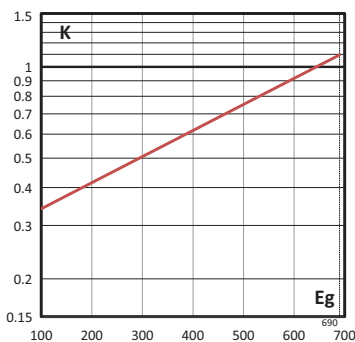

### Arc voltage

This curve gives the peak arc voltage,  $U_L$ , which may appear across the fuse during its operation as a function of the applied working voltage,  $E_g$ , (RMS) at a power factor of 15 percent.

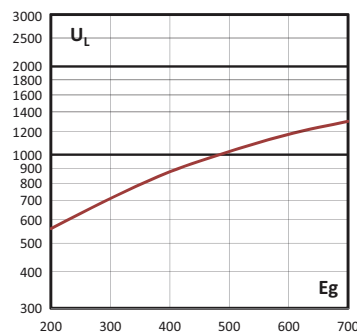

### Watts losses

Watts loss at rated current is given in the electrical characteristics. The curve allows the calculation of the watts losses at load currents lower than the rated current. The correction factor,  $K_p$ , is given as a function of the RMS load current,  $I_b$ , in percent of the rated current.

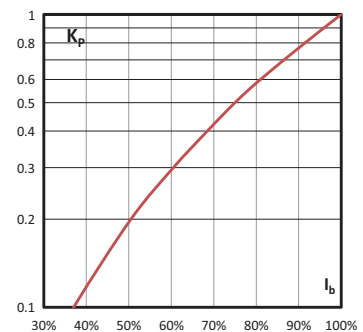

# Square body fuse links

170M - Sizes 1\* to 3, DIN 43653, 690 V a.c. (IEC), 700 V a.c. (UL), 40 A to 2000 A

## Specifications

### Description

Square body DIN 43653 bolted tags high speed fuse links, for the protection of DC common bus, DC drives, power converters/rectifiers and reduced rated voltage starters.

### Technical data

- Rated voltage:
  - 690 V a.c. (IEC)
  - 700 V a.c. (UL)
- Rated current: 40 A to 2000 A
- Breaking capacity: 200 kA RMS Sym
- Operating class: aR



### Standards / Agency information

CE, Designed and tested to IEC60269 Part 4. Consult Eaton for UL Recognition/CSA Component Acceptance status. CCC except where noted.

### Dimensions (mm)

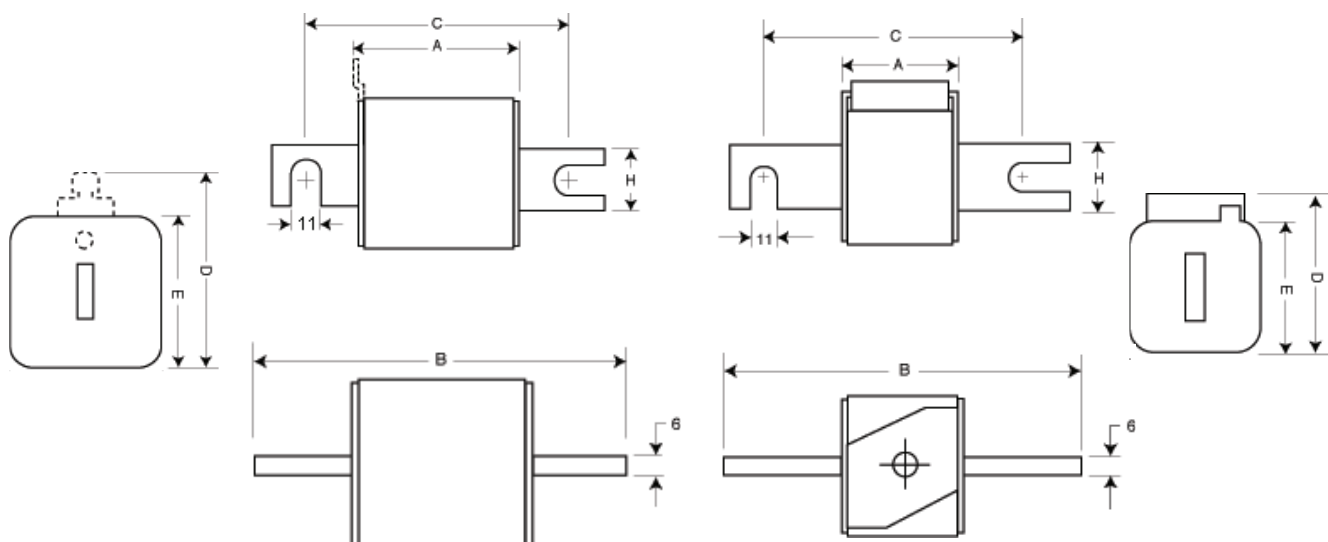

#### Type -/80, -TN/80, -/110, -TN/110

Size	A	B	B <sup>1</sup>	C	C <sup>1</sup>	D <sup>2</sup>	E	H
1*	50	104	134	78	108	58	45	22
1	50	108	138	78	108	66	53	25
2	50	108	138	78	108	75	61	25
3	51	109	139	78	108	90	76	30

#### Type -KN/80, -KN/110

Size	A	B	B <sup>3</sup>	C	C <sup>3</sup>	D	E	H
1*	50	104	134	78	108	59	45	22
1	50	108	138	78	108	69	53	25
2	50	108	138	78	108	77	61	25
3	51	109	139	78	108	92	76	30

<sup>1</sup> Valid for fuse links type -/110, -TN/110.

<sup>2</sup> Valid for Fuse type -TN/80 and -TN/110.

1mm = 0.0394"

<sup>3</sup> Valid for fuse links type -KN/110.

1mm = 0.0394"

170M - Sizes 1\* to 3, DIN 43653, 690 V a.c. (IEC), 700 V a.c. (UL), 40 A to 2000 A

Catalogue numbers

Fuse link body size	Rated voltage	I <sup>2</sup> t (A <sup>2</sup> Sec)				Catalogue numbers							
		Rated current (Amps)	Pre-arcing	Clearing at 660 V a.c.	Watts loss (W)	-/80 Visual indicator	-TN/80 Type T indicator for micro	-KN/80 Type K indicator for micro	-/110 Visual indicator	-TN/110 Type T indicator for micro	-KN/110 Type K indicator for micro		
1*	690 V a.c. (IEC) 700 V a.c. (UL)	40	40	270	9	170M3008	170M3058	170M3108	170M3158	170M3208	170M3258		
		50	77	515	11	170M3009	170M3059	170M3109	170M3159	170M3209	170M3259		
		63	115	770	14	170M3010	170M3060	170M3110	170M3160	170M3210	170M3260		
		80	185	1250	18	170M3011	170M3061	170M3111	170M3161	170M3211	170M3261		
		100	360	2450	21	170M3012	170M3062	170M3112	170M3162	170M3212	170M3262		
		125	550	3700	26	170M3013	170M3063	170M3113	170M3163	170M3213	170M3263		
		160	1100	7500	30	170M3014	170M3064	170M3114	170M3164	170M3214	170M3264		
		200	2200	15,000	35	170M3015	170M3065	170M3115	170M3165	170M3215	170M3265		
		250	4200	28,500	40	170M3016	170M3066	170M3116	170M3166	170M3216	170M3266		
		315	7000	46,500	50	170M3017	170M3067	170M3117	170M3167	170M3217	170M3267		
		350	10,000	68,500	55	170M3018	170M3068	170M3118	170M3168	170M3218	170M3268		
		400	15,000	105,000	60	170M3019	170M3069	170M3119	170M3169	170M3219	170M3269		
		450	21,000	140,000	65	170M3020	170M3070	170M3120	170M3170	170M3220	170M3270		
		500	27,000	180,000	70	170M3021	170M3071	170M3121	170M3171	170M3221	170M3271		
		550	34,000	230,000	75	170M3022	170M3072	170M3122	170M3172	170M3222	170M3272		
		630	48,500	325,000	80	170M3023	170M3073	170M3123	170M3173	170M3223	170M3273		
		1	690 V a.c. (IEC) 700 V a.c. (UL)	200	1650	11,500	45	170M4008	170M4058	170M4108	170M4158	170M4208	170M4258
250	3100			21,000	55	170M4009	170M4059	170M4109	170M4159	170M4209	170M4259		
315	6200			42,000	58	170M4010	170M4060	170M4110	170M4160	170M4210	170M4260		
350	8500			59,000	60	170M4011	170M4061	170M4111	170M4161	170M4211	170M4261		
400	13,500			91,500	65	170M4012	170M4062	170M4112	170M4162	170M4212	170M4262		
450	17,000			120,000	70	170M4013	170M4063	170M4113	170M4163	170M4213	170M4263		
500	25,000			170,000	72	170M4014	170M4064	170M4114	170M4164	170M4214	170M4264		
550	34,000			230,000	75	170M4015	170M4065	170M4115	170M4165	170M4215	170M4265		
630	52,000			350,000	80	170M4016	170M4066	170M4116	170M4166	170M4216	170M4266		
700	69,500			465,000	85	170M4017	170M4067	170M4117	170M4167	170M4217	170M4267		
800	105,000			725,000	95	170M4018	170M4068	170M4118	170M4168	170M4218	170M4268		
550 V a.c. IEC	900			155,000	850,000	100	170M4019 <sup>1</sup>	170M4069 <sup>1</sup>	170M4119 <sup>1</sup>	170M4169 <sup>1</sup>	170M4219 <sup>1</sup>	170M4269 <sup>1</sup>	
2	690 V a.c. (IEC) 700 V a.c. (UL)			400	11,000	74,000	65	170M5008	170M5058	170M5108	170M5158	170M5208	170M5258
				450	15,500	105,000	70	170M5009	170M5059	170M5109	170M5159	170M5209	170M5259
				500	21,500	145,000	75	170M5010	170M5060	170M5110	170M5160	170M5210	170M5260
				550	28,000	190,000	80	170M5011	170M5061	170M5111	170M5161	170M5211	170M5261
				630	41,000	275,000	90	170M5012	170M5062	170M5112	170M5162	170M5212	170M5262
		700	60,500	405,000	95	170M5013	170M5063	170M5113	170M5163	170M5213	170M5263		
		800	86,000	575,000	105	170M5014	170M5064	170M5114	170M5164	170M5214	170M5264		
		900	125,000	840,000	110	170M5015	170M5065	170M5115	170M5165	170M5215	170M5265		
		1000	180,000	1,250,000	115	170M5016	170M5066	170M5116	170M5166	170M5216	170M5266		
		600 V a.c. (IEC) / 700 V a.c. UL	1100	245,000	1,600,000	120	170M5017	170M5067	170M5117	170M5167	170M5217	170M5267	
		3	690 V a.c. (IEC) 700 V a.c. (UL)	1250	365,000	2,400,000	130	170M5018	170M5068	170M5118	170M5168	170M5218	170M5268
				500	14,000	95,000	95	170M6008	170M6058	170M6108	170M6158	170M6208	170M6258
				550	19,500	135,000	100	170M6009	170M6059	170M6109	170M6159	170M6209	170M6259
				630	31,000	210,000	105	170M6010	170M6060	170M6110	170M6160	170M6210	170M6260
				700	44,500	300,000	110	170M6011	170M6061	170M6111	170M6161	170M6211	170M6261
				800	69,500	465,000	115	170M6012	170M6062	170M6112	170M6162	170M6212	170M6262
				900	100,000	670,000	120	170M6013	170M6063	170M6113	170M6163	170M6213	170M6263
1000	140,000			945,000	125	170M6014	170M6064	170M6114	170M6164	170M6214	170M6264		
1100	190,000			1,300,000	130	170M6015	170M6065	170M6115	170M6165	170M6215	170M6265		
1250	290,000			1,950,000	140	170M6016	170M6066	170M6116	170M6166	170M6216	170M6266		
1400	370,000			2,450,000	155	170M6017	170M6067	170M6117	170M6167	170M6217	170M6267		
1500	460,000			3,100,000	160	170M6018	170M6068	170M6118	170M6168	170M6218	170M6268		
1600	580,000			3,900,000	160	170M6019	170M6069	170M6119	170M6169	170M6219	170M6269		
600 V a.c. IEC / 550 V a.c. UL	1800			880,000	5,250,000	165	170M6020 <sup>2</sup>	170M6070 <sup>2</sup>	170M6120	170M6170 <sup>2</sup>	170M6220 <sup>2</sup>	170M6270	
550 V a.c. IEC/UL	2000			1,150,000	6,350,000	175	170M6021	170M6071	170M6121	170M6171	170M6221	170M6271	

Data sheets: 170K6314 (Size 1\*), 170K6316 (Size 1), 170K6318 (Size 2), 170K6320 (Size 3)

<sup>1</sup> Not UL Approved IEC

<sup>2</sup> Rated at 750 V d.c. 12XIn 130 kA when two fuses connected in series

# Square body fuse links

## 170M - Sizes 1\* to 3, DIN 43653, 690 V a.c. (IEC), 700 V a.c. (UL), 40 A to 2000 A

### Time-current curve - Size 1\*, 40 A to 630 A

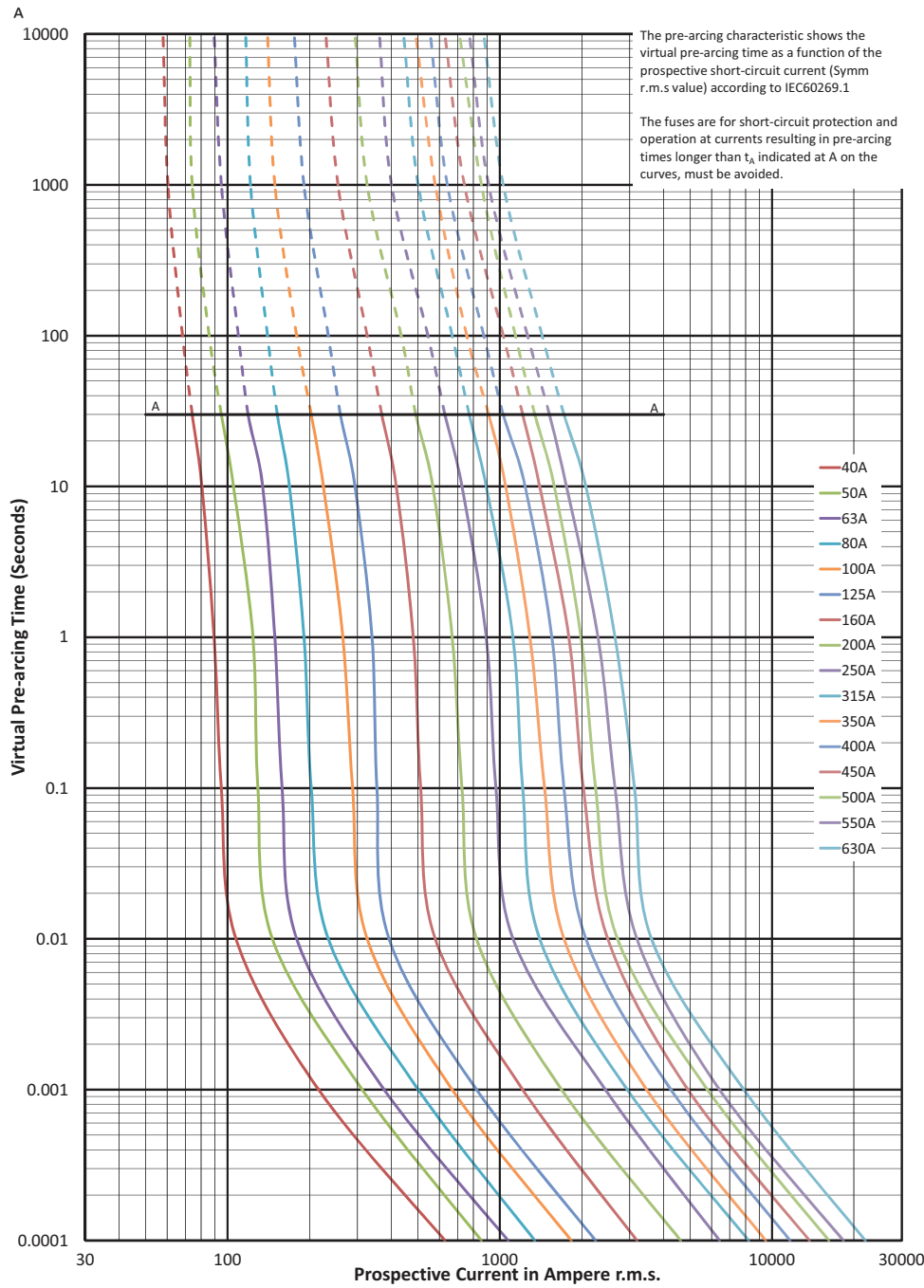

Data sheets: 170K6314 (Size 1\*), 170K6316 (Size 1), 170K6318 (Size 2), 170K6320 (Size 3)

**170M - Sizes 1\* to 3, DIN 43653, 690 V a.c. (IEC), 700 V a.c. (UL), 40 A to 2000 A**

Cut-off curve - Size 1\*, 40 A to 630 A

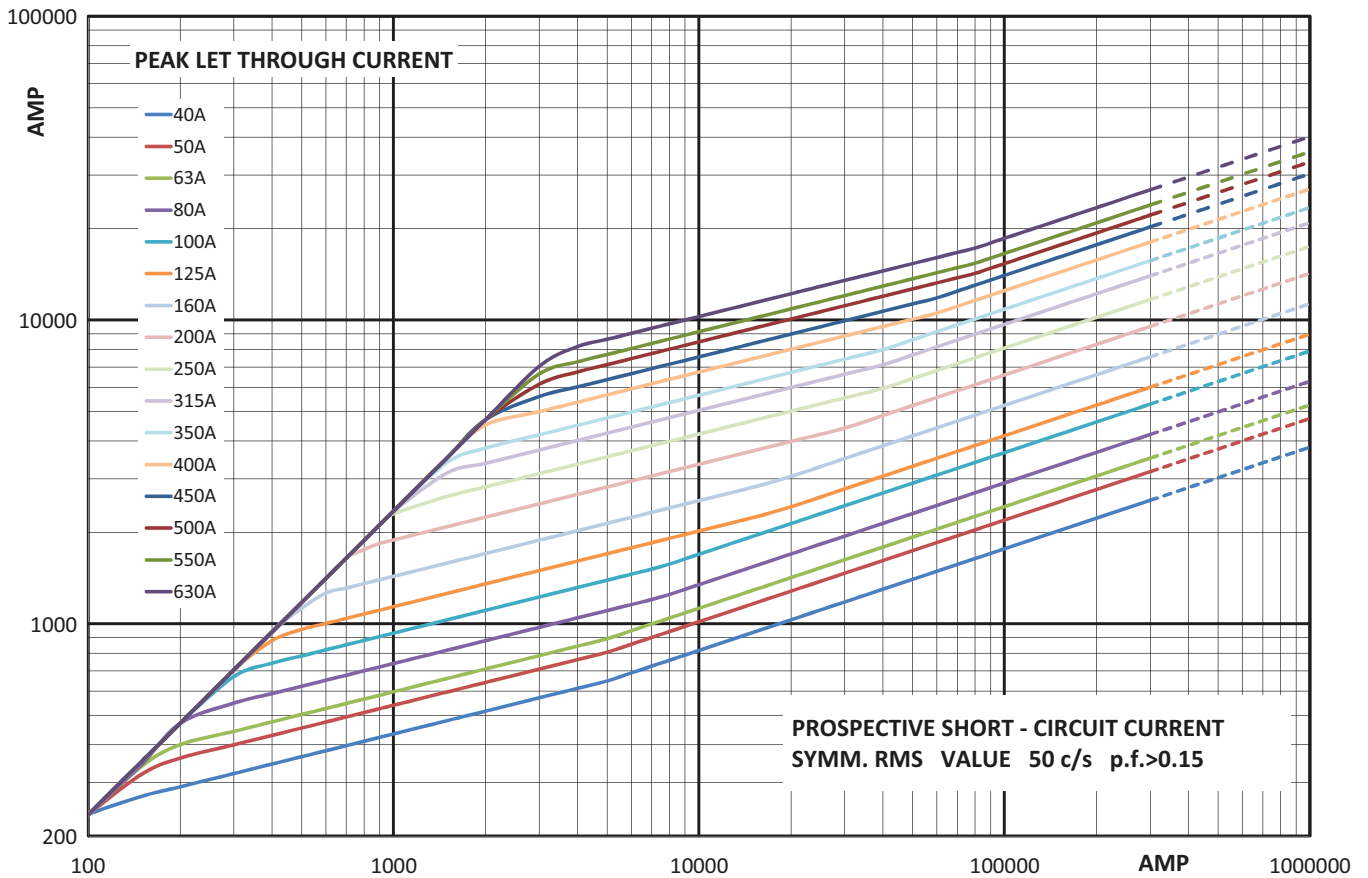

**Total clearing  $I^2t$**

The total clearing  $I^2t$  at rated voltage and at a power factor of 15 percent are given in the electrical characteristics. For other voltages, the clearing  $I^2t$  is found by multiplying by correction factor,  $K$ , given as a function of applied working voltage,  $E_g$ , (RMS).

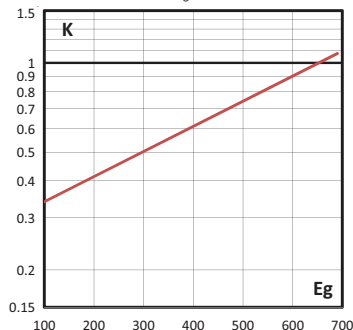

**Arc voltage**

This curve gives the peak arc voltage,  $U_L$ , which may appear across the fuse during its operation as a function of the applied working voltage,  $E_g$ , (RMS) at a power factor of 15 percent.

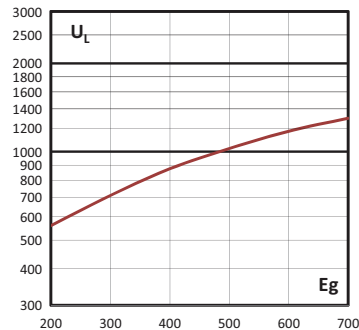

**Watts losses**

Watts loss at rated current is given in the electrical characteristics. The curve allows the calculation of the watts losses at load currents lower than the rated current. The correction factor,  $K_p$ , is given as a function of the RMS load current,  $I_b$ , in percent of the rated current.

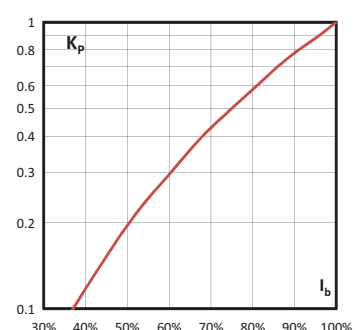

Data sheets: 170K6314 (Size 1\*), 170K6316 (Size 1), 170K6318 (Size 2), 170K6320 (Size 3)

# Square body fuse links

**170M** - Sizes 1\* to 3, DIN 43653, 690 V a.c. (IEC), 700 V a.c. (UL), 40 A to 2000 A

Time-current curve - Size 1, 200 A to 900 A

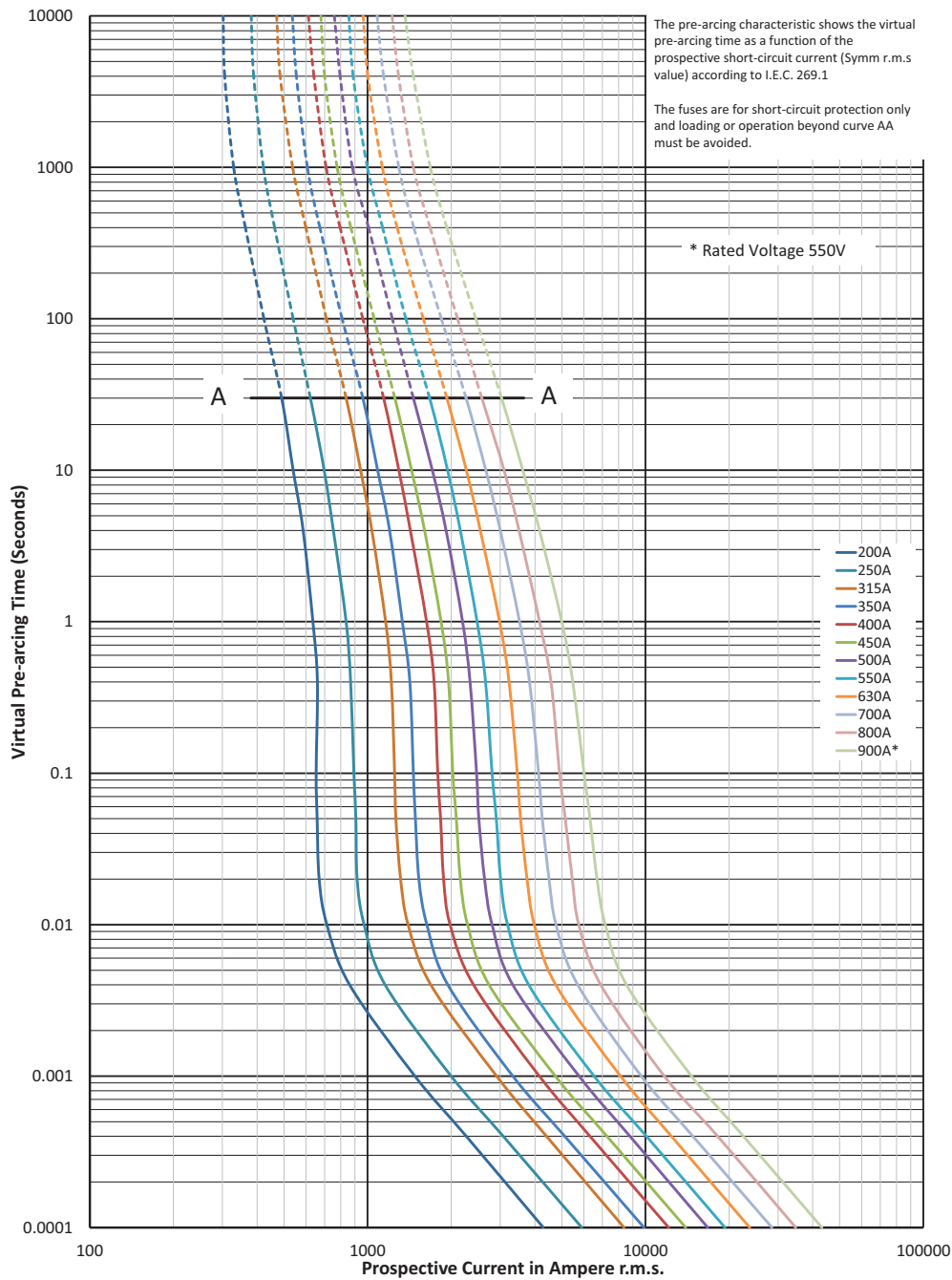

$K_b = 1$   $N = 1.5$

Data sheets: 170K6314 (Size 1\*), 170K6316 (Size 1), 170K6318 (Size 2), 170K6320 (Size 3)

**170M - Sizes 1\* to 3, DIN 43653, 690 V a.c. (IEC), 700 V a.c. (UL), 40 A to 2000 A**

**Cut-off curve - Size 1, 200 A to 900 A**

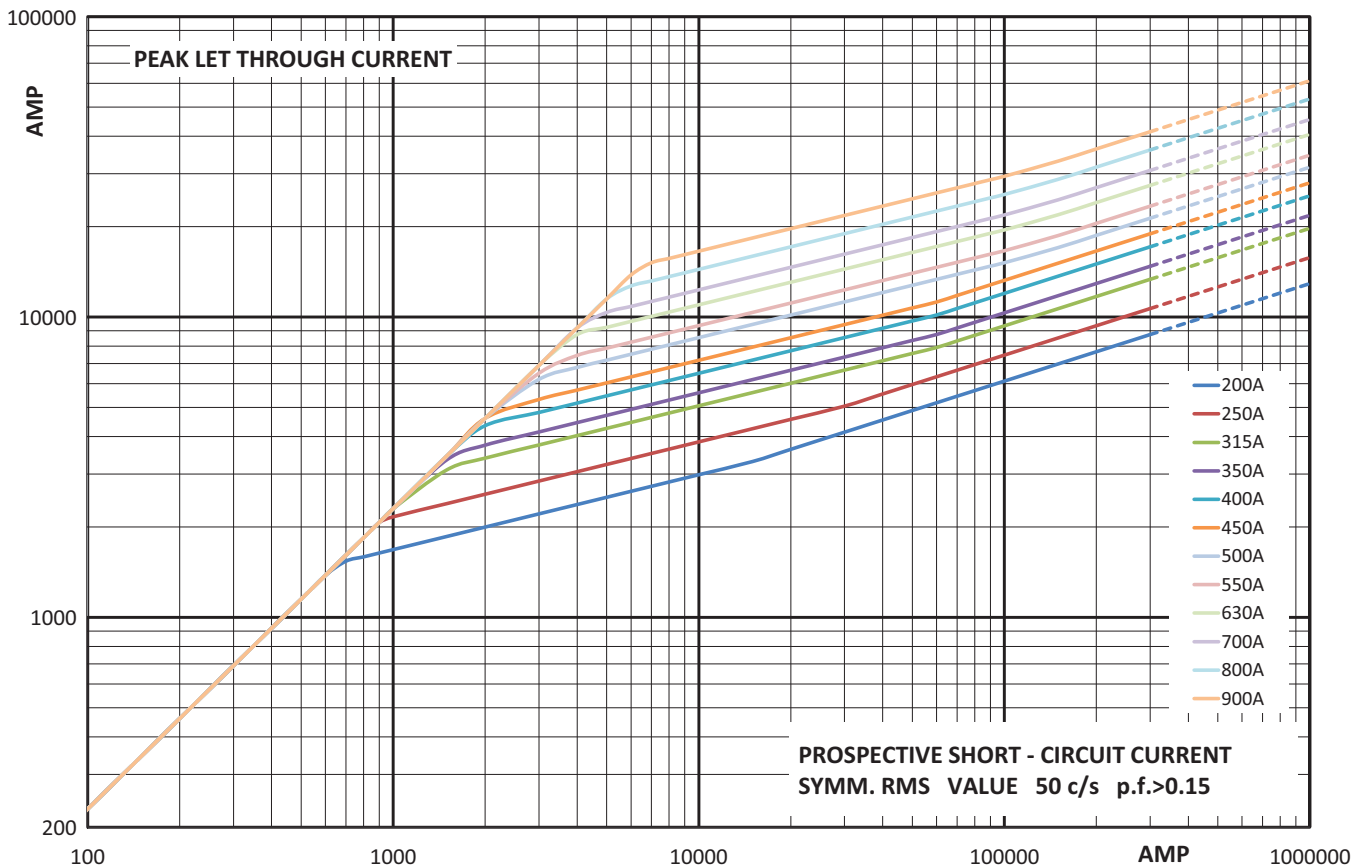

**Total clearing  $I^2t$**

The total clearing  $I^2t$  at rated voltage and at a power factor of 15 percent are given in the electrical characteristics. For other voltages, the clearing  $I^2t$  is found by multiplying by correction factor,  $K$ , given as a function of applied working voltage,  $E_g$ , (RMS).

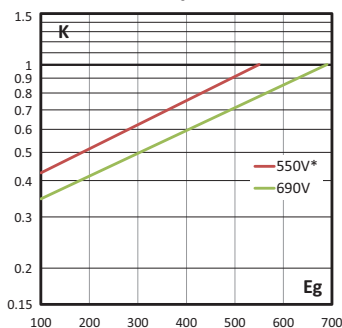

**Arc voltage**

This curve gives the peak arc voltage,  $U_L$ , which may appear across the fuse during its operation as a function of the applied working voltage,  $E_g$ , (RMS) at a power factor of 15 percent.

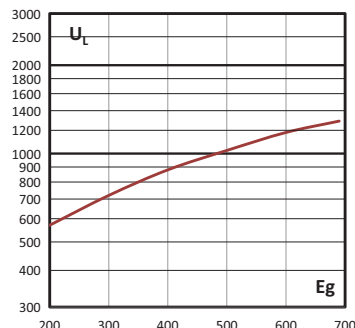

**Watts losses**

Watts loss at rated current is given in the electrical characteristics. The curve allows the calculation of the watts losses at load currents lower than the rated current. The correction factor,  $K_p$ , is given as a function of the RMS load current,  $I_b$ , in percent of the rated current.

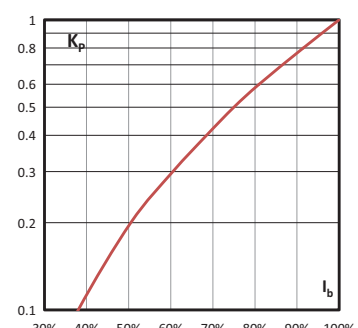

# Square body fuse links

**170M** - Sizes 1\* to 3, DIN 43653, 690 V a.c. (IEC), 700 V a.c. (UL), 40 A to 2000 A

Time-current curve - Size 2, 400 A to 1250 A

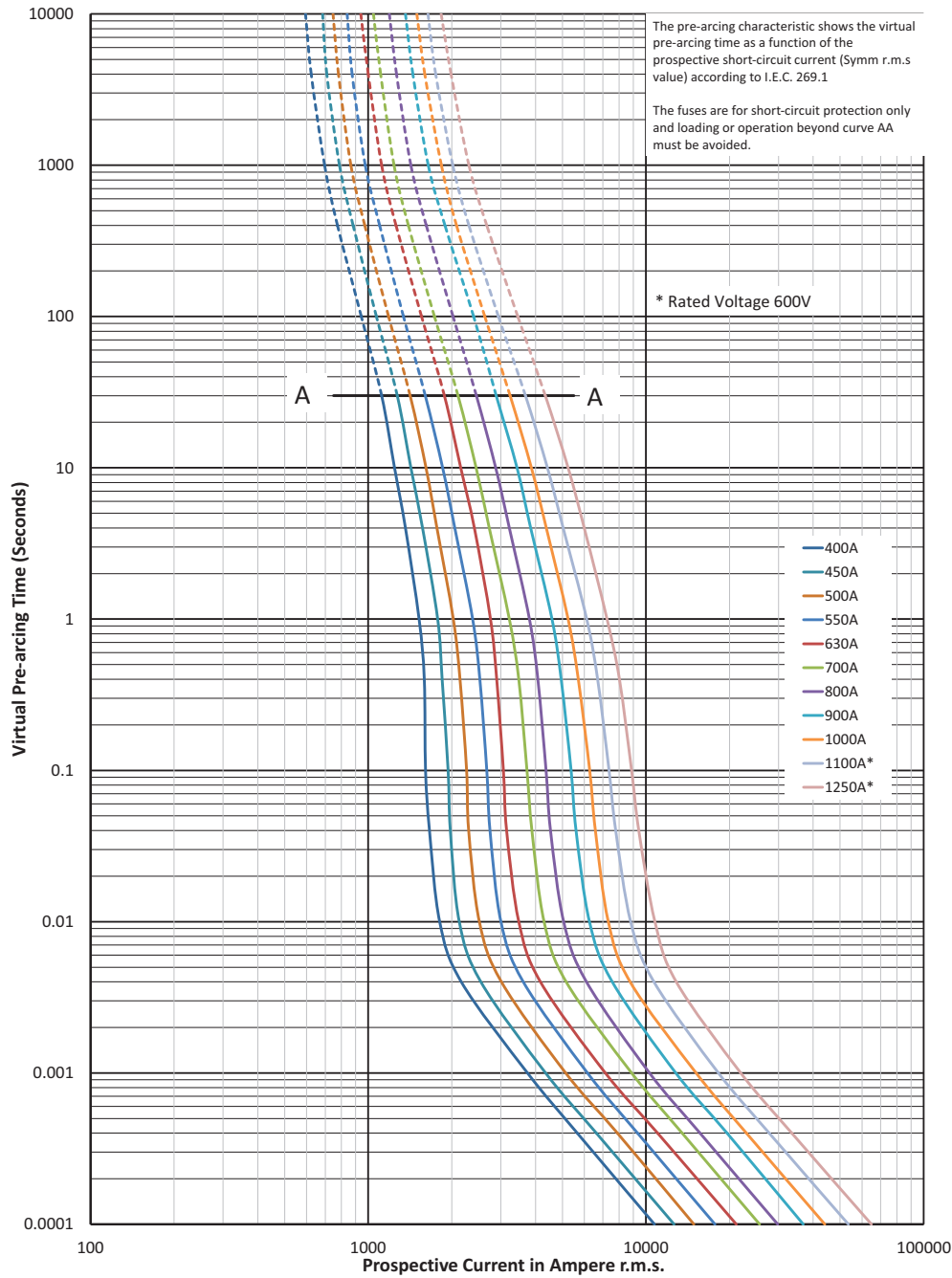

$K_b = 1$   $N = 1.5$

Data sheets: 170K6314 (Size 1\*), 170K6316 (Size 1), 170K6318 (Size 2), 170K6320 (Size 3)



**170M - Sizes 1\* to 3, DIN 43653, 690 V a.c. (IEC), 700 V a.c. (UL), 40 A to 2000 A**

**Cut-off curve - Size 2, 400 A to 1250 A**

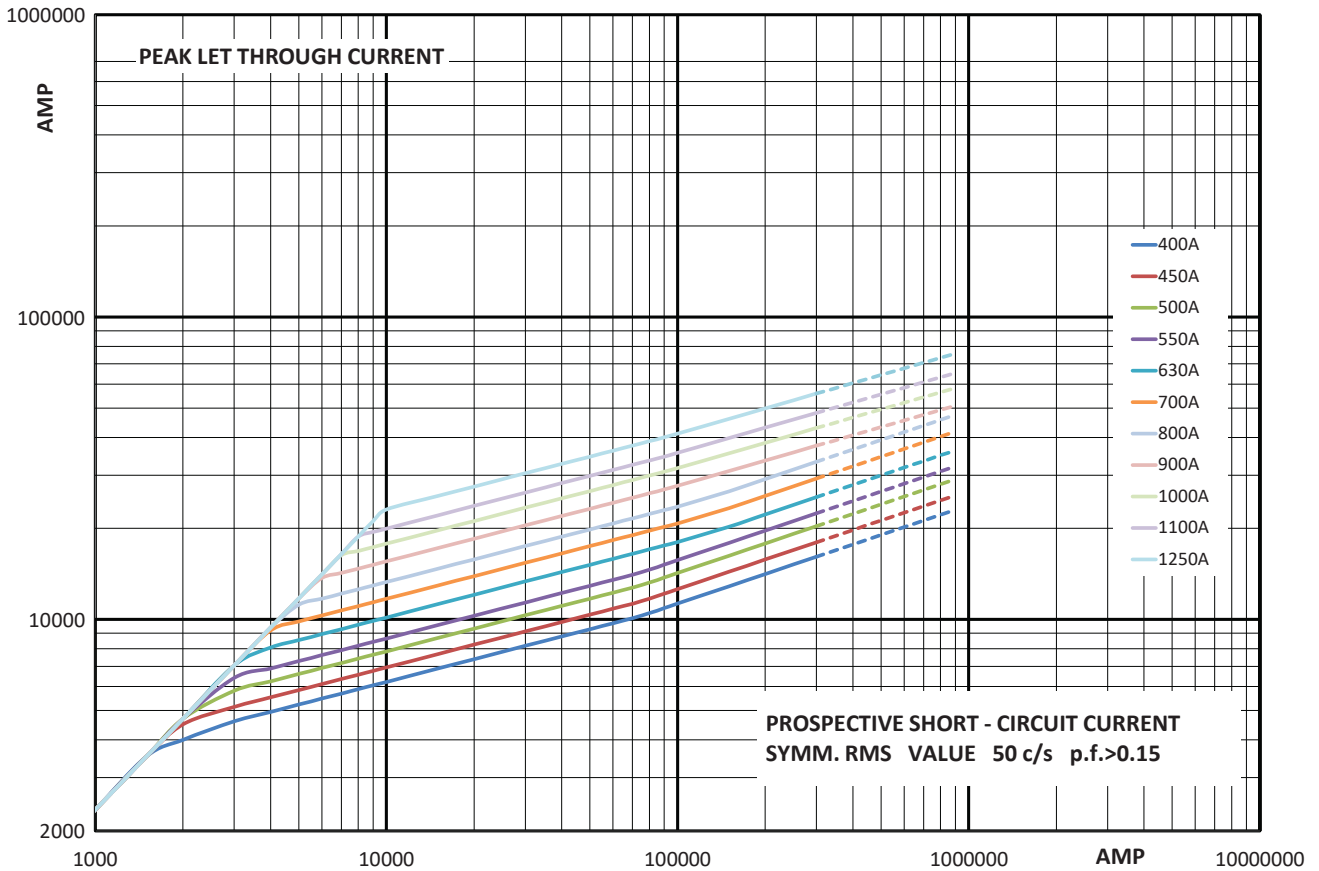

**Total clearing  $I^2t$**

The total clearing  $I^2t$  at rated voltage and at a power factor of 15 percent are given in the electrical characteristics. For other voltages, the clearing  $I^2t$  is found by multiplying by correction factor,  $K$ , given as a function of applied working voltage,  $E_g$ , (RMS).

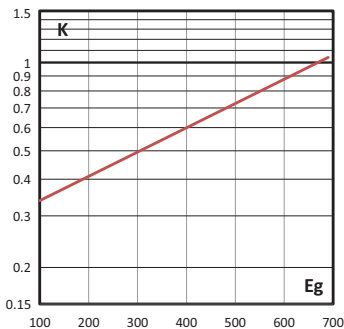

**Arc voltage**

This curve gives the peak arc voltage,  $U_L$ , which may appear across the fuse during its operation as a function of the applied working voltage,  $E_g$ , (RMS) at a power factor of 15 percent.

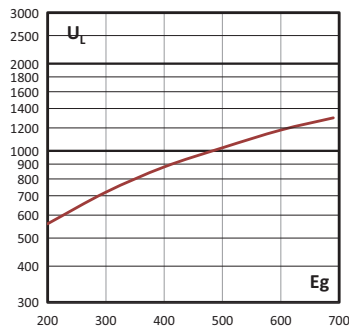

**Watts losses**

Watts loss at rated current is given in the electrical characteristics. The curve allows the calculation of the watts losses at load currents lower than the rated current. The correction factor,  $K_p$ , is given as a function of the RMS load current,  $I_b$ , in percent of the rated current.

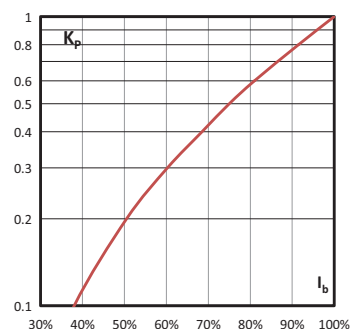

Data sheets: 170K6314 (Size 1\*), 170K6316 (Size 1), 170K6318 (Size 2), 170K6320 (Size 3)

# Square body fuse links

## 170M - Sizes 1\* to 3, DIN 43653, 690 V a.c. (IEC), 700 V a.c. (UL), 40 A to 2000 A

### Time-current curve - Size 3, 500 A to 2000 A

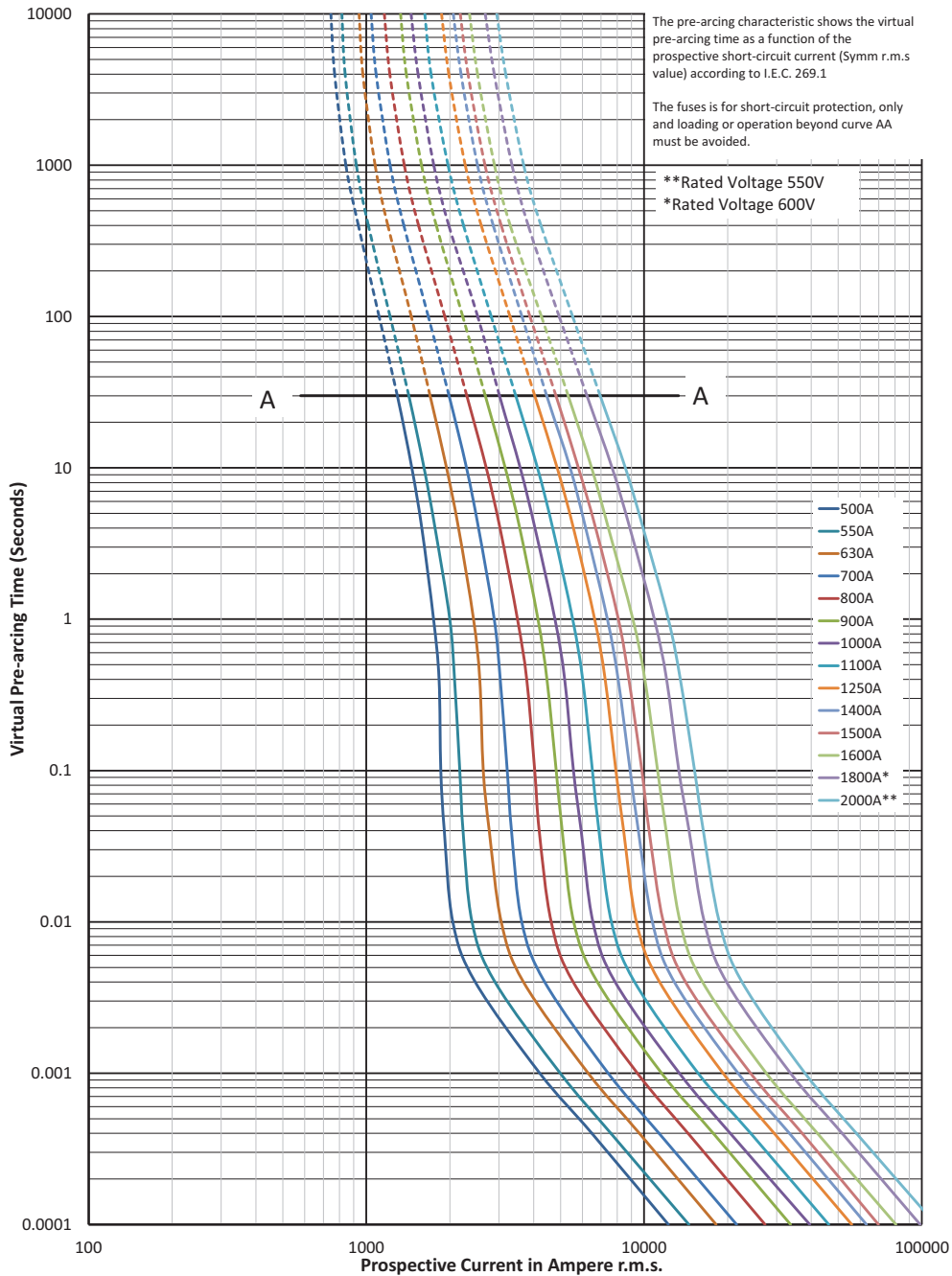

$K_b = 1$     $N = 1.5$

Data sheets: 170K6314 (Size 1\*), 170K6316 (Size 1), 170K6318 (Size 2), 170K6320 (Size 3)

**170M - Sizes 1\* to 3, DIN 43653, 690 V a.c. (IEC), 700 V a.c. (UL), 40 A to 2000 A**

**Cut-off curve - Size 3, 500 A to 2000 A**

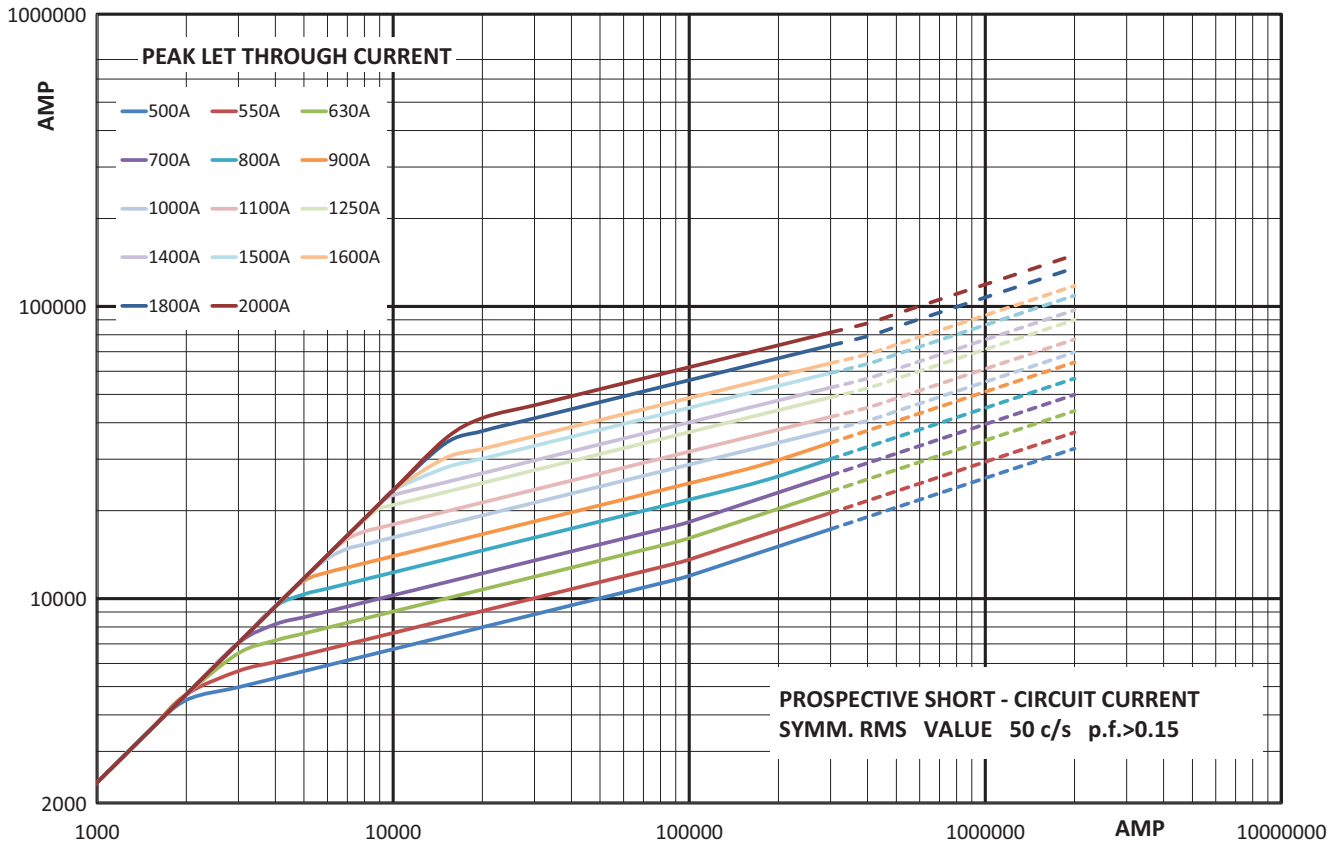

**Total clearing I<sup>2</sup>t**

The total clearing I<sup>2</sup>t at rated voltage and at a power factor of 15 percent are given in the electrical characteristics. For other voltages, the clearing I<sup>2</sup>t is found by multiplying by correction factor, K, given as a function of applied working voltage, E<sub>g</sub>, (RMS).

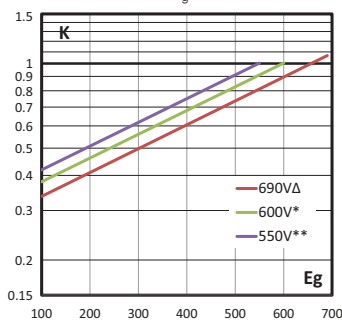

**Arc voltage**

This curve gives the peak arc voltage, U<sub>L</sub>, which may appear across the fuse during its operation as a function of the applied working voltage, E<sub>g</sub>, (RMS) at a power factor of 15 percent.

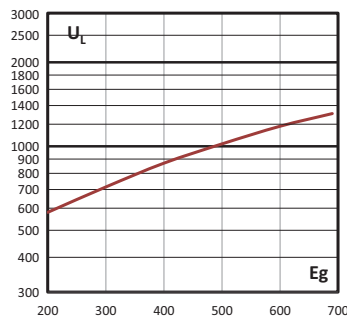

**Watts losses**

Watts loss at rated current is given in the electrical characteristics. The curve allows the calculation of the watts losses at load currents lower than the rated current. The correction factor, K<sub>p</sub>, is given as a function of the RMS load current, I<sub>b</sub>, in percent of the rated current.

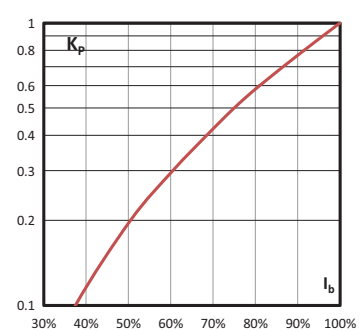

# Square body fuse links

## 170M - Size 00, DIN 43653, 1000 V a.c. (IEC and UL), 20 A to 315A

### Specifications

#### Description

Square body DIN 43653 bolted tags high speed fuse links, for the protection of DC common bus, DC drives, power converters/rectifiers and reduced rated voltage starters.

#### Technical data

- Rated voltage:
  - 1000 V a.c. (IEC and UL 20 A to 250 A)
  - 900 V a.c. (IEC, 315 A)
- Rated current: 20 A to 315 A
- Breaking capacity: 125 kA RMS Sym
- Operating class: aR



#### Standards / Agency information

CE, Designed and tested to IEC60269 Part 4, UL Recognised/CSA component acceptance status (20-250 A)

#### Catalogue numbers

Fuse link body size	Rated voltage	I <sup>2</sup> t (A <sup>2</sup> Sec)				Catalogue numbers	
		Rated current (Amps)	Pre-arcing	Clearing at rated voltage	Watts loss (W)	00/80 Visual indicator	00TN/80 Type T indicator for micro
00	1000 V a.c. (IEC/UL)	20	20	140	5	170M4802	170M4822
		25	30	210	7	170M4803	170M4823
		32	55	390	9	170M4804	170M4824
		35	69	500	10	170M4805	170M4825
		40	100	690	11	170M4806	170M4826
		50	170	1200	13	170M4807	170M4827
		63	280	2000	18	170M4808	170M4828
		80	500	3500	22	170M4809	170M4829
		100	950	6850	25	170M4810	170M4830
		125	1500	11,500	33	170M4811	170M4831
		160	3000	22,000	37	170M4812	170M4832
		200	5600	40,500	40	170M4813	170M4833
		250	10,000	74,000	48	170M4814	170M4834
		315	18,000	115,000	58	170M4815	170M4835
			900 V a.c. (IEC)				

#### Dimensions (mm)

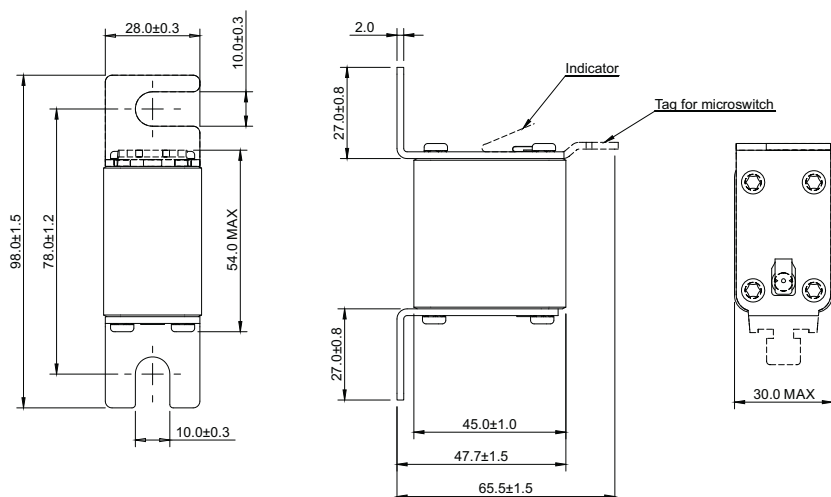

**170M - Size 00, DIN 43653, 1000 V a.c. (IEC and UL), 20 A to 315A**

Time-current curve - 20 A to 315 A

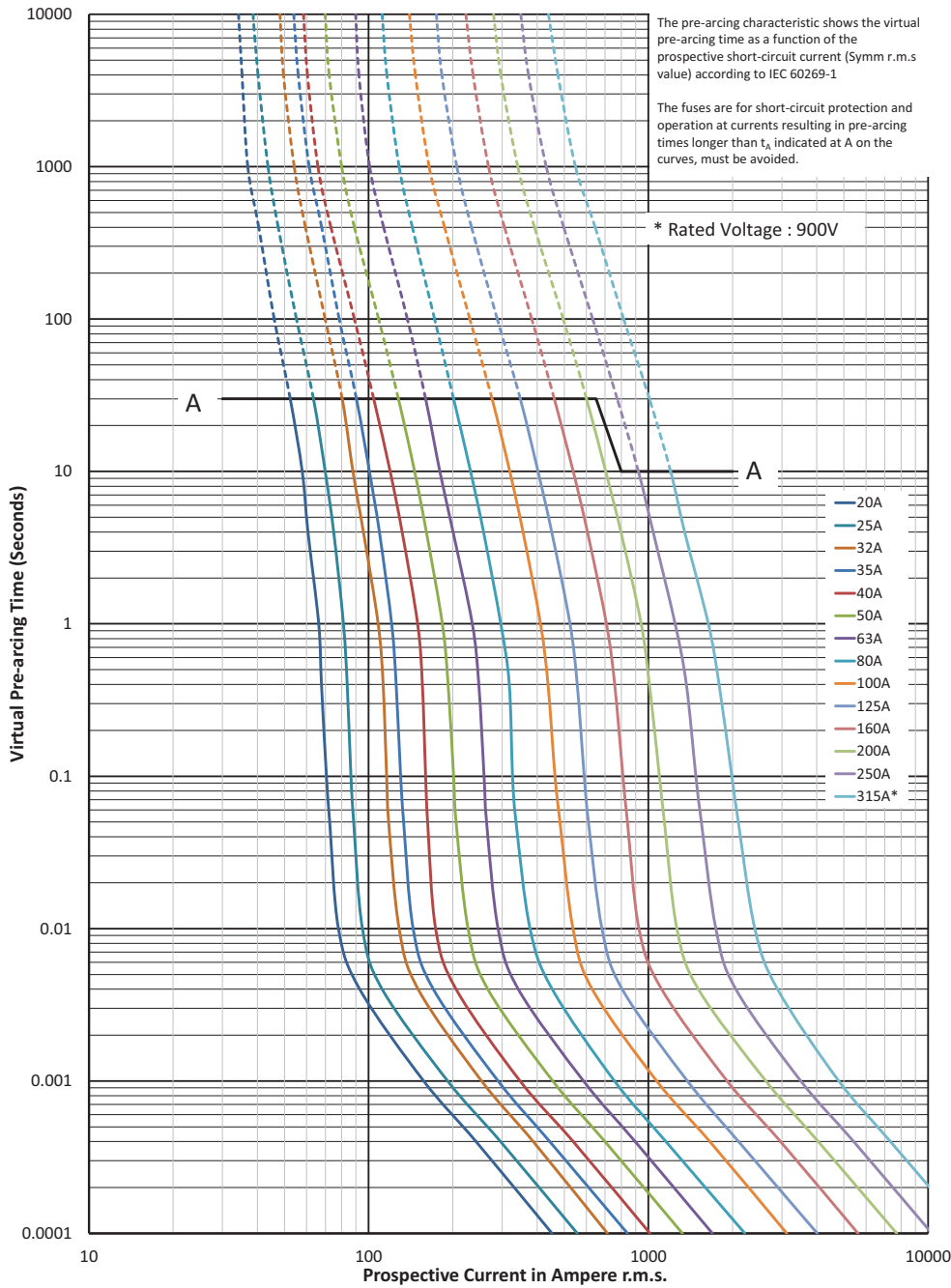

$K_b = 1$   $N = 1.6$

# Square body fuse links

## 170M - Size 00, DIN 43653, 1000 V a.c. (IEC and UL), 20 A to 315A

### Cut-off curve - 20 A to 315 A

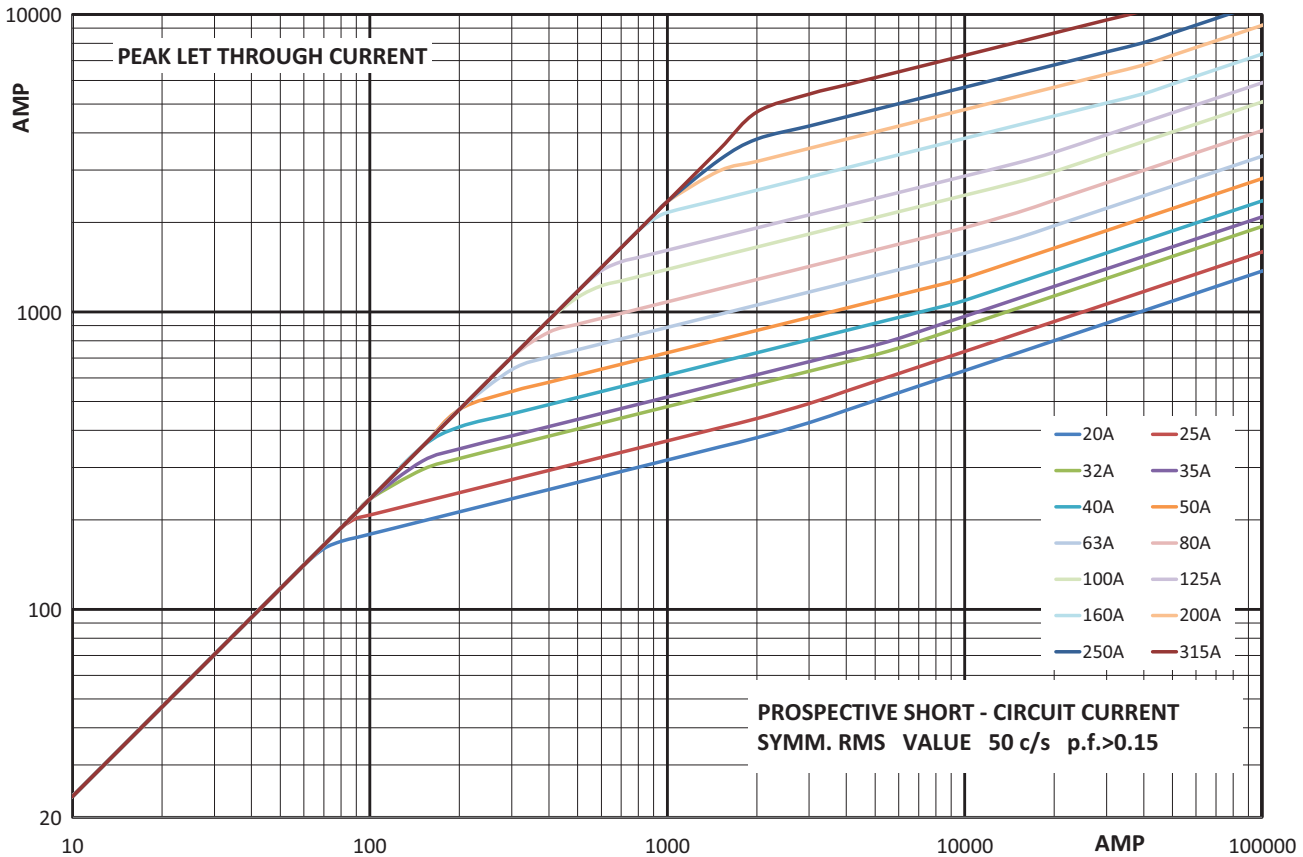

### Total clearing $I^2t$

The total clearing  $I^2t$  at rated voltage and at a power factor of 15 percent are given in the electrical characteristics. For other voltages, the clearing  $I^2t$  is found by multiplying by correction factor,  $K$ , given as a function of applied working voltage,  $E_g$ , (RMS).

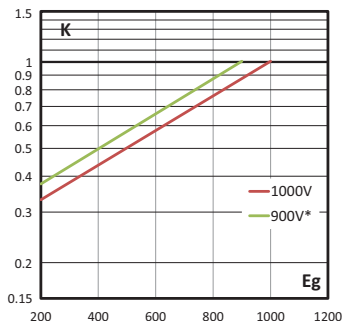

### Arc voltage

This curve gives the peak arc voltage,  $U_L$ , which may appear across the fuse during its operation as a function of the applied working voltage,  $E_g$ , (RMS) at a power factor of 15 percent.

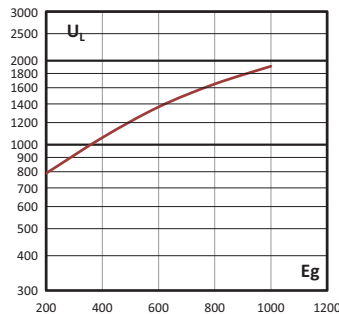

### Watts losses

Watts loss at rated current is given in the electrical characteristics. The curve allows the calculation of the watts losses at load currents lower than the rated current. The correction factor,  $K_p$ , is given as a function of the RMS load current,  $I_b$ , in percent of the rated current.

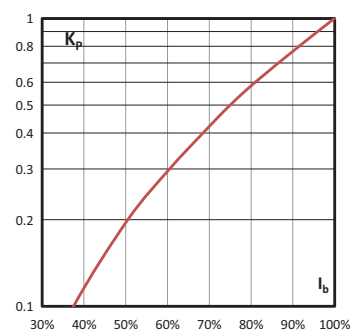

## 170M - Sizes 1\* to 3, DIN 43653, 1000 V a.c. (IEC and UL), 50 A to 1400 A

### Specifications

#### Description

Square body DIN 43653 bolted tags high speed fuse links, for the protection of DC common bus, DC drives, power converters / rectifiers and reduced rated voltage starters.

#### Technical data

- Rated voltage:
  - 1000 V a.c. (IEC, 50 A to 1250 A), 900 V a.c. (IEC, 1400 A)
  - 1000 V a.c. (UL size 2, size 3, 315 A to 1100 A only)
- Rated current: 50 A to 1400 A
- Breaking Capacity:
  - 125kA RMS Sym. AC
  - Size 1: 50 kA for 750 V d.c.
- Operating Class: aR

#### Standards/Agency Information

CE, Designed and tested to IEC60269 Part 4, UL Recognised (only sizes 2 and 3), CCC only size 3 (315 A to 1100 A)



#### Dimensions (mm) -KN/110

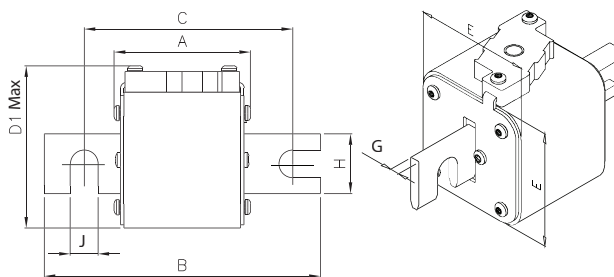

Size	A	B	C	D1 (max)	E	G	H	J
1*KN/110	80	138	108	61	43	6	22	11
1KN/110	80	138	108	69	51	6	25	11
2KN/110	80	138	108	77	59	6	25	11
3KN/110	81	139	108	92	74	6	30	11

#### Dimensions (mm) -TN/110

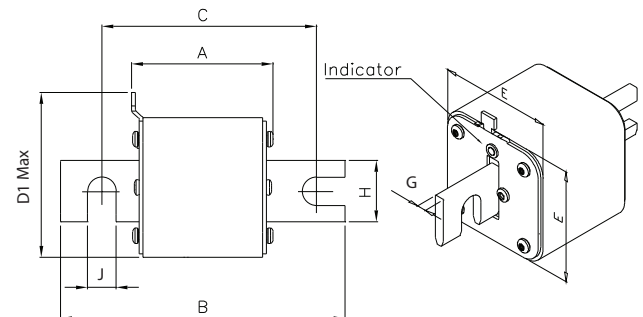

Size	A	B	C	D1 (max)	E	G	H	J
1*TN/110	80	138	108	61	43	6	22	11
1TN/110	80	138	108	69	51	6	25	11
2TN/110	80	138	108	75	59	6	25	11
3TN/110	81	139	108	90	74	6	30	11

Data sheets: 170K8564 (Size 1\*), 170K8566 (Size 1), 170K8568 (Size 2), 170K8570 (Size 3)

# Square body fuse links

## 170M - Sizes 1\* to 3, DIN 43653, 1000 V a.c. (IEC and UL), 50 A to 1400 A

### Catalogue numbers

Fuse link body size	Rated voltage	I <sup>2</sup> t (A <sup>2</sup> Sec)				Catalogue numbers	
		Rated current (Amps)	Pre-arcing	Clearing at rated voltage	Watts loss (W)	-KN/110 Type K indicator for micro	-TN/110 Type T indicator for micro
1*	1000 V a.c. (IEC)	50	135	815	20	170M3965	170M3981
		63	215	1300	25	170M3966	170M3982
		80	460	2750	30	170M3967	170M3983
		100	860	5100	35	170M3968	170M3984
		125	1450	8600	40	170M3969	170M3985
		160	2850	17,500	45	170M3970	170M3986
		200	4950	29,500	50	170M3971	170M3987
		250	9550	57,000	55	170M3972	170M3988
		315	21,500	130,000	65	170M3973	170M3989
		350	29,000	175,000	70	170M3974	170M3990
1	1000 V a.c. (IEC)	160	2200	13,500	40	170M4965	170M4980
		200	4150	24,500	45	170M4966	170M4981
		250	7750	46,000	52	170M4967	170M4982
		315	16,500	98,500	60	170M4968	170M4983
	1000 V a.c. / 750 V d.c. (UL)	350	21,500	130,000	65	170M4969	170M4984
		400	31,000	185,000	70	170M4970	170M4985
		450	44,500	265,000	80	170M4971	170M4986
		500	63,000	375,000	85	170M4972	170M4987
2	1000 V a.c. (IEC and UL)	550	84,500	500,000	90	170M4973	170M4988
		630	125,000	755,000	98	170M4974	170M4989
		250	6750	40,000	65	170M5966	170M5981
		315	13,500	81,500	75	170M5967	170M5982
		350	16,500	99,000	80	170M5968	170M5983
		400	26,000	155,000	85	170M5969	170M5984
		450	35,500	210,000	90	170M5970	170M5985
		500	49,500	295,000	95	170M5971	170M5986
		550	66,000	390,000	100	170M5972	170M5987
		630	93,500	555,000	110	170M5973	170M5988
3	1000 V a.c. (IEC and UL)	700	130,000	770,000	115	170M5974	170M5989
		800	195,000	1,200,000	125	170M5975	170M5990
		315	9200	54,500	90	170M8614	170M8629 <sup>1</sup>
		350	13,000	77,500	95	170M8615	170M8630 <sup>1</sup>
		400	19,000	115,000	105	170M8616	170M8631 <sup>1</sup>
		450	27,000	160,000	107	170M8617	170M8632 <sup>1</sup>
		500	37,500	225,000	110	170M8618	170M8633 <sup>1</sup>
		550	52,000	310,000	115	170M8619	170M8634 <sup>1</sup>
		630	82,500	490,000	120	170M8620	170M8635 <sup>1</sup>
		700	115,000	700,000	125	170M8621	170M8636 <sup>1</sup>
		800	170,000	1,050,000	135	170M8622	170M8637 <sup>1</sup>
		900	250,000	1,500,000	145	170M8623	170M8638 <sup>1</sup>
		1000	340,000	2,050,000	150	170M8624	170M8639 <sup>1</sup>
1100	460,000	2,750,000	155	170M8625	170M8640 <sup>1</sup>		
	1000 V a.c. (IEC)	1250	575,000	3,400,000	175	170M8626	170M8641
	900 V a.c. (IEC)	1400	795,000	4,200,000	185	170M8627	170M8642

<sup>1</sup> Rated at 900 V d.c. 8XIn 90 kA

Data sheets: 170K8564 (Size 1\*), 170K8566 (Size 1), 170K8568 (Size 2), 170K8570 (Size 3)



**170M - Sizes 1\* to 3, DIN 43653, 1000 V a.c. (IEC and UL), 50 A to 1400 A**

**Time-current curve - Size 1\* - 50 A to 400 A**

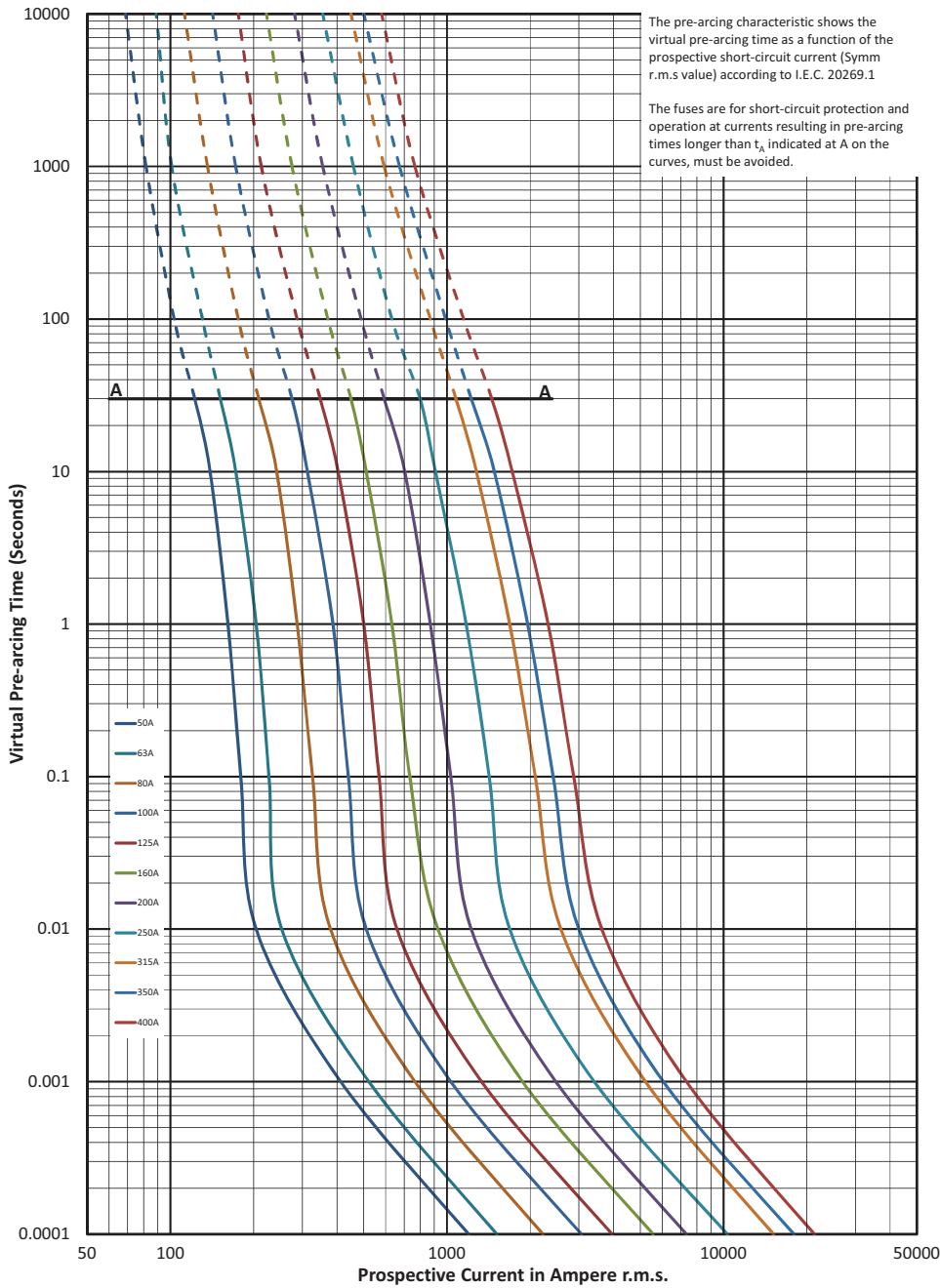

# Square body fuse links

## 170M - Sizes 1\* to 3, DIN 43653, 1000 V a.c. (IEC and UL), 50 A to 1400 A

### Cut-off curve - Size 1\*, 50 A to 400 A

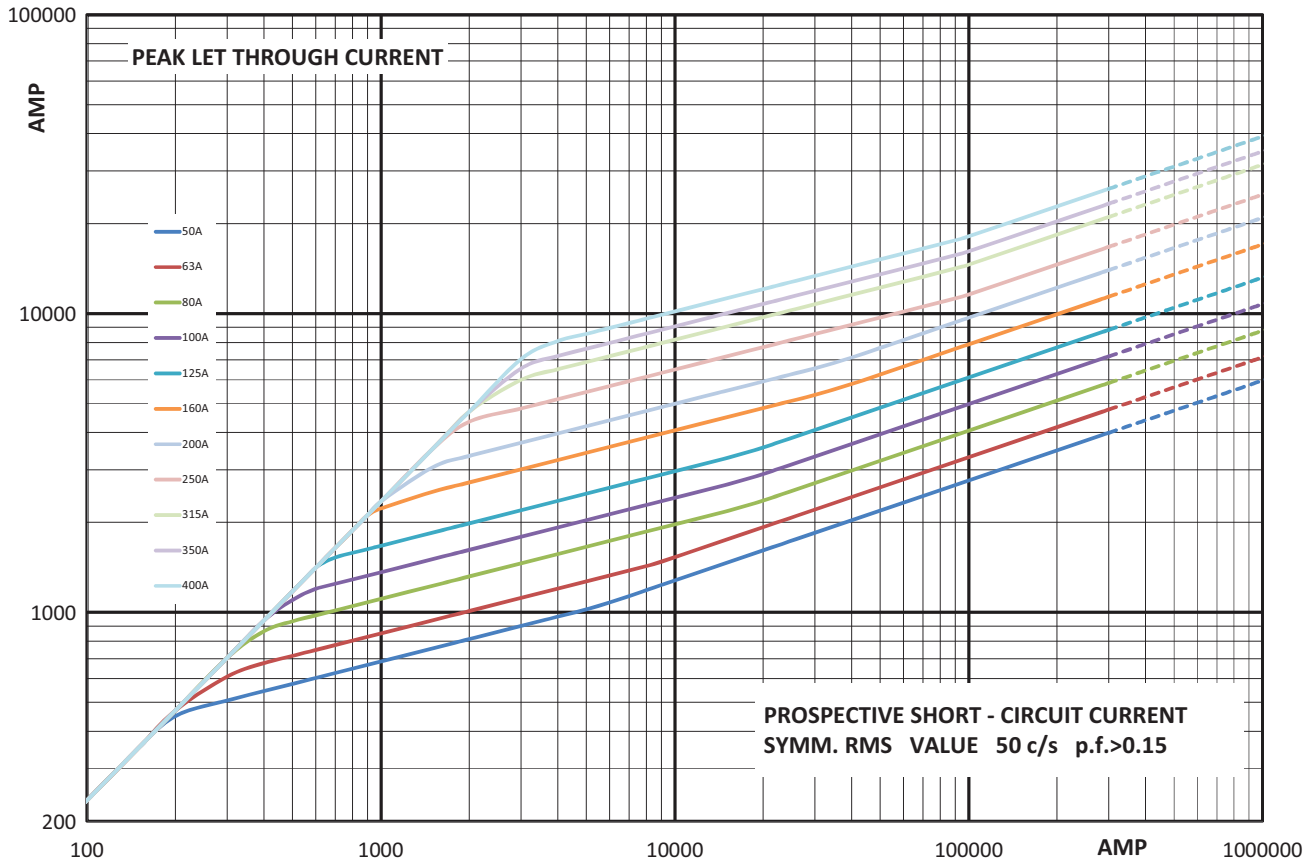

### Total clearing $I^2t$

The total clearing  $I^2t$  at rated voltage and at a power factor of 15 percent are given in the electrical characteristics. For other voltages, the clearing  $I^2t$  is found by multiplying by correction factor,  $K$ , given as a function of applied working voltage,  $E_g$ , (RMS).

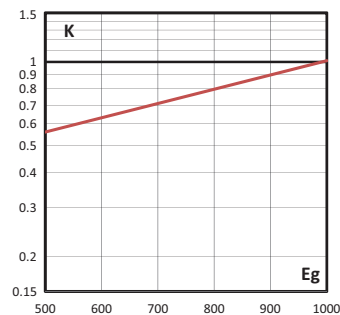

### Arc voltage

This curve gives the peak arc voltage,  $U_L$ , which may appear across the fuse during its operation as a function of the applied working voltage,  $E_g$ , (RMS) at a power factor of 15 percent.

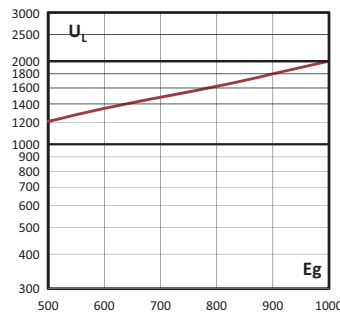

### Watts losses

Watts loss at rated current is given in the electrical characteristics. The curve allows the calculation of the watts losses at load currents lower than the rated current. The correction factor,  $K_p$ , is given as a function of the RMS load current,  $I_b$ , in percent of the rated current.

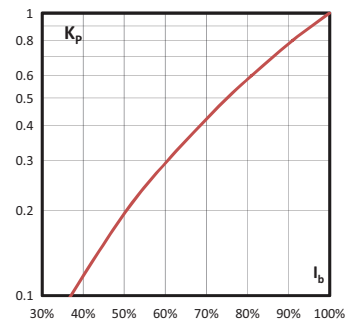

**170M - Sizes 1\* to 3, DIN 43653, 1000 V a.c. (IEC and UL), 50 A to 1400 A**

**Time-current curve - Size 1, 160 A to 630 A**

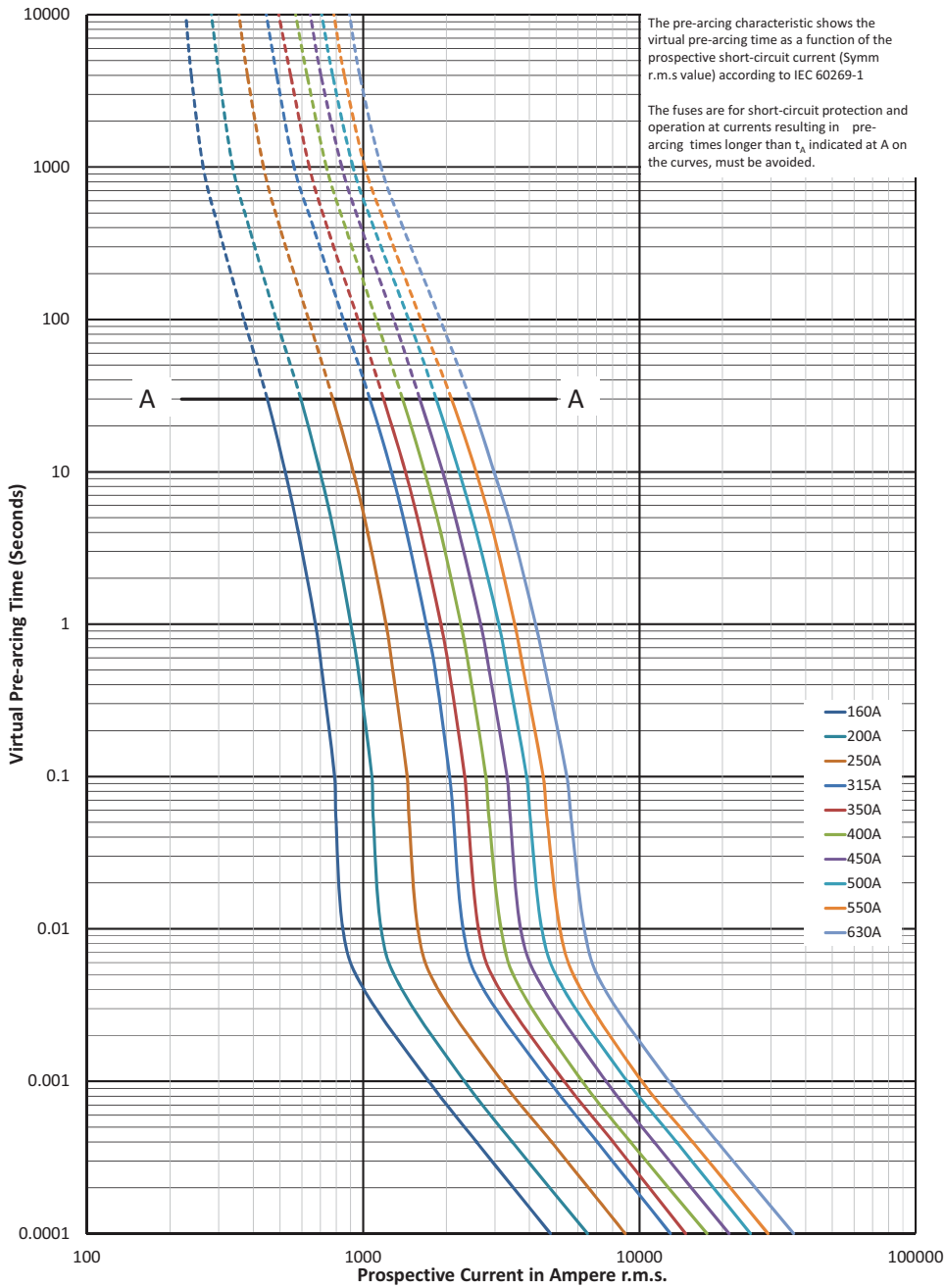

# Square body fuse links

## 170M - Sizes 1\* to 3, DIN 43653, 1000 V a.c. (IEC and UL), 50 A to 1400 A

### Cut-off curve - Size 1, 160 A to 630 A

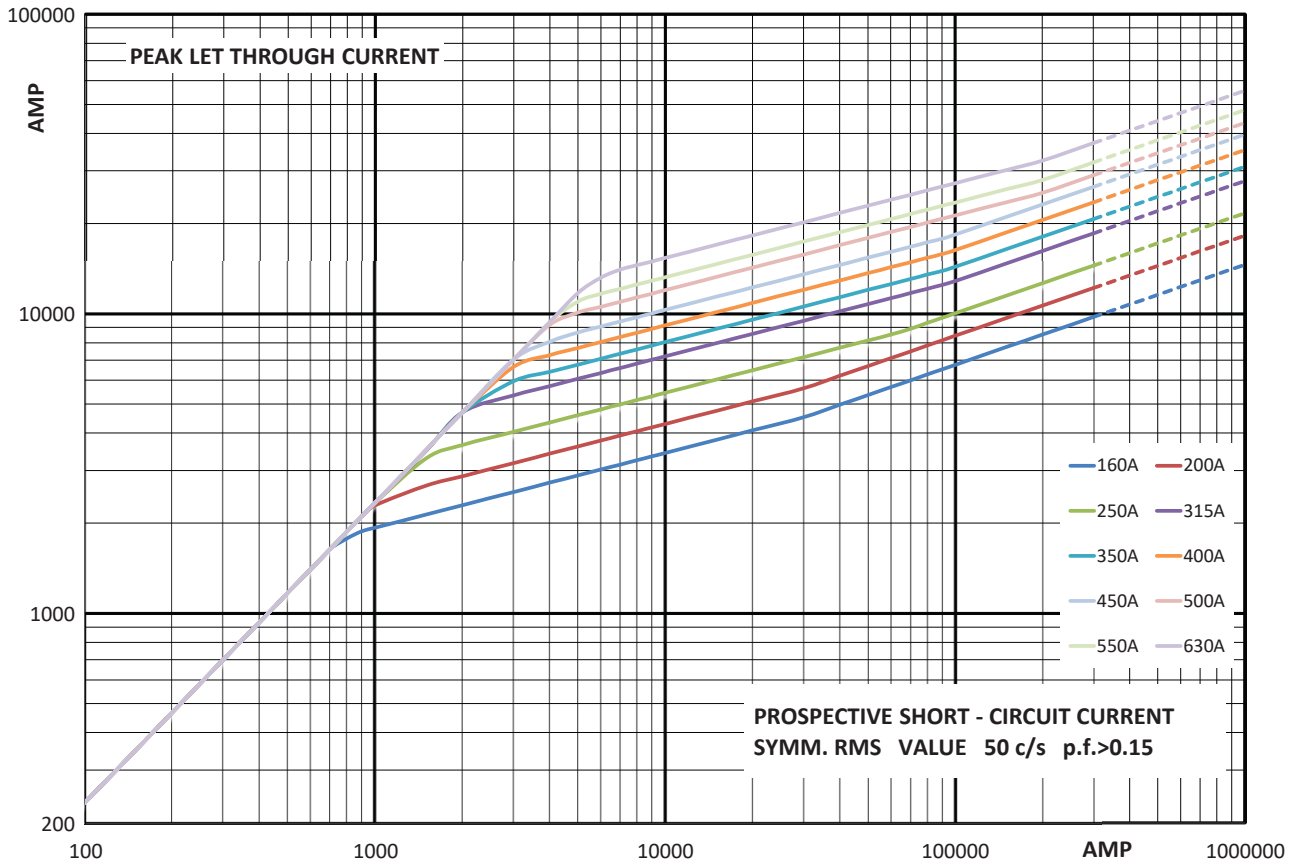

### Total clearing $I^2t$

The total clearing  $I^2t$  at rated voltage and at a power factor of 15 percent are given in the electrical characteristics. For other voltages, the clearing  $I^2t$  is found by multiplying by correction factor,  $K$ , given as a function of applied working voltage,  $E_g$ , (RMS).

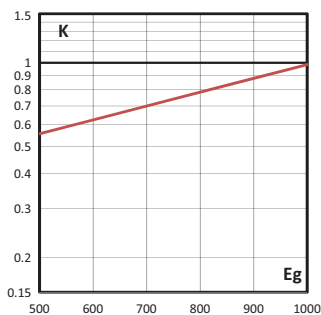

### Arc voltage

This curve gives the peak arc voltage,  $U_L$ , which may appear across the fuse during its operation as a function of the applied working voltage,  $E_g$ , (RMS) at a power factor of 15 percent.

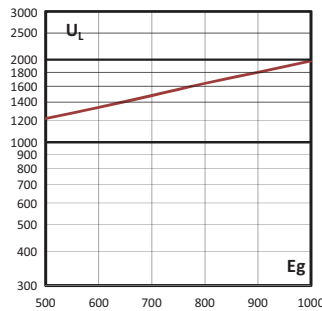

### Watts losses

Watts loss at rated current is given in the electrical characteristics. The curve allows the calculation of the watts losses at load currents lower than the rated current. The correction factor,  $K_p$ , is given as a function of the RMS load current,  $I_b$ , in percent of the rated current.

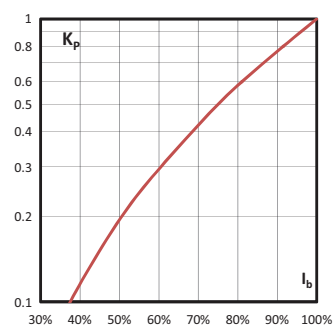

**170M** - Sizes 1\* to 3, DIN 43653, 1000 V a.c. (IEC and UL), 50 A to 1400 A

Time-current curve - Size 2, 250 A to 800 A

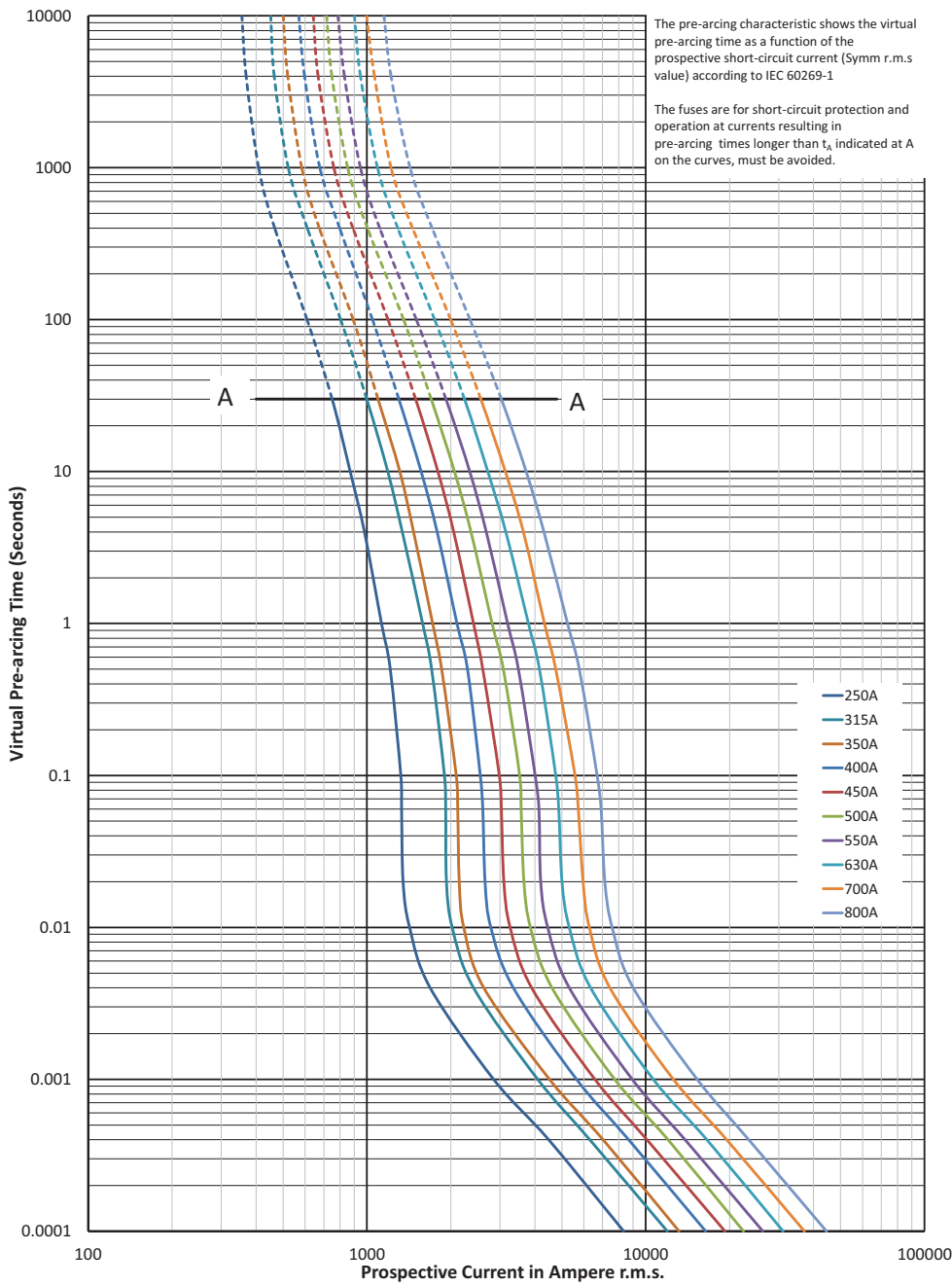

# Square body fuse links

## 170M - Sizes 1\* to 3, DIN 43653, 1000 V a.c. (IEC and UL), 50 A to 1400 A

### Cut-off curve - Size 2, 250 A to 800 A

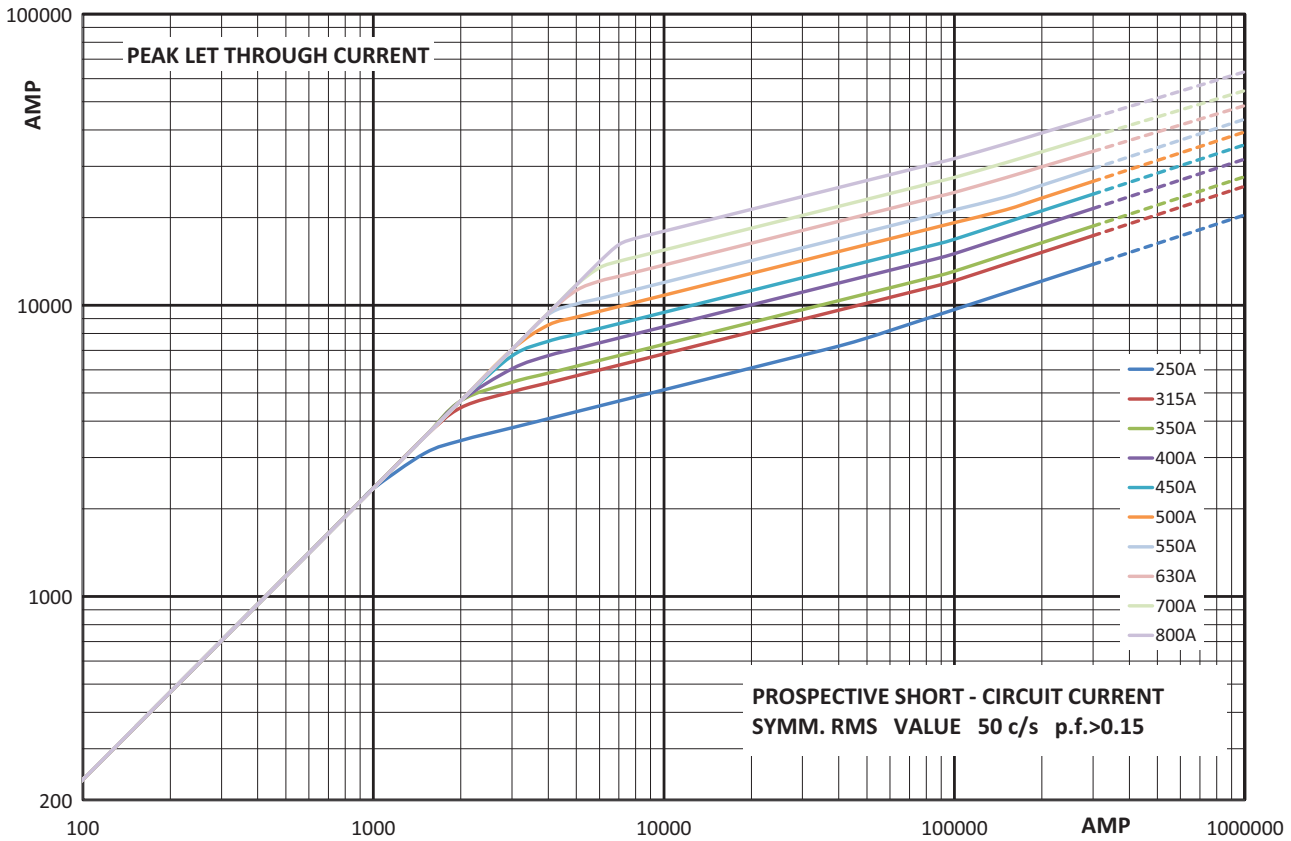

### Total clearing $I^2t$

The total clearing  $I^2t$  at rated voltage and at a power factor of 15 percent are given in the electrical characteristics. For other voltages, the clearing  $I^2t$  is found by multiplying by correction factor,  $K$ , given as a function of applied working voltage,  $E_g$ , (RMS).

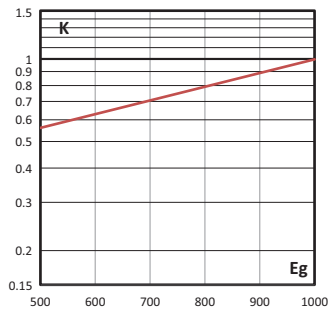

### Arc voltage

This curve gives the peak arc voltage,  $U_L$ , which may appear across the fuse during its operation as a function of the applied working voltage,  $E_g$ , (RMS) at a power factor of 15 percent.

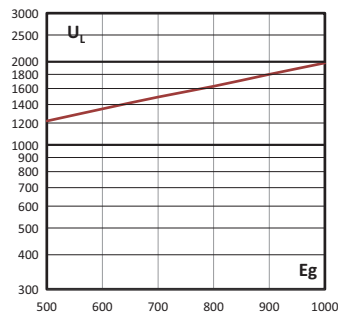

### Watts losses

Watts loss at rated current is given in the electrical characteristics. The curve allows the calculation of the watts losses at load currents lower than the rated current. The correction factor,  $K_p$ , is given as a function of the RMS load current,  $I_b$ , in percent of the rated current.

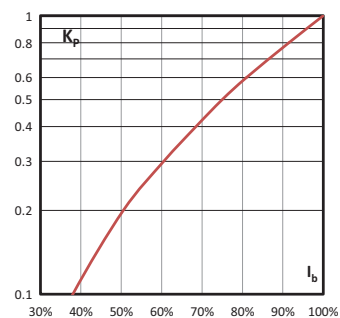

**170M** - Sizes 1\* to 3, DIN 43653, 1000 V a.c. (IEC and UL), 50 A to 1400 A

Time-current curve - Size 3, 315 A to 1400 A

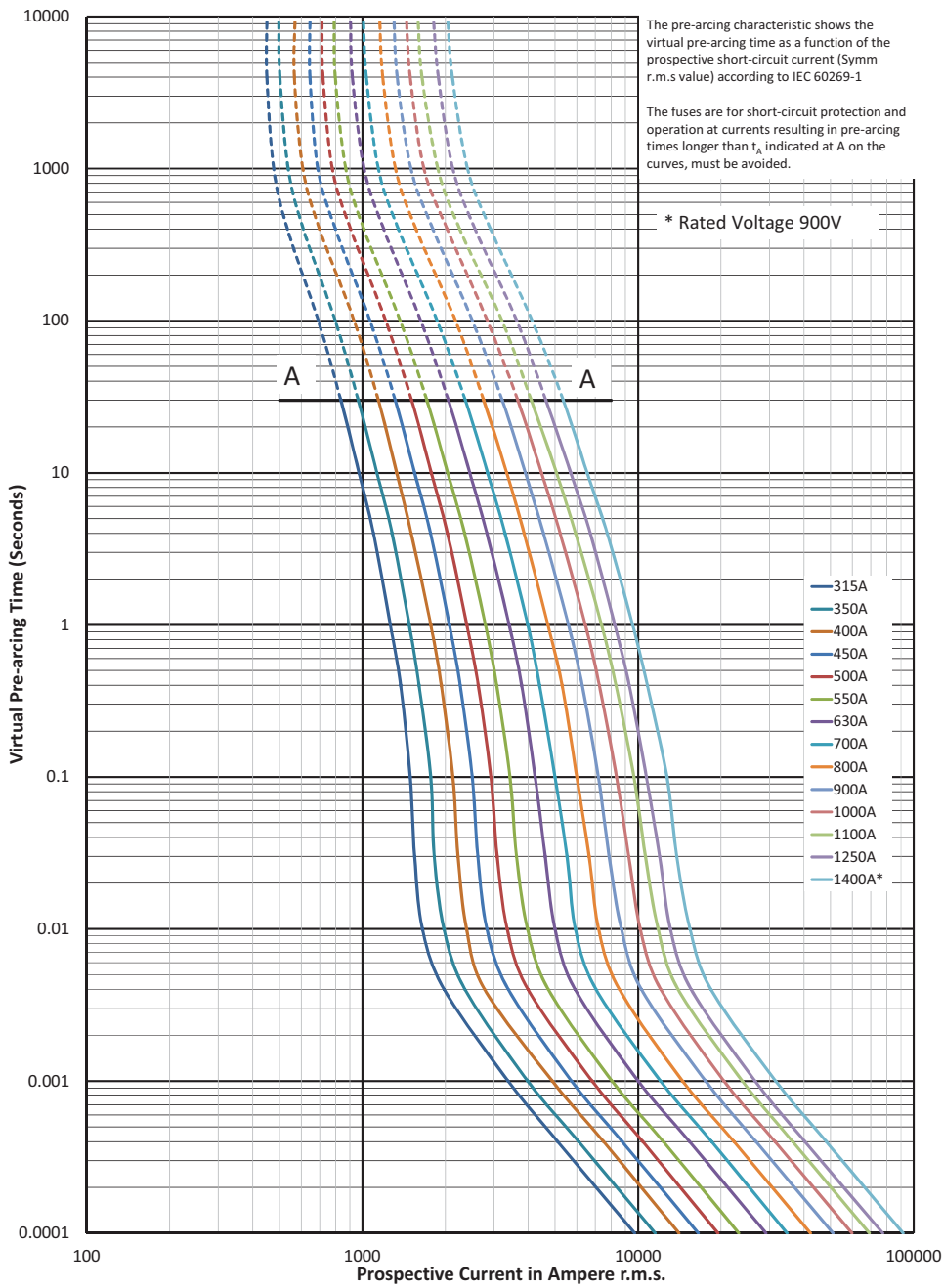

# Square body fuse links

## 170M - Sizes 1\* to 3, DIN 43653, 1000 V a.c. (IEC and UL), 50 A to 1400 A

### Cut-off curve - Size 3, 315 A to 1400 A

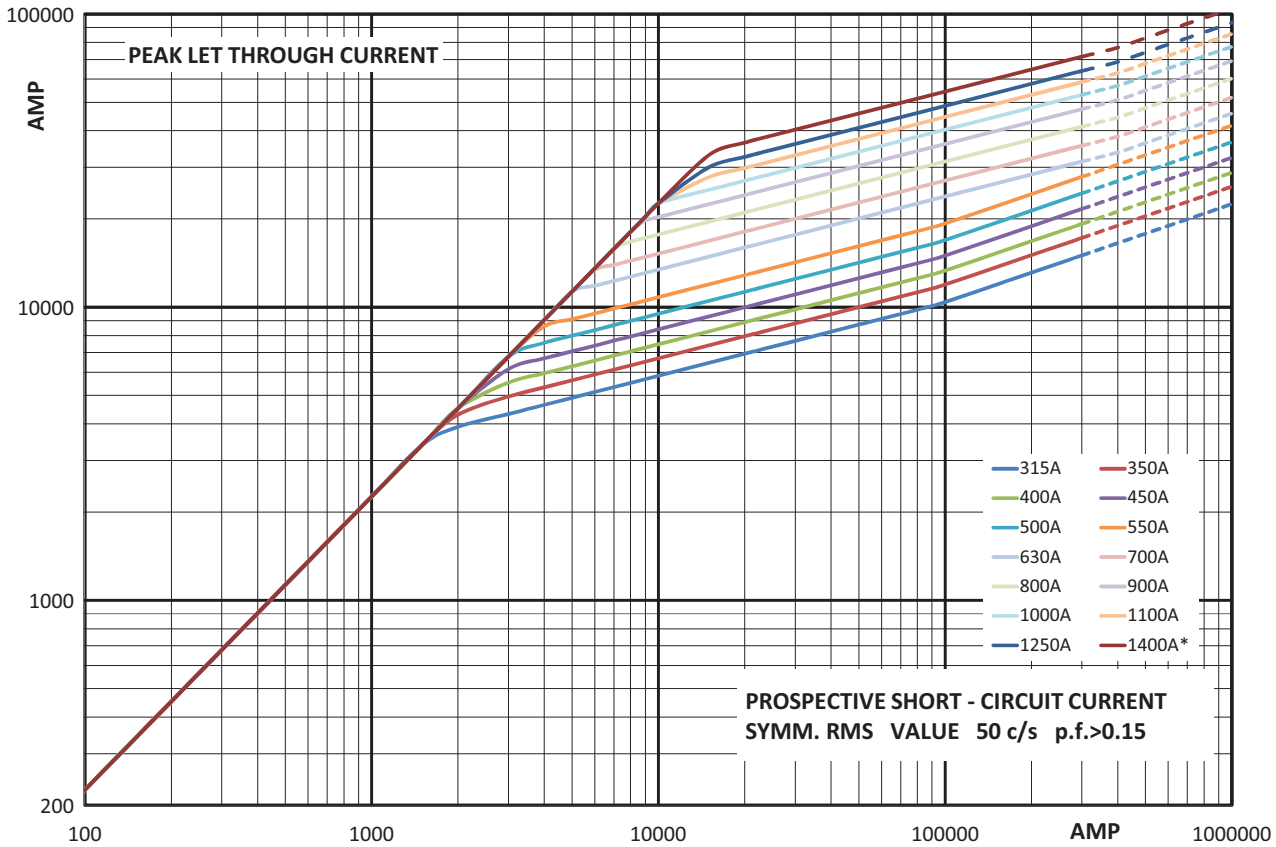

### Total clearing I<sup>2</sup>t

The total clearing I<sup>2</sup>t at rated voltage and at a power factor of 15 percent are given in the electrical characteristics. For other voltages, the clearing I<sup>2</sup>t is found by multiplying by correction factor, K, given as a function of applied working voltage, E<sub>g</sub>, (RMS).

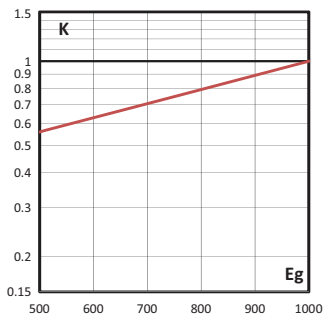

### Arc voltage

This curve gives the peak arc voltage, U<sub>L</sub>, which may appear across the fuse during its operation as a function of the applied working voltage, E<sub>g</sub>, (RMS) at a power factor of 15 percent.

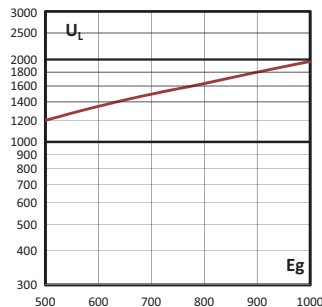

### Watts losses

Watts loss at rated current is given in the electrical characteristics. The curve allows the calculation of the watts losses at load currents lower than the rated current. The correction factor, K<sub>p</sub>, is given as a function of the RMS load current, I<sub>b</sub>, in percent of the rated current.

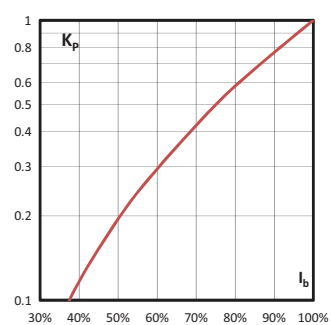



## 170M - Sizes 1\* to 3, DIN 43653, 1250 V a.c. (IEC), 1300 V a.c. (UL), 50 A to 1400 A

### Specifications

#### Description

Square body DIN 43653 bolted tags high speed fuse links, for the protection of DC common bus, DC drives, power converters/rectifiers and reduced rated voltage starters.

#### Technical data

- Rated voltage: see table opposite page
- Rated current: 50 A to 1400 A
- Breaking capacity: 100 kA RMS Sym.
- Operating class: aR

#### Standards / Agency information

CE, Designed and tested to IEC60269 Part 4. Consult Eaton for UL Recognition/CSA Component Acceptance status.



#### Dimensions (mm) -110 and TN/110

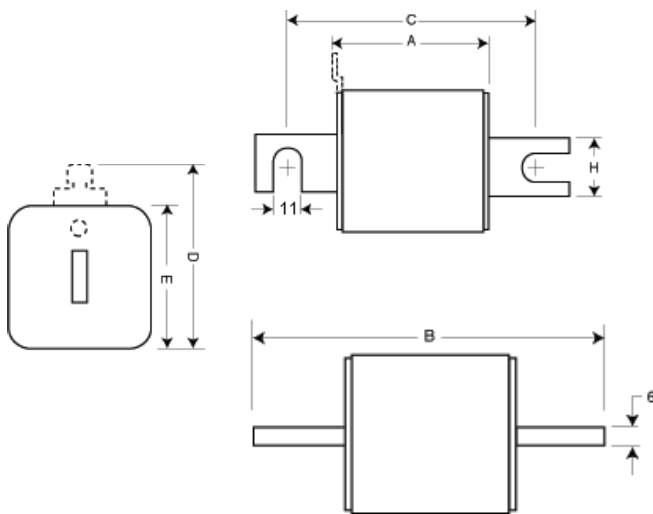

Size	A	B	C	D <sup>1</sup>	E	H	K
1*	80	138	108	58	45	20	11
1	80	138	108	66	53	25	11
2	80	138	108	75	61	25	11
3	81	139	108	90	76	30	11

<sup>1</sup> Clip on Microswitch valid for fuse links -TN//110.  
1mm = 0.0394"

#### Dimensions (mm) - KN/110

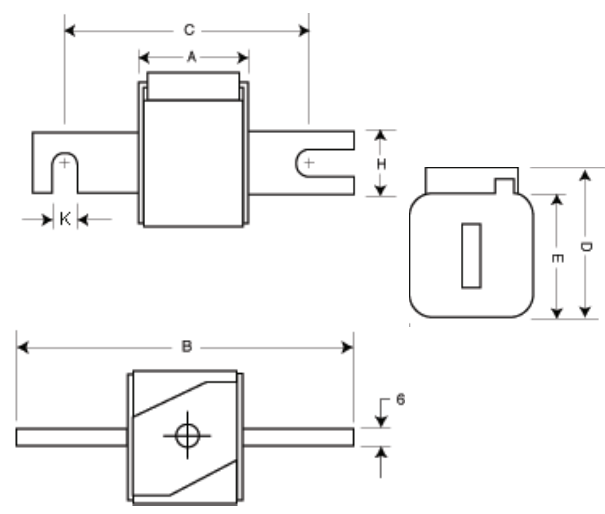

Size	A	B	C	D	E	H	K
1*	80	138	108	60	45	20	11
1	80	138	108	69	53	25	11
2	80	138	108	77	61	25	11
3	81	139	108	92	76	30	11

1mm = 0.0394"

# Square body fuse links

## 170M - Sizes 1\* to 3, DIN 43653, 1250 V a.c. (IEC), 1300 V a.c. (UL), 50 A to 1400 A

### Catalogue numbers

Fuse link body size	Rated voltage	Rated current (Amps)	I <sup>2</sup> t (A <sup>2</sup> Sec)			Watts loss (W)	Catalogue numbers		
			Pre-arcing	Clearing at 1000 V a.c.	Clearing at 1250 V a.c.		-/110 Visual indicator	-TN/110 Type T indicator for micro	-KN/110 Type K indicator for micro
1*	1250 V a.c. (IEC) 1300 V a.c. (UL)	50	135	815	1100	15	170M3138	170M3188	170M3238
		63	215	1300	1750	20	170M3139	170M3189	170M3239
		80	420	2500	3350	25	170M3140	170M3190	170M3240
		100	750	4450	5950	30	170M3141	170M3191	170M3241
		125	1450	9000	11,500	35	170M3142	170M3192	170M3242
		160	2600	16,000	21,000	40	170M3143	170M3193	170M3243
		200	5150	31,000	41,000	45	170M3144	170M3194	170M3244
		250	9200	54,500	73,000	55	170M3145	170M3195	170M3245
		315	18,500	115,000	150,000	60	170M3146	170M3196	170M3246
		350	27,000	165,000	220,000	65	170M3147	170M3197	170M3247
1	1250 V a.c. (IEC) 1300 V a.c. (UL)	400	53,000	265,000	335,000	70	170M3148	170M3198	170M3248
		160	1900	11,500	15,500	45	170M4138 <sup>2</sup>	170M4188 <sup>2</sup>	170M4238 <sup>2</sup>
		200	3800	22,500	30,000	50	170M4139 <sup>2</sup>	170M4189 <sup>2</sup>	170M4239 <sup>2</sup>
		250	7750	46,000	61,500	60	170M4140 <sup>2</sup>	170M4190 <sup>2</sup>	170M4240 <sup>2</sup>
		315	15,000	90,000	120,000	65	170M4141 <sup>2</sup>	170M4191 <sup>2</sup>	170M4241 <sup>2</sup>
		350	20,000	125,000	165,000	70	170M4142 <sup>2</sup>	170M4192 <sup>2</sup>	170M4242 <sup>2</sup>
		400	29,500	175,000	235,000	75	170M4143 <sup>2</sup>	170M4193 <sup>2</sup>	170M4243 <sup>2</sup>
		450	42,000	250,000	335,000	80	170M4144 <sup>2</sup>	170M4194 <sup>2</sup>	170M4244 <sup>2</sup>
		500	69,500	340,000	435,000	85	170M4145	170M4195	170M4245
		550	95,000	465,000	590,000	95	170M4146	170M4196	170M4246
2	1250 V a.c. (IEC) 1300 V a.c. (UL)	630	130,000	660,000	N/A	100	170M4147 <sup>1</sup>	170M4197 <sup>1</sup>	170M4247 <sup>1</sup>
		250	6500	38,500	51,500	65	170M5138	170M5188	170M5238
		280	9350	55,500	74,500	70	170M5139	170M5189	170M5239
		315	13,000	77,500	105,000	75	170M5140	170M5190	170M5240
		350	16,500	97,500	135,000	80	170M5141	170M5191	170M5241
		400	23,000	140,000	180,000	85	170M5142	170M5192	170M5242
		450	34,000	205,000	270,000	90	170M5143	170M5193	170M5243
		500	48,000	285,000	380,000	95	170M5144	170M5194	170M5244
		550	62,000	370,000	495,000	100	170M5145	170M5195	170M5245
		630	115,000	575,000	730,000	120	170M5146 <sup>2</sup>	170M5196 <sup>2</sup>	170M5246
3	1300 V a.c. (UL)	700	160,000	795,000	1,050,000	125	170M5147 <sup>2</sup>	170M5197 <sup>2</sup>	170M5247
		800	245,000	1,200,000	1,550,000	130	170M5148 <sup>2</sup>	170M5198 <sup>2</sup>	170M5248
		900	360,000	1,750,000	N/A	135	170M5149 <sup>4</sup>	170M5199 <sup>4</sup>	170M5249 <sup>4</sup>
		1000	480,000	2,350,000	N/A	145	170M5150 <sup>4</sup>	170M5200 <sup>4</sup>	170M5250 <sup>4</sup>
		315	9500	58,000	77,500	85	170M6138 <sup>2</sup>	170M6188 <sup>2</sup>	170M6238 <sup>2</sup>
		350	13,500	81,500	110,000	90	170M6139 <sup>2</sup>	170M6189 <sup>2</sup>	170M6239 <sup>2</sup>
		400	19,500	120,000	160,000	95	170M6140 <sup>2</sup>	170M6190 <sup>2</sup>	170M6240 <sup>2</sup>
		450	31,000	185,000	245,000	100	170M6141 <sup>2</sup>	170M6191 <sup>2</sup>	170M6241 <sup>2</sup>
		500	39,000	235,000	310,000	105	170M6142 <sup>2</sup>	170M6192 <sup>2</sup>	170M6242 <sup>2</sup>
		550	55,000	325,000	435,000	110	170M6143 <sup>2</sup>	170M6193 <sup>2</sup>	170M6243 <sup>2</sup>
3	1100 V a.c. (IEC)	630	83,500	495,000	665,000	115	170M6144 <sup>2</sup>	170M6194 <sup>2</sup>	170M6244 <sup>2</sup>
		700	115,000	705,000	940,000	120	170M6145 <sup>2</sup>	170M6195 <sup>2</sup>	170M6245 <sup>2</sup>
		800	205,000	995,000	1,300,000	125	170M6146 <sup>3</sup>	170M6196 <sup>3</sup>	170M6246 <sup>1</sup>
		900	305,000	1,500,000	1,900,000	130	170M6147 <sup>3</sup>	170M6197 <sup>3</sup>	170M6247 <sup>1</sup>
		1000	450,000	2,150,000	2,750,000	135	170M6148 <sup>3</sup>	170M6198 <sup>3</sup>	170M6248 <sup>1</sup>
		1100	575,000	2,800,000	3,600,000	160	170M6149 <sup>3</sup>	170M6199 <sup>3</sup>	170M6249 <sup>1</sup>
		1250	810,000	3,950,000	N/A	170	170M6150 <sup>5</sup>	170M6200 <sup>1</sup>	170M6250 <sup>1</sup>
		1400	1,250,000	6,000,000	N/A	175	170M6151 <sup>5</sup>	170M6201 <sup>1</sup>	170M6251 <sup>1</sup>

<sup>1</sup> These fuse links are not UL recognised

<sup>2</sup> 900 V d.c. 8XIn 90 kA

<sup>3</sup> Rated at 1000 V d.c. 10XIn 91 kA

<sup>4</sup> 900 V d.c. 9.5XIn 80 kA

<sup>5</sup> 900 V d.c. 12XIn 90 kA

Data sheets: 170K6630 (Size 1\*), 170K6632 (Size 1), 170K6634 (Size 2), 170K6636 (Size 3)

**170M - Sizes 1\* to 3, DIN 43653, 1250 V a.c. (IEC), 1300 V a.c. (UL), 50 A to 1400 A**

Time-current curve - Size 1\*, 50 A to 400 A

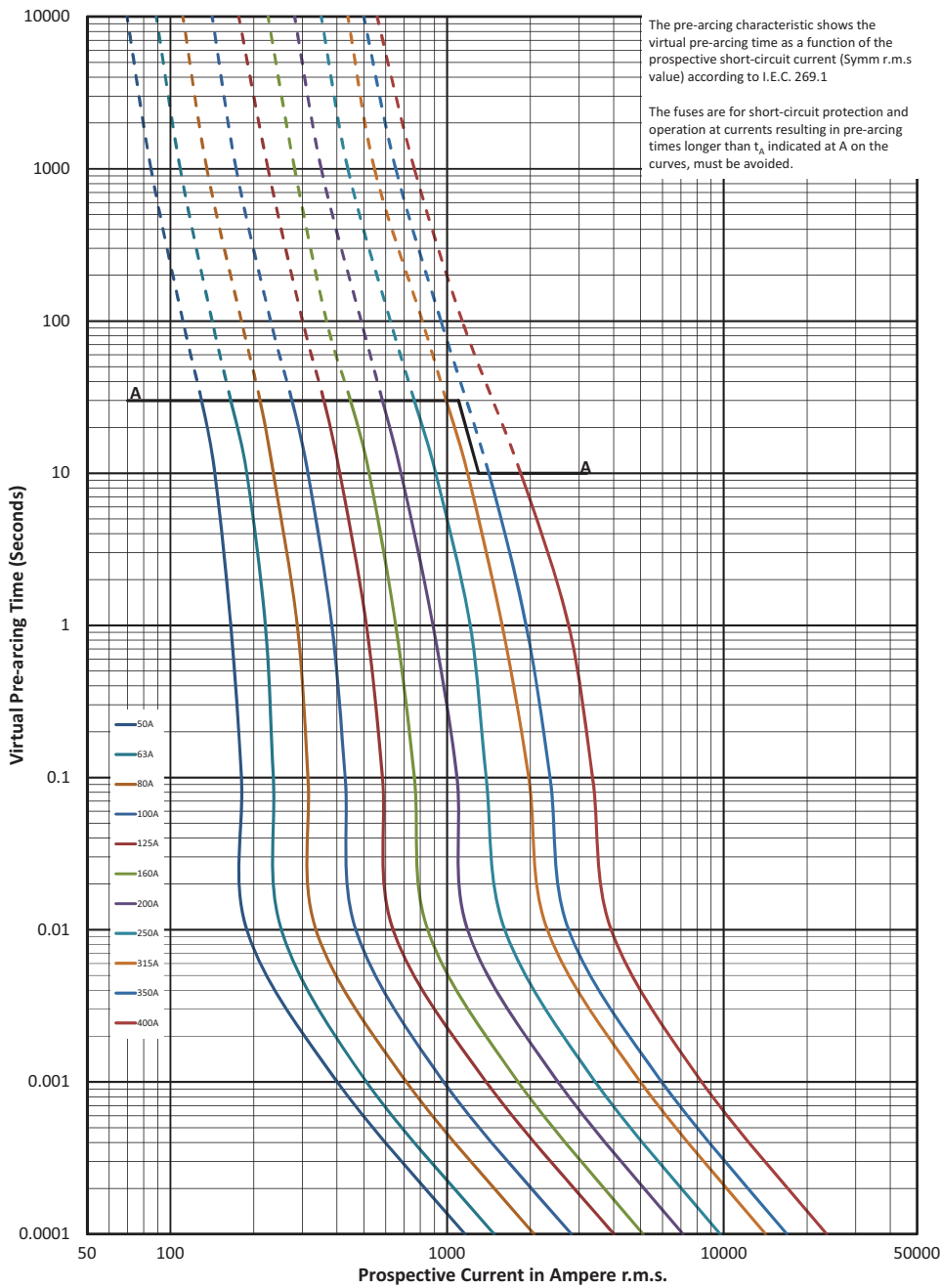

# Square body fuse links

170M - Sizes 1\* to 3, DIN 43653, 1250 V a.c. (IEC), 1300 V a.c. (UL), 50 A to 1400 A

Cut-off curve - Size 1\*, 50 A to 400 A

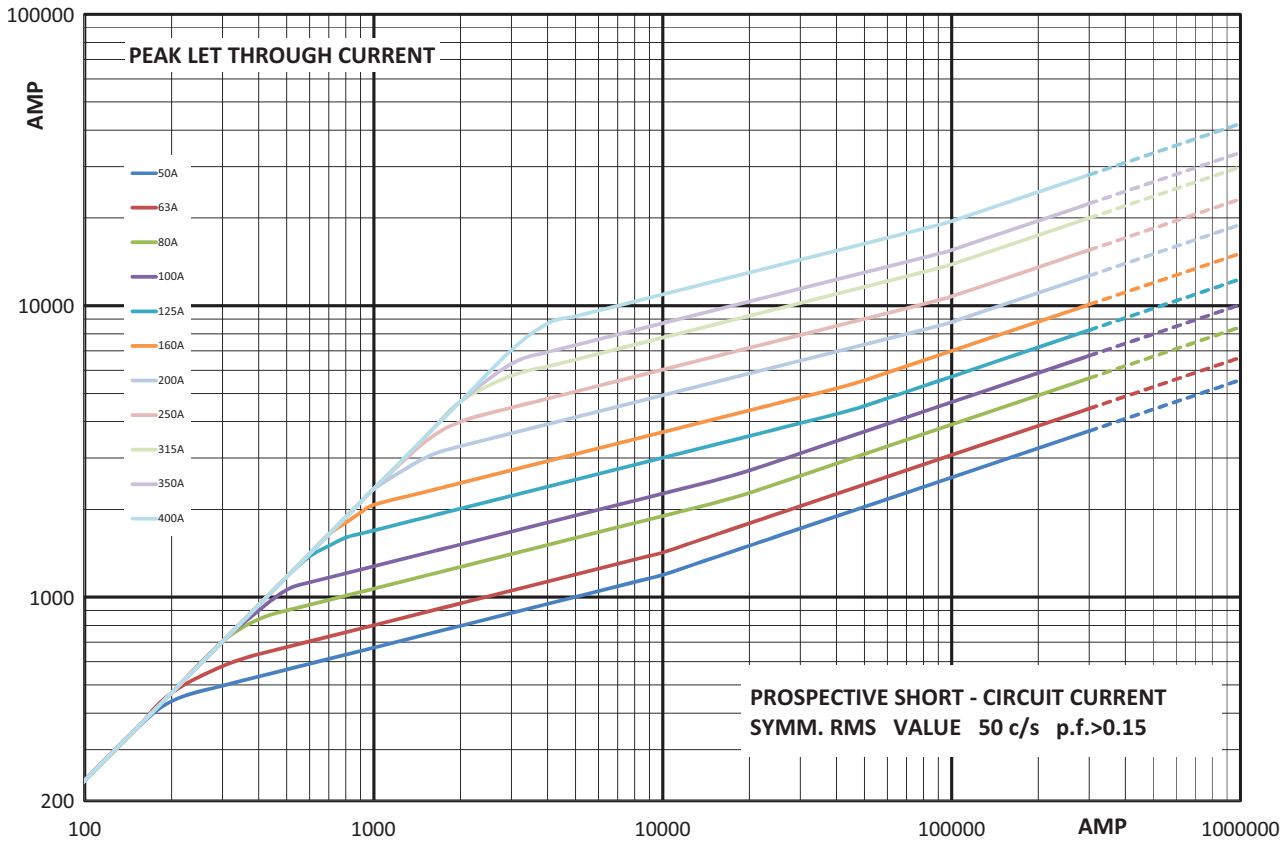

## Total clearing $I^2t$

The total clearing  $I^2t$  at rated voltage and at a power factor of 15 percent are given in the electrical characteristics. For other voltages, the clearing  $I^2t$  is found by multiplying by correction factor,  $K$ , given as a function of applied working voltage,  $E_g$ , (RMS).

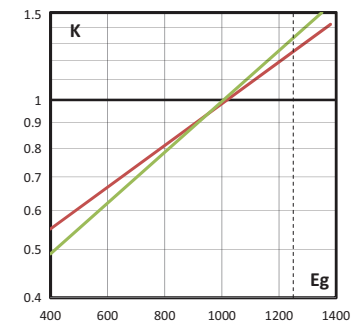

Green curve: fuses  $\leq 350$  A

Red curve: fuses  $\geq 400$  A

## Arc voltage

This curve gives the peak arc voltage,  $U_L$ , which may appear across the fuse during its operation as a function of the applied working voltage,  $E_g$ , (RMS) at a power factor of 15 percent.

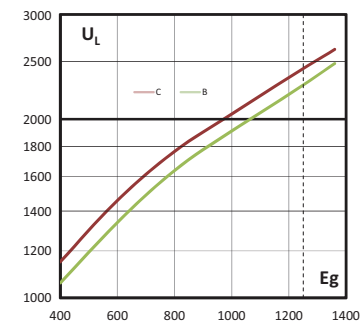

B: fuses  $\leq 350$  A

C: fuses  $\geq 400$  A

## Watts losses

Watts loss at rated current is given in the electrical characteristics. The curve allows the calculation of the watts losses at load currents lower than the rated current. The correction factor,  $K_p$ , is given as a function of the RMS load current,  $I_b$ , in percent of the rated current.

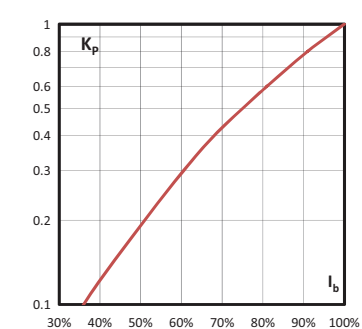

**170M** - Sizes 1\* to 3, DIN 43653, 1250 V a.c. (IEC), 1300 V a.c. (UL), 50 A to 1400 A

Time-current curve - Size 1, 160 A to 630 A

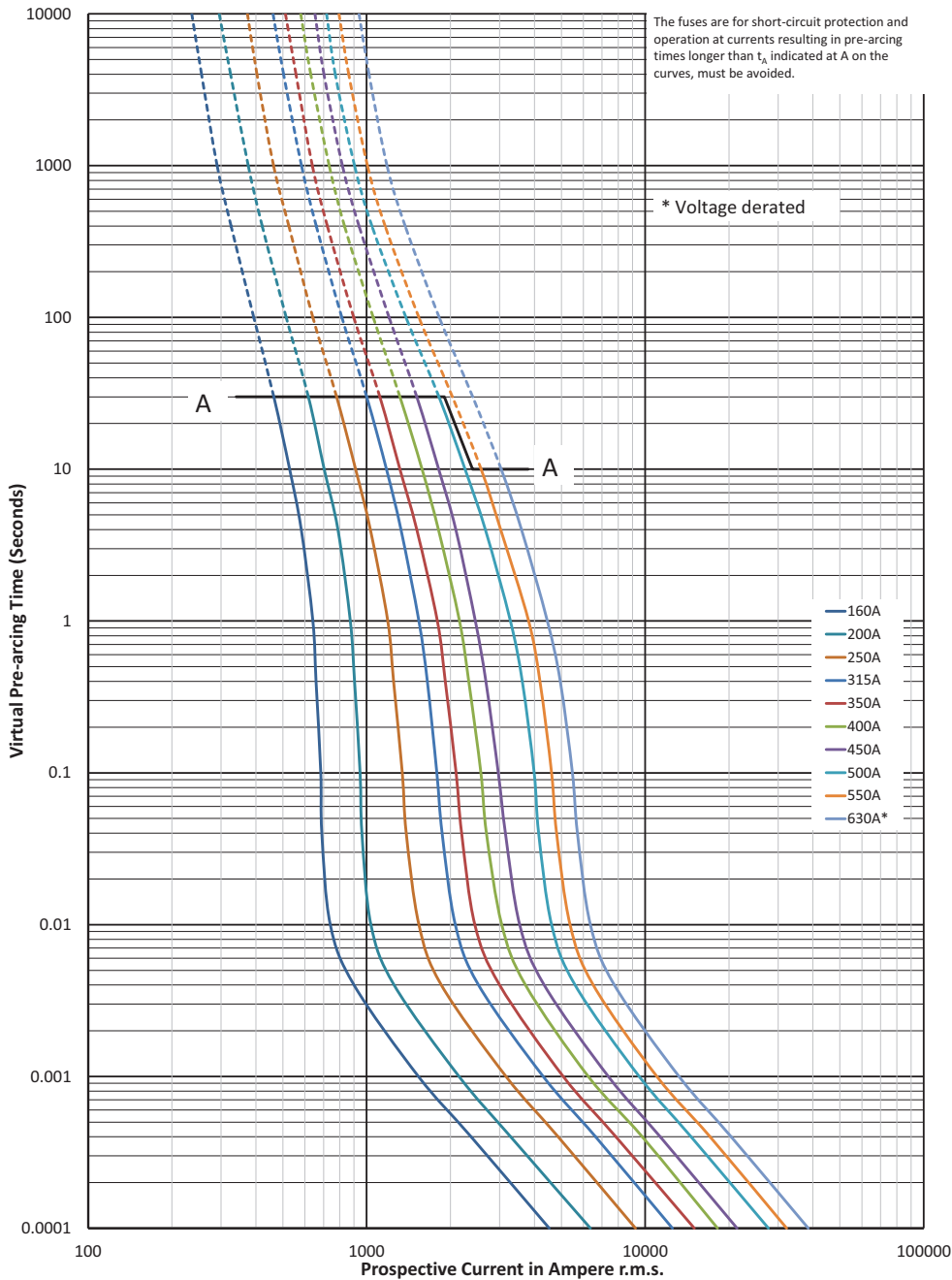

# Square body fuse links

**170M** - Sizes 1\* to 3, DIN 43653, 1250 V a.c. (IEC), 1300 V a.c. (UL), 50 A to 1400 A

Cut-off curve - Size 1, 160 A to 630 A

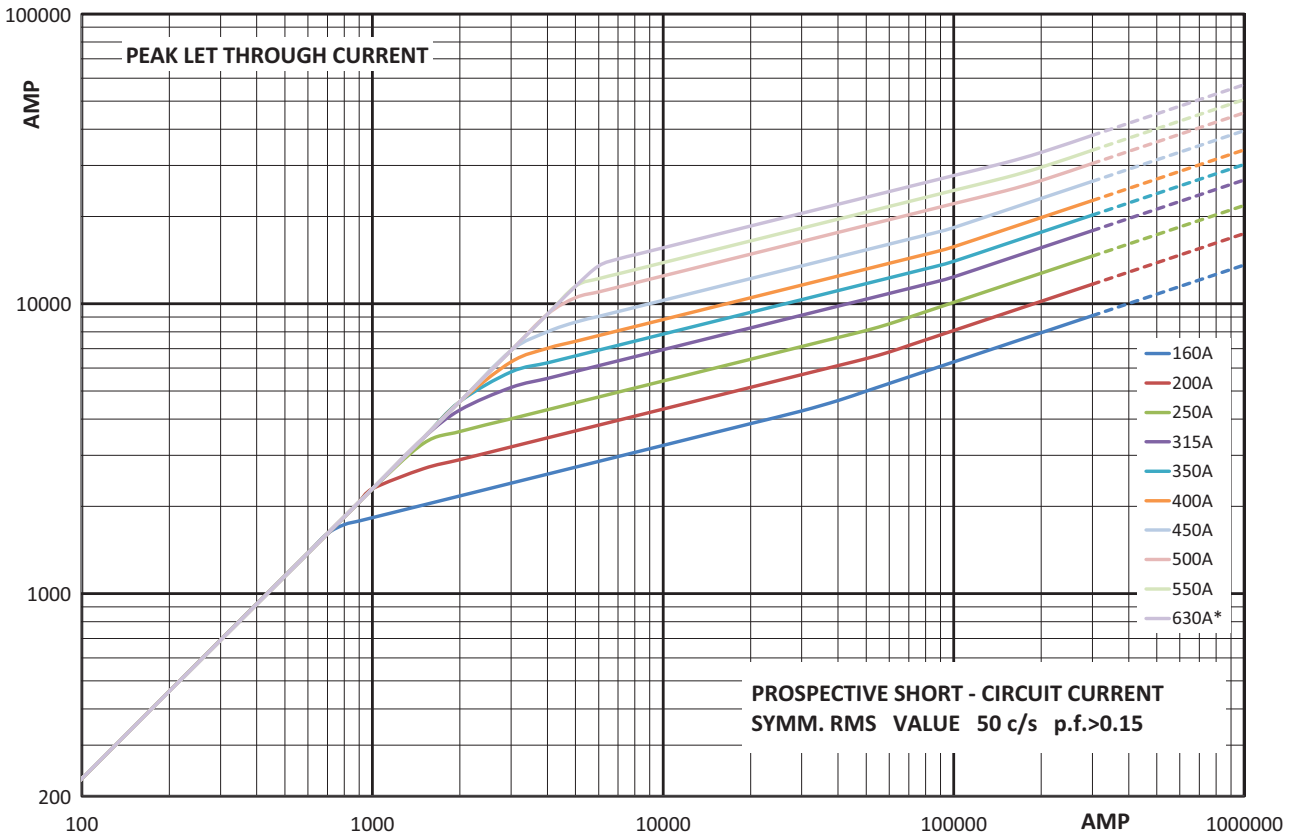

## Total clearing $I^2t$

The total clearing  $I^2t$  at rated voltage and at a power factor of 15 percent are given in the electrical characteristics. For other voltages, the clearing  $I^2t$  is found by multiplying by correction factor,  $K$ , given as a function of applied working voltage,  $E_g$ , (RMS).

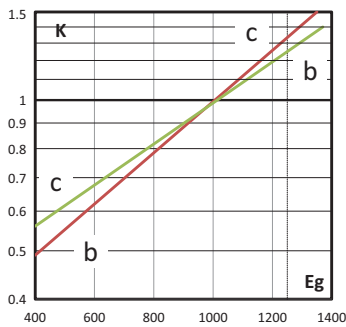

B: fuses ≤ 450 A  
C: fuses ≥ 500 A

## Arc voltage

This curve gives the peak arc voltage,  $U_L$ , which may appear across the fuse during its operation as a function of the applied working voltage,  $E_g$ , (RMS) at a power factor of 15 percent.

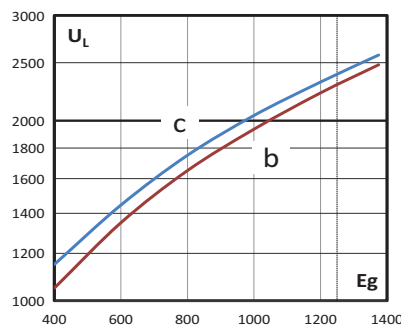

B: fuses ≤ 450 A  
C: fuses ≥ 500 A

## Watts losses

Watts loss at rated current is given in the electrical characteristics. The curve allows the calculation of the watts losses at load currents lower than the rated current. The correction factor,  $K_p$ , is given as a function of the RMS load current,  $I_b$ , in percent of the rated current.

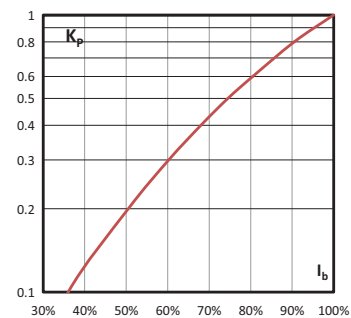

**170M** - Sizes 1\* to 3, DIN 43653, 1250 V a.c. (IEC), 1300 V a.c. (UL), 50 A to 1400 A

Time-current curve - Size 2, 250 A to 1000 A

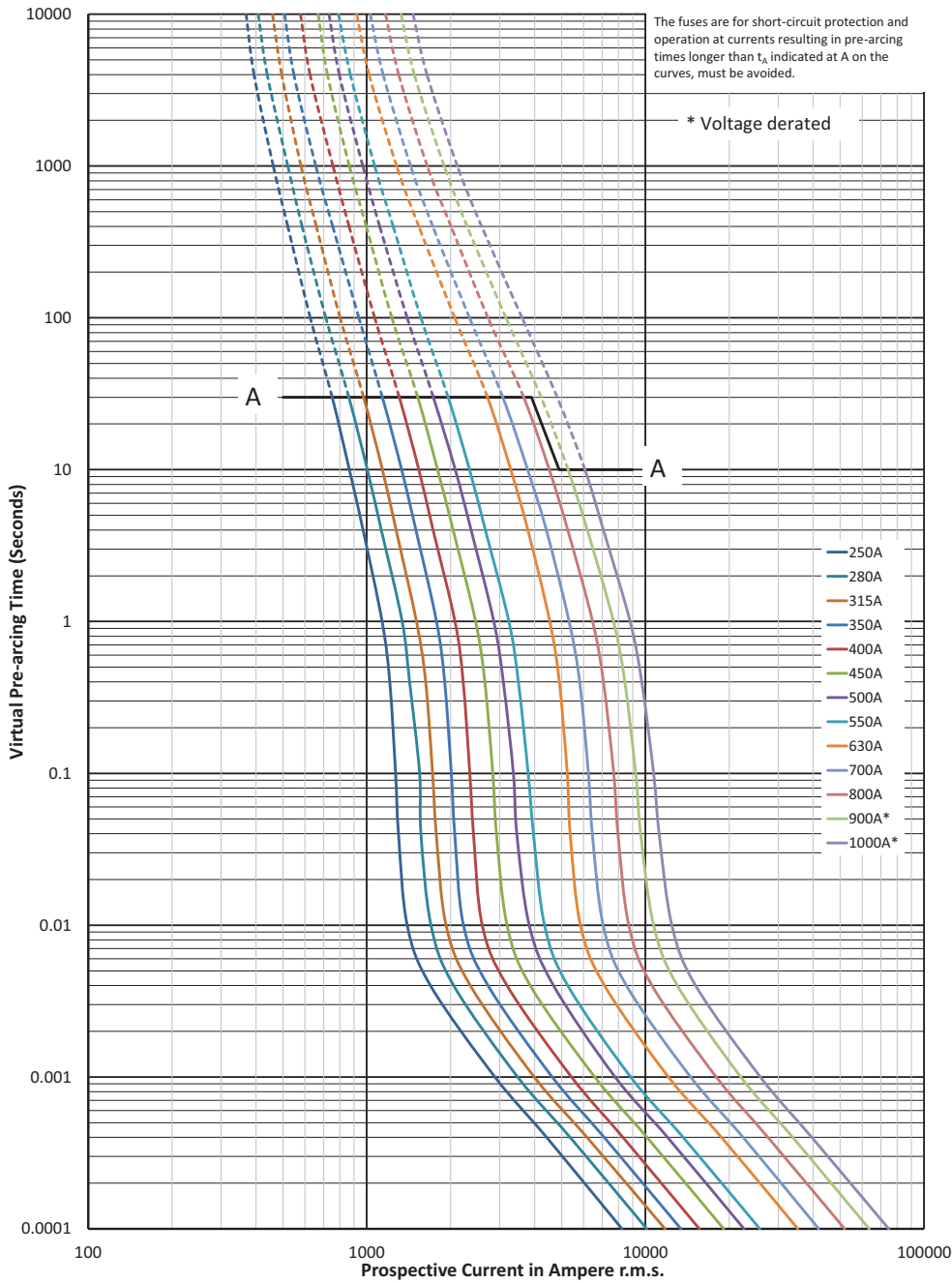

# Square body fuse links

## 170M - Sizes 1\* to 3, DIN 43653, 1250 V a.c. (IEC), 1300 V a.c. (UL), 50 A to 1400 A

### Cut-off curve - Size 2, 250 A to 1000 A

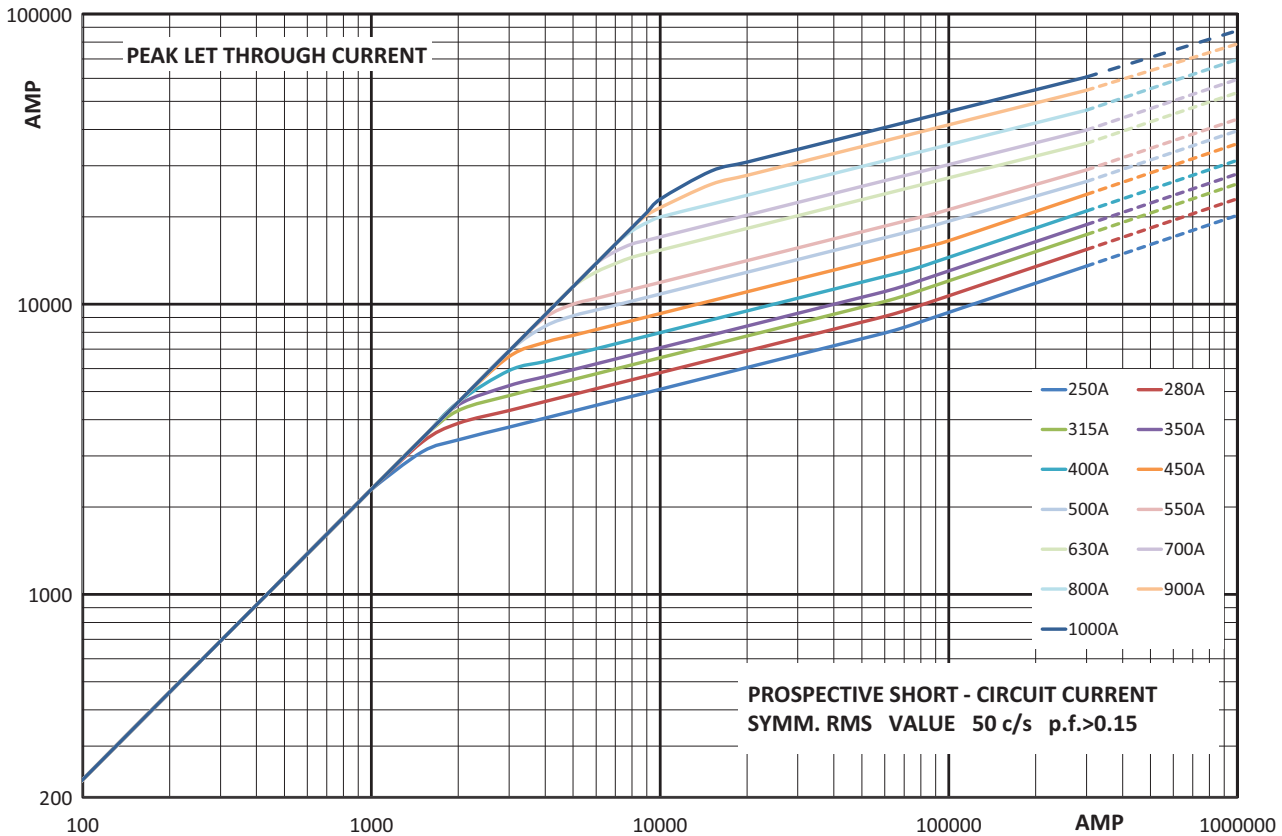

### Total clearing $I^2t$

The total clearing  $I^2t$  at rated voltage and at a power factor of 15 percent are given in the electrical characteristics. For other voltages, the clearing  $I^2t$  is found by multiplying by correction factor,  $K$ , given as a function of applied working voltage,  $E_g$  (RMS).

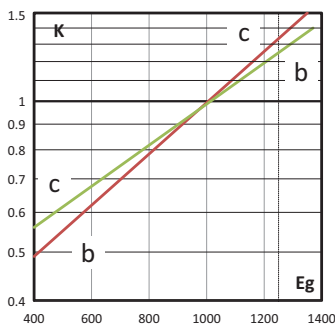

B: fuses  $\leq 550$  A

C: fuses  $\geq 630$  A

### Arc voltage

This curve gives the peak arc voltage,  $U_L$ , which may appear across the fuse during its operation as a function of the applied working voltage,  $E_g$  (RMS) at a power factor of 15 percent.

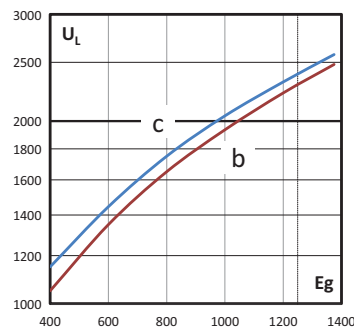

B: fuses  $\leq 550$  A

C: fuses  $\geq 630$  A

### Watts losses

Watts loss at rated current is given in the electrical characteristics. The curve allows the calculation of the watts losses at load currents lower than the rated current. The correction factor,  $K_p$ , is given as a function of the RMS load current,  $I_b$ , in percent of the rated current.

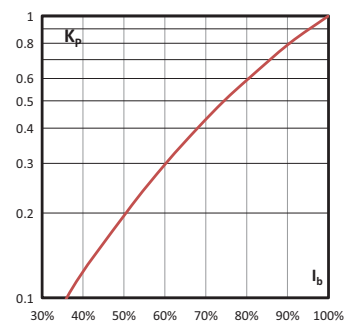



**170M** - Sizes 1\* to 3, DIN 43653, 1250 V a.c. (IEC), 1300 V a.c. (UL), 50 A to 1400 A

Time-current curve - Size 3, 315 A to 1400 A

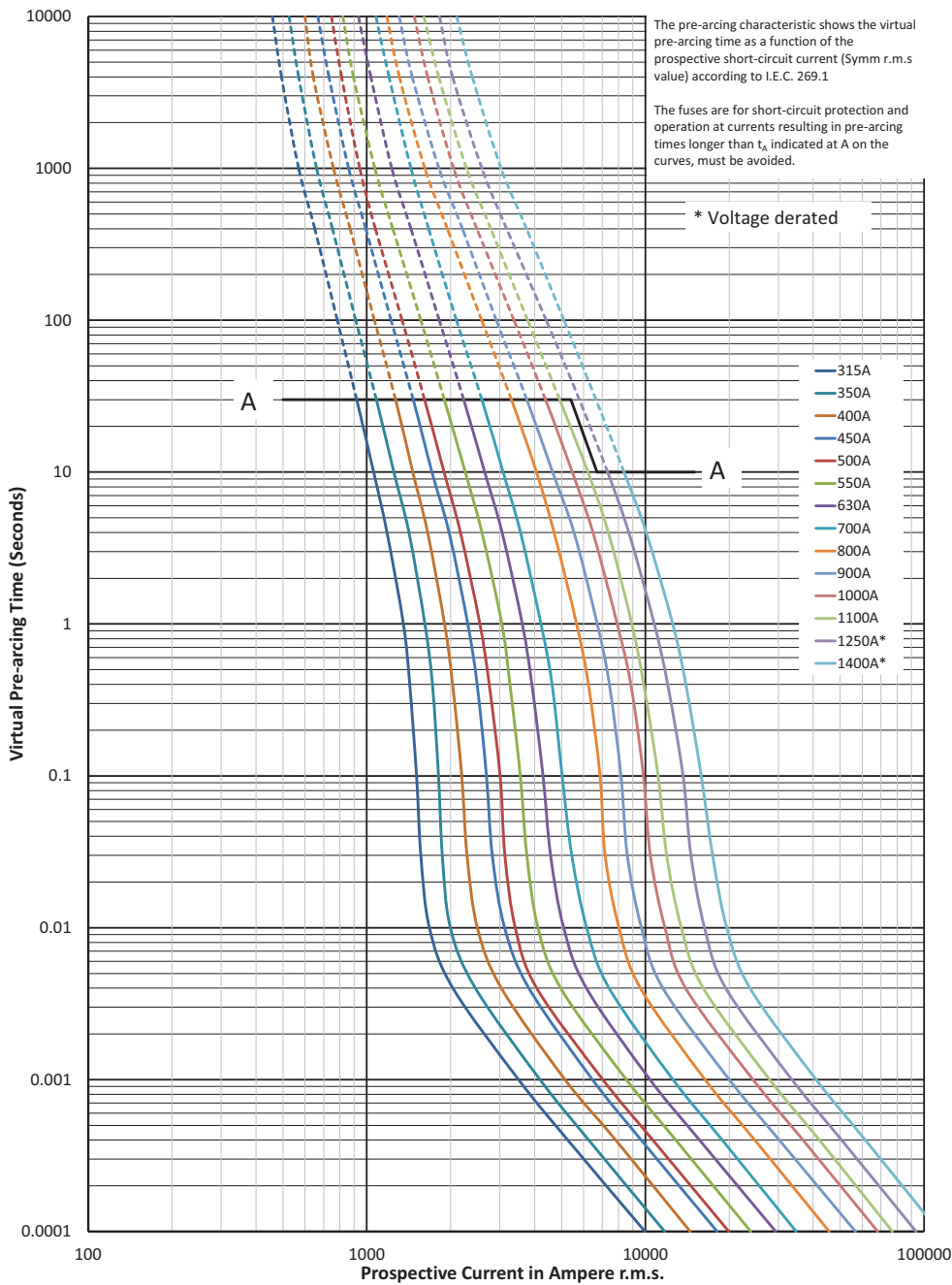

$K_b = 1$     $N = 1.6$

# Square body fuse links

## 170M - Sizes 1\* to 3, DIN 43653, 1250 V a.c. (IEC), 1300 V a.c. (UL), 50 A to 1400 A

### Cut-off curve - Size 3, 315 A to 1400 A

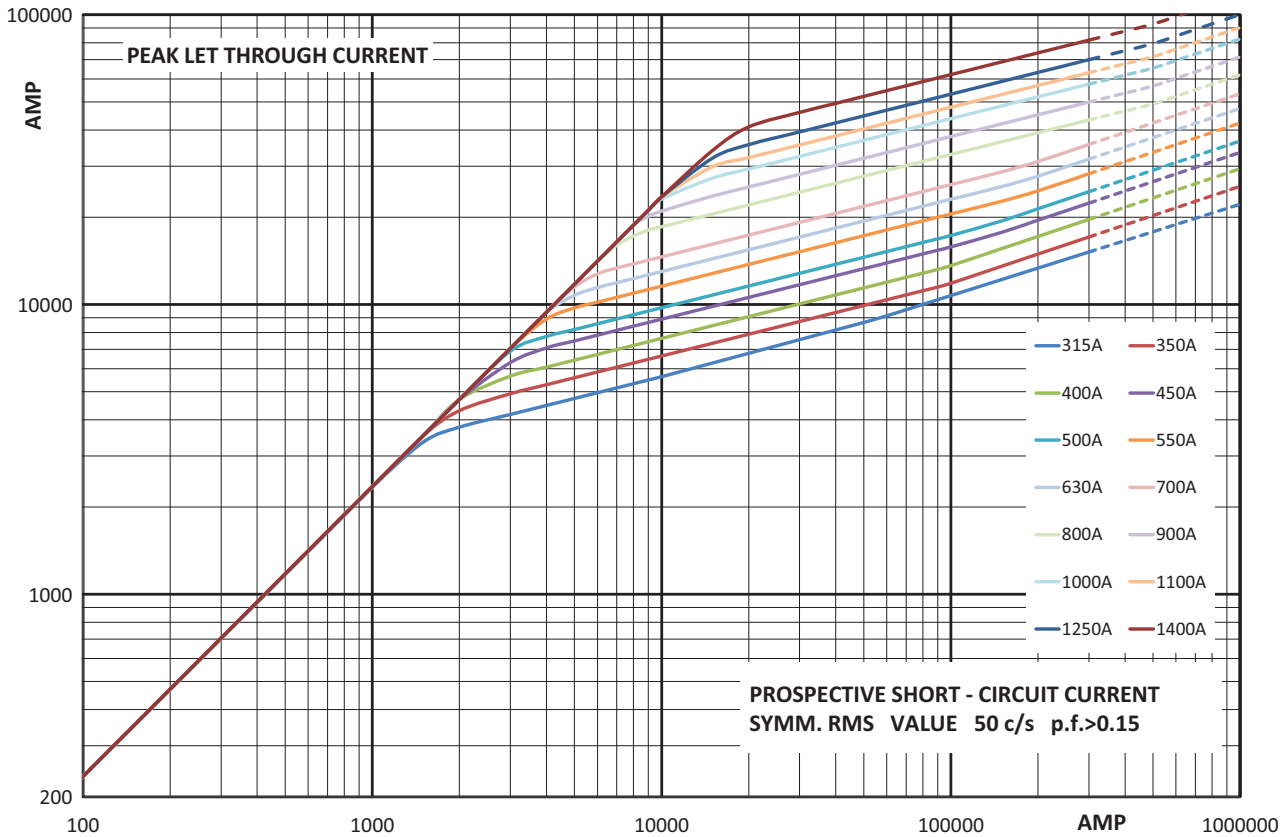

### Total clearing $I^2t$

The total clearing  $I^2t$  at rated voltage and at a power factor of 15 percent are given in the electrical characteristics. For other voltages, the clearing  $I^2t$  is found by multiplying by correction factor,  $K$ , given as a function of applied working voltage,  $E_g$  (RMS).

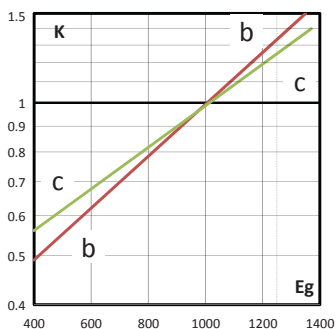

B: fuses  $\leq 550$  A  
C: fuses  $\geq 630$  A

### Arc voltage

This curve gives the peak arc voltage,  $U_L$ , which may appear across the fuse during its operation as a function of the applied working voltage,  $E_g$  (RMS) at a power factor of 15 percent.

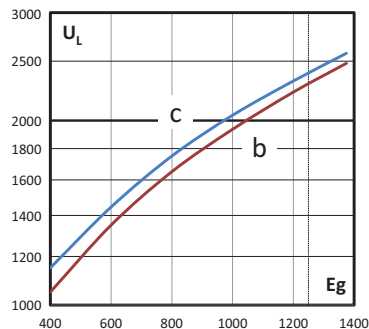

B: fuses  $\leq 700$  A  
C: fuses  $\geq 800$  A

### Watts losses

Watts loss at rated current is given in the electrical characteristics. The curve allows the calculation of the watts losses at load currents lower than the rated current. The correction factor,  $K_p$ , is given as a function of the RMS load current,  $I_b$ , in percent of the rated current.

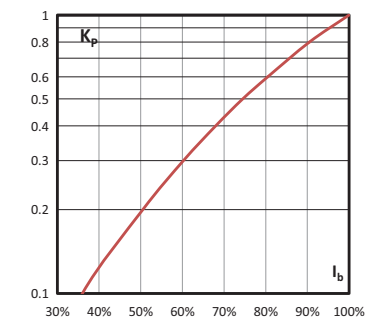

## 170M - Sizes 00 to 3, DIN 43620, Full range (gR), 690 V a.c. (IEC), 10 A to 800 A

### Specifications

#### Description

Square body DIN 43620 blade high speed fuse links. Full range protection fuse links provide both overload and short-circuit protection.

#### Technical data

- Rated voltage: 690 V a.c. (IEC)
- Rated current: 10 A to 800 A
- Breaking capacity: 200 kA RMS Sym
- Operating class: gR

#### Standards / Agency information

CE, Designed and tested to IEC 60269 Part 4



#### Dimensions (mm)

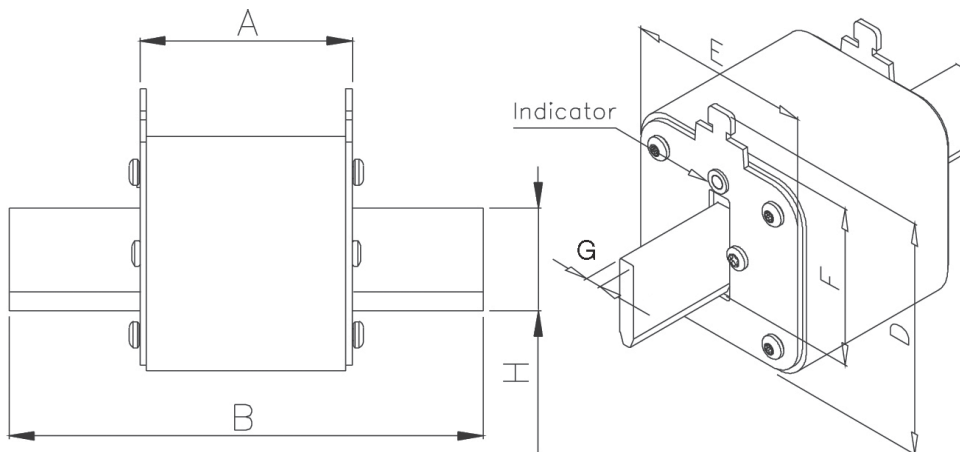

Size	A	B	D (max)	E (max)	F	G	H (min)
00	49	78.5	60	30	35	6	15
1	68	135	66	52	40	6	20
2	68	150	74	60	48	6	25
3	68	150	89	75	60	6	32

# Square body fuse links

## 170M - Sizes 00 to 3, DIN 43620, Full range (gR), 690 V a.c. (IEC), 10 A to 800 A

### Catalogue numbers

Fuse link body size	Rated voltage	Rated current (Amps) <sup>1</sup>	I <sup>2</sup> t (A <sup>2</sup> Sec)		Watts loss (W)	Catalogue numbers
			Pre-arcing	Clearing at 690 V a.c.		Type T indicator for micro
00	690 V a.c. (IEC)	10	3.8	20	3.5	170M2691
		16	7.2	38	5.5	170M2692
		20	13	70	6	170M2693
		25	24	125	8	170M2694
		32	53	275	9	170M2695
		40	95	490	10	170M2696
		50	185	1000	11	170M2697
		63	345	1800	14	170M2698
		80	695	3600	16	170M2699
		100	1250	6650	19	170M2700
		125	2300	12,000	23	170M2701
		160	4350	22,500	29	170M2702
1	690 V a.c. (IEC)	50	135	705	12	170M4176
		63	245	1300	15	170M4177
		80	500	2600	17	170M4178
		100	950	4850	20	170M4179
		125	1850	9500	23	170M4180
		160	3450	18,000	28	170M4181
		200	6750	34,500	31	170M4182
		250	13,500	70,500	35	170M4183
		315	26,000	135,000	41	170M4184
		350	34,000	175,000	45	170M4185
2	690 V a.c. (IEC)	400	48,500	250,000	48	170M4186
		200	5650	29,000	33	170M5881
		250	10,000	52,500	40	170M5882
		315	19,500	105,000	46	170M5883
		350	26,000	135,000	50	170M5884
		400	39,500	205,000	53	170M5885
		450	55,500	290,000	59	170M5886
		500	73,000	375,000	66	170M5887
3	690 V a.c. (IEC)	550	100,000	515,000	70	170M5888
		630	150,000	770,000	79	170M5889
		350	23,000	120,000	55	170M6080
		400	34,000	175,000	59	170M6081
		450	48,500	250,000	62	170M6082
		500	64,000	330,000	67	170M6083
		550	84,500	435,000	70	170M6084
		630	125,000	645,000	85	170M6085
700	160,000	840,000	93	170M6086		
800	245,000	1,300,000	99	170M6087		

<sup>1</sup> The RMS Amp rating of this fuse links range is given with open fuse bases connected to copper conductors according to IEC 60269-1, table 17. When used in enclosed fuse bases/disconnects, derating factors have to be observed. Please contact Eaton for application assistance [bulehighspeedtechnical@eaton.com](mailto:bulehighspeedtechnical@eaton.com).

**170M** - Sizes 00 to 3, DIN 43620, Full range (gR), 690 V a.c. (IEC), 10 A to 800 A

Time-current curve - Size 00, 10 A to 160 A

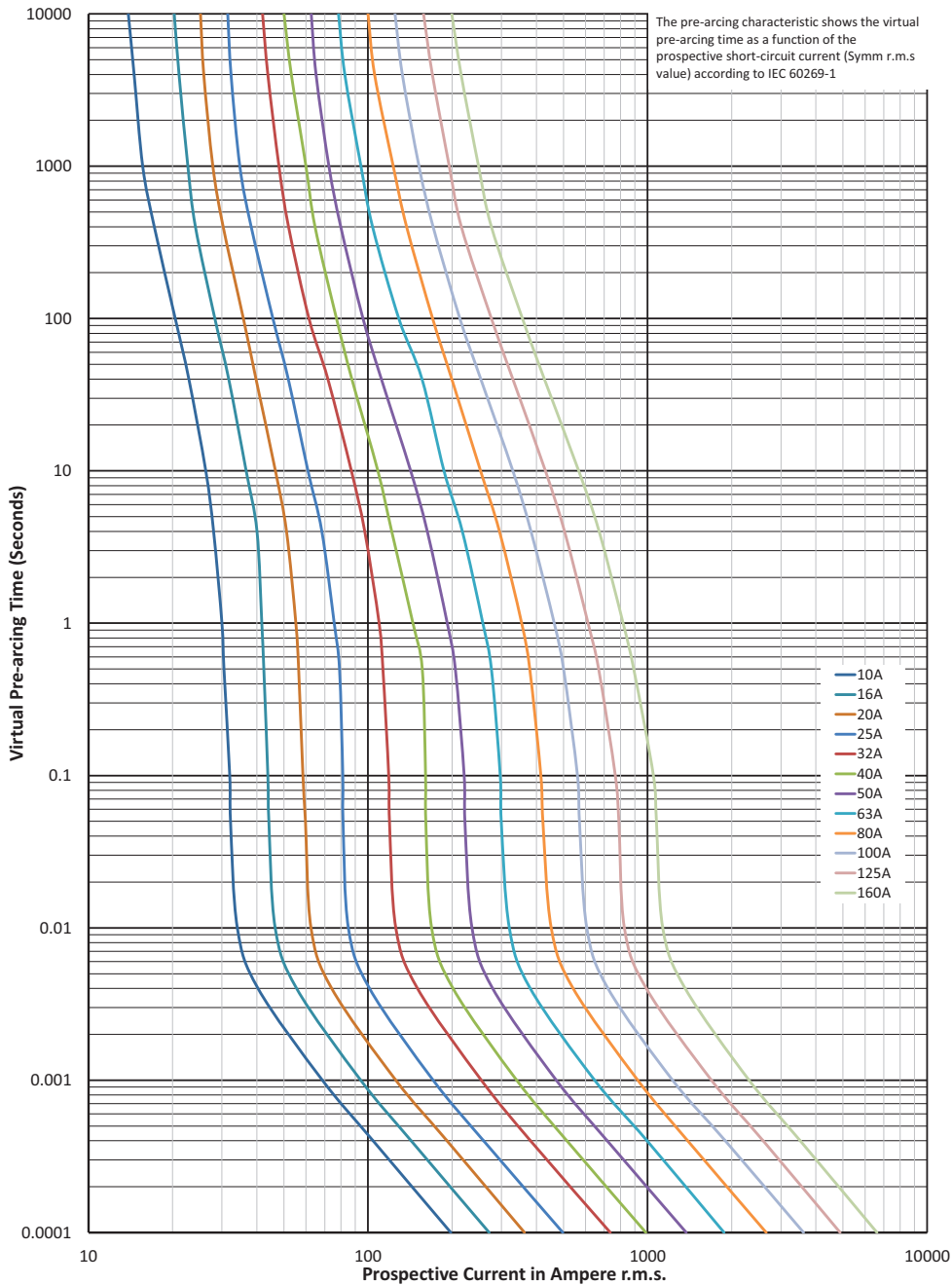

# Square body fuse links

## 170M - Sizes 00 to 3, DIN 43620, Full range (gR), 690 V a.c. (IEC), 10 A to 800 A

### Cut-off curve - Size 00, 10 A to 160 A

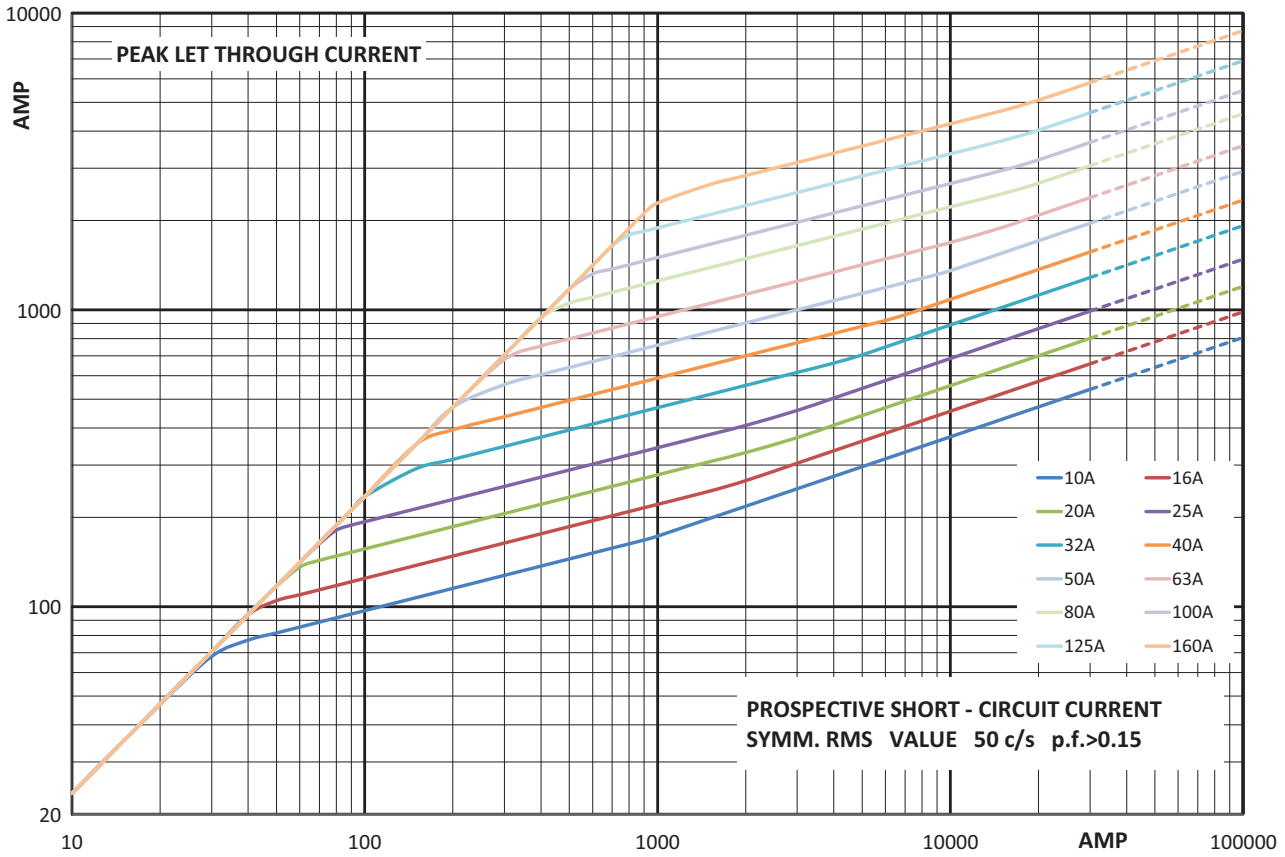

### Total clearing $I^2t$

The total clearing  $I^2t$  at rated voltage and at a power factor of 15 percent are given in the electrical characteristics. For other voltages, the clearing  $I^2t$  is found by multiplying by correction factor,  $K$ , given as a function of applied working voltage,  $E_g$ , (RMS).

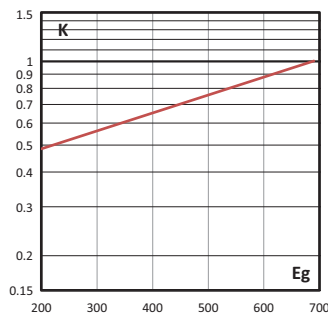

### Arc voltage

This curve gives the peak arc voltage,  $U_L$ , which may appear across the fuse during its operation as a function of the applied working voltage,  $E_g$ , (RMS) at a power factor of 15 percent.

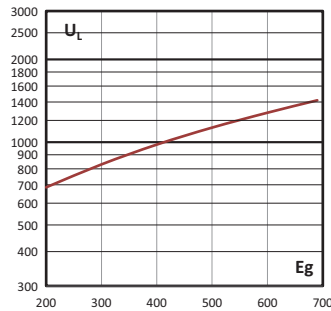

### Watts losses

Watts loss at rated current is given in the electrical characteristics. The curve allows the calculation of the watts losses at load currents lower than the rated current. The correction factor,  $K_p$ , is given as a function of the RMS load current,  $I_b$ , in percent of the rated current.

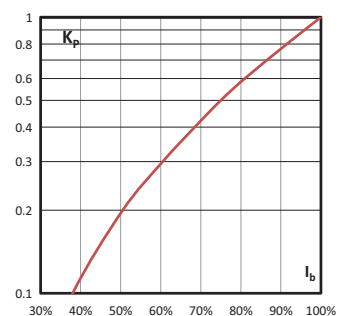

**170M** - Sizes 00 to 3, DIN 43620, Full range (gR), 690 V a.c. (IEC), 10 A to 800 A

Time-current curve - Size 1, 50 A to 400 A

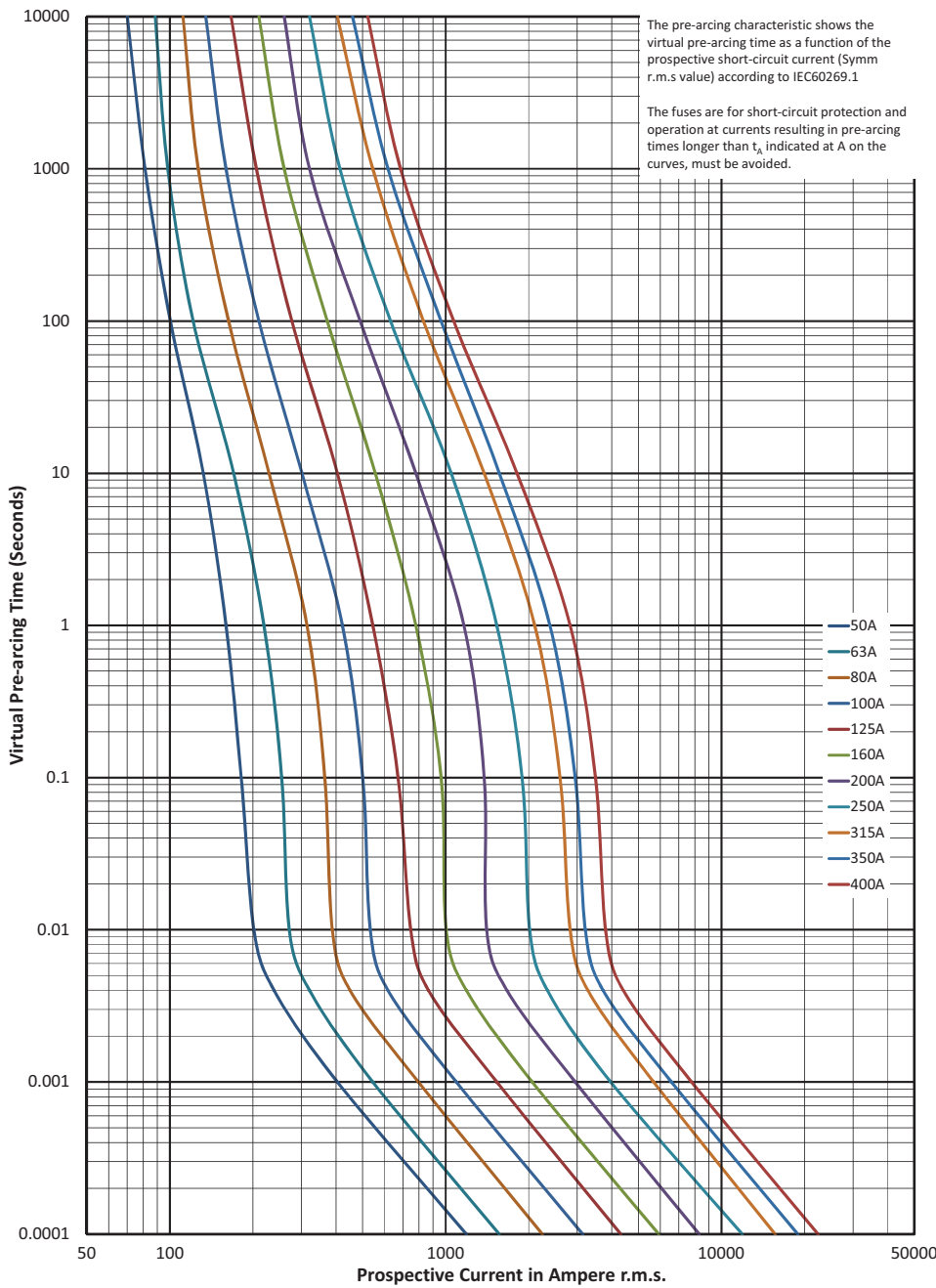

$K_b = 1$   $N = 1,6$

# Square body fuse links

## 170M - Sizes 00 to 3, DIN 43620, Full range (gR), 690 V a.c. (IEC), 10 A to 800 A

### Cut-off curve - Size 1, 50 A to 400 A

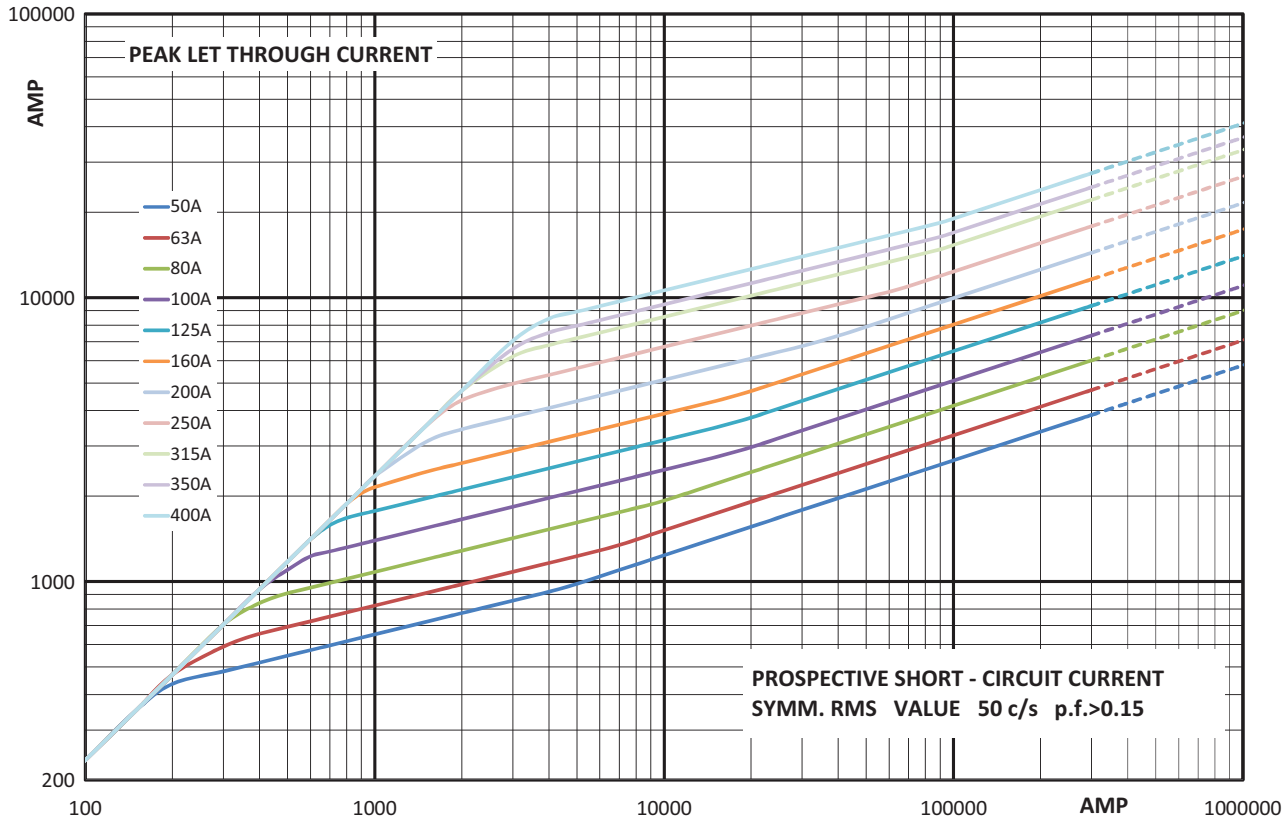

### Total clearing $I^2t$

The total clearing  $I^2t$  at rated voltage and at a power factor of 15 percent are given in the electrical characteristics. For other voltages, the clearing  $I^2t$  is found by multiplying by correction factor,  $K$ , given as a function of applied working voltage,  $E_g$ , (RMS).

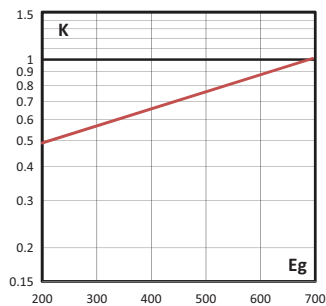

### Arc voltage

This curve gives the peak arc voltage,  $U_L$ , which may appear across the fuse during its operation as a function of the applied working voltage,  $E_g$ , (RMS) at a power factor of 15 percent.

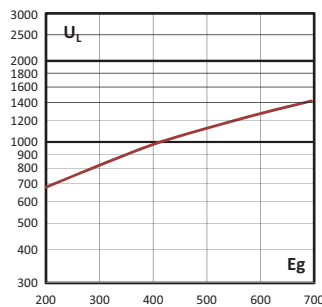

### Watts losses

Watts loss at rated current is given in the electrical characteristics. The curve allows the calculation of the watts losses at load currents lower than the rated current. The correction factor,  $K_p$ , is given as a function of the RMS load current,  $I_b$ , in percent of the rated current.

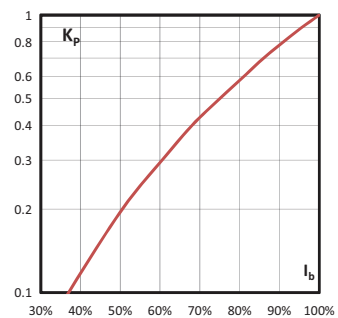



**170M** - Sizes 00 to 3, DIN 43620, Full range (gR), 690 V a.c. (IEC), 10 A to 800 A

Time-current curve - Size 2, 200 A to 630 A

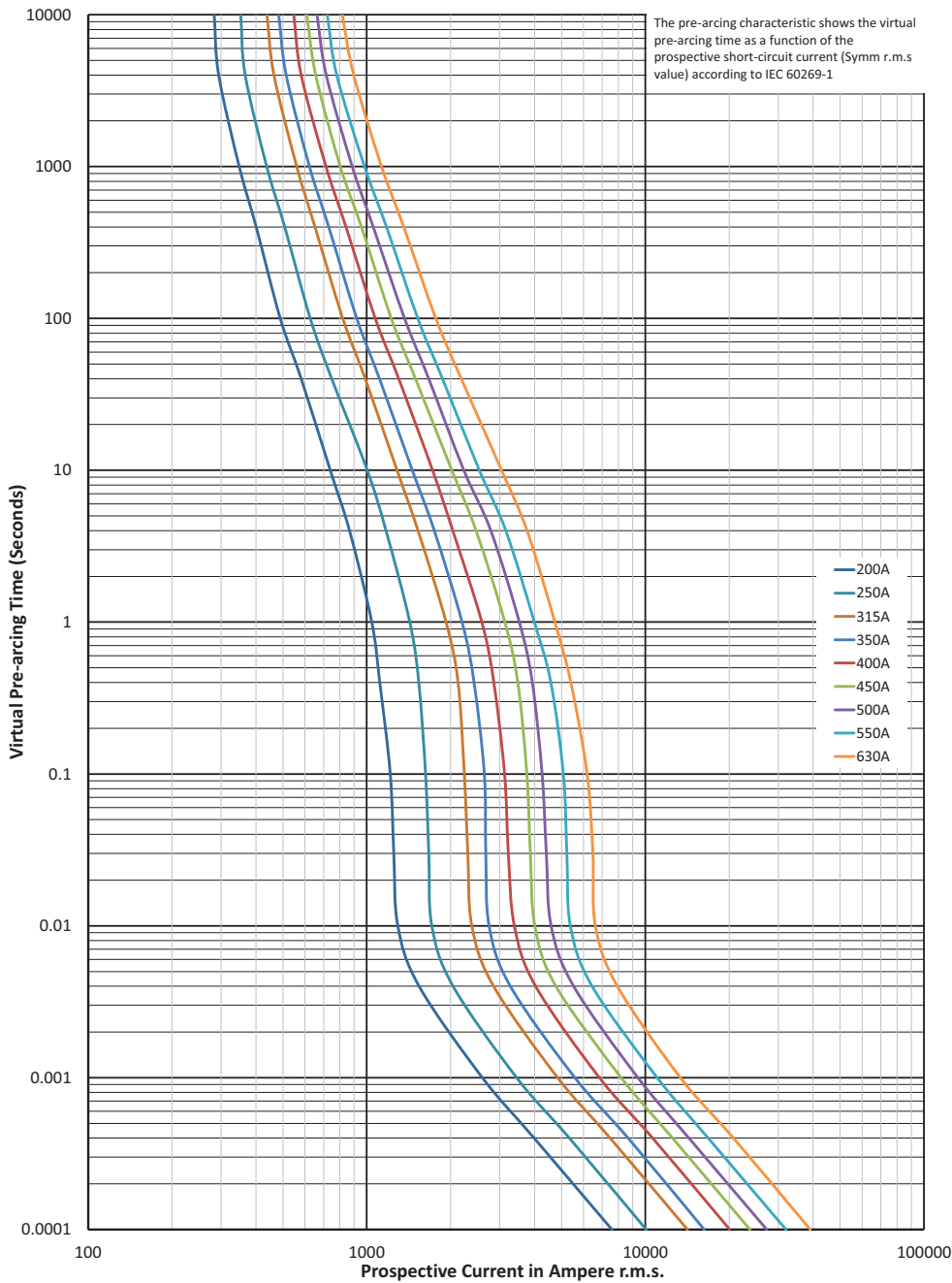

$K_b = 1$     $N = 1.6$

# Square body fuse links

## 170M - Sizes 00 to 3, DIN 43620, Full range (gR), 690 V a.c. (IEC), 10 A to 800 A

### Cut-off curve - Size 2, 200 A to 630 A

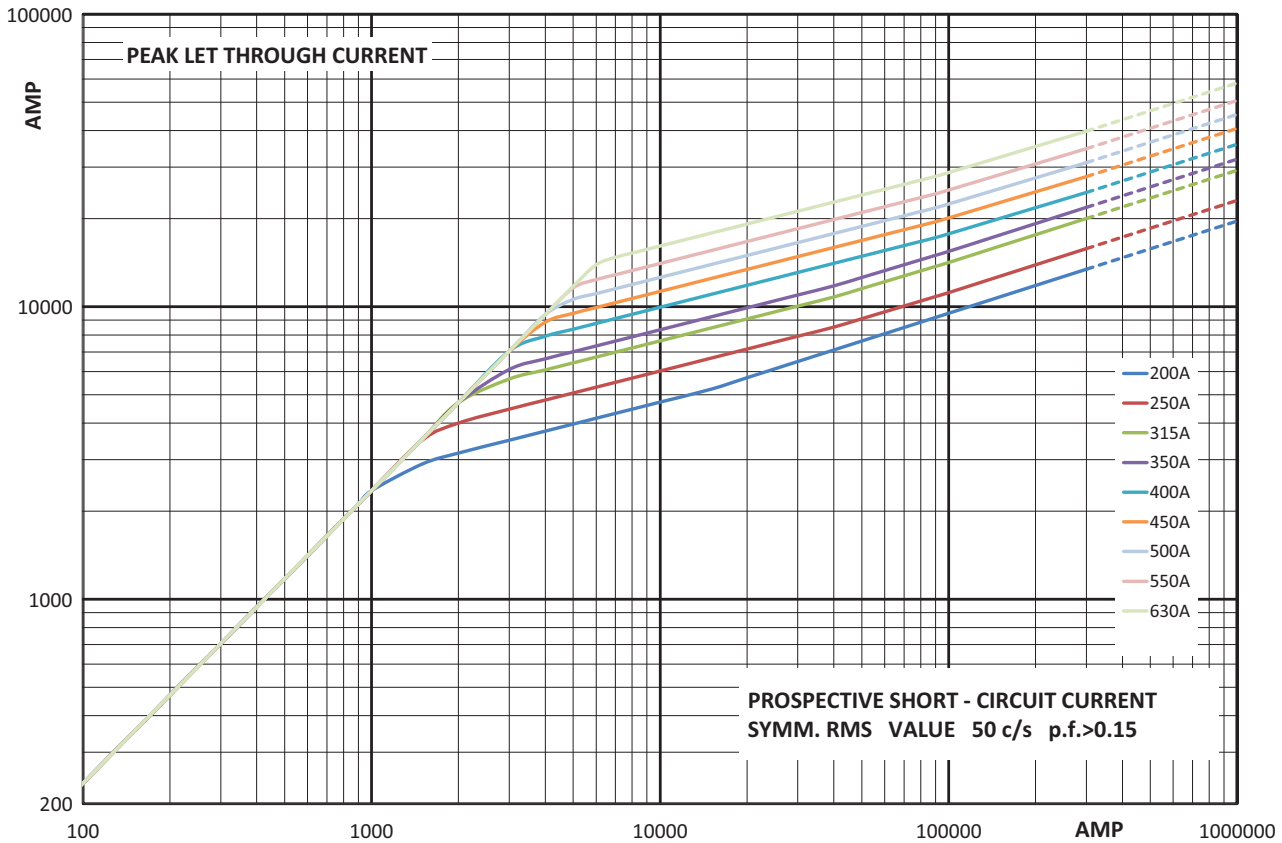

### Total clearing $I^2t$

The total clearing  $I^2t$  at rated voltage and at a power factor of 15 percent are given in the electrical characteristics. For other voltages, the clearing  $I^2t$  is found by multiplying by correction factor,  $K$ , given as a function of applied working voltage,  $E_g$ , (RMS).

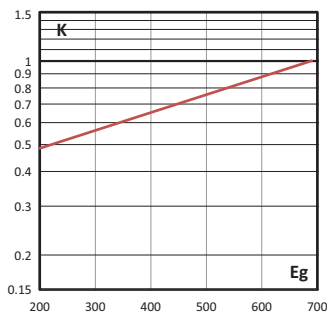

### Arc voltage

This curve gives the peak arc voltage,  $U_L$ , which may appear across the fuse during its operation as a function of the applied working voltage,  $E_g$ , (RMS) at a power factor of 15 percent.

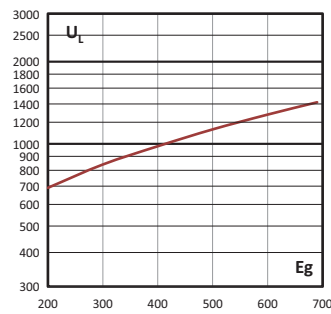

### Watts losses

Watts loss at rated current is given in the electrical characteristics. The curve allows the calculation of the watts losses at load currents lower than the rated current. The correction factor,  $K_p$ , is given as a function of the RMS load current,  $I_b$ , in percent of the rated current.

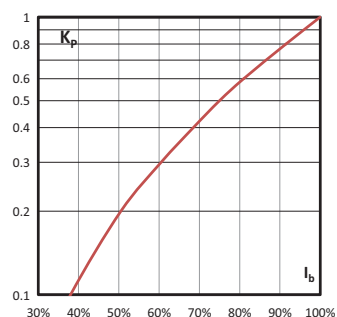

**170M** - Sizes 00 to 3, DIN 43620, Full range (gR), 690 V a.c. (IEC), 10 A to 800 A

Time-current curve - Size 3, 350 A to 800 A

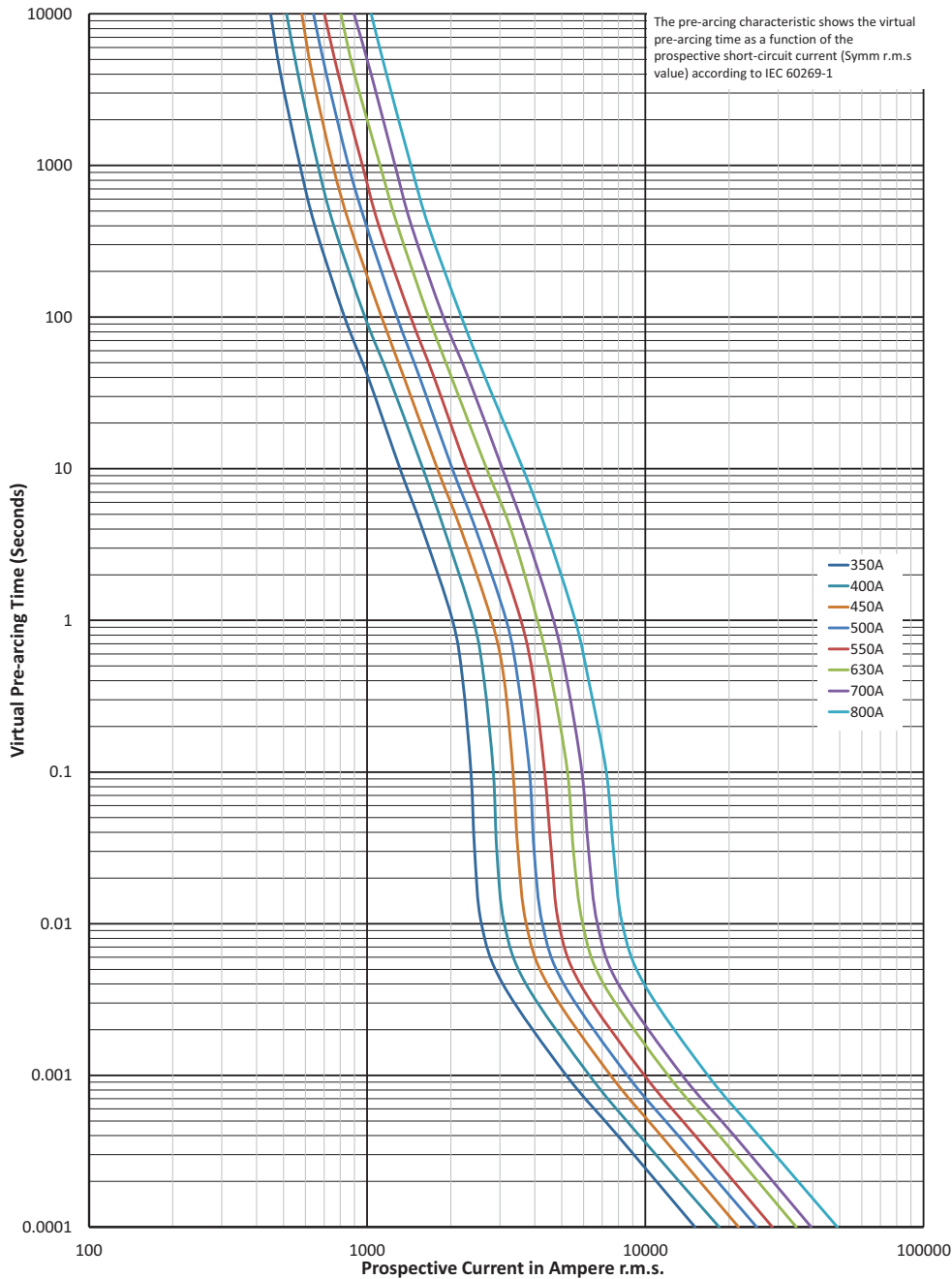

# Square body fuse links

## 170M - Sizes 00 to 3, DIN 43620, Full range (gR), 690 V a.c. (IEC), 10 A to 800 A

### Cut-off curve - Size 3, 350 A to 1000 A

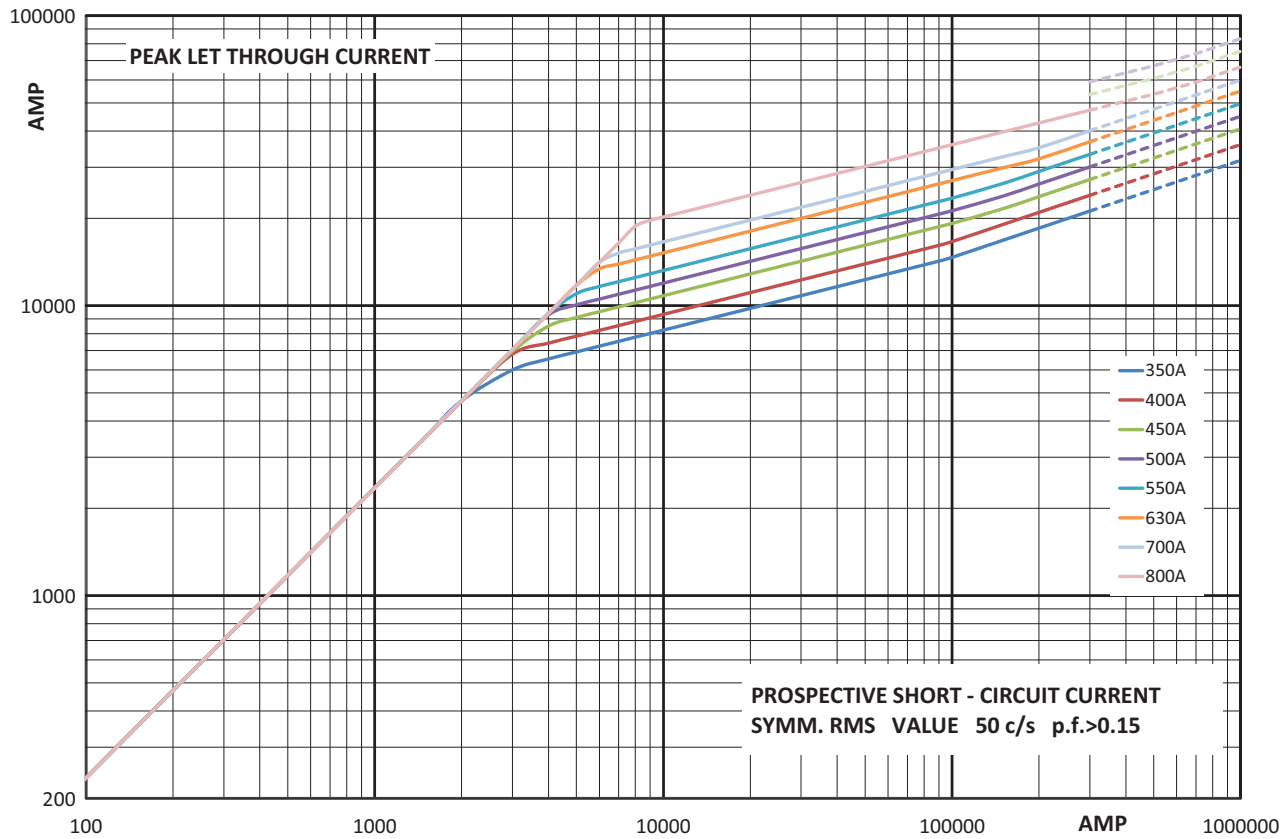

### Total clearing $I^2t$

The total clearing  $I^2t$  at rated voltage and at a power factor of 15 percent are given in the electrical characteristics. For other voltages, the clearing  $I^2t$  is found by multiplying by correction factor,  $K$ , given as a function of applied working voltage,  $E_g$ , (RMS).

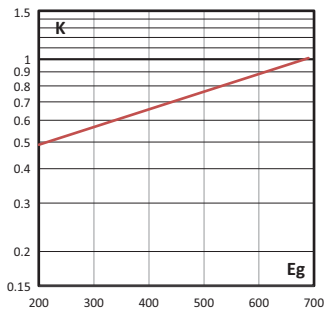

### Arc voltage

This curve gives the peak arc voltage,  $U_L$ , which may appear across the fuse during its operation as a function of the applied working voltage,  $E_g$ , (RMS) at a power factor of 15 percent.

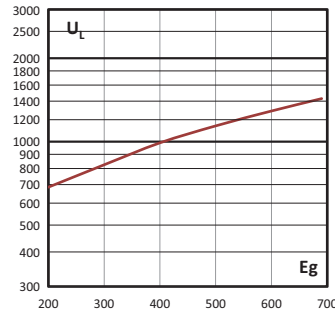

### Watts losses

Watts loss at rated current is given in the electrical characteristics. The curve allows the calculation of the watts losses at load currents lower than the rated current. The correction factor,  $K_p$ , is given as a function of the RMS load current,  $I_b$ , in percent of the rated current.

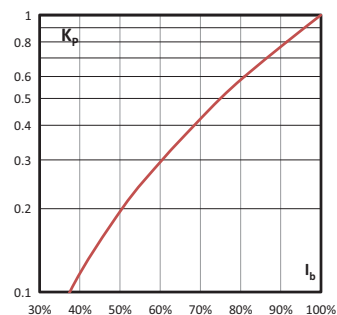

## 170M - Sizes 000 to 3, DIN 43620, Dual indicator fuse links, 690 V a.c. (IEC), 700 V a.c. (UL), 10 A to 1600 A

### Specifications

#### Description

Square body DIN 43620 blade high speed fuse links with dual indicator system: one indicator in the fuse body and another one in the metallic end plate. Interchangeable with existing high speed DIN 43620 fuse links for the protection of UPS, soft starters, solid state relays, variable speed drives, rectifiers and inverters.

#### Technical data

- Rated voltage:
  - 690 V a.c. (IEC)
  - 700 V a.c. (UL)
- Rated current: 10 A to 1600 A
- Breaking capacity: 200 kA RMS Sym
- Operating class: gR (size 000, 10 A to 63A), aR (others)



#### Standards / Agency information

CE, IEC60269 Part 4, UL and CSA Recognised

#### Dimensions (mm)

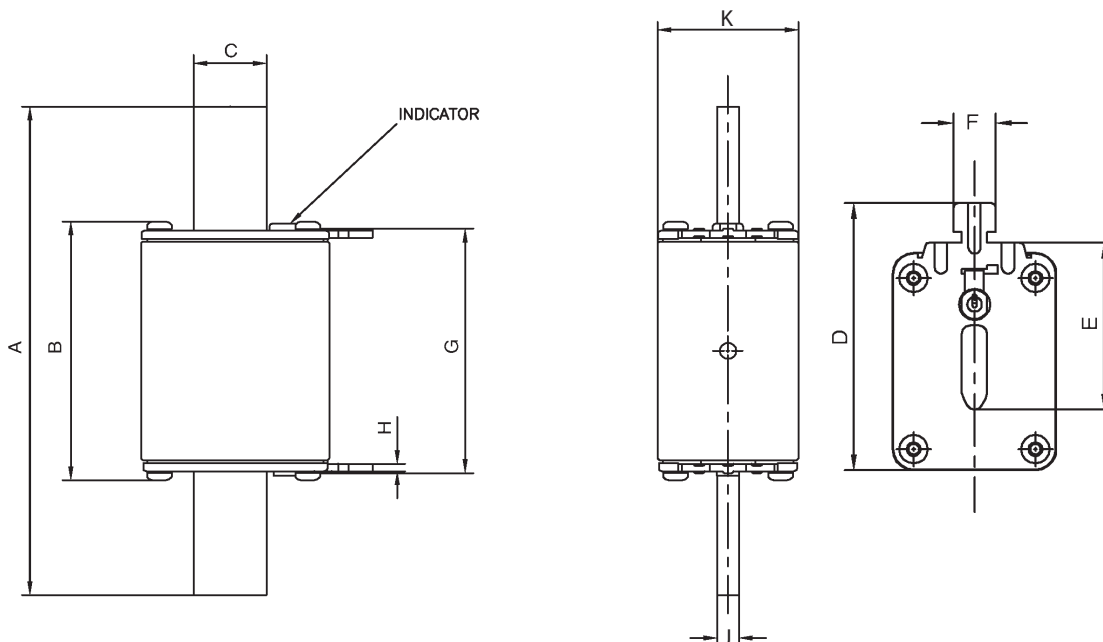

Size	A	B	C	D	E	F	G	H	J	K
000	78.5	53	15	52	35	10	49.7	1.5	6	20.5
00	78.5	53	15	59	35	10	49.7	2	6	30
1	135	71.4	20	64	40	10	67.5	2	6	40
2	150	71.4	25.1	72	48	10	67.5	2	6	54
3	150	72.4	32	87	60	10	68.5	2.5	6	71

Data sheets: 170K6386 (Size 000 and 00), 170K6388 (Size 1), 170K6390 (Size 2), 170K6392 (Size 3)

# Square body fuse links

## 170M - Sizes 000 to 3, DIN 43620, Dual indicator fuse links, 690 V a.c. (IEC), 700 V a.c. (UL), 10 A to 1600 A

### Catalogue numbers

Fuse link body size	Rated voltage	Rated current (Amps)	Max permissible load current	I <sup>2</sup> t (A <sup>2</sup> Sec)		Watts loss (W) <sup>2</sup>	Catalogue numbers
				Pre-arcing	Clearing at 690 V a.c.		Dual indicator
000	690 V a.c. (IEC) 700 V a.c. (UL)	10	10	4	27	2.5	170M1558D
		16	16	7	51	4	170M1559D
		20	20	11.5	82.5	5	170M1560D
		25	25	19	140	6	170M1561D
		32	32	40	285	7	170M1562D
		40	40	65	490	8.5	170M1563D
		50	50	115	815	9.5	170M1564D
		63	63	215	1550	11.5	170M1565D
		80	80	380	2700	15	170M1566D
		100	100	695	4950	16.5	170M1567D
		125	125	1180	8250	21.5	170M1568D
		160	160	2300	16,500	25	170M1569D
		200	200	4350	31,000	29.5	170M1570D
		250	250	7900	56,000	35.5	170M1571D
00	690 V a.c. (IEC) / 700 V a.c. (UL)	315	315	12,000	84,500	45	170M1572D
1	690 V a.c. (IEC) 700 V a.c. (UL)	40	25	40	285	4	170M3808D
		50	30	78	550	4.5	170M3809D
		63	38	120	850	6.5	170M3810D
		80	50	185	1350	8.5	170M3811D
		100	60	360	2600	10	170M3812D
		125	75	550	3900	11	170M3813D
		160	95	1150	8250	12	170M3814D
		200	120	2300	16,500	12.5	170M3815D
		250	150	4350	31,000	16	170M3816D
		315	190	7300	52,000	20	170M3817D
		350	210	10,000	73,000	21.5	170M3818D
		400	240	16,000	115,000	23	170M3819D
		450	270	21,500	155,000	26.5	170M4863D
		500	300	27,000	190,000	28.5	170M4864D
		550	330	33,500	240,000	33	170M4865D
		630	380	48,500	345,000	37.5	170M4866D
700	420	69,500	495,000	39	170M4867D <sup>1</sup>		
2	690 V a.c. (IEC) 700 V a.c. (UL)	400	240	11,000	79,000	29	170M5808D
		450	270	16,000	115,000	32	170M5809D
		500	300	21,500	155,000	34	170M5810D
		550	330	29,000	215,000	36	170M5811D
		630	380	41,000	295,000	42	170M5812D
		700	420	60,500	430,000	43	170M5813D
		800	480	86,000	610,000	48	170M5814D
		900	540	125,000	895,000	52	170M5820D
		1000	600	180,000	1,300,000	53	170M5816D
		1100	660	245,000	1,750,000	56	170M5817D
3	690 V a.c. (IEC) 700 V a.c. (UL)	500	300	14,000	99,500	43	170M6808D
		550	330	19,500	140,000	44	170M6809D
		630	380	31,000	220,000	45	170M6810D
		700	420	45,000	320,000	46	170M6811D
		800	480	69,500	490,000	48	170M6812D
		900	540	100,000	720,000	50	170M6813D
		1000	600	140,000	985,000	56	170M6814D
		1100	660	190,000	1,400,000	57	170M6892D
		1250	750	300,000	2,150,000	61	170M8554D
		1400	840	380,000	2,700,000	70	170M8555D
		1500	900	470,000	3,350,000	72	170M8556D
1600	960	585,000	4,150,000	74	170M8557D		

<sup>1</sup> 170M4867D is not UL recognised.

<sup>2</sup> Given at maximum load Rated current, please refer to data sheets for further details.

Data sheets: 170K6386 (Size 000 and 00), 170K6388 (Size 1), 170K6390 (Size 2), 170K6392 (Size 3)

## 170M - Sizes 000 to 3, DIN 43620, Dual indicator fuse links, 690 V a.c. (IEC), 700 V a.c. (UL), 10 A to 1600 A

### Time-current curve - Sizes 000 and 00, 10 A to 315 A

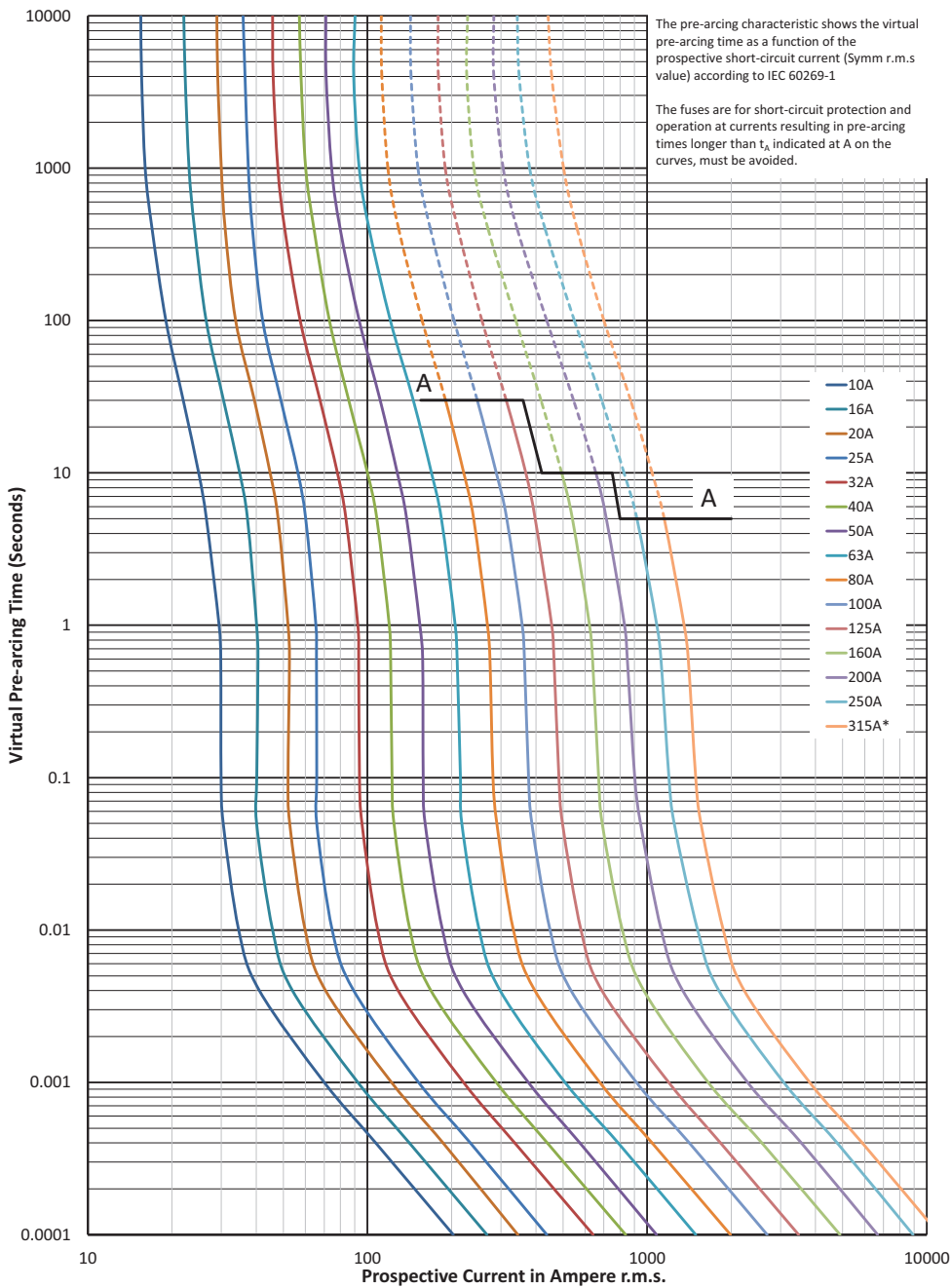

$K_b = 1$     $N = 1.6$

# Square body fuse links

**170M** - Sizes 000 to 3, DIN 43620, Dual indicator fuse links, 690 V a.c. (IEC), 700 V a.c. (UL), 10 A to 1600 A

Cut-off curve - Sizes 000 and 00, 10 A to 315 A

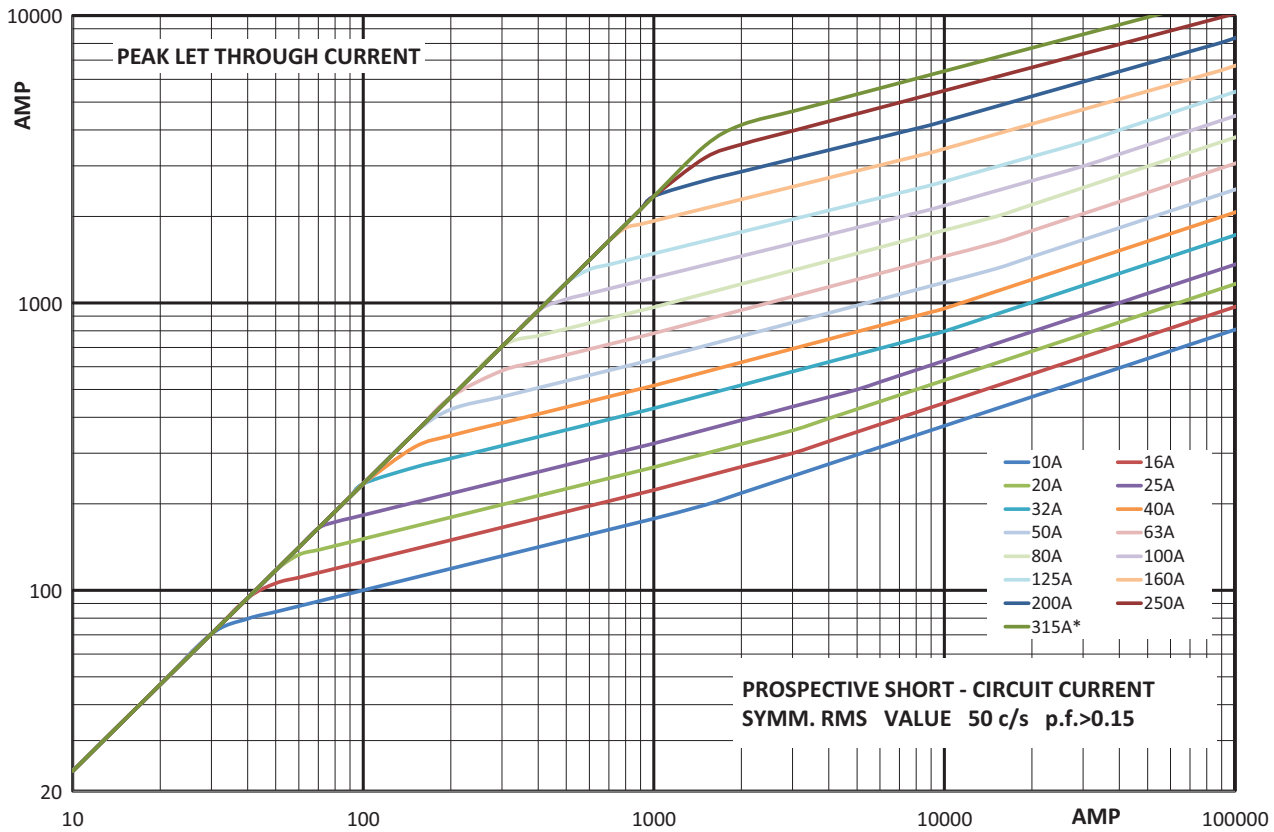

## Total clearing $I^2t$

The total clearing  $I^2t$  at rated voltage and at a power factor of 15 percent are given in the electrical characteristics. For other voltages, the clearing  $I^2t$  is found by multiplying by correction factor,  $K$ , given as a function of applied working voltage,  $E_g$ , (RMS).

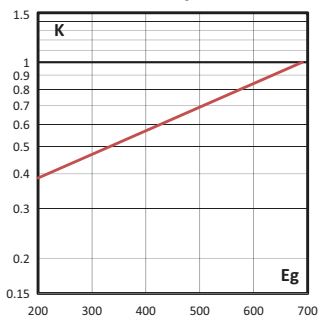

## Arc voltage

This curve gives the peak arc voltage,  $U_L$ , which may appear across the fuse during its operation as a function of the applied working voltage,  $E_g$ , (RMS) at a power factor of 15 percent.

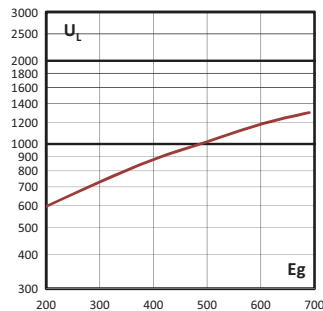

## Watts losses

Watts loss at rated current is given in the electrical characteristics. The curve allows the calculation of the watts losses at load currents lower than the rated current. The correction factor,  $K_p$ , is given as a function of the RMS load current,  $I_b$ , in percent of the rated current.

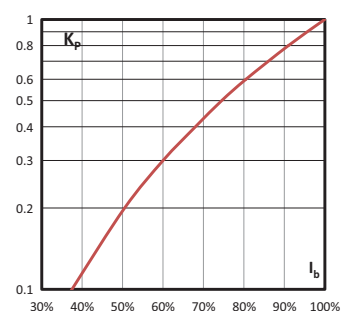

Data sheets: 170K6386 (Size 000 and 00), 170K6388 (Size 1), 170K6390 (Size 2), 170K6392 (Size 3)



## 170M - Sizes 000 to 3, DIN 43620, Dual indicator fuse links, 690 V a.c. (IEC), 700 V a.c. (UL), 10 A to 1600 A

### Time-current curve - Size 1, 40 A to 700 A

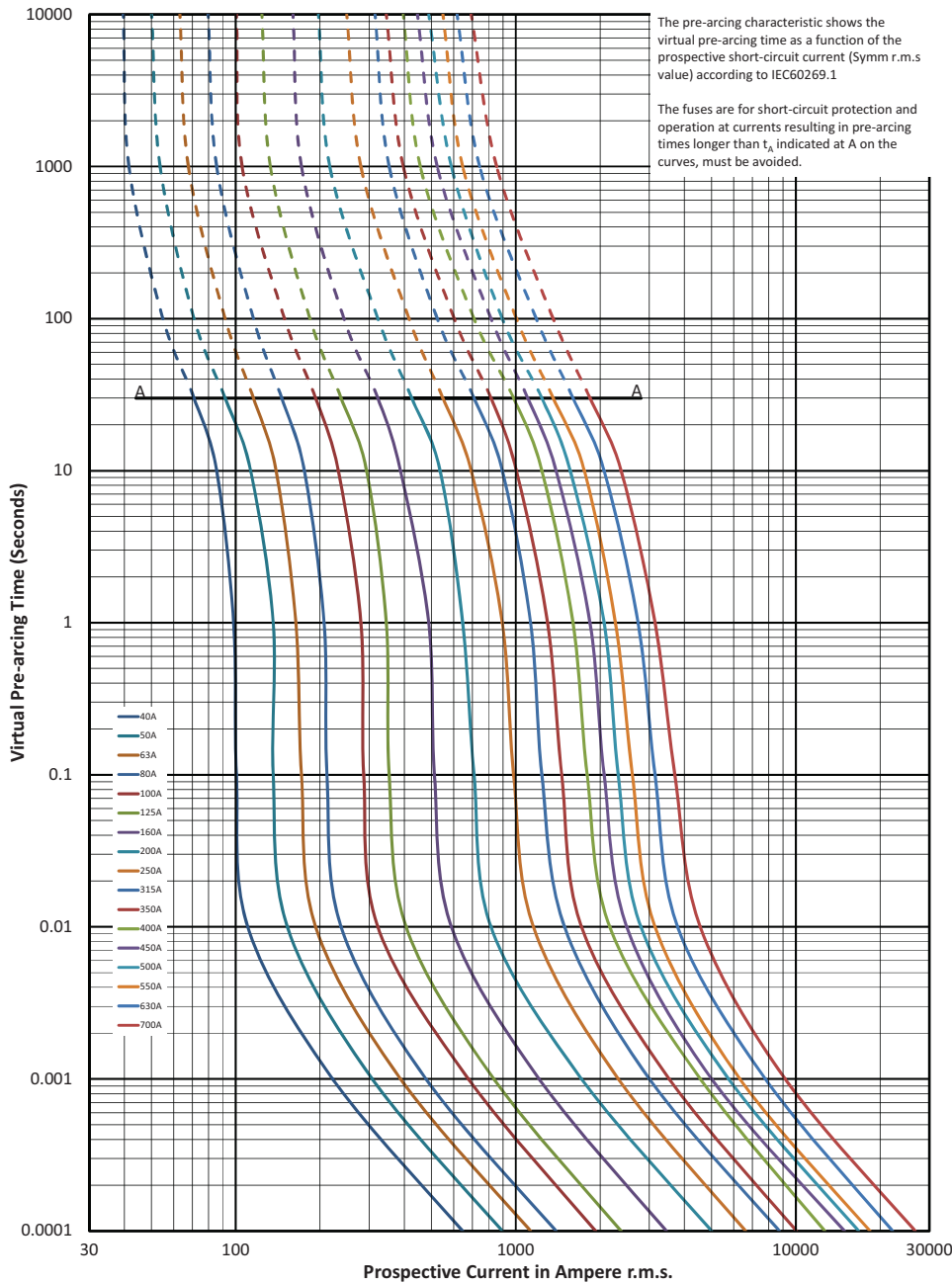

$K_b = 0,6$   $N = 1,6$

# Square body fuse links

**170M** - Sizes 000 to 3, DIN 43620, Dual indicator fuse links, 690 V a.c. (IEC), 700 V a.c. (UL), 10 A to 1600 A

Cut-off curve - Size 1, 40 A to 700 A

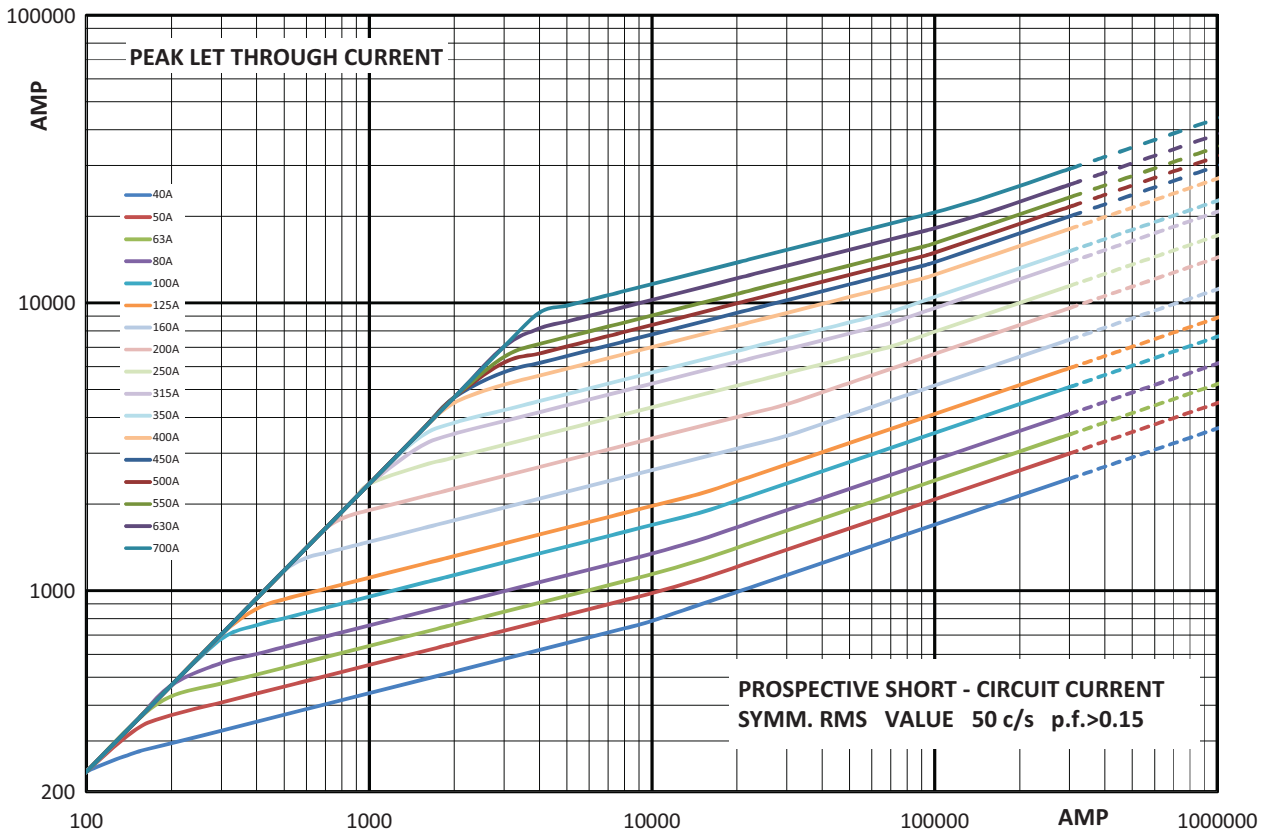

## Total clearing $I^2t$

The total clearing  $I^2t$  at rated voltage and at a power factor of 15 percent are given in the electrical characteristics. For other voltages, the clearing  $I^2t$  is found by multiplying by correction factor,  $K$ , given as a function of applied working voltage,  $E_g$ , (RMS).

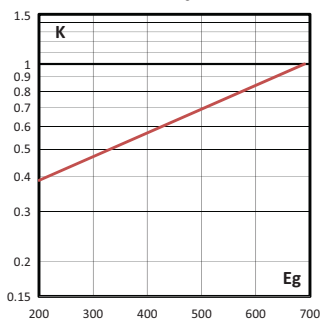

## Arc voltage

This curve gives the peak arc voltage,  $U_L$ , which may appear across the fuse during its operation as a function of the applied working voltage,  $E_g$ , (RMS) at a power factor of 15 percent.

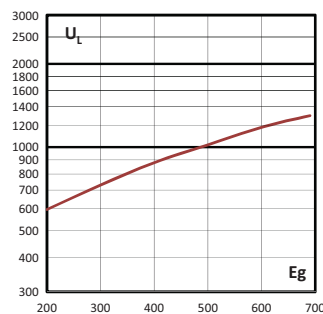

## Watts losses

Watts loss at rated current is given in the electrical characteristics. The curve allows the calculation of the watts losses at load currents lower than the rated current. The correction factor,  $K_p$ , is given as a function of the RMS load current,  $I_b$ , in percent of the rated current.

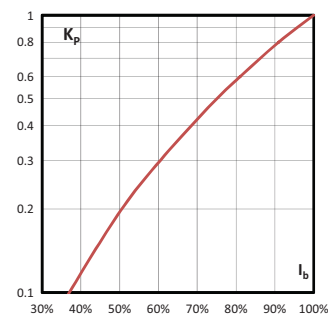

## 170M - Sizes 000 to 3, DIN 43620, Dual indicator fuse links, 690 V a.c. (IEC), 700 V a.c. (UL), 10 A to 1600 A

### Time-current curve - Size 2, 400 A to 1100 A

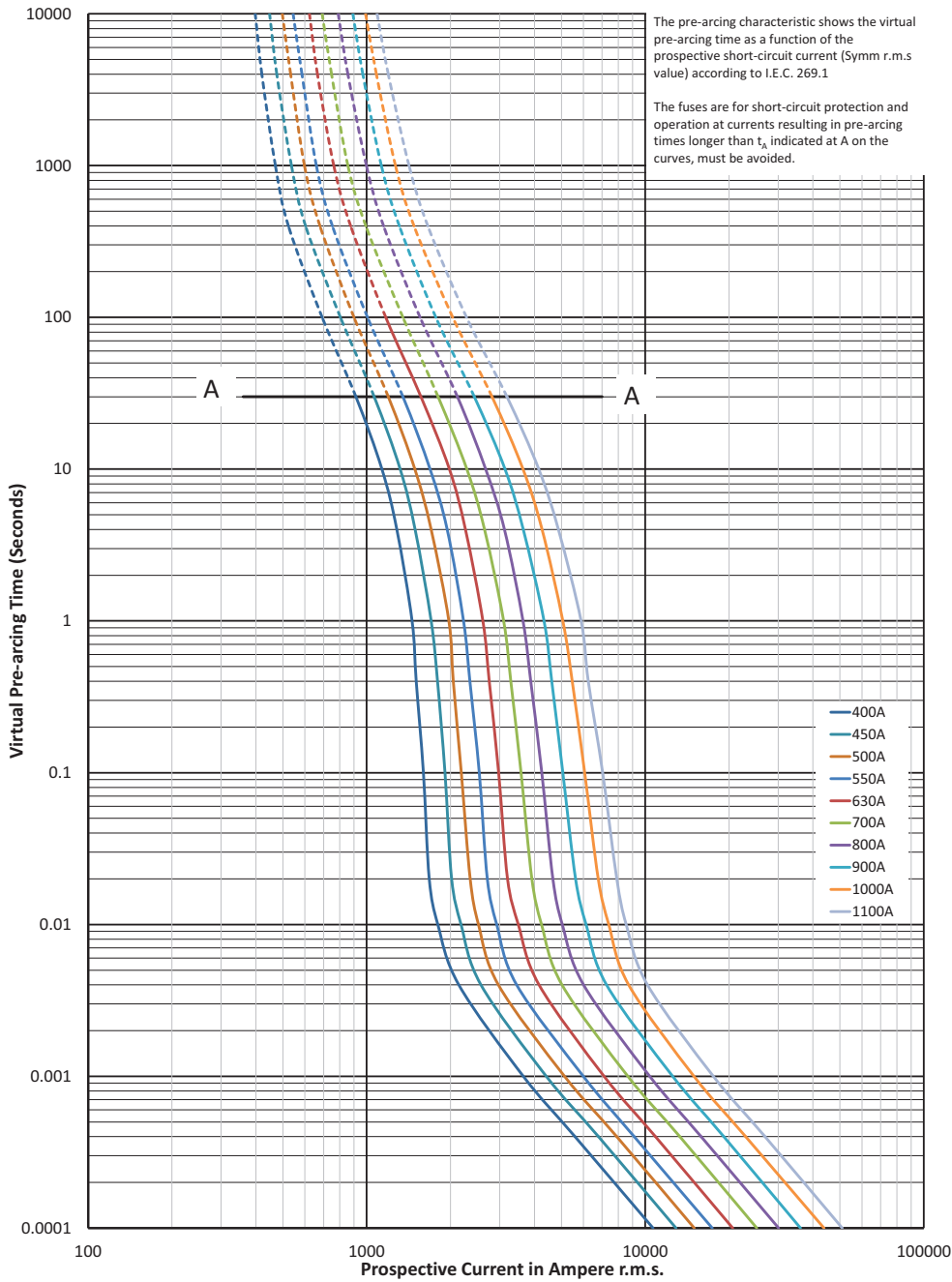

# Square body fuse links

**170M** - Sizes 000 to 3, DIN 43620, Dual indicator fuse links, 690 V a.c. (IEC), 700 V a.c. (UL), 10 A to 1600 A

Cut-off curve - Size 2, 400 A to 1100 A

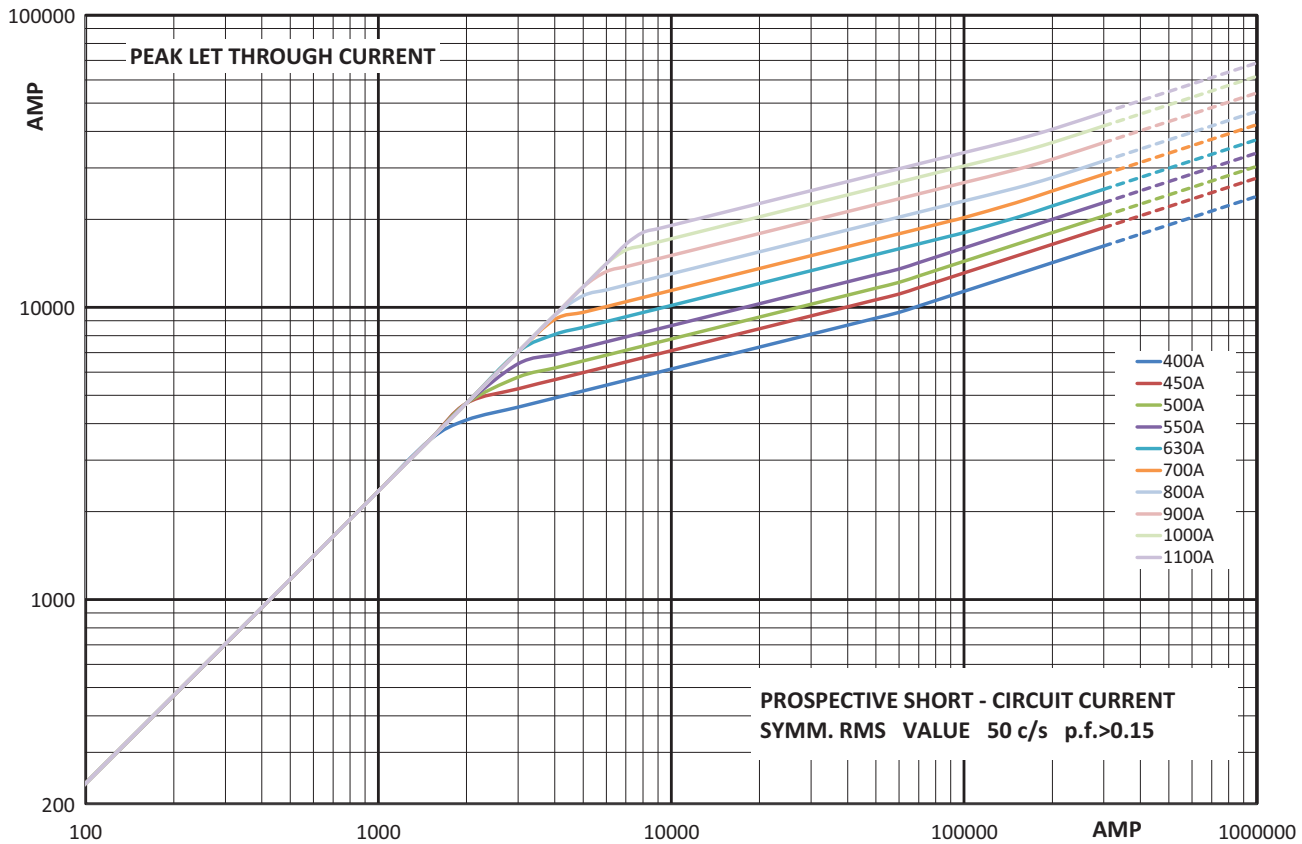

## Total clearing $I^2t$

The total clearing  $I^2t$  at rated voltage and at a power factor of 15 percent are given in the electrical characteristics. For other voltages, the clearing  $I^2t$  is found by multiplying by correction factor,  $K$ , given as a function of applied working voltage,  $E_g$ , (RMS).

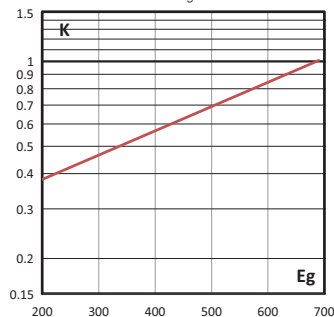

## Arc voltage

This curve gives the peak arc voltage,  $U_L$ , which may appear across the fuse during its operation as a function of the applied working voltage,  $E_g$ , (RMS) at a power factor of 15 percent.

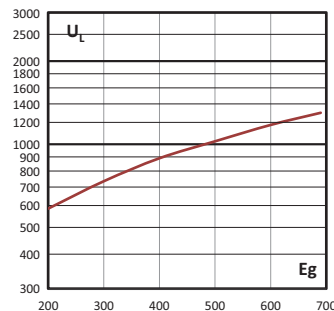

## Watts losses

Watts loss at rated current is given in the electrical characteristics. The curve allows the calculation of the watts losses at load currents lower than the rated current. The correction factor,  $K_p$ , is given as a function of the RMS load current,  $I_b$ , in percent of the rated current.

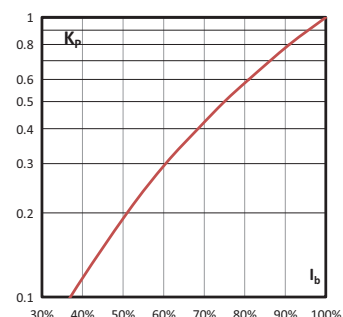

Data sheets: 170K6386 (Size 000 and 00), 170K6388 (Size 1), 170K6390 (Size 2), 170K6392 (Size 3)

## 170M - Sizes 000 to 3, DIN 43620, Dual indicator fuse links, 690 V a.c. (IEC), 700 V a.c. (UL), 10 A to 1600 A

### Time-current curve - Size 3, 500 A to 1600 A

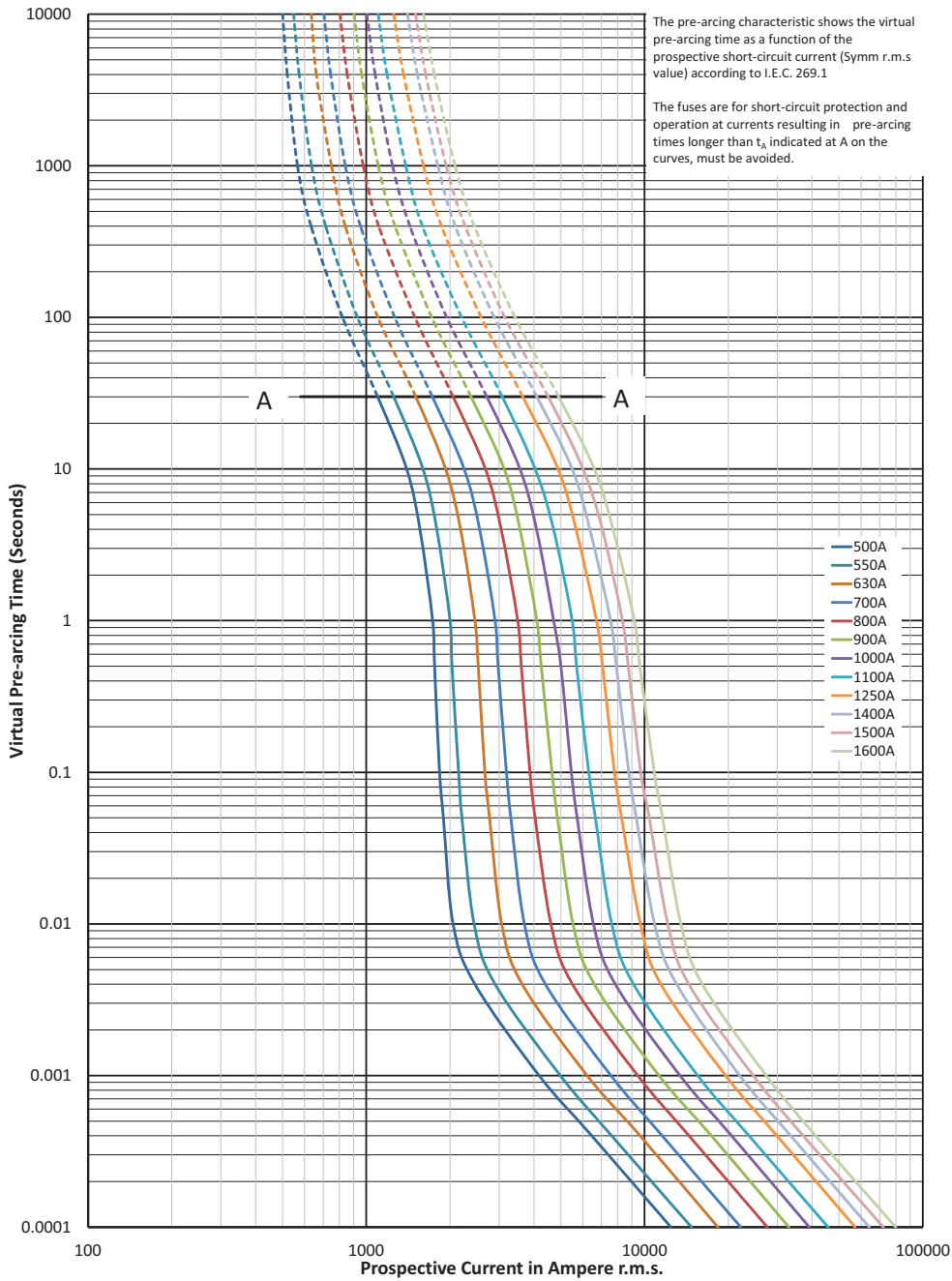

# Square body fuse links

**170M** - Sizes 000 to 3, DIN 43620, Dual indicator fuse links, 690 V a.c. (IEC), 700 V a.c. (UL), 10 A to 1600 A

Cut-off curve - Size 3, 500 A to 1600 A

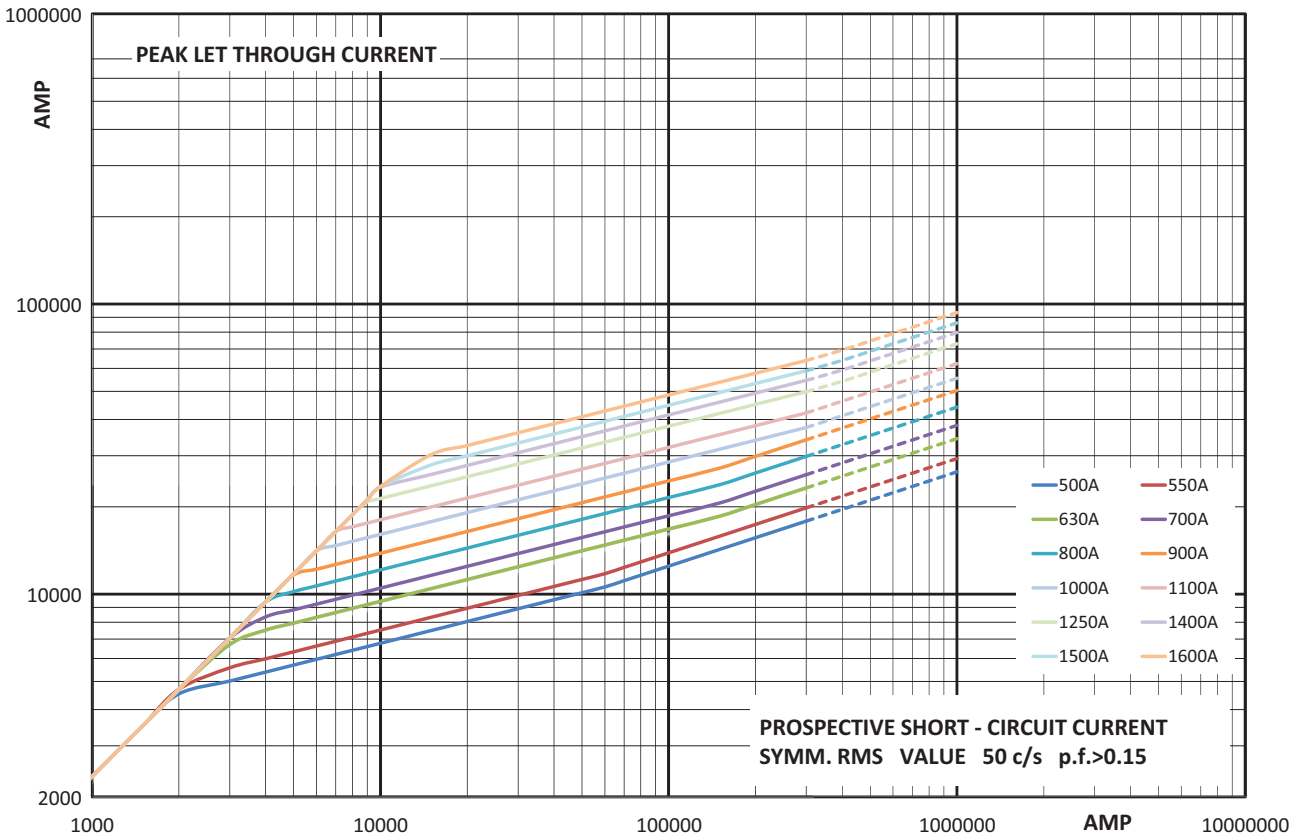

## Total clearing $I^2t$

The total clearing  $I^2t$  at rated voltage and at a power factor of 15 percent are given in the electrical characteristics. For other voltages, the clearing  $I^2t$  is found by multiplying by correction factor,  $K$ , given as a function of applied working voltage,  $E_g$ , (RMS).

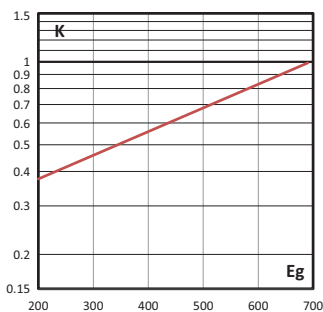

## Arc voltage

This curve gives the peak arc voltage,  $U_L$ , which may appear across the fuse during its operation as a function of the applied working voltage,  $E_g$ , (RMS) at a power factor of 15 percent.

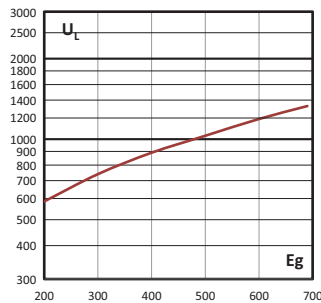

## Watts losses

Watts loss at rated current is given in the electrical characteristics. The curve allows the calculation of the watts losses at load currents lower than the rated current. The correction factor,  $K_p$ , is given as a function of the RMS load current,  $I_b$ , in percent of the rated current.

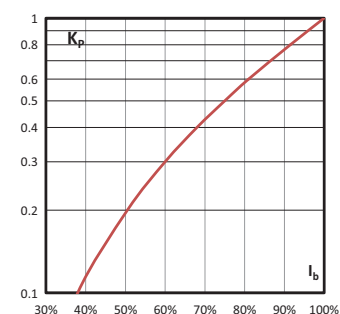

Data sheets: 170K6386 (Size 000 and 00), 170K6388 (Size 1), 170K6390 (Size 2), 170K6392 (Size 3)

## 170M - Size 00, DIN 43620, 1000 V a.c. (IEC and UL), 20 A to 225 A

### Specifications

#### Description

Square body DIN 43620 blade style high speed fuse links for the protection of DC common bus, DC drives, power converters/rectifiers and reduced rated voltage starters.

#### Technical data

- Rated voltage:
  - 1000 V a.c. (IEC and UL)
  - 900 V a.c. (200 A and 225A)
- Rated current: 20 A to 225 A
- Breaking capacity: 125kA RMS Sym
- Operating class: aR

#### Standards / Agency information

CE, Designed and tested to IEC60269 Part 4, UL Recognised/CSA Component Acceptance status (20 A to 160 A)



#### Catalogue numbers

Fuse link body size	Rated voltage	Rated current Amps)	I <sup>2</sup> t (A <sup>2</sup> Sec)		Watts loss (W)	Catalogue numbers	
			Pre-arcing	Clearing at 1000 V a.c.		Type T indicator for micro	
00	1000 V a.c. (IEC/UL)	20	15	110	8.5	170M2673	
		25	28.5	210	9.5	170M2674	
		32	53	390	11	170M2675	
		35	69	500	12	170M2676	
		40	105	760	13	170M2677	
		50	215	1550	14	170M2678	
		63	380	2750	16	170M2679	
		80	815	5900	18	170M2680	
		100	1550	11,500	21	170M2681	
		125	3000	22,000	23	170M2682	
		160	6250	45,000	26	170M2683	
00	900 V a.c. (IEC)	200	12,000	86,500	31	170M2684	
		225	18,000	115,000	33	170M2685	

#### Dimensions (mm)

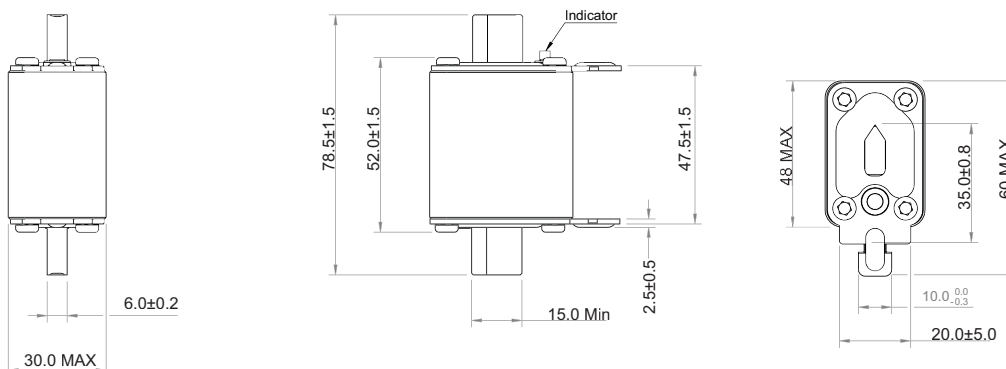

# Square body fuse links

## 170M - Size 00, DIN 43620, 1000 V a.c. (IEC and UL), 20 A to 225 A

### Time-current curve - Size 00, 20 A to 225 A

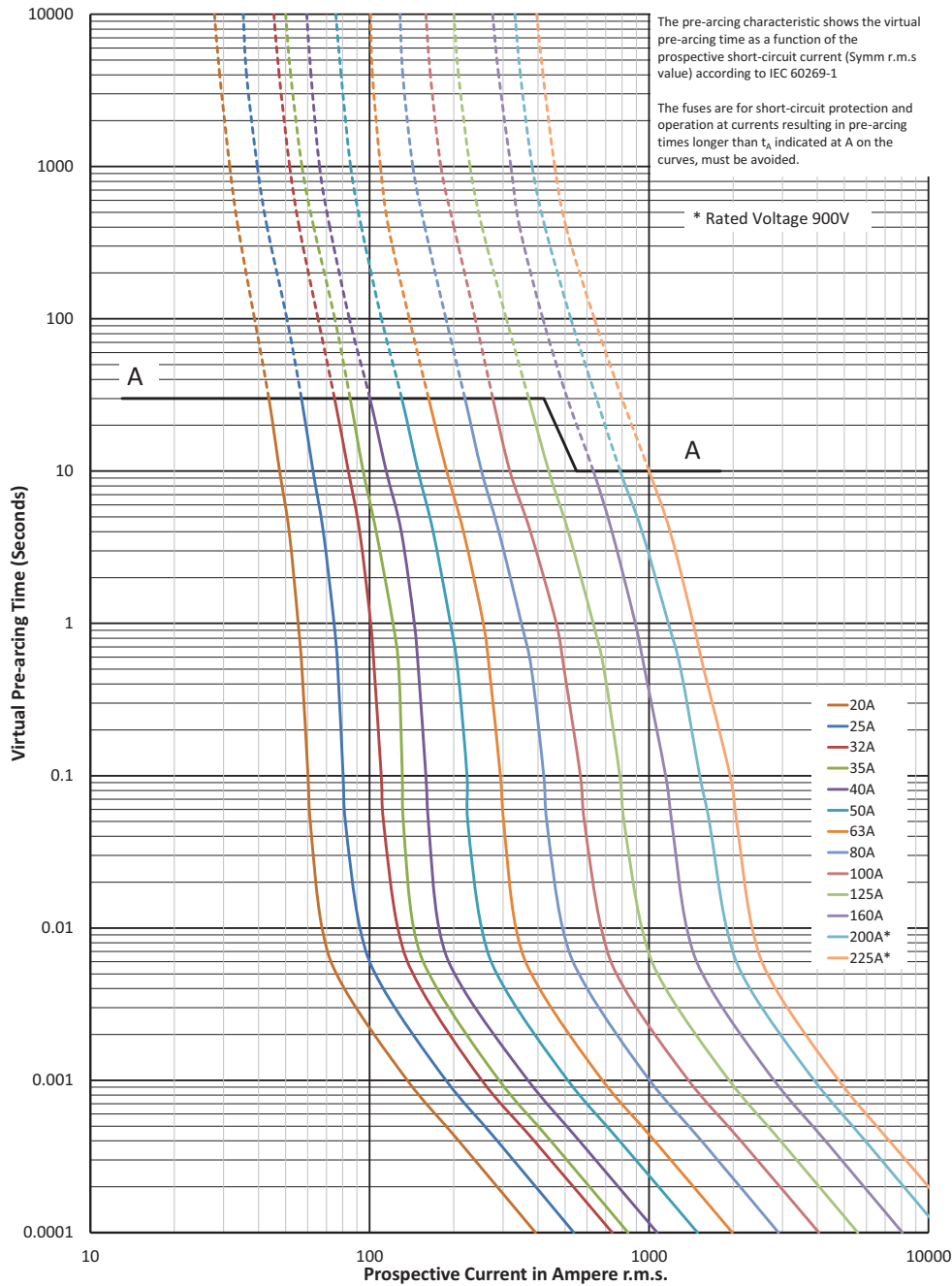

$K_b = 1$   $N = 1.6$



**170M - Size 00, DIN 43620, 1000 V a.c. (IEC and UL), 20 A to 225 A**

Cut-off curve - Size 00, 20 A to 225 A

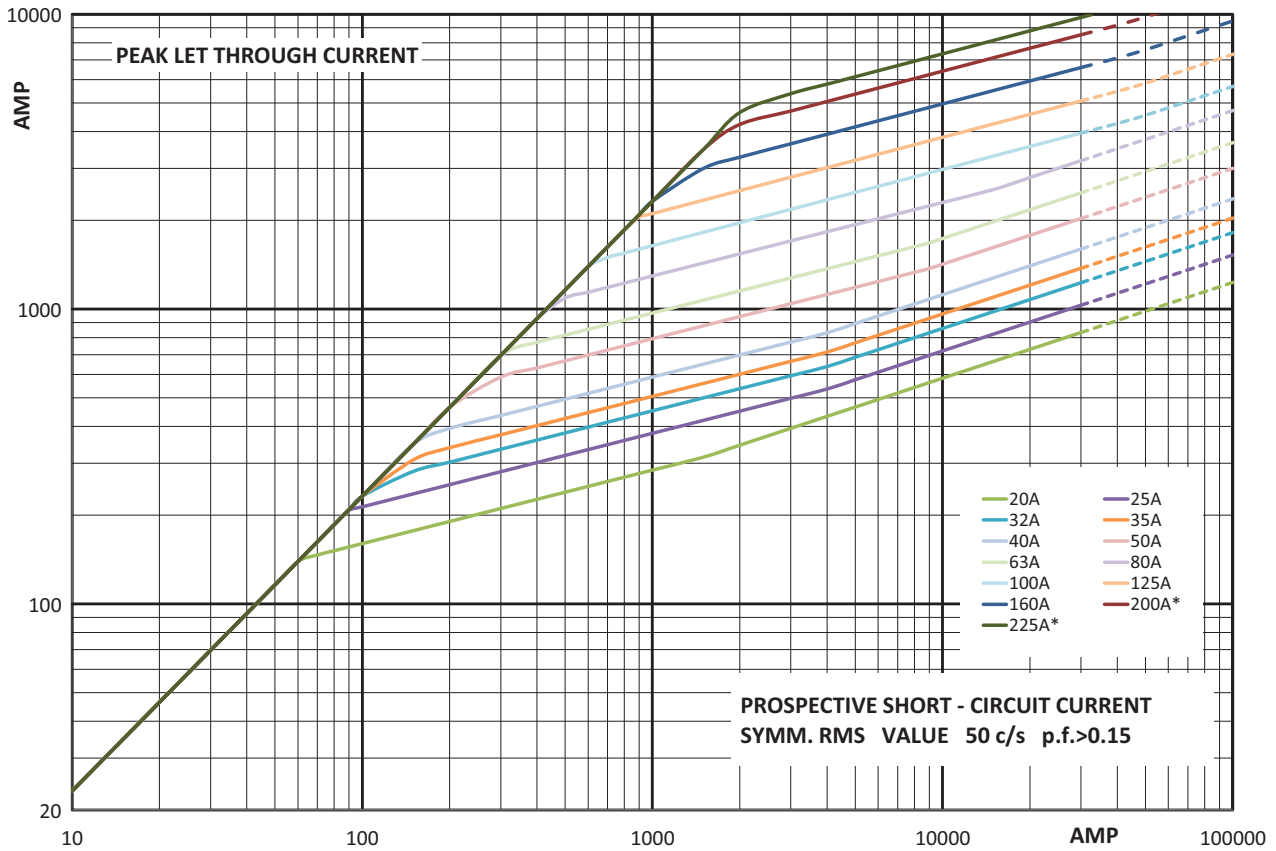

**Total clearing  $I^2t$**

The total clearing  $I^2t$  at rated voltage and at a power factor of 15 percent are given in the electrical characteristics. For other voltages, the clearing  $I^2t$  is found by multiplying by correction factor,  $K$ , given as a function of applied working voltage,  $E_g$ , (RMS).

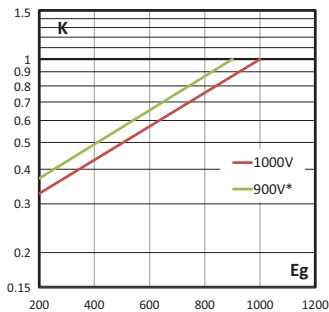

**Arc voltage**

This curve gives the peak arc voltage,  $U_L$ , which may appear across the fuse during its operation as a function of the applied working voltage,  $E_g$ , (RMS) at a power factor of 15 percent.

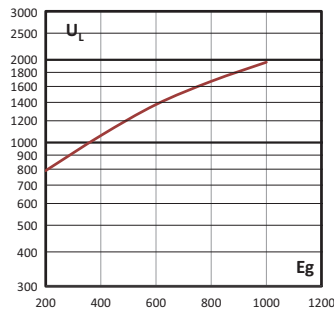

**Watts losses**

Watts loss at rated current is given in the electrical characteristics. The curve allows the calculation of the watts losses at load currents lower than the rated current. The correction factor,  $K_p$ , is given as a function of the RMS load current,  $I_b$ , in percent of the rated current.

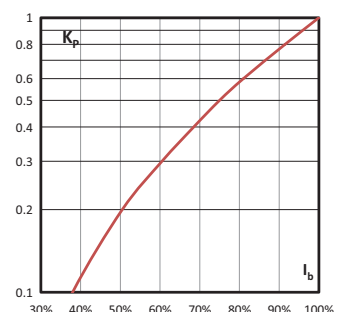

# Square body fuse links

## 170M - Sizes 1\* to 3, French style, 690 V a.c. (IEC), 700 V a.c. (UL), 40 A to 1600 A

### Specifications

#### Description

Square body French style high speed fuse links for the protection of DC common bus, DC drives, power converters/rectifiers and reduced rated voltage starters.

#### Technical data

- Rated voltage:
  - 690 V a.c. (IEC)
  - 700 V a.c. (UL)
- Rated current: 40 A to 1600 A
- Breaking capacity: 200 kA RMS Sym
- Operating class: aR

#### Standards / Agency information

CE, Designed and tested to IEC60269 Part 4, UL Recognised.  
For CCC approval, please consult Eaton [bulehighspeedtechnical@eaton.com](mailto:bulehighspeedtechnical@eaton.com)



#### Dimensions (mm)

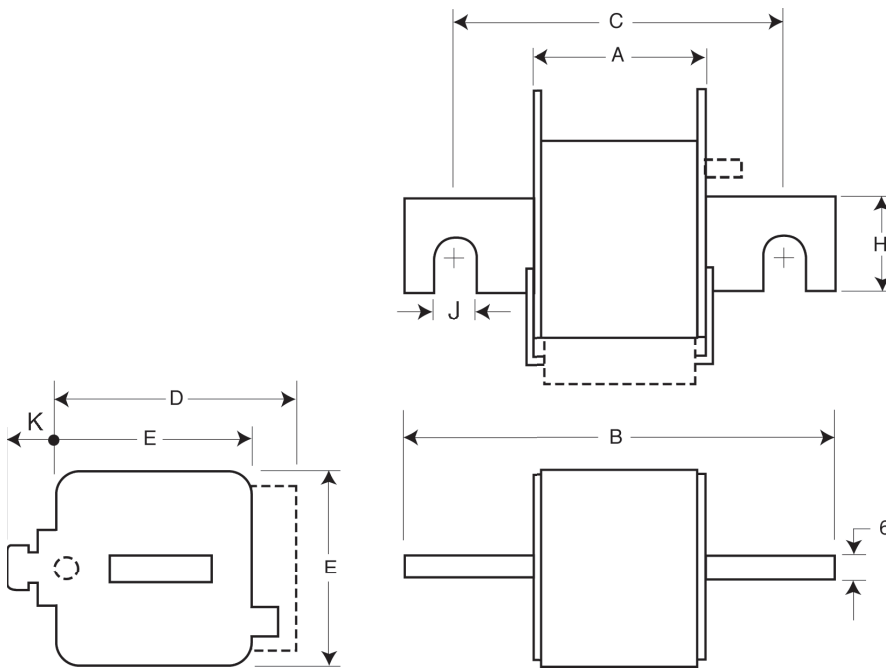

Size	A	B	C	D	E	H	J	K
1*	50	102	76	59	45	18	9	13
1	50	111	86	69	53	25	11	11
2	50	126	91	77	61	30	13	12
3	51	126	91	92	76	36	13	13

Data sheets: 170K6314 (Size 1\*), 170K6316 (Size 1), 170K6318 (Size 2), 170K6320 (Size 3)

**170M - Sizes 1\* to 3, French style, 690 V a.c. (IEC), 700 V a.c. (UL), 40 A to 1600 A**

Catalogue numbers

Fuse link body size	Rated voltage	Rated current (Amps)	I <sup>2</sup> t (A <sup>2</sup> Sec)		Watts loss (W)	Catalogue numbers	
			Pre-arcing	Clearing at 660 V a.c.		-E/- Type T indicator for micro	-EKN/- Type K indicator for micro
1*	690 V a.c. (IEC) 700 V a.c.(UL)	40	40	270	9	170M3308	170M3358
		50	77	515	11	170M3309	170M3359
		63	115	770	14	170M3310	170M3360
		80	185	1250	18	170M3311	170M3361
		100	360	2450	21	170M3312	170M3362
		125	550	3700	26	170M3313	170M3363
		160	1100	7500	30	170M3314	170M3364
		200	2200	15,000	35	170M3315	170M3365
		250	4200	28,500	40	170M3316	170M3366
		315	7000	46,500	50	170M3317	170M3367
		350	10,000	68,500	55	170M3318	170M3368
		400	15,000	105,000	60	170M3319	170M3369
		450	21,000	140,000	65	170M3320	170M3370
		500	27,000	180,000	70	170M3321	170M3371
1	690 V a.c. (IEC) 700 V a.c.(UL)	200	1650	11,500	45	170M4308	170M4358
		250	3100	21,000	55	170M4309	170M4359
		315	6200	42,000	58	170M4310	170M4360
		350	8500	59,000	60	170M4311	170M4361
		400	13,500	91,500	65	170M4312	170M4362
		450	17,000	120,000	70	170M4313	170M4363
		500	25,000	170,000	72	170M4314	170M4364
		550	34,000	230,000	75	170M4315	170M4365
		630	52,000	350,000	80	170M4316	170M4366
		700	69,500	465,000	85	170M4317	170M4367
2	690 V a.c. (IEC) 700 V a.c.(UL)	800	105,000	725,000	95	170M4318	170M4368
		400	11,000	74,000	65	170M5308	170M5358
		450	15,500	105,000	70	170M5309	170M5359
		500	21,500	145,000	75	170M5310	170M5360
		550	28,000	190,000	80	170M5311	170M5361
		630	41,000	275,000	90	170M5312	170M5362
		700	60,500	405,000	95	170M5313	170M5363
		800	86,000	575,000	105	170M5314	170M5364
		900	125,000	840,000	110	170M5315	170M5365
		1000	180,000	1,250,000	115	170M5316	170M5366
3	690 V a.c. (IEC) 700 V a.c.(UL)	500	14,000	95,000	95	170M6308	170M6358
		550	19,500	135,000	100	170M6309	170M6359
		630	31,000	210,000	105	170M6310	170M6360
		700	44,500	300,000	110	170M6311	170M6361
		800	69,500	465,000	115	170M6312	170M6362
		900	100,000	670,000	120	170M6313	170M6363
		1000	140,000	945,000	125	170M6314	170M6364
		1100	190,000	1,300,000	130	170M6315	170M6365
		1250	290,000	1,950,000	140	170M6316	170M6366
		1400	370,000	2,450,000	155	170M6317	170M6367
		1500	460,000	3,100,000	160	170M6318	170M6368
		1600	580,000	3,900,000	160	170M6319	170M6369

Data sheets: 170K6314 (Size 1\*), 170K6316 (Size 1), 170K6318 (Size 2), 170K6320 (Size 3)

# Square body fuse links

## 170M - Sizes 1\* to 3, French style, 690 V a.c. (IEC), 700 V a.c. (UL), 40 A to 1600 A

### Time-current curve - Size 1\*, 40 A to 500 A

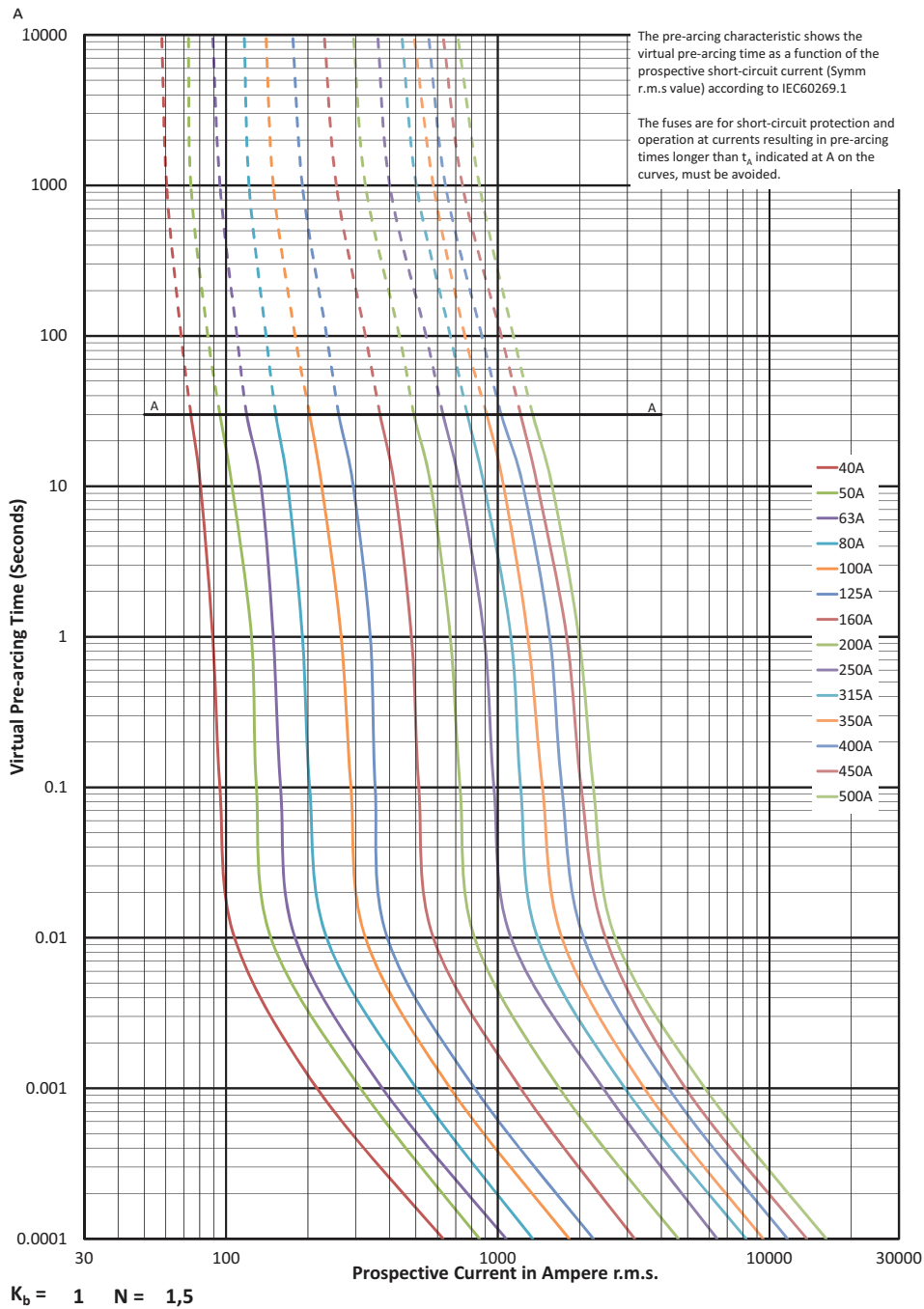

Data sheets: 170K6314 (Size 1\*), 170K6316 (Size 1), 170K6318 (Size 2), 170K6320 (Size 3)

**170M - Sizes 1\* to 3, French style, 690 V a.c. (IEC), 700 V a.c. (UL), 40 A to 1600 A**

**Cut-off curve - Size 1\*, 40 A to 500 A**

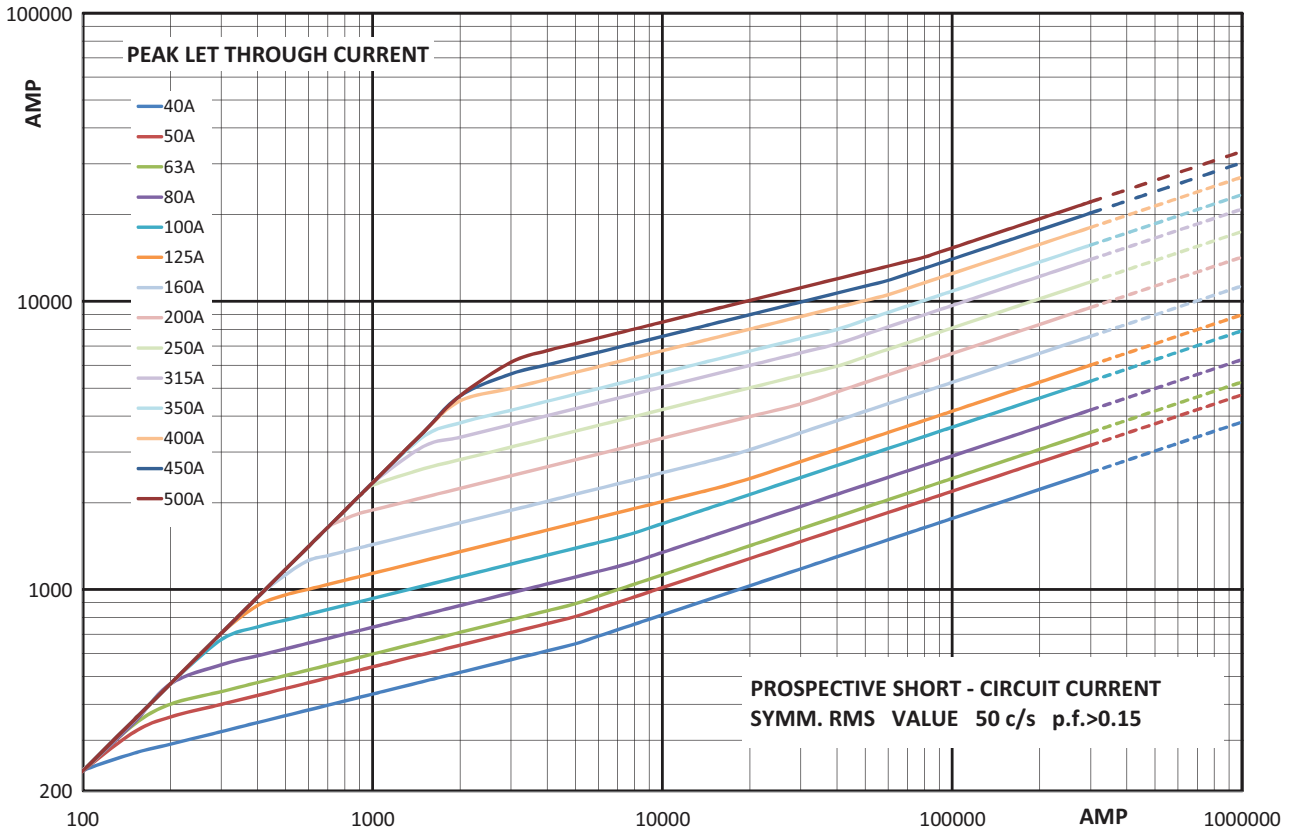

**Total clearing  $I^2t$**

The total clearing  $I^2t$  at rated voltage and at a power factor of 15 percent are given in the electrical characteristics. For other voltages, the clearing  $I^2t$  is found by multiplying by correction factor,  $K$ , given as a function of applied working voltage,  $E_g$ , (RMS).

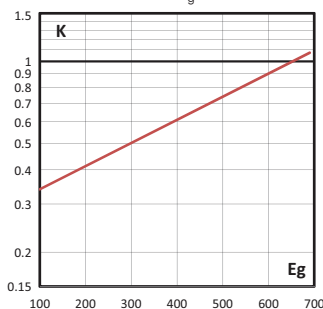

**Arc voltage**

This curve gives the peak arc voltage,  $U_L$ , which may appear across the fuse during its operation as a function of the applied working voltage,  $E_g$ , (RMS) at a power factor of 15 percent.

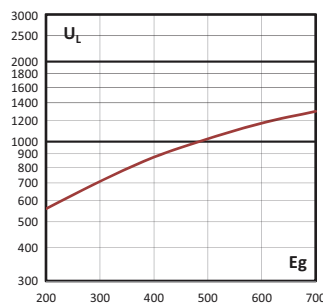

**Watts losses**

Watts loss at rated current is given in the electrical characteristics. The curve allows the calculation of the watts losses at load currents lower than the rated current. The correction factor,  $K_p$ , is given as a function of the RMS load current,  $I_b$ , in percent of the rated current.

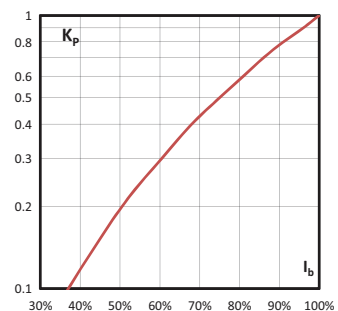

# Square body fuse links

## 170M - Sizes 1\* to 3, French style, 690 V a.c. (IEC), 700 V a.c. (UL), 40 A to 1600 A

### Time-current curve - Size 1, 200 A to 800 A

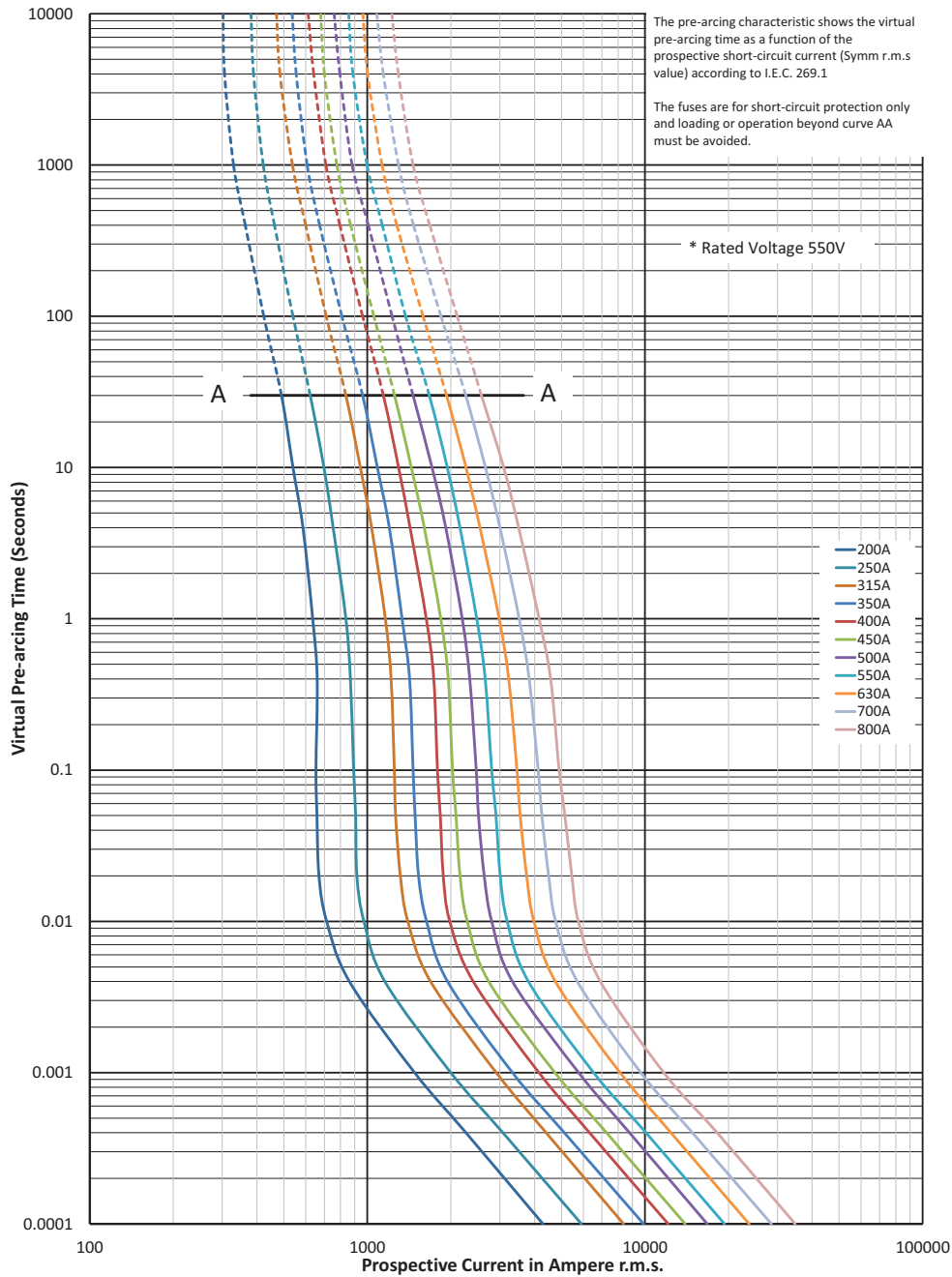

$K_b = 1$   $N = 1.5$

## 170M - Sizes 1\* to 3, French style, 690 V a.c. (IEC), 700 V a.c. (UL), 40 A to 1600 A

### Cut-off curve - Size 1, 200 A to 800 A

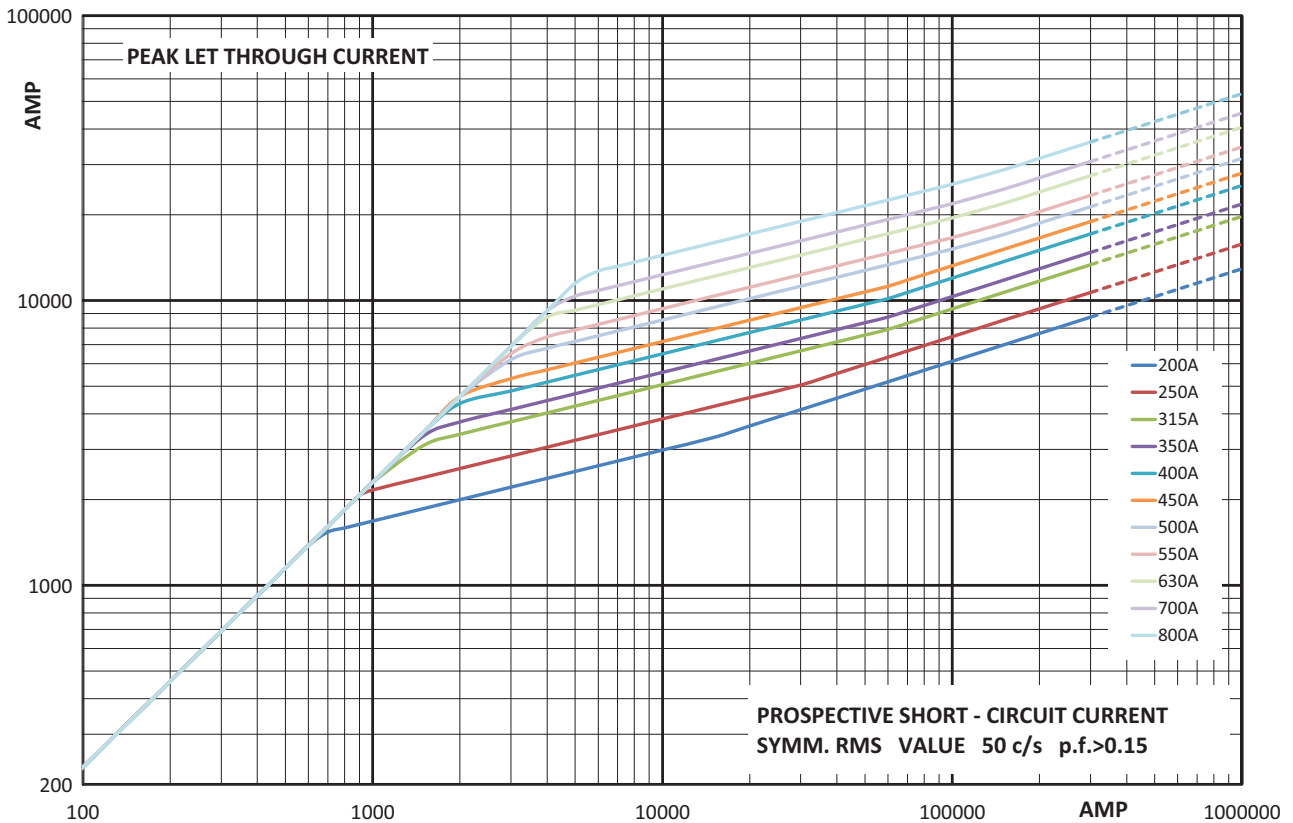

### Total clearing $I^2t$

The total clearing  $I^2t$  at rated voltage and at a power factor of 15 percent are given in the electrical characteristics. For other voltages, the clearing  $I^2t$  is found by multiplying by correction factor,  $K$ , given as a function of applied working voltage,  $E_g$ , (RMS).

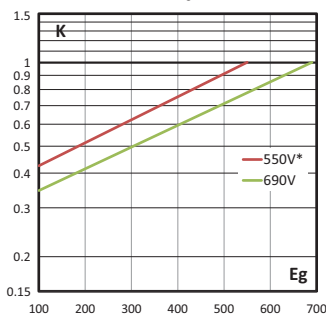

### Arc voltage

This curve gives the peak arc voltage,  $U_L$ , which may appear across the fuse during its operation as a function of the applied working voltage,  $E_g$ , (RMS) at a power factor of 15 percent.

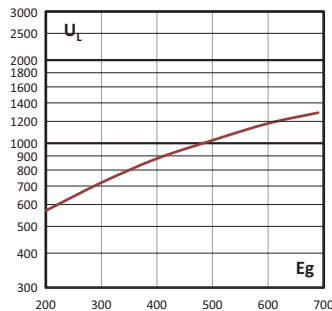

### Watts losses

Watts loss at rated current is given in the electrical characteristics. The curve allows the calculation of the watts losses at load currents lower than the rated current. The correction factor,  $K_p$ , is given as a function of the RMS load current,  $I_b$ , in percent of the rated current.

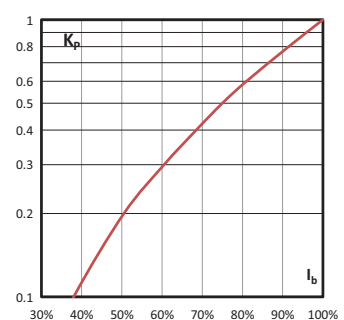

# Square body fuse links

## 170M - Sizes 1\* to 3, French style, 690 V a.c. (IEC), 700 V a.c. (UL), 40 A to 1600 A

### Time-current curve - Size 2, 400 A to 1000 A

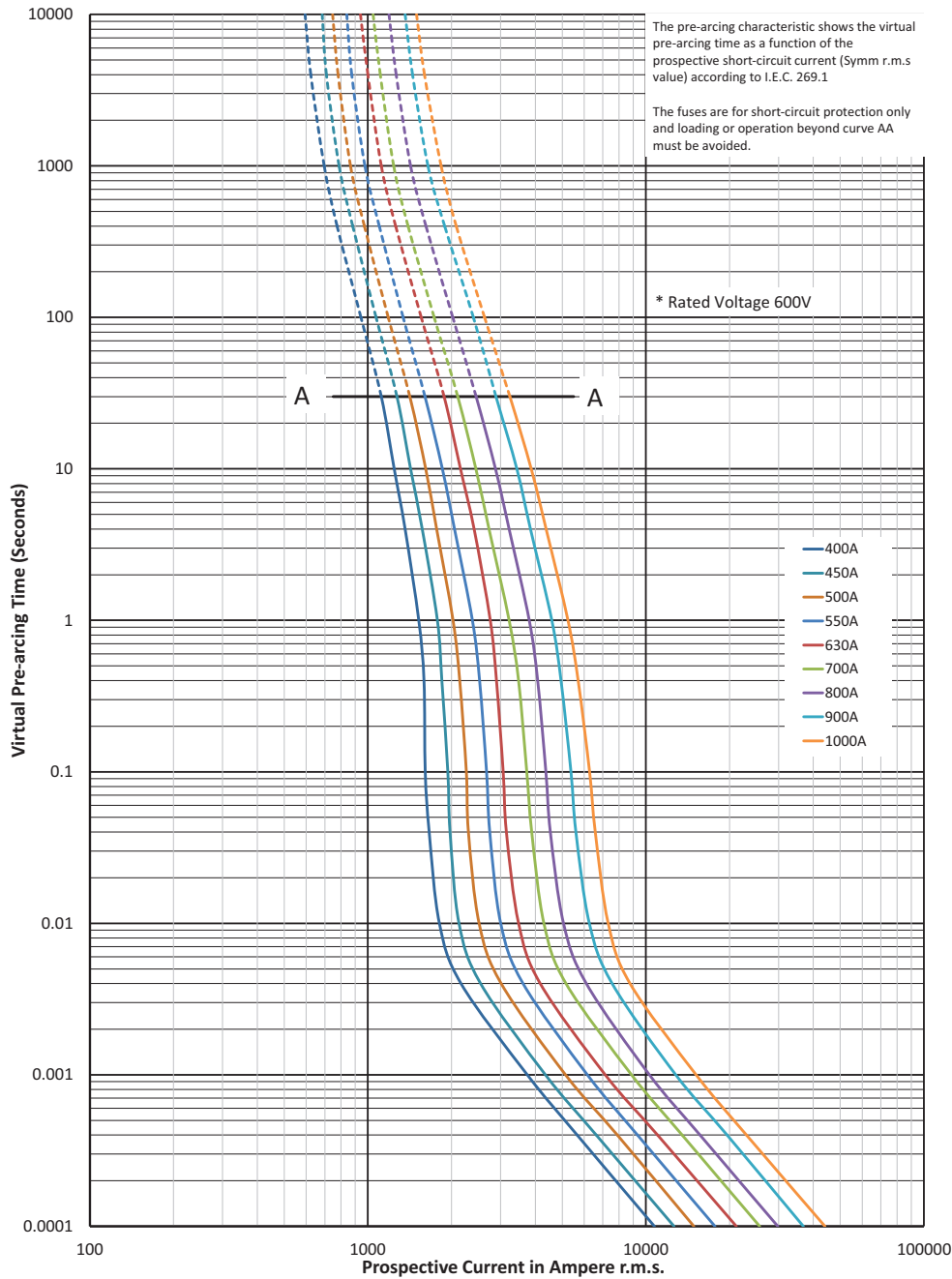

$K_b = 1$   $N = 1.5$



**170M - Sizes 1\* to 3, French style, 690 V a.c. (IEC), 700 V a.c. (UL), 40 A to 1600 A**

**Cut-off curve - Size 2, 400 A to 1000 A**

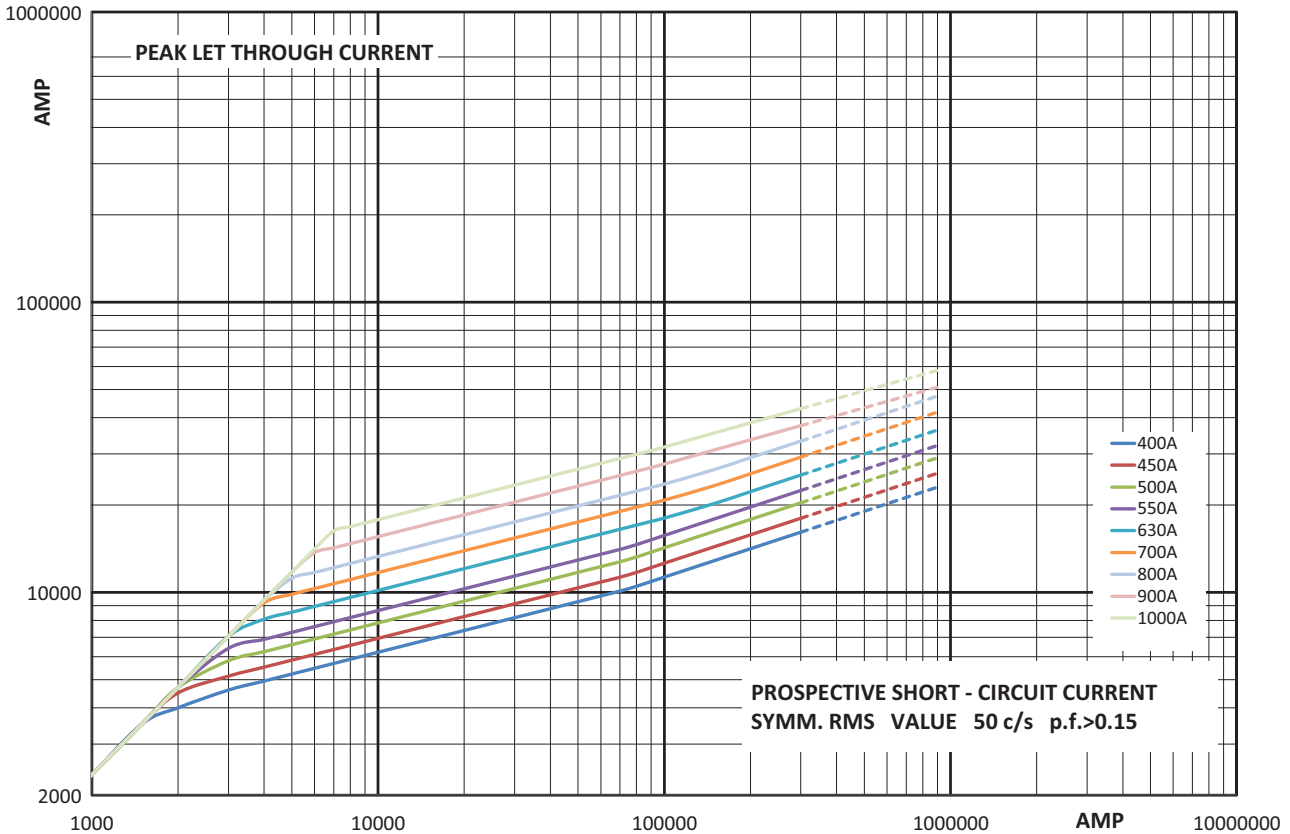

**Total clearing I<sup>2</sup>t**

The total clearing I<sup>2</sup>t at rated voltage and at a power factor of 15 percent are given in the electrical characteristics. For other voltages, the clearing I<sup>2</sup>t is found by multiplying by correction factor, K, given as a function of applied working voltage, E<sub>g</sub>, (RMS).

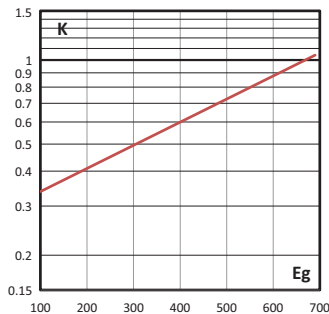

**Arc voltage**

This curve gives the peak arc voltage, U<sub>L</sub>, which may appear across the fuse during its operation as a function of the applied working voltage, E<sub>g</sub>, (RMS) at a power factor of 15 percent.

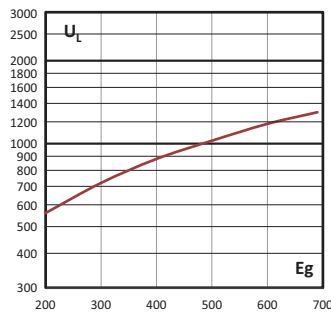

**Watts losses**

Watts loss at rated current is given in the electrical characteristics. The curve allows the calculation of the watts losses at load currents lower than the rated current. The correction factor, K<sub>p</sub>, is given as a function of the RMS load current, I<sub>b</sub>, in percent of the rated current.

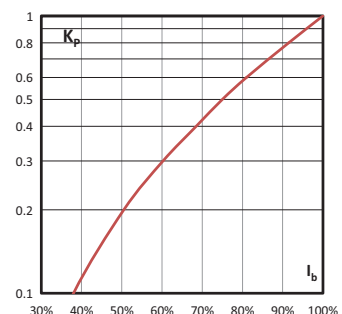

# Square body fuse links

## 170M - Sizes 1\* to 3, French style, 690 V a.c. (IEC), 700 V a.c. (UL), 40 A to 1600 A

### Time-current curve - Size 3, 500 A to 1600 A

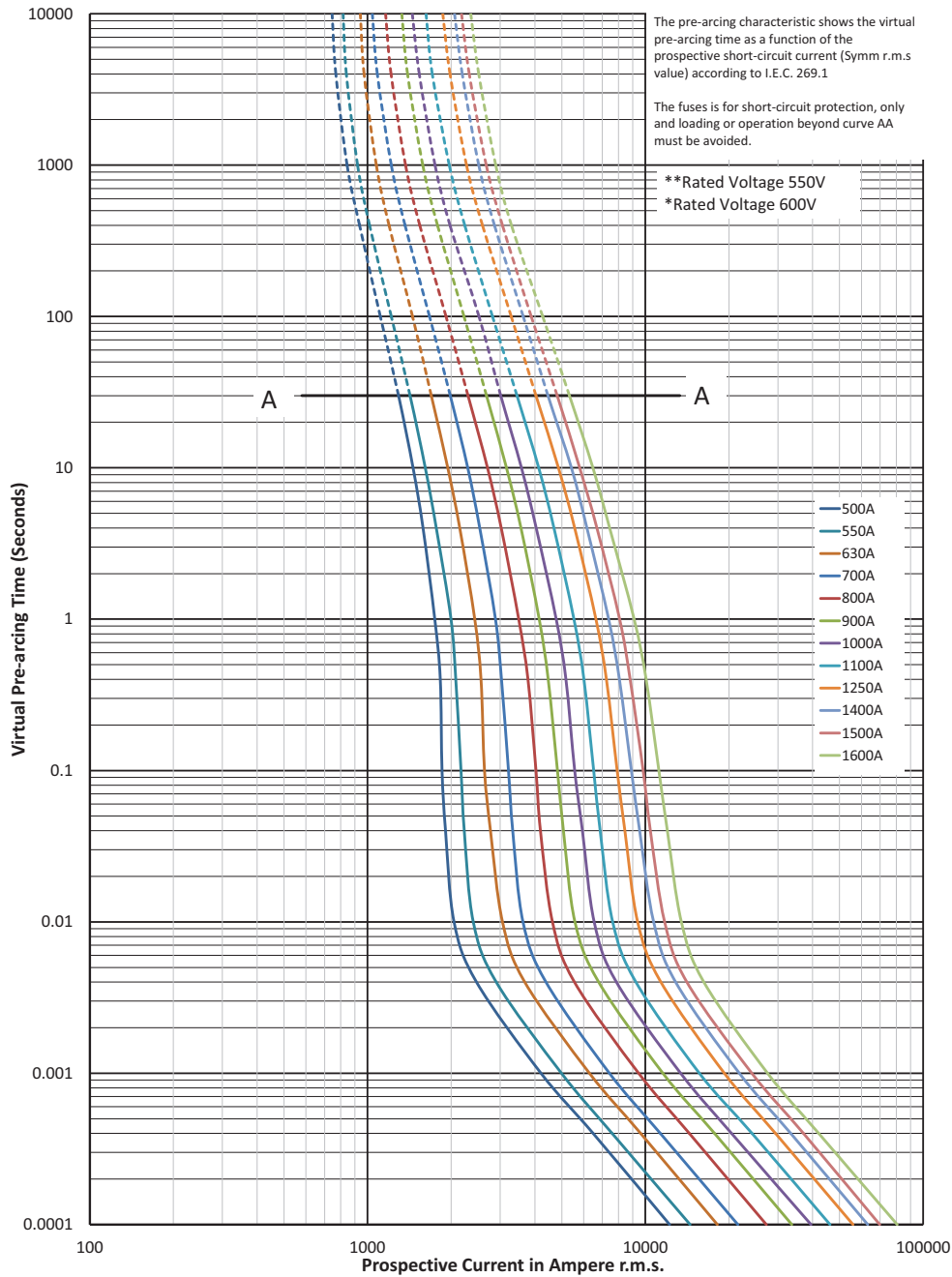

$K_b = 1$     $N = 1.5$

Data sheets: 170K6314 (Size 1\*), 170K6316 (Size 1), 170K6318 (Size 2), 170K6320 (Size 3)

**170M - Sizes 1\* to 3, French style, 690 V a.c. (IEC), 700 V a.c. (UL), 40 A to 1600 A**

**Cut-off curve - Size 3, 500 A to 1600 A**

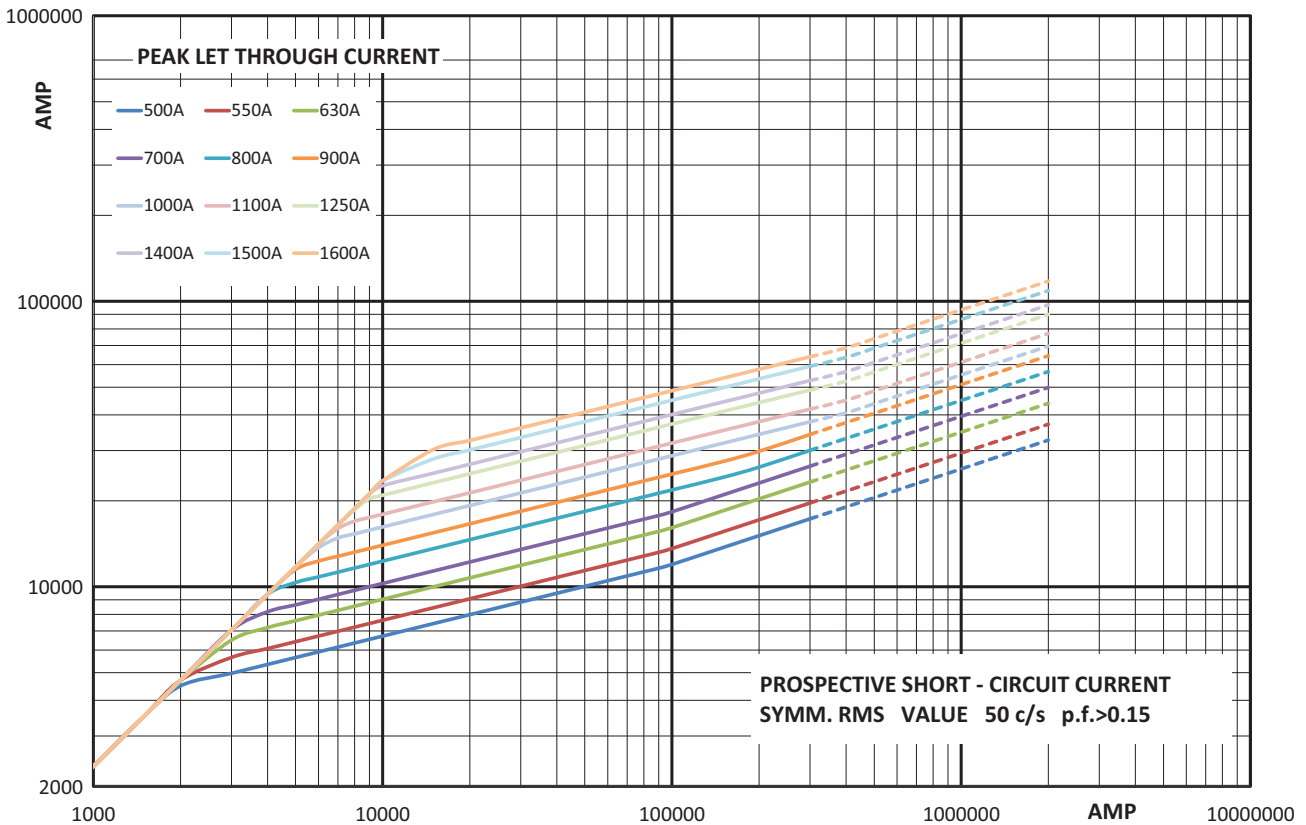

**Total clearing I<sup>2</sup>t**

The total clearing I<sup>2</sup>t at rated voltage and at a power factor of 15 percent are given in the electrical characteristics. For other voltages, the clearing I<sup>2</sup>t is found by multiplying by correction factor, K, given as a function of applied working voltage, E<sub>g</sub>, (RMS).

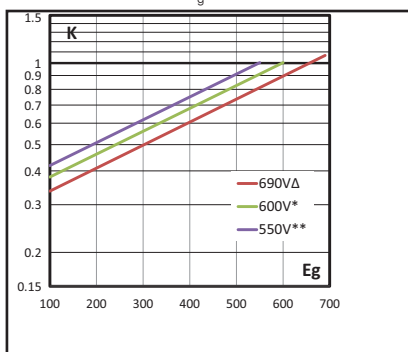

**Arc voltage**

This curve gives the peak arc voltage, U<sub>L</sub>, which may appear across the fuse during its operation as a function of the applied working voltage, E<sub>g</sub>, (RMS) at a power factor of 15 percent.

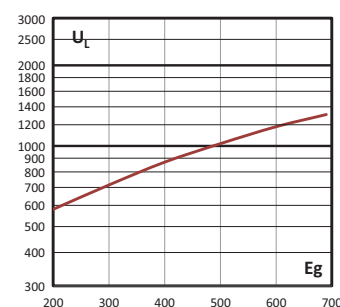

**Watts losses**

Watts loss at rated current is given in the electrical characteristics. The curve allows the calculation of the watts losses at load currents lower than the rated current. The correction factor, K<sub>p</sub>, is given as a function of the RMS load current, I<sub>b</sub>, in percent of the rated current.

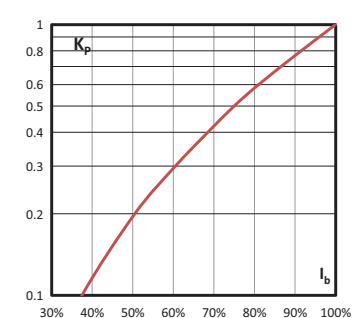

# Square body fuse links

## 170M - Sizes 1\* to 3, US style, 690 V a.c. (IEC), 700 V a.c. (UL), 40 A to 2000 A

### Specifications

#### Description

Square body US style bolted tags high speed fuse links for the protection of DC common bus, DC drives, power converters/rectifiers and reduced rated voltage starters.

#### Technical data

- Rated voltage: see table page 159
- Rated current: 40 A to 2000 A
- Breaking capacity: 200 kA RMS Sym
- Operating class: aR

#### Standards / Agency information

CE, Designed and tested to IEC60269 Part 4. Consult Eaton for UL Recognition/CSA Component Acceptance status and CCC approvals



#### Dimensions (mm)

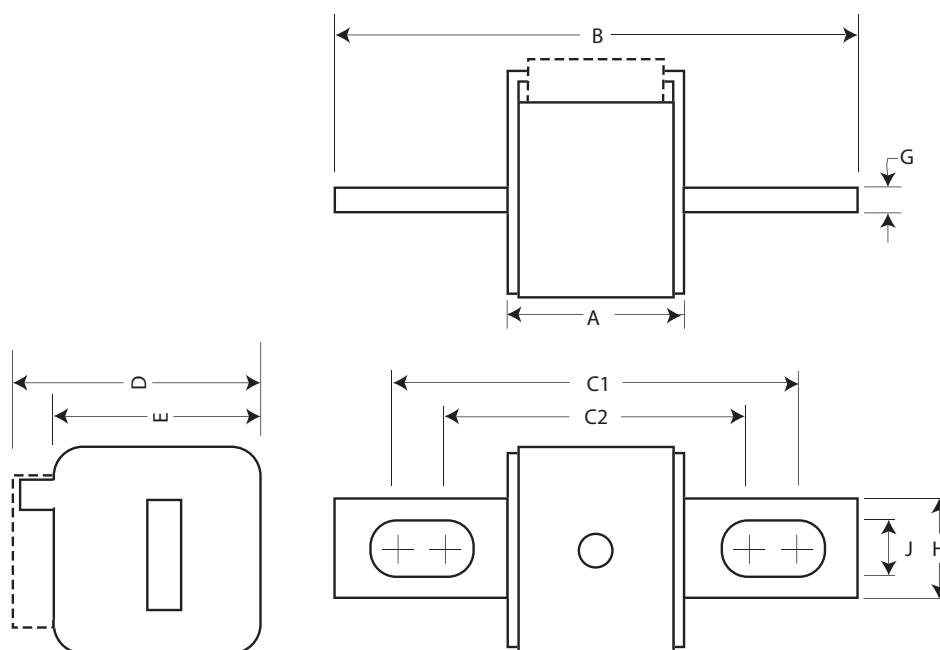

Size	A	B	B1	C1	C1'	C2	C2'	D	E	G	H	J
1*	50	110	148	85	123	72	110	59	45	6	20	10
1	50	136	157	104	126	78	100	69	53	6	25	14
2	50	135	159	105	125	78	99	77	61	6	25	14
3	51	135	155	106	125	77	97	92	76	6	36	16

<sup>1</sup> Valid for fuse links type -FU/115 & -FKE/115.

1mm = 0.0394"

**170M - Sizes 1\* to 3, US style, 690 V a.c. (IEC), 700 V a.c. (UL), 40 A to 2000 A**

Fuse link body size	Rated voltage	Rated current (Amps)	I <sup>2</sup> t (A <sup>2</sup> Sec)			Catalogue numbers			
			Pre-arcing	Clearing at 660 V a.c.	Watts loss (W)	-FU/- without indicator	-FKE/- Type K indicator for micro	-FU/115 without indicator	-FKE/115 Type K indicator for micro
1*	690 V a.c. (IEC) 700 V a.c. (UL)	40	40	270	9	170M3608	170M3658	170M3708	170M3758
		50	70	515	11	170M3609	170M3659	170M3709	170M3759
		63	115	770	14	170M3610	170M3660	170M3710	170M3760
		80	185	1250	18	170M3611	170M3661	170M3711	170M3761
		100	360	2450	21	170M3612	170M3662	170M3712	170M3762
		125	550	3700	26	170M3613	170M3663	170M3713	170M3763
		160	1100	7500	30	170M3614	170M3664	170M3714	170M3764
		200	2200	15,000	35	170M3615	170M3665	170M3715	170M3765
		250	4200	28,500	40	170M3616	170M3666	170M3716	170M3766
		315	7000	46,500	50	170M3617	170M3667	170M3717	170M3767
		350	10,000	68,500	55	170M3618	170M3668	170M3718	170M3768
		400	15,000	105,000	60	170M3619	170M3669	170M3719	170M3769
		450	21,000	140,000	65	170M3620	170M3670	170M3720	170M3770
		500	27,000	180,000	70	170M3621	170M3671	170M3721	170M3771
		550	34,000	230,000	75	170M3622	170M3672	170M3722	170M3772
630	48,500	325,000	80	170M3623	170M3673	170M3723	170M3773		
1	690 V a.c. (IEC) 700 V a.c. (UL)	200	1650	11,500	45	170M4608	170M4658	170M4708	170M4758
		250	3100	21,000	55	170M4609	170M4659	170M4709	170M4759
		315	6200	42,000	58	170M4610	170M4660	170M4710	170M4760
		350	8500	59,000	60	170M4611	170M4661	170M4711	170M4761
		400	13,500	91,500	65	170M4612	170M4662	170M4712	170M4762
		450	17,000	120,000	70	170M4613	170M4663	170M4713	170M4763
		500	25,000	170,000	72	170M4614	170M4664	170M4714	170M4764
		550	34,000	230,000	75	170M4615	170M4665	170M4715	170M4765
		630	52,000	350,000	80	170M4616	170M4666	170M4716	170M4766
		700	69,500	465,000	85	170M4617	170M4667	170M4717	170M4767
800	105,000	725,000	95	170M4618	170M4668	170M4718	170M4768		
550 V a.c. (IEC)	900	155,000	850,000	100	170M4619	170M4669	170M4719	170M4769	
2	690 V a.c. (IEC) 700 V a.c. (UL)	400	11,000	74,000	65	170M5608	170M5658	170M5708	170M5758
		450	15,500	105,000	70	170M5609	170M5659	170M5709	170M5759
		500	21,500	145,000	75	170M5610	170M5660	170M5710	170M5760
		550	28,000	190,000	80	170M5611	170M5661	170M5711	170M5761
		630	41,000	275,000	90	170M5612	170M5662	170M5712	170M5762
		700	60,500	405,000	95	170M5613	170M5663	170M5713	170M5763
		800	86,000	575,000	105	170M5614	170M5664	170M5714	170M5764
		900	125,000	840,000	110	170M5615	170M5665	170M5715	170M5765
		1000	180,000	1,250,000	115	170M5616	170M5666	170M5716	170M5766
		600 V a.c. (IEC) 700 V a.c. (UL)	1100	245,000	1,600,000	120	170M5617	170M5667	170M5717
1250	365,000	2,400,000	130	170M5618	170M5668	170M5718	170M5768		
3	690 V a.c. (IEC) 700 V a.c. (UL)	500	14,000	95,000	95	170M6608	170M6658	170M6708	170M6758
		550	19,500	135,000	100	170M6609	170M6659	170M6709	170M6759
		630	31,000	210,000	105	170M6610	170M6660	170M6710	170M6760
		700	44,500	300,000	110	170M6611	170M6661	170M6711	170M6761
		800	69,500	465,000	115	170M6612	170M6662	170M6712	170M6762
		900	100,000	670,000	120	170M6613	170M6663	170M6713	170M6763
		1000	140,000	945,000	125	170M6614	170M6664	170M6714	170M6764
		1100	190,000	1,300,000	130	170M6615	170M6665	170M6715	170M6765
		1250	290,000	1,950,000	140	170M6616	170M6666	170M6716	170M6766
		1400	370,000	2,450,000	155	170M6617	170M6667	170M6717	170M6767
		1500	460,000	3,100,000	160	170M6618	170M6668	170M6718	170M6768
		1600	580,000	3,900,000	160	170M6619	170M6669	170M6719	170M6769
		600 V a.c. (IEC) 550 V a.c. (UL)	1800	880,000	5,250,000	165	170M6620 <sup>3</sup>	170M6670 <sup>1</sup>	170M6720 <sup>3</sup>
550 V a.c. (IEC) 500 V a.c. (UL)	2000	1,150,000	6,350,000	175	170M6621	170M6671 <sup>2</sup>	170M6721	170M6771	

<sup>1</sup> 170M6670 600 V a.c. (UL)/550 V a.c. (IEC)    <sup>2</sup> 170M6671 550 V a.c. (IEC and UL)    <sup>3</sup> Rated at 750 V d.c. 12XIn 130 kA when two fuses are connected in series

Data sheets: 170K6314 (Size 1\*), 170K6316 (Size 1), 170K6318 (Size 2), 170K6320 (Size 3)

# Square body fuse links

## 170M - Sizes 1\* to 3, US style, 690 V a.c. (IEC), 700 V a.c. (UL), 40 A to 2000 A

### Time-current curve - Size 1\*, 40 A to 630 A

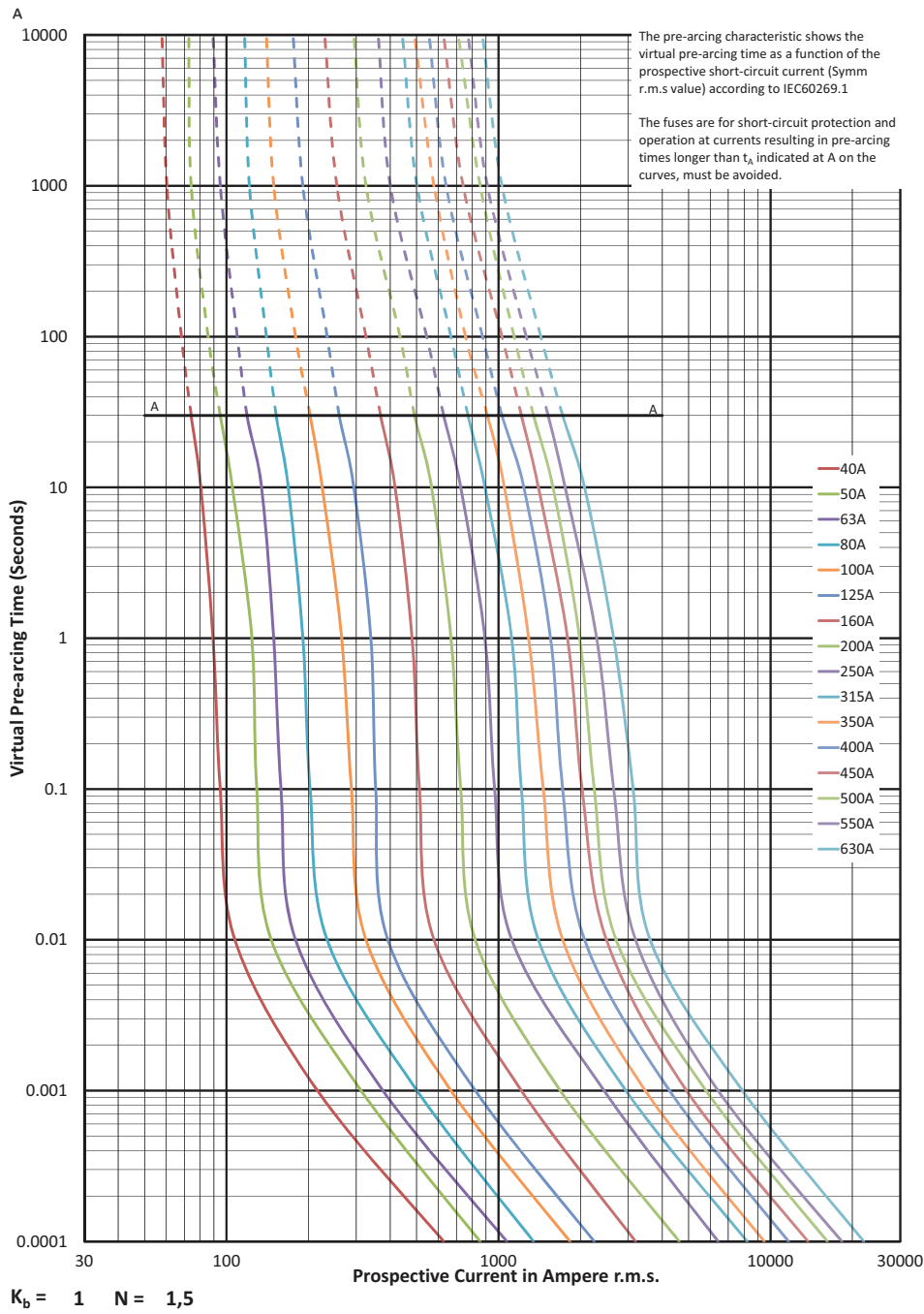

Data sheets: 170K6314 (Size 1\*), 170K6316 (Size 1), 170K6318 (Size 2), 170K6320 (Size 3)

**170M - Sizes 1\* to 3, US style, 690 V a.c. (IEC), 700 V a.c. (UL), 40 A to 2000 A**

**Cut-off curve - Size 1\*, 40 A to 630 A**

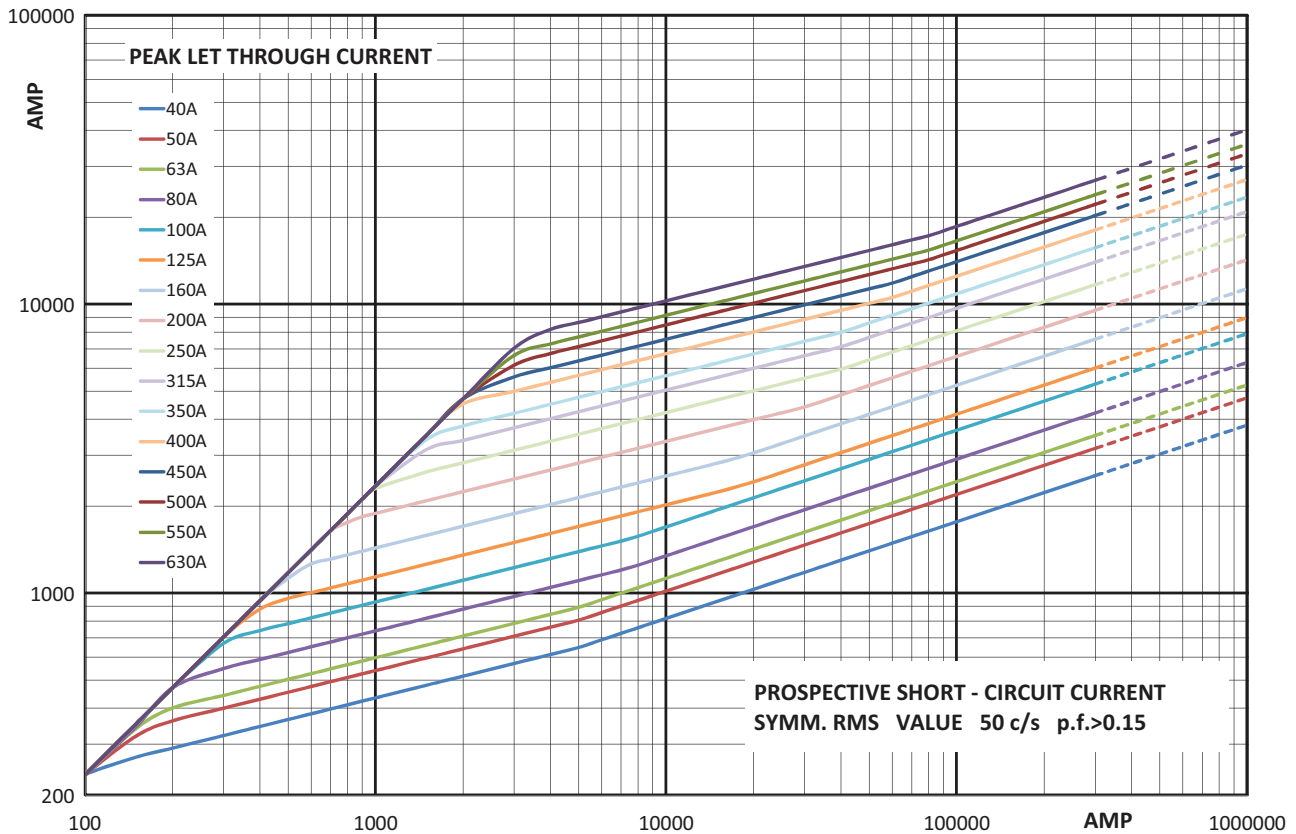

**Total clearing  $I^2t$**

The total clearing  $I^2t$  at rated voltage and at a power factor of 15 percent are given in the electrical characteristics. For other voltages, the clearing  $I^2t$  is found by multiplying by correction factor,  $K$ , given as a function of applied working voltage,  $E_g$ , (RMS).

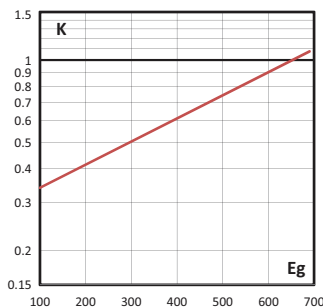

**Arc voltage**

This curve gives the peak arc voltage,  $U_L$ , which may appear across the fuse during its operation as a function of the applied working voltage,  $E_g$ , (RMS) at a power factor of 15 percent.

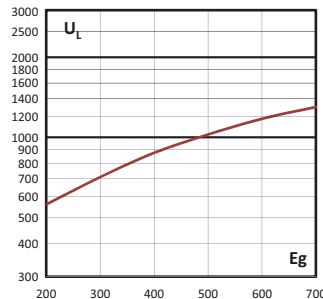

**Watts losses**

Watts loss at rated current is given in the electrical characteristics. The curve allows the calculation of the watts losses at load currents lower than the rated current. The correction factor,  $K_p$ , is given as a function of the RMS load current,  $I_b$ , in percent of the rated current.

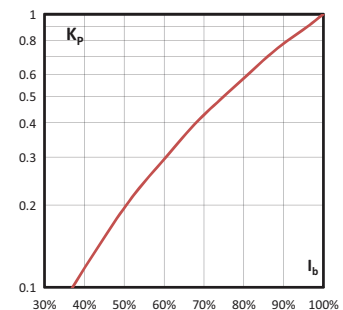

# Square body fuse links

## 170M - Sizes 1\* to 3, US style, 690 V a.c. (IEC), 700 V a.c. (UL), 40 A to 2000 A

### Time-current curve - Size 1, 200 A to 900 A

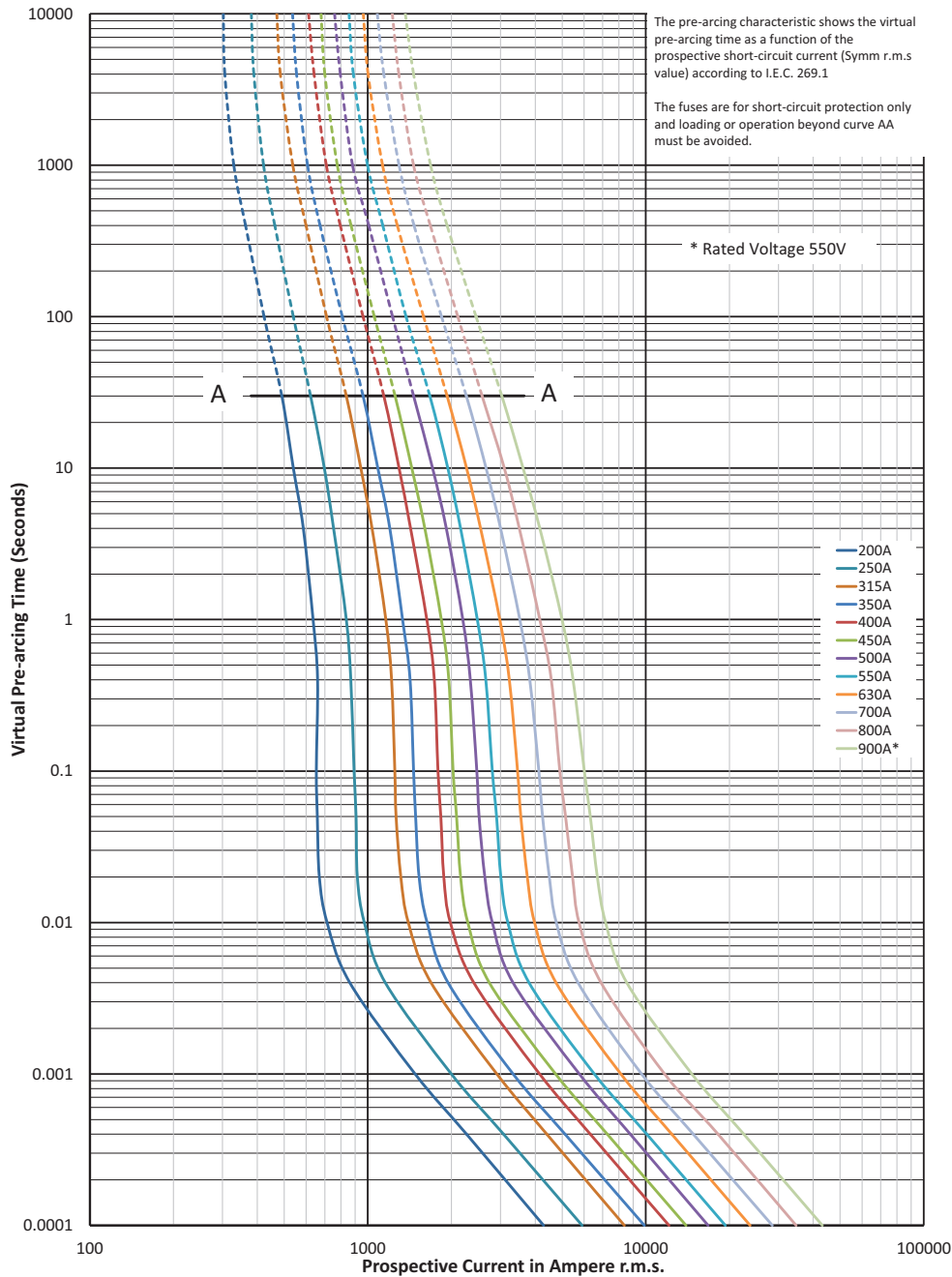

$K_b = 1$   $N = 1.5$

Data sheets: 170K6314 (Size 1\*), 170K6316 (Size 1), 170K6318 (Size 2), 170K6320 (Size 3)



**170M - Sizes 1\* to 3, US style, 690 V a.c. (IEC), 700 V a.c. (UL), 40 A to 2000 A**

**Cut-off curve - Size 1, 200 A to 900 A**

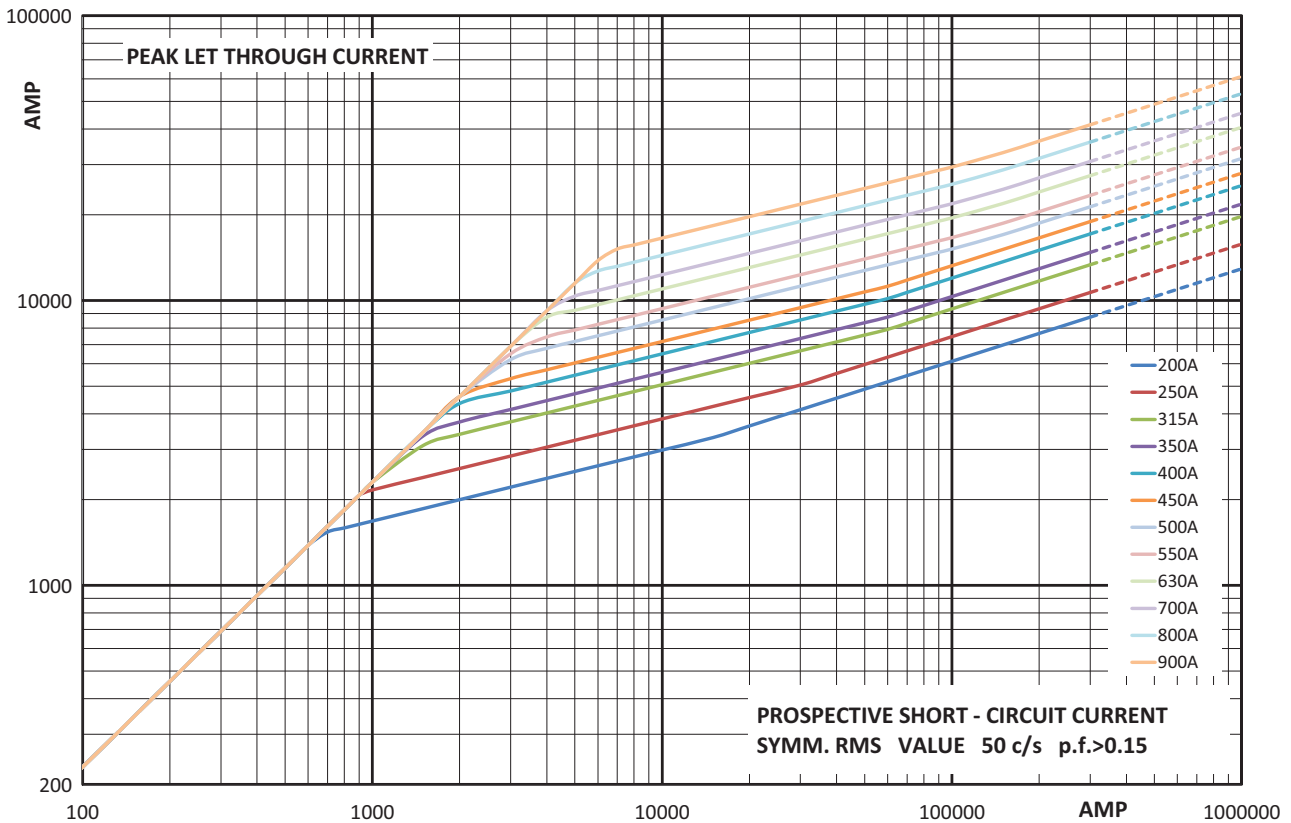

**Total clearing I<sup>2</sup>t**

The total clearing I<sup>2</sup>t at rated voltage and at a power factor of 15 percent are given in the electrical characteristics. For other voltages, the clearing I<sup>2</sup>t is found by multiplying by correction factor, K, given as a function of applied working voltage, E<sub>g</sub>, (RMS).

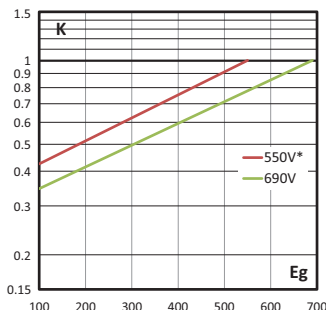

**Arc voltage**

This curve gives the peak arc voltage, U<sub>L</sub>, which may appear across the fuse during its operation as a function of the applied working voltage, E<sub>g</sub>, (RMS) at a power factor of 15 percent.

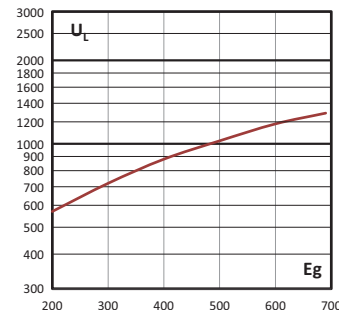

**Watts losses**

Watts loss at rated current is given in the electrical characteristics. The curve allows the calculation of the watts losses at load currents lower than the rated current. The correction factor, K<sub>p</sub>, is given as a function of the RMS load current, I<sub>b</sub>, in percent of the rated current.

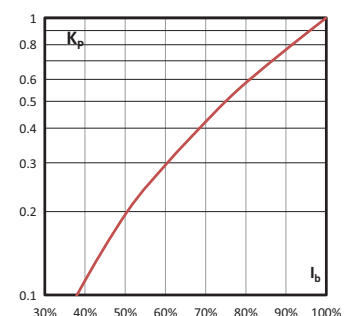

# Square body fuse links

## 170M - Sizes 1\* to 3, US style, 690 V a.c. (IEC), 700 V a.c. (UL), 40 A to 2000 A

### Time-current curve - Size 2, 400 A to 1250 A

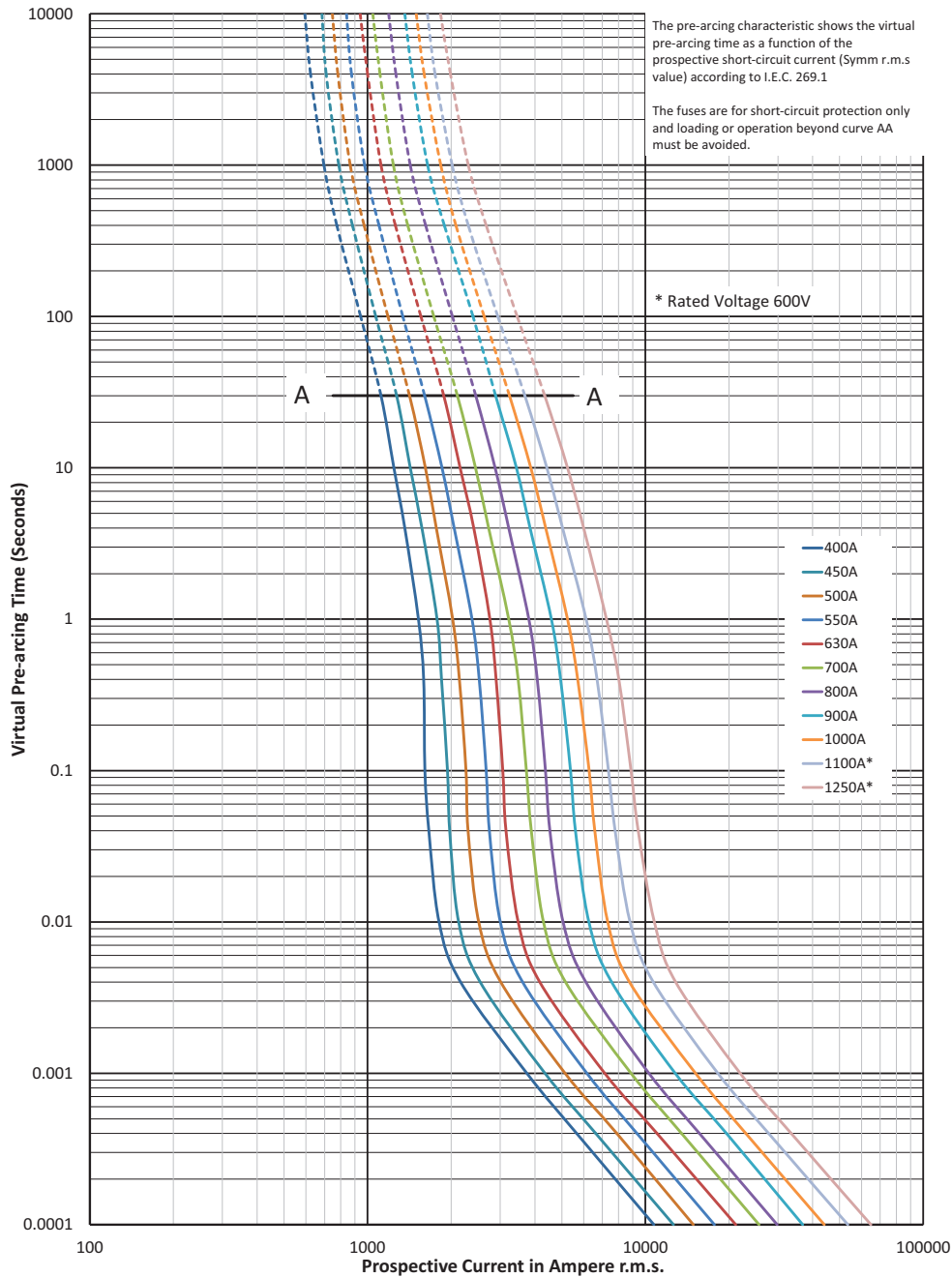

$K_b = 1$   $N = 1.5$

**170M - Sizes 1\* to 3, US style, 690 V a.c. (IEC), 700 V a.c. (UL), 40 A to 2000 A**

**Cut-off curve - Size 2, 400 A to 1250 A**

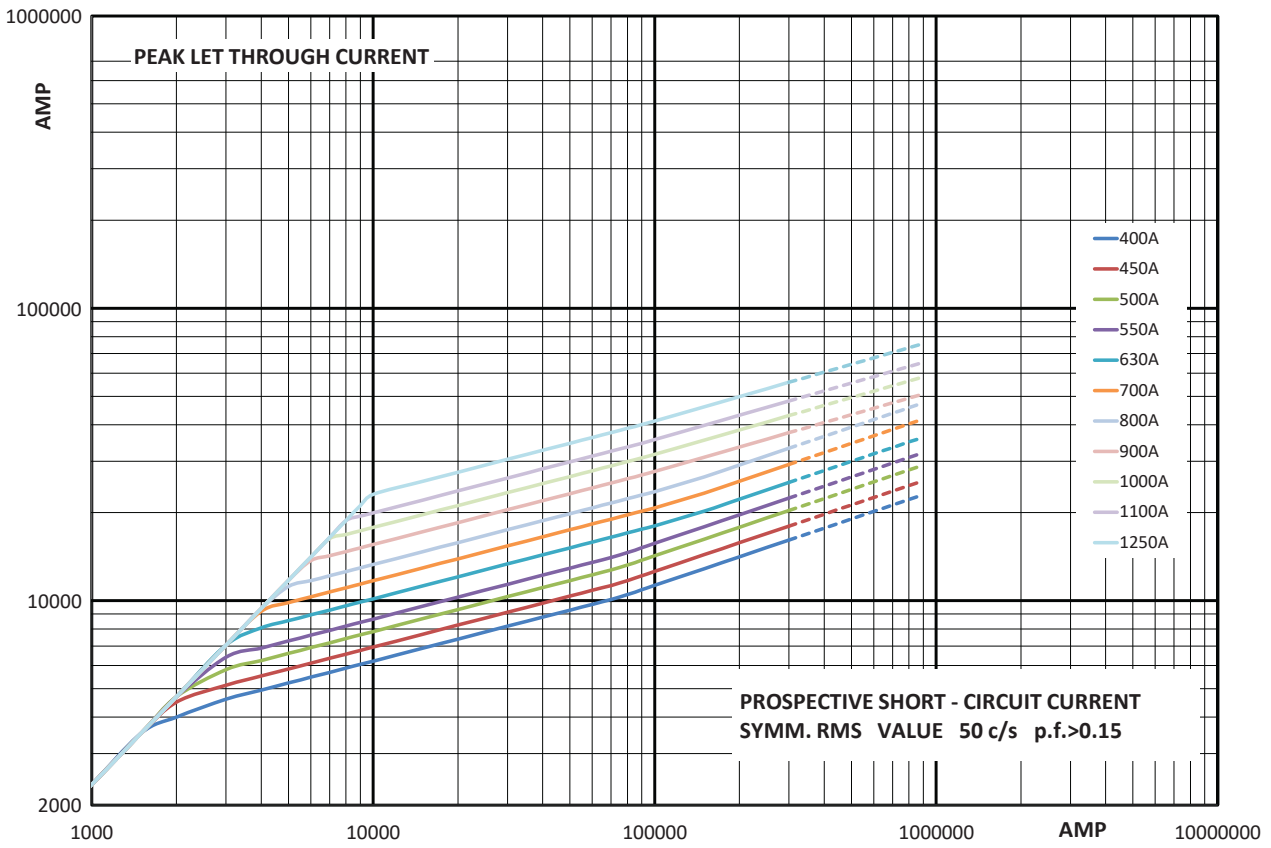

**Total clearing I<sup>2</sup>t**

The total clearing I<sup>2</sup>t at rated voltage and at a power factor of 15 percent are given in the electrical characteristics. For other voltages, the clearing I<sup>2</sup>t is found by multiplying by correction factor, K, given as a function of applied working voltage, E<sub>g</sub>, (RMS).

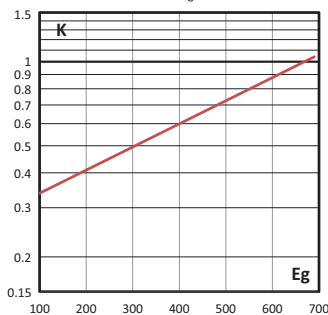

**Arc voltage**

This curve gives the peak arc voltage, U<sub>L</sub>, which may appear across the fuse during its operation as a function of the applied working voltage, E<sub>g</sub>, (RMS) at a power factor of 15 percent.

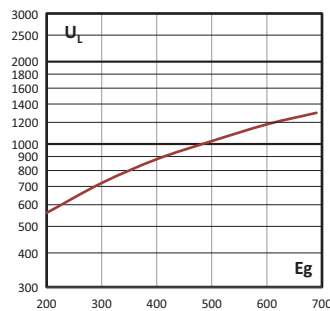

**Watts losses**

Watts loss at rated current is given in the electrical characteristics. The curve allows the calculation of the watts losses at load currents lower than the rated current. The correction factor, K<sub>p</sub>, is given as a function of the RMS load current, I<sub>b</sub>, in percent of the rated current.

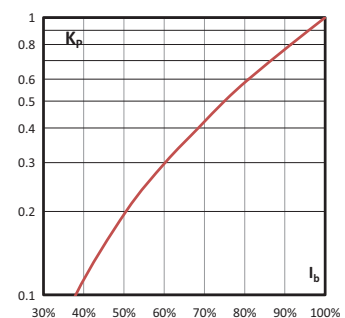

# Square body fuse links

## 170M - Sizes 1\* to 3, US style, 690 V a.c. (IEC), 700 V a.c. (UL), 40 A to 2000 A

### Time-current curve - Size 3, 500 A to 2000 A

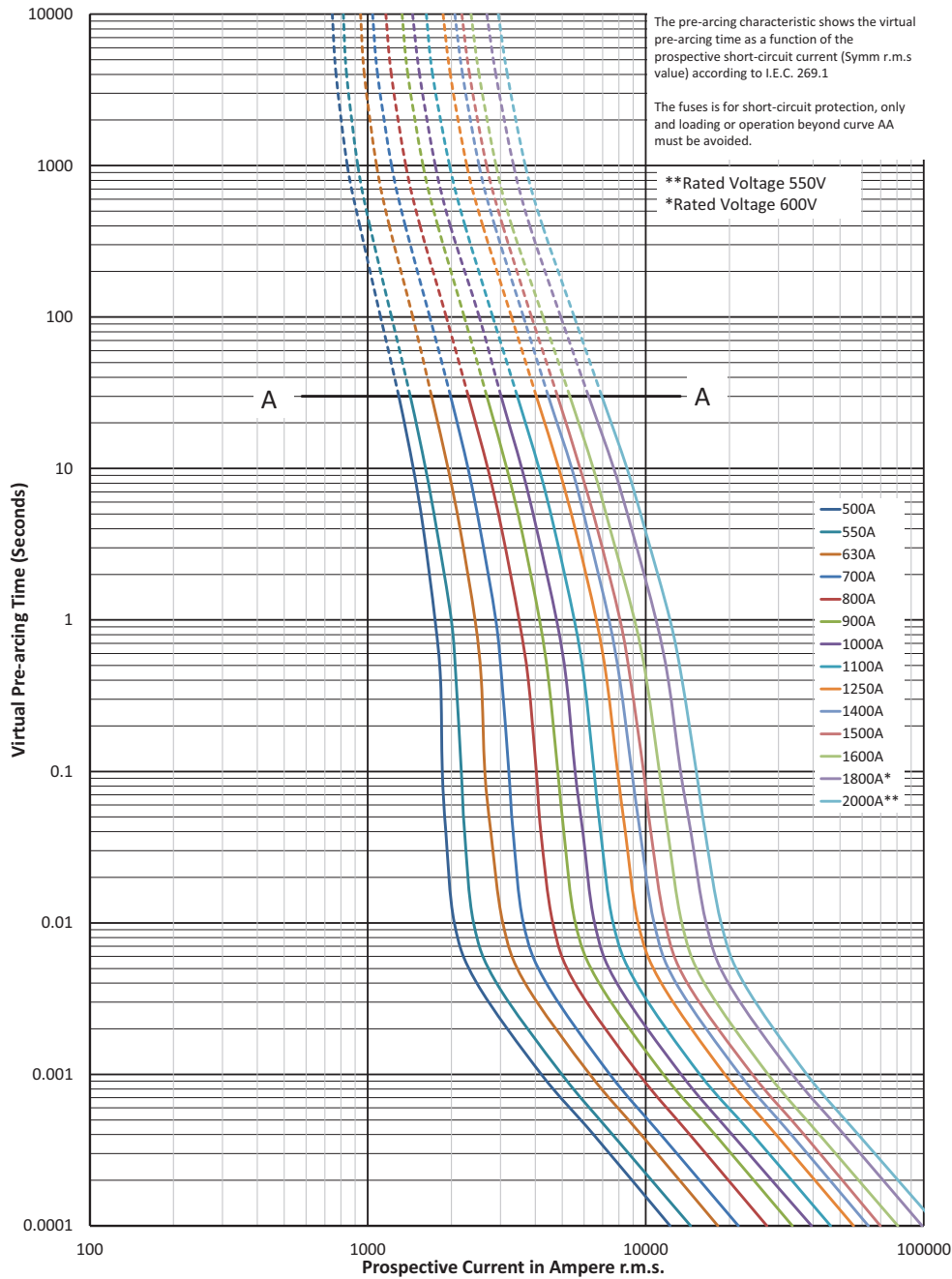

$K_b = 1$   $N = 1.5$

**170M - Sizes 1\* to 3, US style, 690 V a.c. (IEC), 700 V a.c. (UL), 40 A to 2000 A**

**Cut-off curve - Size 3, 500 A to 2000 A**

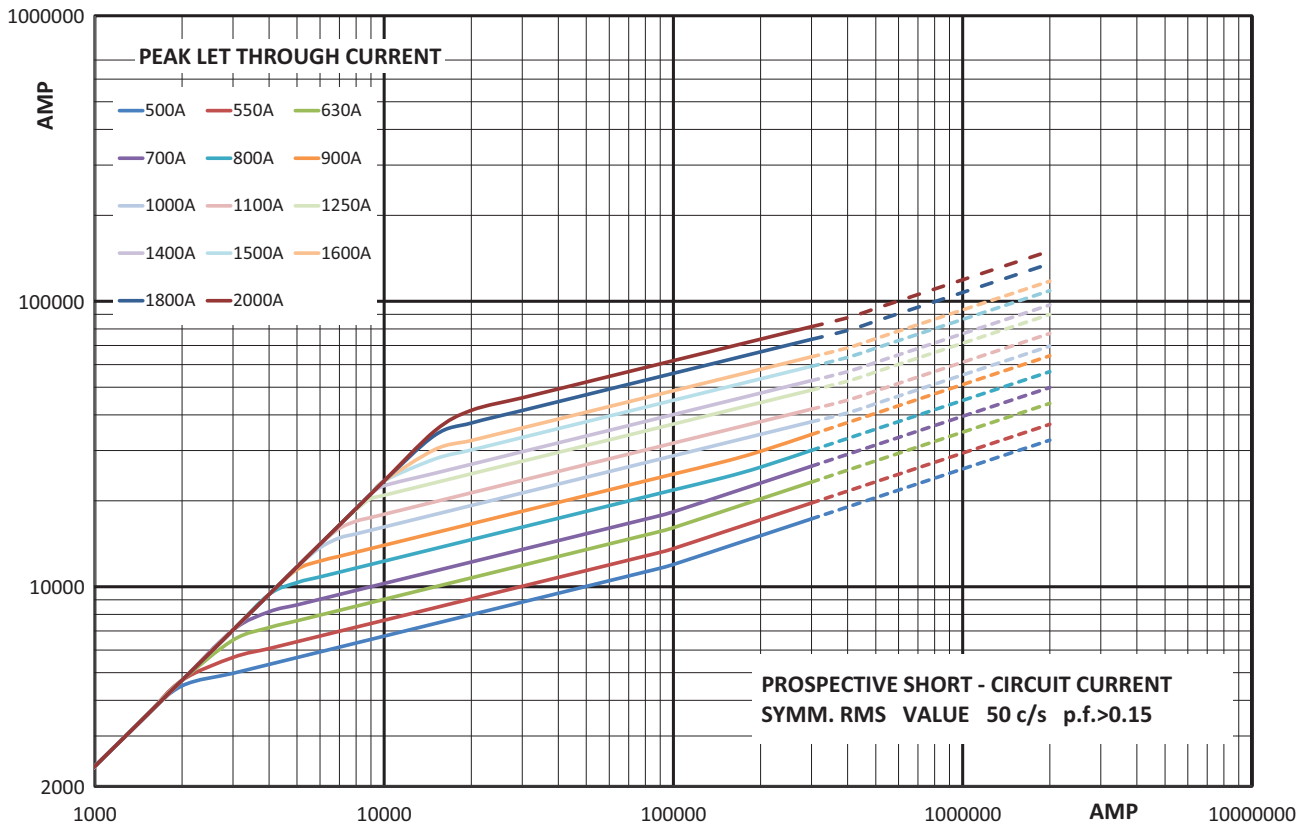

**Total clearing  $I^2t$**

The total clearing  $I^2t$  at rated voltage and at a power factor of 15 percent are given in the electrical characteristics. For other voltages, the clearing  $I^2t$  is found by multiplying by correction factor,  $K$ , given as a function of applied working voltage,  $E_g$  (RMS).

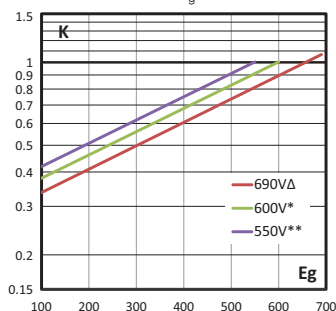

**Arc voltage**

This curve gives the peak arc voltage,  $U_L$ , which may appear across the fuse during its operation as a function of the applied working voltage,  $E_g$  (RMS) at a power factor of 15 percent.

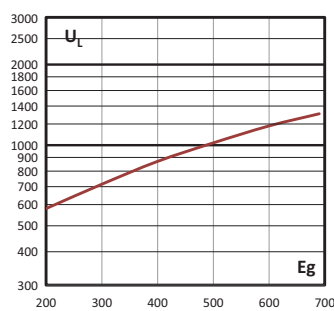

**Watts losses**

Watts loss at rated current is given in the electrical characteristics. The curve allows the calculation of the watts losses at load currents lower than the rated current. The correction factor,  $K_p$ , is given as a function of the RMS load current,  $I_b$ , in percent of the rated current.

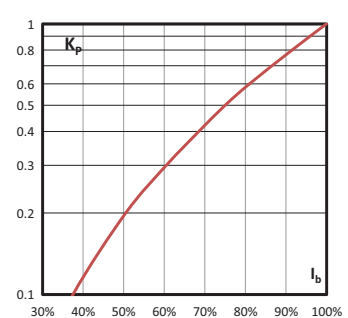

# Square body fuse links

## 170M - Sizes 1\* to 3, US style, 1000 V a.c. (IEC), 50 A to 1400 A

### Specifications

#### Description

Square body US style bolted tags high speed fuse links for the protection of DC common bus, DC drives, power converters/rectifiers and reduced rated voltage starters.

#### Technical data

- Rated voltage: 1000 V a.c. (IEC)
- Rated current: 50 A to 1400 A
- Breaking capacity:
  - 125kA RMS Sym. A.C.
  - Size 1 750 V d.c. 50 kA IR
- Operating class: aR

#### Standards / Agency information

CE, Designed and tested to IEC60269 Part 4. UL Recognised/CSA Component Acceptance status for size 2 and 3 (315 A to 1100 A) and CCC approval for size 2 only.



#### Dimensions (mm)

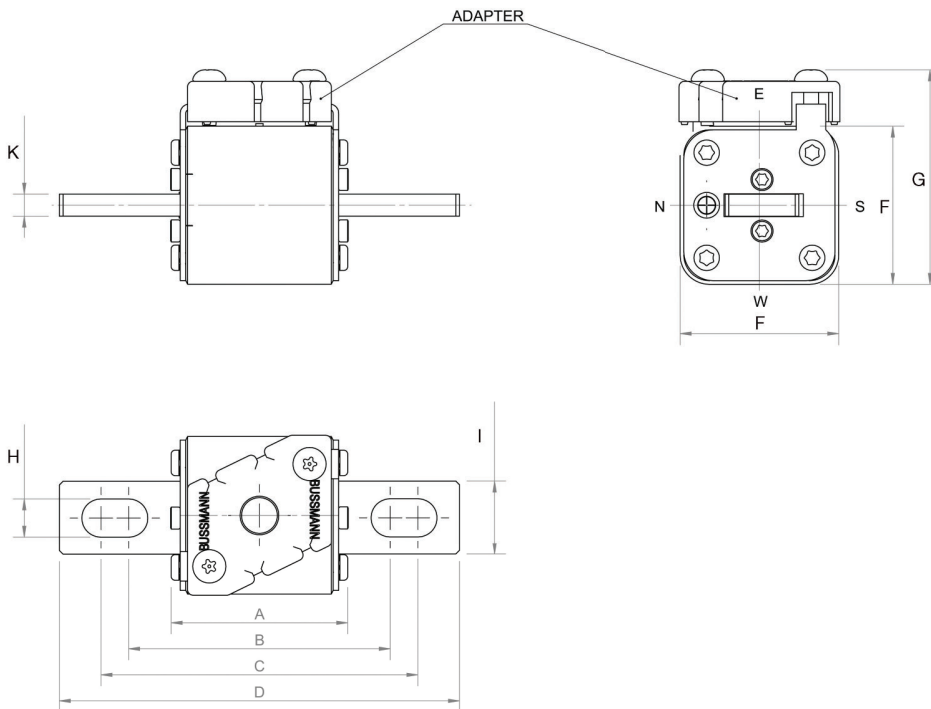

Size	A	B	C	D	F	G	H	I	K
1*FKE/115	74	101	130	156	43	60	10.4	20	6
1FKE/115	76	102	128	160	51	68	14.3	25	6
2FKE/115	76	101.1	127.5	160	59	76	14.4	25	6
3FKE/115	76	101.1	127.5	158	74	91	16	36	6

1mm = 0.0394"

Data sheets: 170K8564 (Size 1\*), 170K8566 (Size 1), 170K8568 (Size 2), 170K8570 (Size 3)

**170M - Sizes 1\* to 3, US style, 1000 V a.c. (IEC), 50 A to 1400 A**

**Catalogue numbers**

Fuse link body size	Rated voltage	Rated current (Amps)	I <sup>2</sup> t (A <sup>2</sup> Sec)		Watts loss (W)	Catalogue numbers -FKE/115 Type K indicator for micro
			Pre-arcing	Clearing at 1000 V a.c.		
1*	1000 V a.c. (IEC)	50	135	815	20	170M3531
		63	215	1300	25	170M3532
		80	460	2750	30	170M3533
		100	860	5100	35	170M3534
		125	1450	8600	40	170M3535
		160	2850	17,500	45	170M3536
		200	4950	29,500	50	170M3537
		250	9550	57,000	55	170M3538
		315	21,500	130,000	65	170M3539
		350	29,000	175,000	70	170M3540
		400	42,000	250,000	75	170M3541
1	1000 V a.c. (IEC)	160	2200	13,500	40	170M4531
		200	4150	24,500	50	170M4532
		250	7750	46,000	55	170M4533
		315	16,500	98,500	65	170M4534
	1000 V a.c. / 750 V d.c. (UL)	350	21,500	130,000	70	170M4535
		400	31,000	185,000	75	170M4536
		450	44,500	265,000	80	170M4537
		500	63,000	375,000	85	170M4538
		550	84,500	500,000	90	170M4539
2	1000 V a.c. (IEC/UL)	630	125,000	755,000	98	170M4540
		250	6750	40,000	65	170M5531
		315	13,500	81,500	75	170M5532
		350	16,500	99,000	80	170M5533
		400	26,000	155,000	85	170M5534
		450	35,500	210,000	90	170M5535
		500	49,500	295,000	95	170M5536
		550	66,000	390,000	100	170M5337
		630	93,500	555,000	110	170M5538
		700	130,000	770,000	115	170M5539
3	1000 V a.c. (IEC/UL)	800	195,000	1,200,000	125	170M5540
		315	9200	54,500	90	170M8531
		350	13,000	77,500	95	170M8532
		400	19,000	115,000	105	170M8533
		450	27,000	160,000	107	170M8534
		500	37,500	225,000	110	170M8535
		550	52,000	310,000	115	170M8536
		630	82,500	490,000	120	170M8537
		700	115,000	700,000	125	170M8538
		800	170,000	1,050,000	135	170M8539
		900	250,000	1,500,000	145	170M8540
		1000	340,000	2,050,000	150	170M8541
		1100	460,000	2,750,000	155	170M8542
		1000 V a.c. (IEC)	1250	575,000	3,400,000	175
900 V a.c. (IEC)	1400	795,000	4,200,000	185	170M8544	

Data sheets: 170K8564 (Size 1\*), 170K8566 (Size 1), 170K8568 (Size 2), 170K8570 (Size 3)

# Square body fuse links

## 170M - Sizes 1\* to 3, US style, 1000 V a.c. (IEC), 50 A to 1400 A

### Time-current curve - Size 1\*, 50 A to 400 A

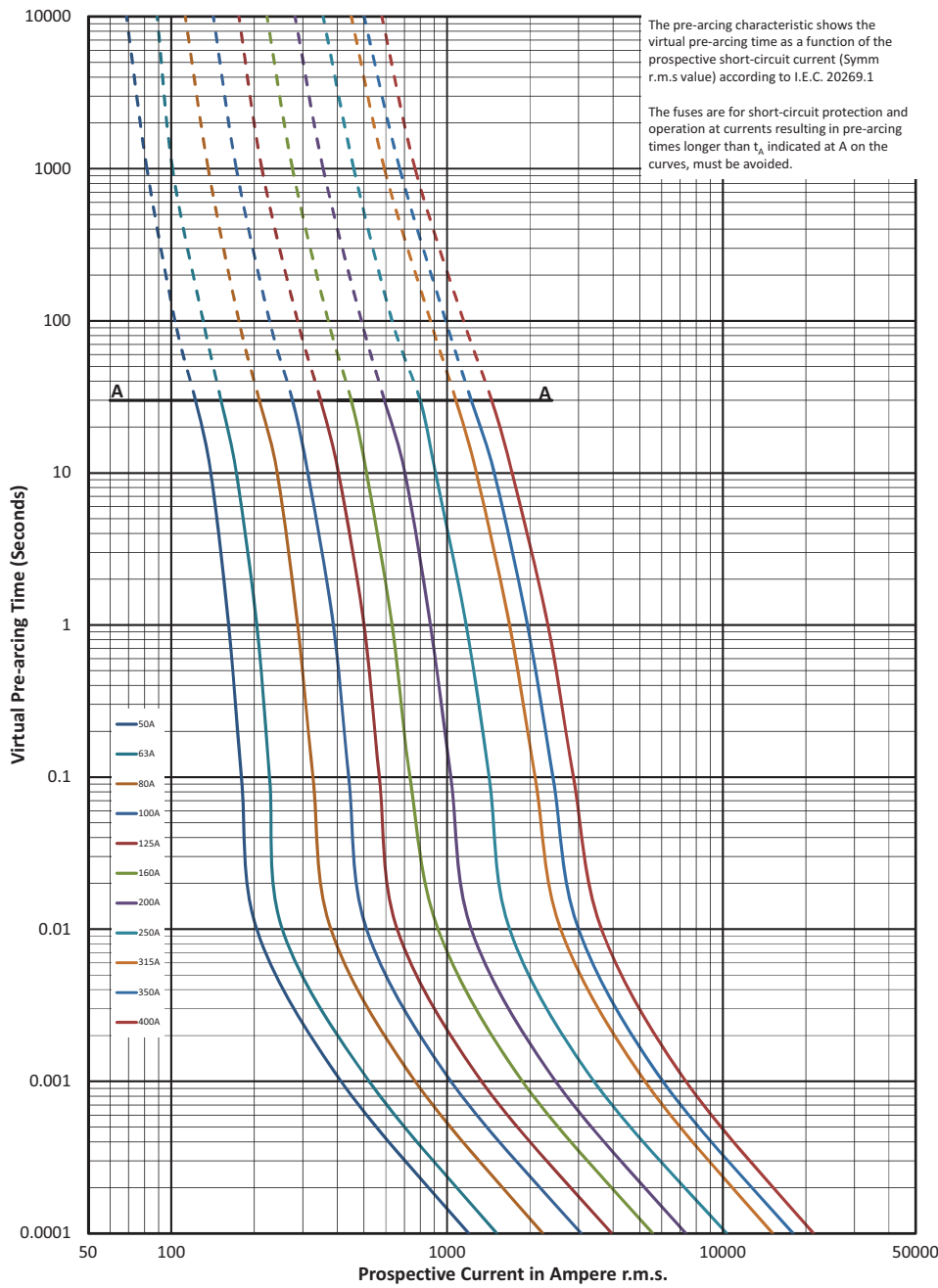

$K_b = 1$     $N = 1,6$



**170M - Sizes 1\* to 3, US style, 1000 V a.c. (IEC), 50 A to 1400 A**

**Cut-off curve - Size 1\*, 50 A to 400 A**

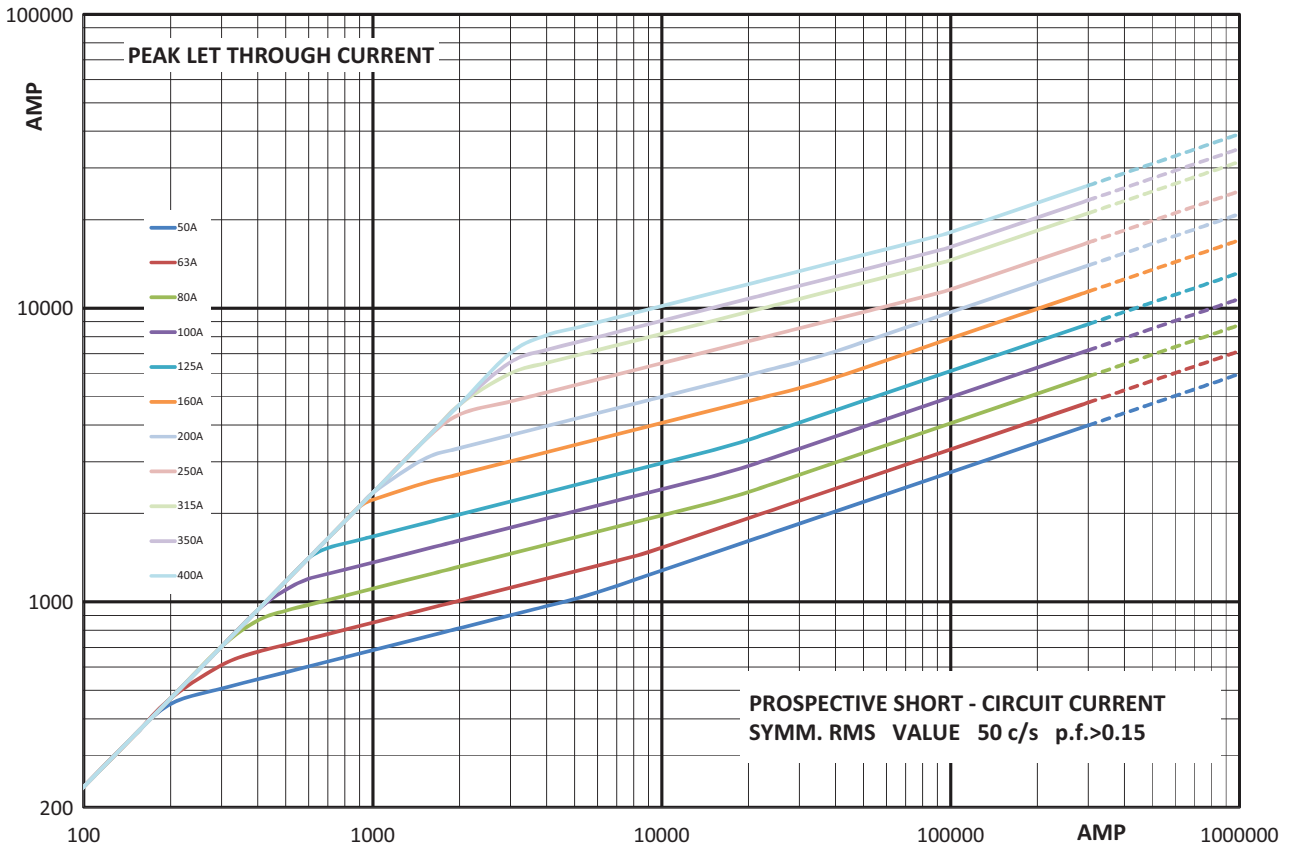

**Total clearing  $I^2t$**

The total clearing  $I^2t$  at rated voltage and at a power factor of 15 percent are given in the electrical characteristics. For other voltages, the clearing  $I^2t$  is found by multiplying by correction factor,  $K$ , given as a function of applied working voltage,  $E_g$ , (RMS).

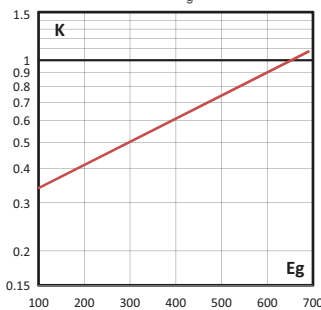

**Arc voltage**

This curve gives the peak arc voltage,  $U_L$ , which may appear across the fuse during its operation as a function of the applied working voltage,  $E_g$ , (RMS) at a power factor of 15 percent.

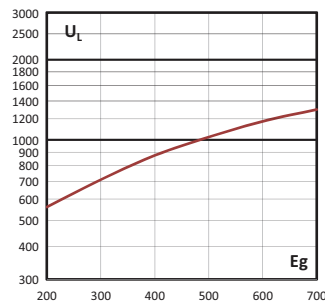

**Watts losses**

Watts loss at rated current is given in the electrical characteristics. The curve allows the calculation of the watts losses at load currents lower than the rated current. The correction factor,  $K_p$ , is given as a function of the RMS load current,  $I_b$ , in percent of the rated current.

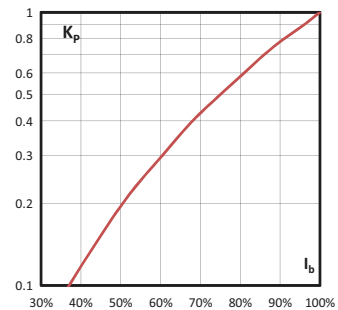

# Square body fuse links

## 170M - Sizes 1\* to 3, US style, 1000 V a.c. (IEC), 50 A to 1400 A

### Time-current curve - Size 1, 160 A to 630 A

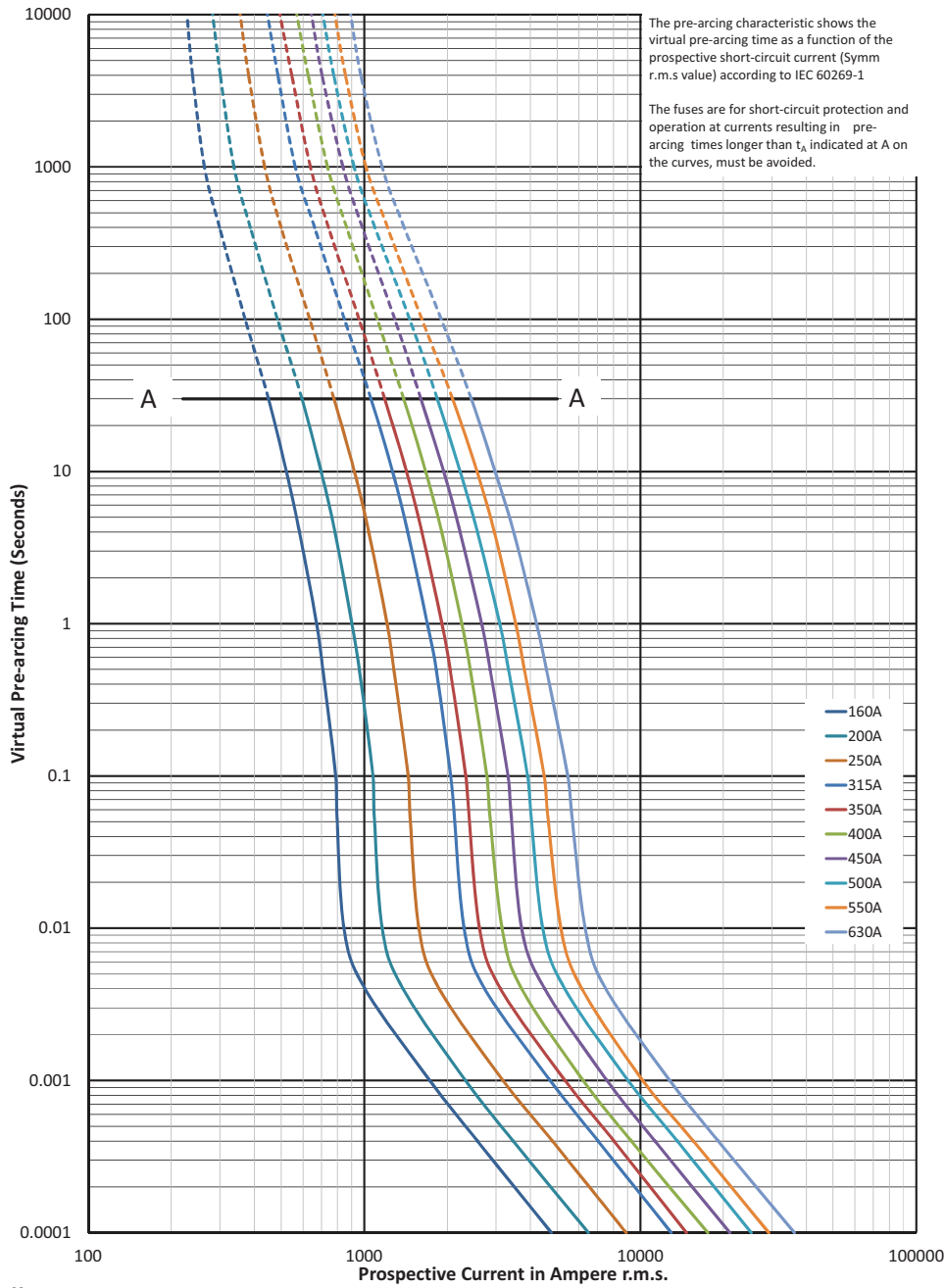

**170M - Sizes 1\* to 3, US style, 1000 V a.c. (IEC), 50 A to 1400 A**

**Cut-off curve - Size 1, 160 A to 630 A**

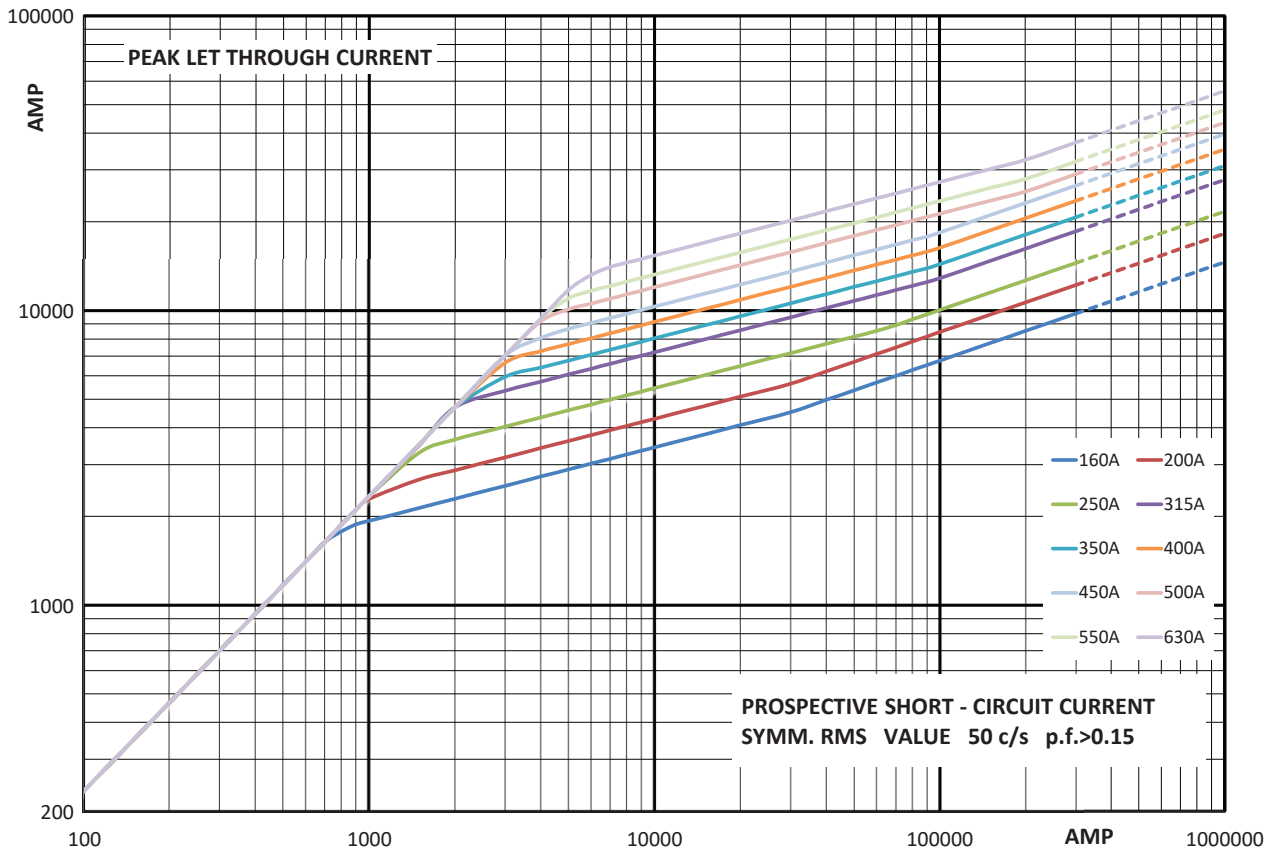

**Total clearing I<sup>2</sup>t**

The total clearing I<sup>2</sup>t at rated voltage and at a power factor of 15 percent are given in the electrical characteristics. For other voltages, the clearing I<sup>2</sup>t is found by multiplying by correction factor, K, given as a function of applied working voltage, E<sub>g</sub>, (RMS).

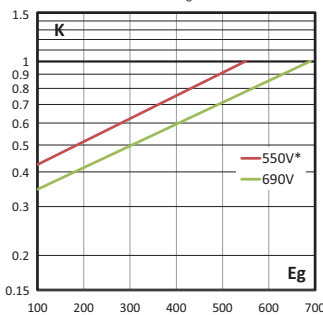

**Arc voltage**

This curve gives the peak arc voltage, U<sub>L</sub>, which may appear across the fuse during its operation as a function of the applied working voltage, E<sub>g</sub>, (RMS) at a power factor of 15 percent.

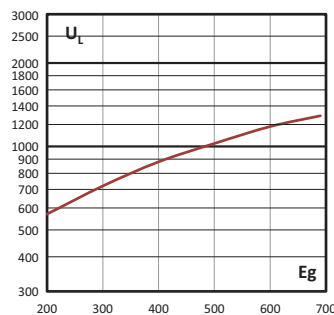

**Watts losses**

Watts loss at rated current is given in the electrical characteristics. The curve allows the calculation of the watts losses at load currents lower than the rated current. The correction factor, K<sub>p</sub>, is given as a function of the RMS load current, I<sub>b</sub>, in percent of the rated current.

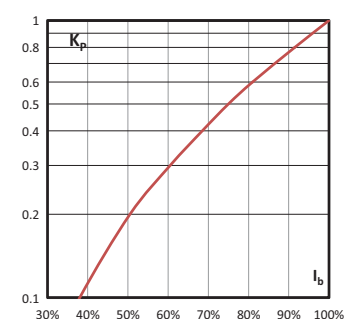

Data sheets: 170K8564 (Size 1\*), 170K8566 (Size 1), 170K8568 (Size 2), 170K8570 (Size 3)

# Square body fuse links

## 170M - Sizes 1\* to 3, US style, 1000 V a.c. (IEC), 50 A to 1400 A

### Time-current curve - Size 2, 250 A to 800 A

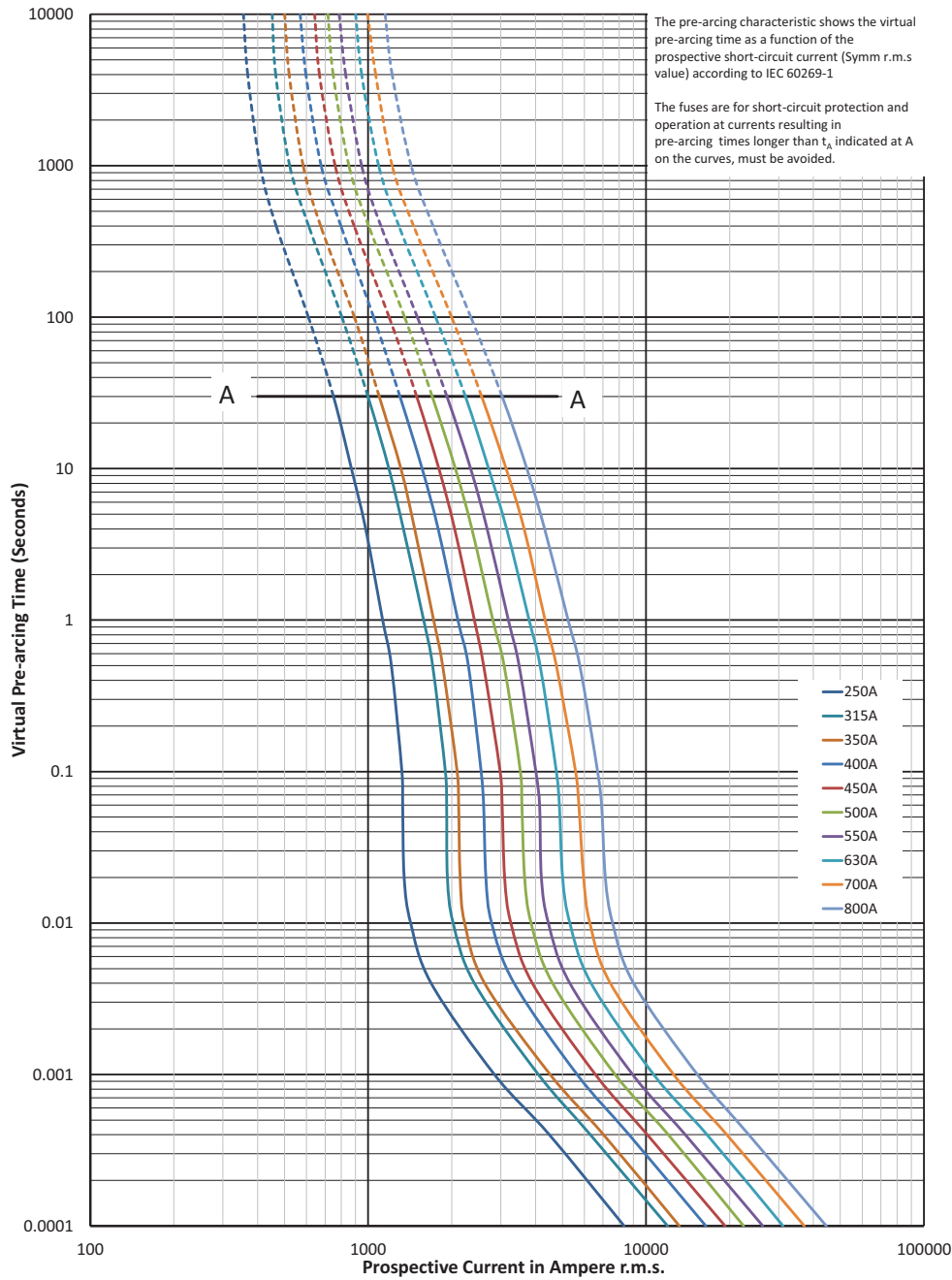

$K_b = 1$   $N = 1.6$

**170M - Sizes 1\* to 3, US style, 1000 V a.c. (IEC), 50 A to 1400 A**

**Cut-off curve - Size 2, 250 A to 800 A**

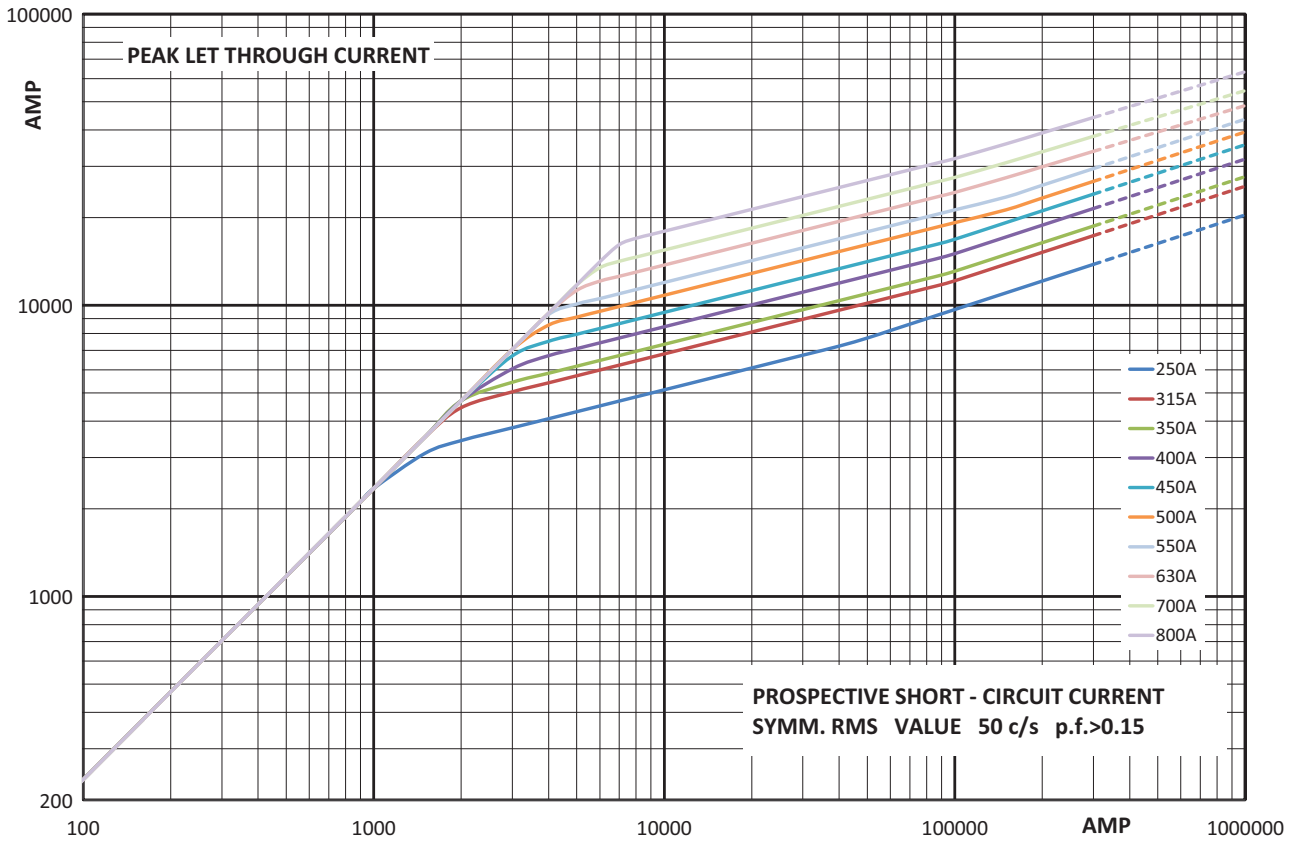

**Total clearing  $I^2t$**

The total clearing  $I^2t$  at rated voltage and at a power factor of 15 percent are given in the electrical characteristics. For other voltages, the clearing  $I^2t$  is found by multiplying by correction factor,  $K$ , given as a function of applied working voltage,  $E_g$ , (RMS).

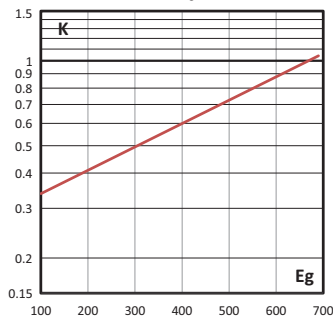

**Arc voltage**

This curve gives the peak arc voltage,  $U_L$ , which may appear across the fuse during its operation as a function of the applied working voltage,  $E_g$ , (RMS) at a power factor of 15 percent.

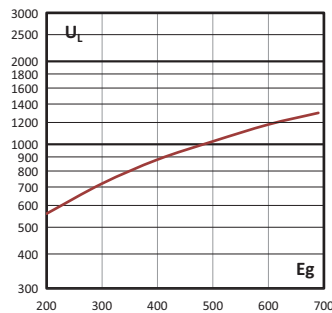

**Watts losses**

Watts loss at rated current is given in the electrical characteristics. The curve allows the calculation of the watts losses at load currents lower than the rated current. The correction factor,  $K_p$ , is given as a function of the RMS load current,  $I_b$ , in percent of the rated current.

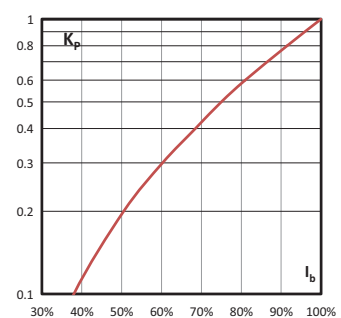

# Square body fuse links

## 170M - Sizes 1\* to 3, US style, 1000 V a.c. (IEC), 50 A to 1400 A

### Time-current curve - Size 3, 315 A to 1400 A

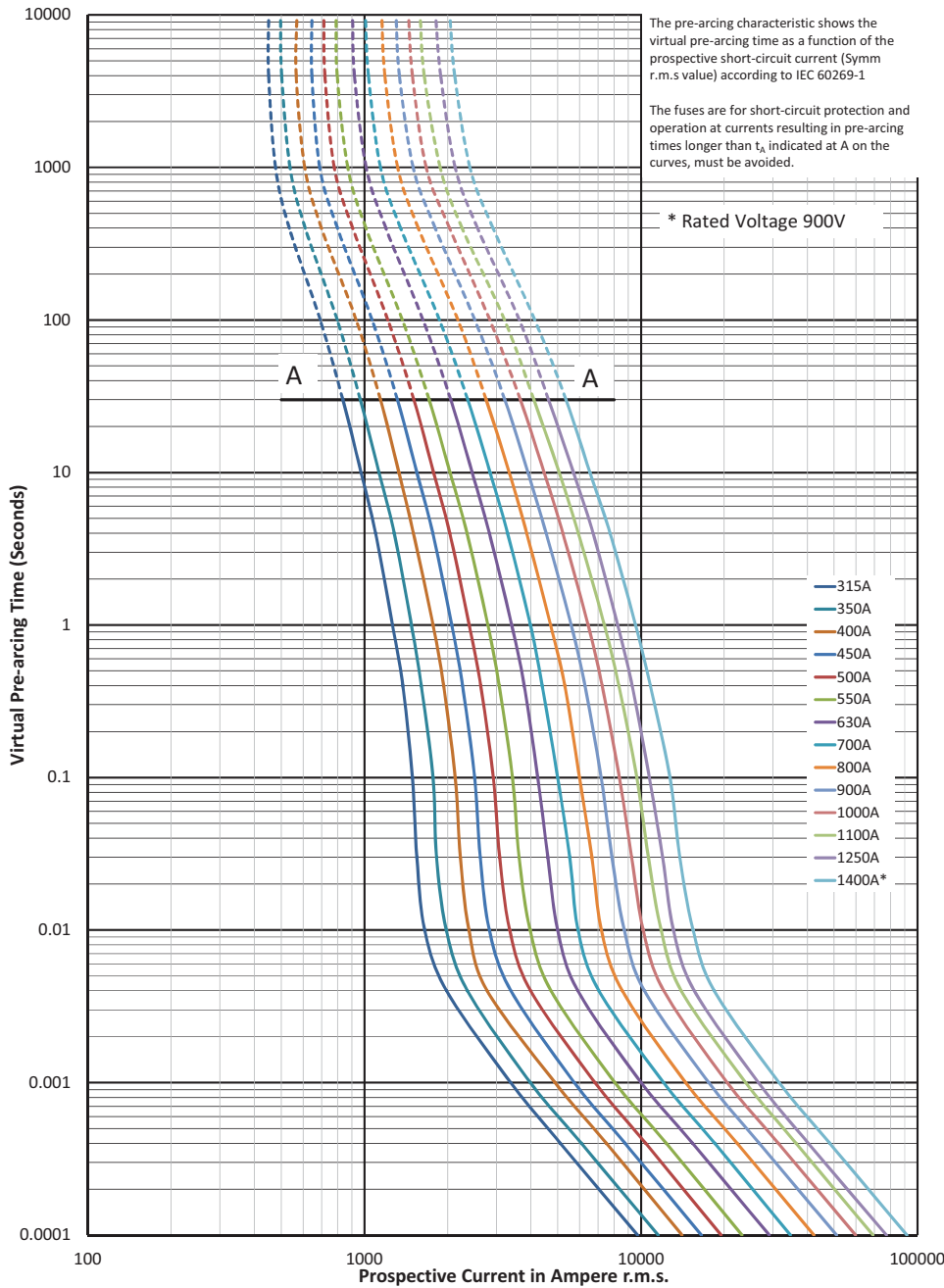

**170M - Sizes 1\* to 3, US style, 1000 V a.c. (IEC), 50 A to 1400 A**

**Cut-off curve - Size 3, 315 A to 1400 A**

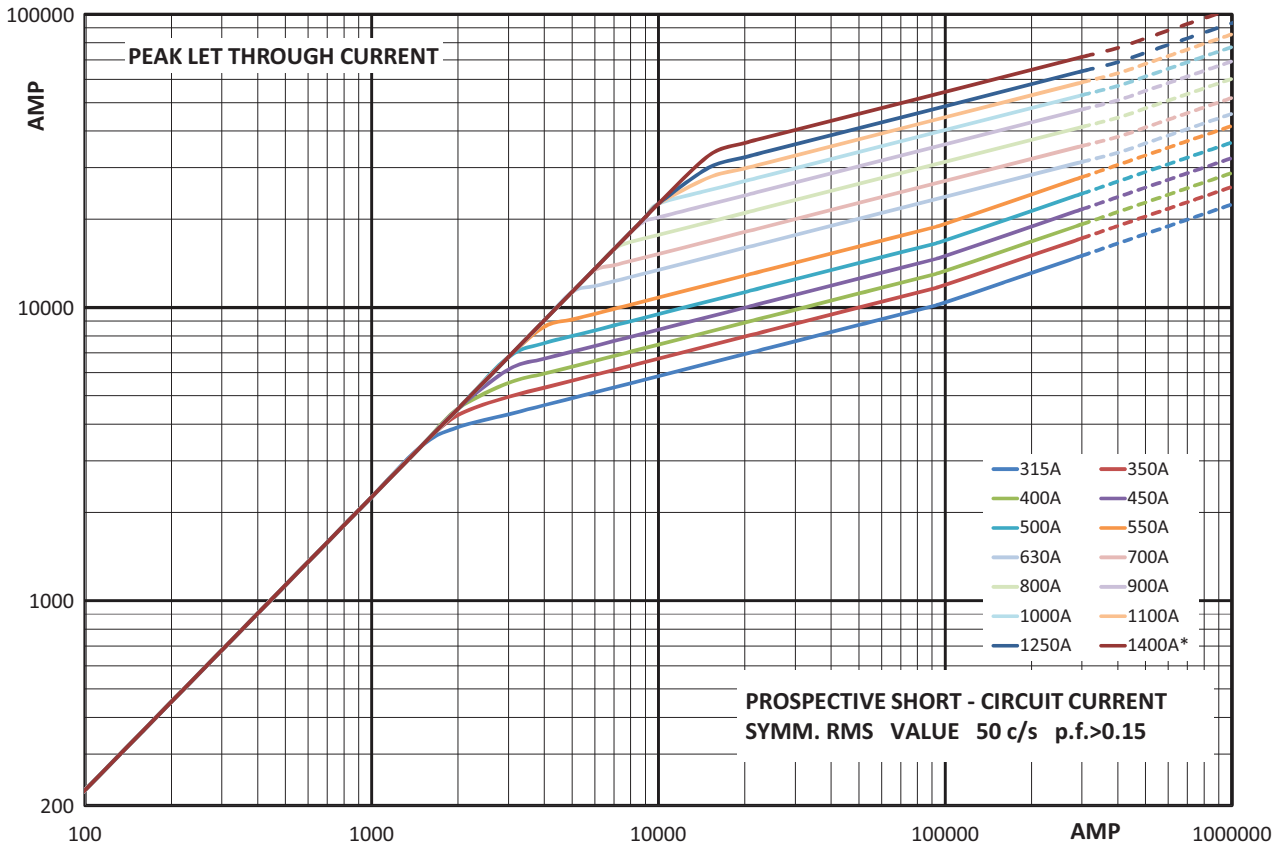

**Total clearing I<sup>2</sup>t**

The total clearing I<sup>2</sup>t at rated voltage and at a power factor of 15 percent are given in the electrical characteristics. For other voltages, the clearing I<sup>2</sup>t is found by multiplying by correction factor, K, given as a function of applied working voltage, E<sub>g</sub>, (RMS).

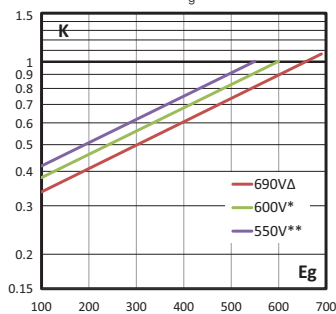

**Arc voltage**

This curve gives the peak arc voltage, U<sub>L</sub>, which may appear across the fuse during its operation as a function of the applied working voltage, E<sub>g</sub>, (RMS) at a power factor of 15 percent.

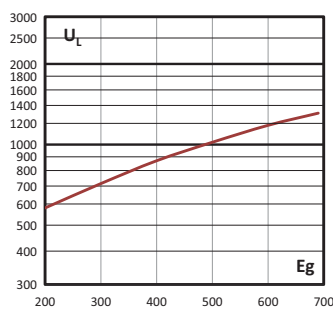

**Watts losses**

Watts loss at rated current is given in the electrical characteristics. The curve allows the calculation of the watts losses at load currents lower than the rated current. The correction factor, K<sub>p</sub>, is given as a function of the RMS load current, I<sub>b</sub>, in percent of the rated current.

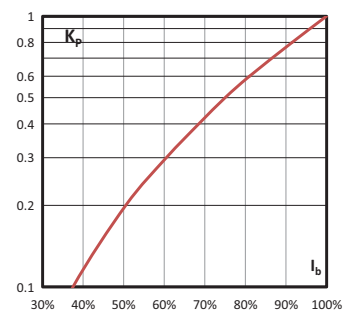

# Square body fuse links

**170M** - Sizes 1\* to 3, US style, 1250 V a.c. (IEC), 1300 V a.c. (UL), 50 A to 1400 A

## Specifications

### Description

Square body US style bolted tags high speed fuse links for the protection of DC common bus, DC drives, power converters/rectifiers and reduced rated voltage starters.

### Technical data

- Rated voltage: 1250 V a.c. (IEC), 1300 V a.c. (UL)
- Rated current: 50 A to 1400 A
- Breaking capacity:
  - 100 kA RMS Sym.A.C.
  - Size 1\* 90 kA D.C.
- -Operating class: aR

### Standards / Agency information

CE, Designed and tested to IEC 60269 part 4. Consult Eaton for UL Recognition/CSA Component Acceptance status and CCC approvals



### Dimensions (mm)

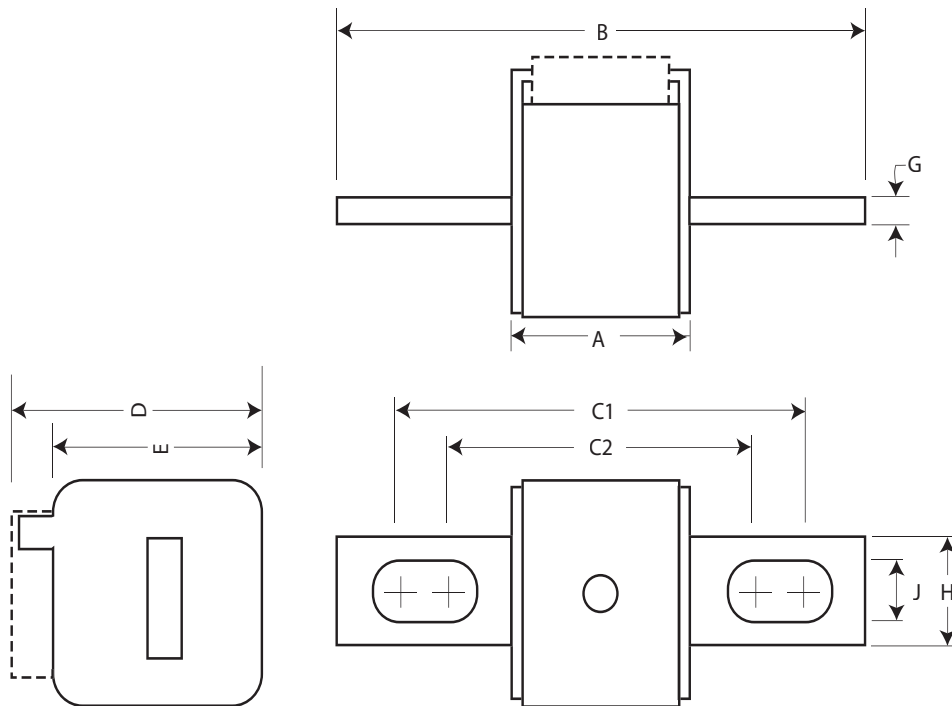

Size	A	B	C1	C2	D	E	G	H	J
1*	74	156	130	101	59	45	6	20	10
1	76	160	127	102	69	53	6	25	14
2	76	160	127	102	77	61	6	25	14
3	76	159	128	101	92	76	6	36	16

Data sheets: 170K6630 (Size 1\*), 170K6632 (Size 1), 170K6634 (Size 2), 170K6636 (Size 3)



**170M - Sizes 1\* to 3, US style, 1250 V a.c. (IEC), 1300 V a.c. (UL), 50 A to 1400 A**

**Catalogue numbers**

Fuse link body size	Rated voltage	Rated current (Amps)	I <sup>2</sup> t (A <sup>2</sup> Sec)			Watts loss (W)	Catalogue numbers		
			Pre-arcing	Clearing at 1000 V a.c.	Clearing at 1250 V a.c.		-FU/115 without indicator	-FKE/115 Type K indicator for micro	
1*	1250 V a.c. (IEC) 1300 V a.c. (UL)	50	135	815	1100	15	170M3688 <sup>1</sup>	170M3738 <sup>1</sup>	
		63	215	1300	1750	20	170M3689 <sup>1</sup>	170M3739 <sup>1</sup>	
		80	420	2500	3350	25	170M3690 <sup>1</sup>	170M3740 <sup>1</sup>	
		100	750	4450	5950	30	170M3691 <sup>1</sup>	170M3741 <sup>1</sup>	
		125	1450	9000	11,500	35	170M3692 <sup>1</sup>	170M3742 <sup>1</sup>	
		160	2600	16,000	21,000	40	170M3693 <sup>1</sup>	170M3743 <sup>1</sup>	
		200	5150	31,000	41,000	45	170M3694 <sup>1</sup>	170M3744 <sup>1</sup>	
		250	9200	54,500	73,000	55	170M3695 <sup>1</sup>	170M3745 <sup>1</sup>	
		315	18,500	115,000	150,000	60	170M3696 <sup>1</sup>	170M3746 <sup>1</sup>	
1	1250 V a.c. (IEC) 1300 V a.c. (UL)	350	27,000	165,000	220,000	65	170M3697 <sup>1</sup>	170M3747 <sup>1</sup>	
		160	1900	11,500	15,500	45	170M4688	170M4738	
		200	3800	22,500	30,000	50	170M4689	170M4739	
		250	7750	46,000	61,500	60	170M4690	170M4740	
		315	15,000	90,000	120,000	65	170M4691	170M4741	
		350	20,000	125,000	165,000	70	170M4692	170M4742	
		400	29,500	175,000	235,000	75	170M4693	170M4743	
		450	42,000	250,000	335,000	80	170M4694	170M4744	
		500	69,500	340,000	N/A	85	170M4695	170M4745	
		550	95,000	465,000	N/A	95	170M4696	170M4746	
		1000 V a.c. IEC	630	130,000	660,000	N/A	100	170M4697	170M4747
2	1250 V a.c. (IEC) 1300 V a.c. (UL)	250	6500	38,500	51,500	65	170M5688	170M5738	
		280	9350	55,500	74,500	70	170M5689	170M5739	
		315	13,000	77,500	105,000	75	170M5690	170M5740	
		350	16,500	97,500	135,000	80	170M5691	170M5741	
		400	23,000	140,000	180,000	85	170M5692	170M5742	
		450	34,000	205,000	270,000	90	170M5693	170M5743	
		500	48,000	285,000	380,000	95	170M5694	170M5744	
		550	62,000	370,000	495,000	100	170M5695	170M5745	
		630	115,000	575,000	730,000	120	170M5696	170M5746	
		700	160,000	795,000	N/A	125	170M5697	170M5747	
		800	245,000	1,200,000	N/A	130	170M5698	170M5748	
		900	360,000	1,750,000	N/A	135	170M5699	170M5749	
		1000 V a.c. IEC	1000	480,000	2,350,000	N/A	145	170M5700	170M5750
		3	1250 V a.c. (IEC) 1300 V a.c. (UL)	315	9500	58,000	77,500	85	170M6688
350	13,500			81,500	110,000	90	170M6689	170M6739	
400	19,500			120,000	160,000	95	170M6690	170M6740	
450	31,000			185,000	245,000	100	170M6691	170M6741	
500	39,000			235,000	310,000	105	170M6692	170M6742	
550	55,000			325,000	435,000	110	170M6693	170M6743	
630	83,500			495,000	665,000	115	170M6694	170M6744	
700	115,000			705,000	940,000	120	170M6695	170M6745	
800	205,000			995,000	1,300,000	125	170M6696	170M6746	
900	305,000			1,500,000	1,900,000	130	170M6697	170M6747	
1000 V a.c. (IEC)	1000			450,000	2,150,000	N/A	135	170M6698	170M6748
1000 V a.c. (UL)	1100			575,000	2,800,000	N/A	160	170M6699	170M6749
1000 V a.c. IEC & UL	1250			810,000	3,950,000	N/A	170	170M6700	170M6750
	1400			1,250,000	6,000,000	N/A	175	170M6701	170M6751

<sup>1</sup> Rated at 900 V d.c. 8XIn 90 kA

# Square body fuse links

## 170M - Sizes 1\* to 3, US style, 1250 V a.c. (IEC), 1300 V a.c. (UL), 50 A to 1400 A

### Time-current curve - Size 1\*, 50 A to 350 A

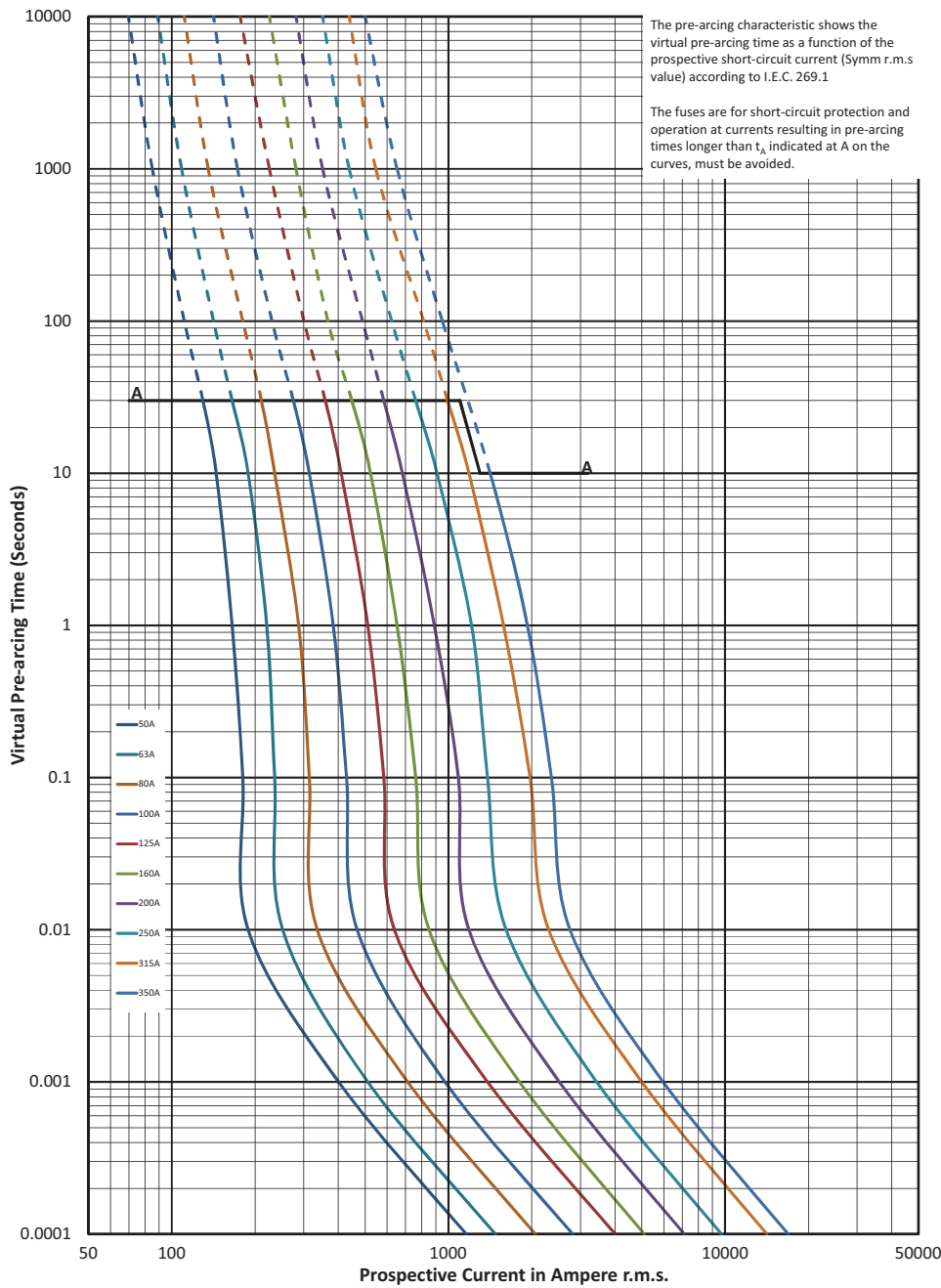

**170M - Sizes 1\* to 3, US style, 1250 V a.c. (IEC), 1300 V a.c. (UL), 50 A to 1400 A**

**Cut-off curve - Size 1\*, 50 A to 350 A**

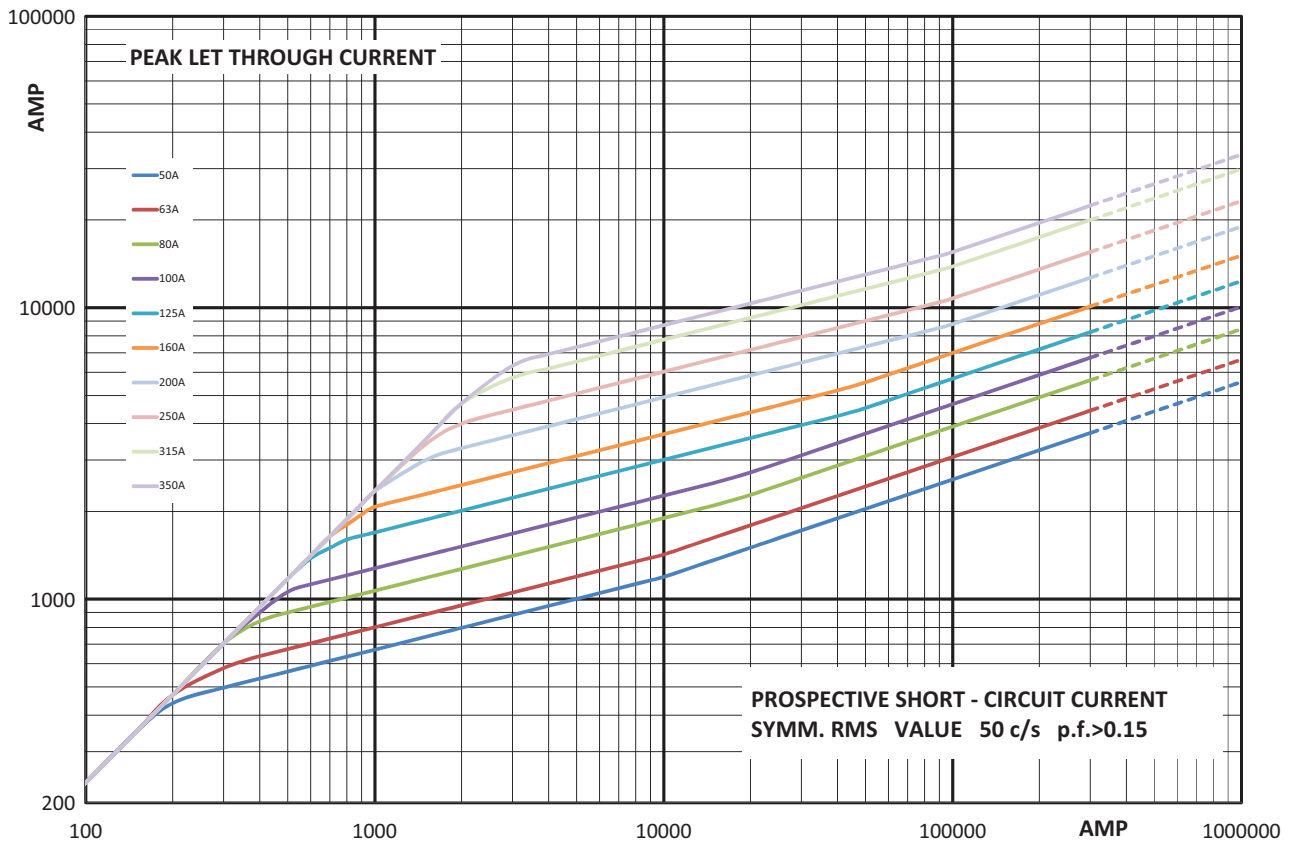

**Total clearing  $I^2t$**

The total clearing  $I^2t$  at rated voltage and at a power factor of 15 percent are given in the electrical characteristics. For other voltages, the clearing  $I^2t$  is found by multiplying by correction factor,  $K$ , given as a function of applied working voltage,  $E_g$ , (RMS).

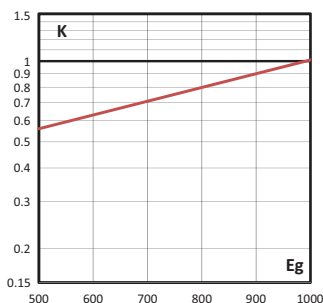

**Arc voltage**

This curve gives the peak arc voltage,  $U_L$ , which may appear across the fuse during its operation as a function of the applied working voltage,  $E_g$ , (RMS) at a power factor of 15 percent.

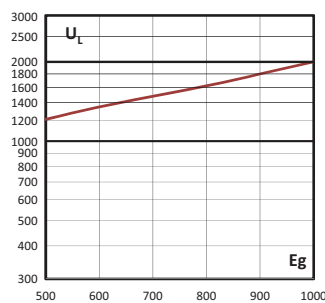

**Watts losses**

Watts loss at rated current is given in the electrical characteristics. The curve allows the calculation of the watts losses at load currents lower than the rated current. The correction factor,  $K_p$ , is given as a function of the RMS load current,  $I_b$ , in percent of the rated current.

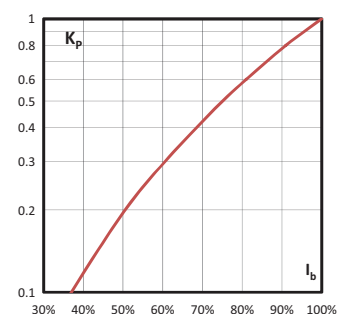

Data sheets: 170K6630 (Size 1\*), 170K6632 (Size 1), 170K6634 (Size 2), 170K6636 (Size 3)

# Square body fuse links

## 170M - Sizes 1\* to 3, US style, 1250 V a.c. (IEC), 1300 V a.c. (UL), 50 A to 1400 A

### Time-current curve - Size 1, 160 A to 630 A

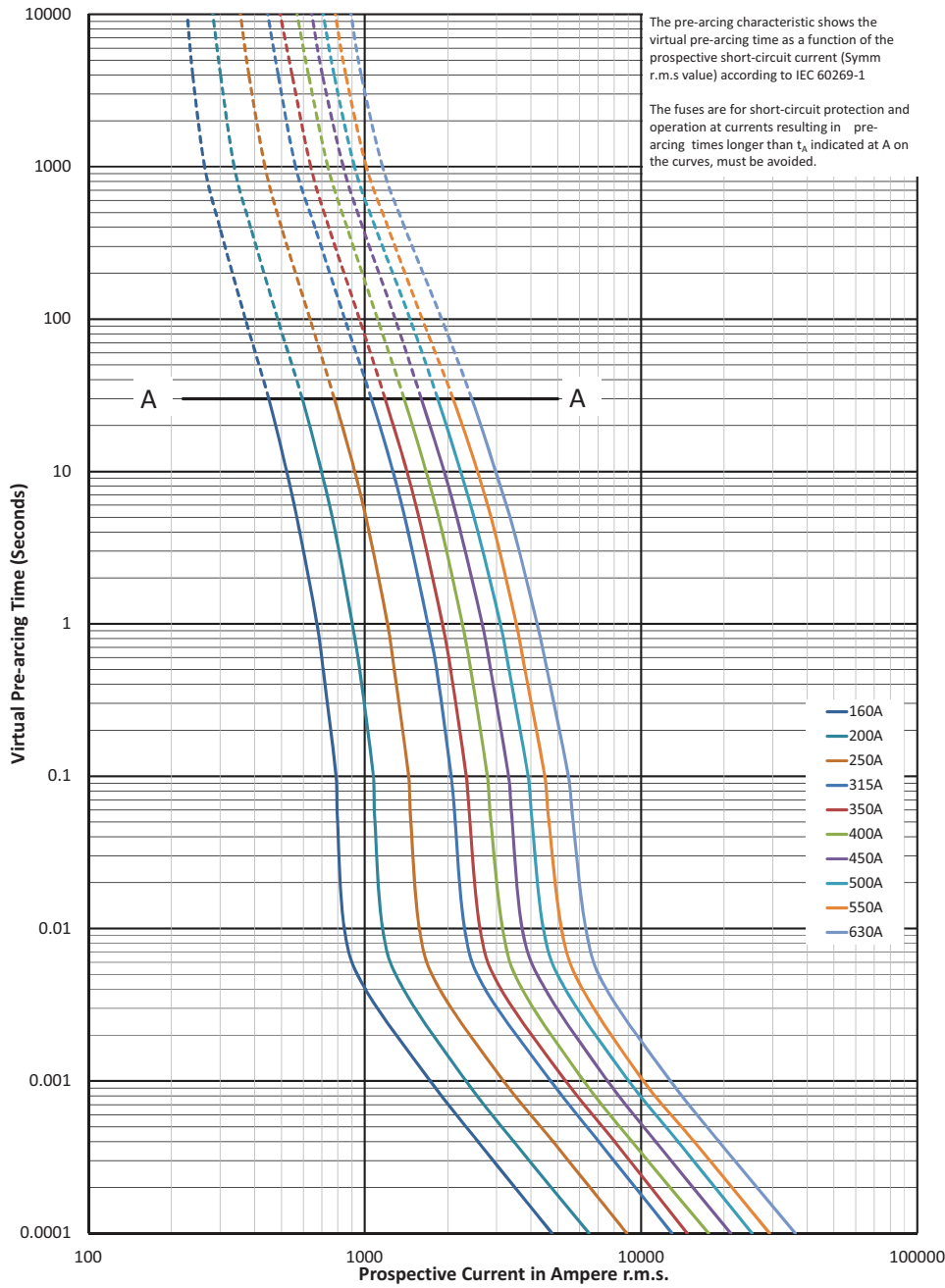

Data sheets: 170K6630 (Size 1\*), 170K6632 (Size 1), 170K6634 (Size 2), 170K6636 (Size 3)

**170M - Sizes 1\* to 3, US style, 1250 V a.c. (IEC), 1300 V a.c. (UL), 50 A to 1400 A**

**Cut-off curve - Size 1, 160 A to 630 A**

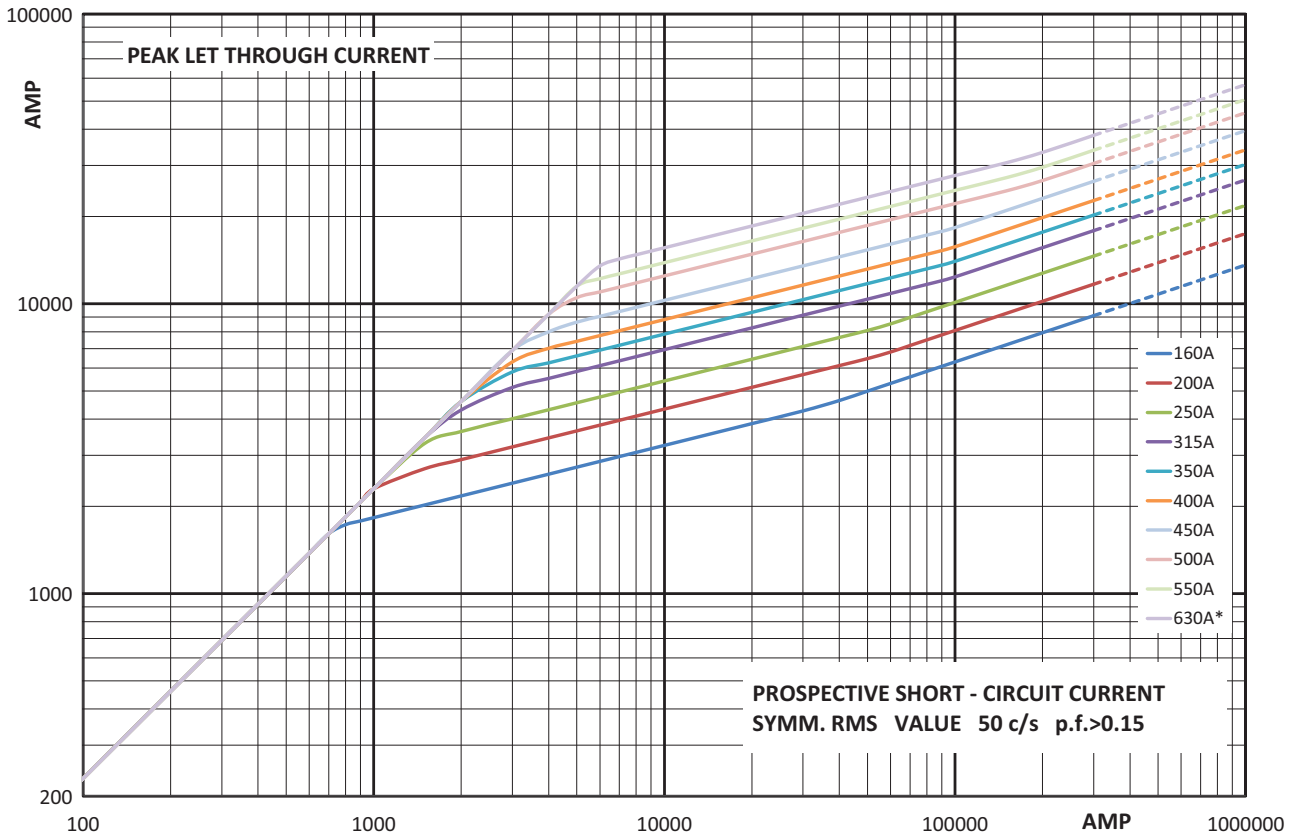

**Total clearing I<sup>2</sup>t**

The total clearing I<sup>2</sup>t at rated voltage and at a power factor of 15 percent are given in the electrical characteristics. For other voltages, the clearing I<sup>2</sup>t is found by multiplying by correction factor, K, given as a function of applied working voltage, E<sub>g</sub>, (RMS).

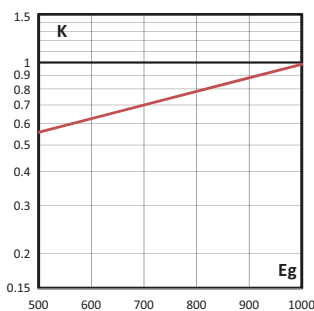

**Arc voltage**

This curve gives the peak arc voltage, U<sub>L</sub>, which may appear across the fuse during its operation as a function of the applied working voltage, E<sub>g</sub>, (RMS) at a power factor of 15 percent.

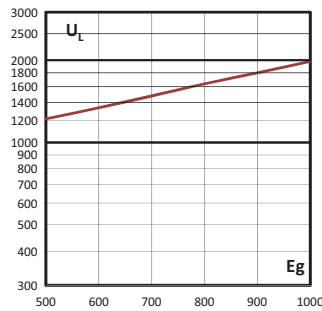

**Watts losses**

Watts loss at rated current is given in the electrical characteristics. The curve allows the calculation of the watts losses at load currents lower than the rated current. The correction factor, K<sub>p</sub>, is given as a function of the RMS load current, I<sub>b</sub>, in percent of the rated current.

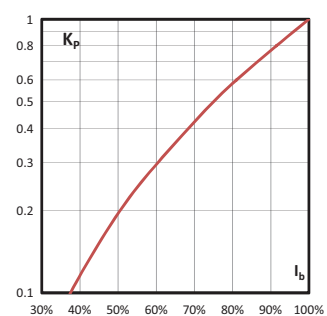

# Square body fuse links

## 170M - Sizes 1\* to 3, US style, 1250 V a.c. (IEC), 1300 V a.c. (UL), 50 A to 1400 A

### Time-current curve - Size 2, 250 A to 1000 A

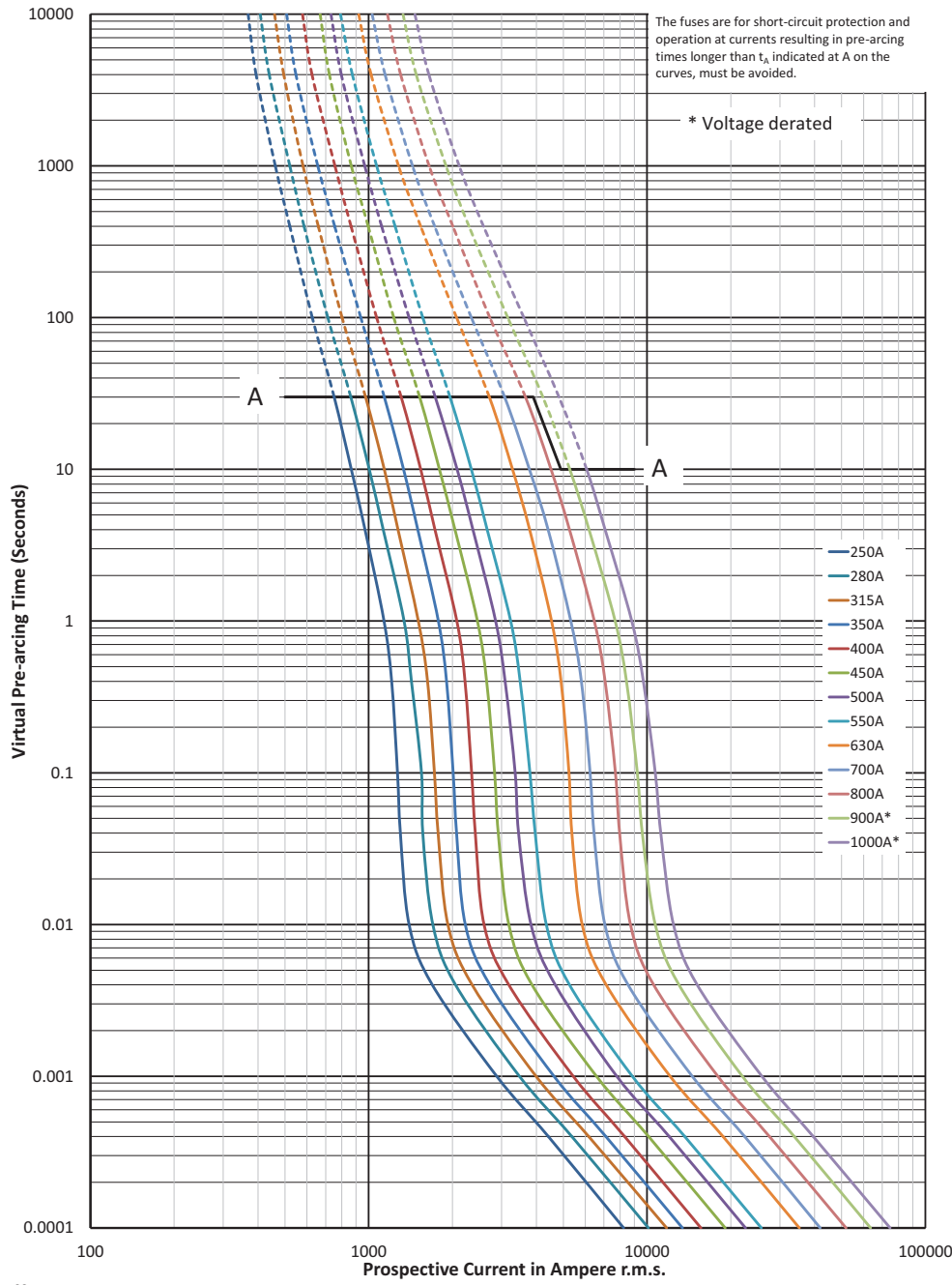

$K_b = 1$     $N = 1.6$

**170M - Sizes 1\* to 3, US style, 1250 V a.c. (IEC), 1300 V a.c. (UL), 50 A to 1400 A**

**Cut-off curve - Size 2, 250 A to 1000 A**

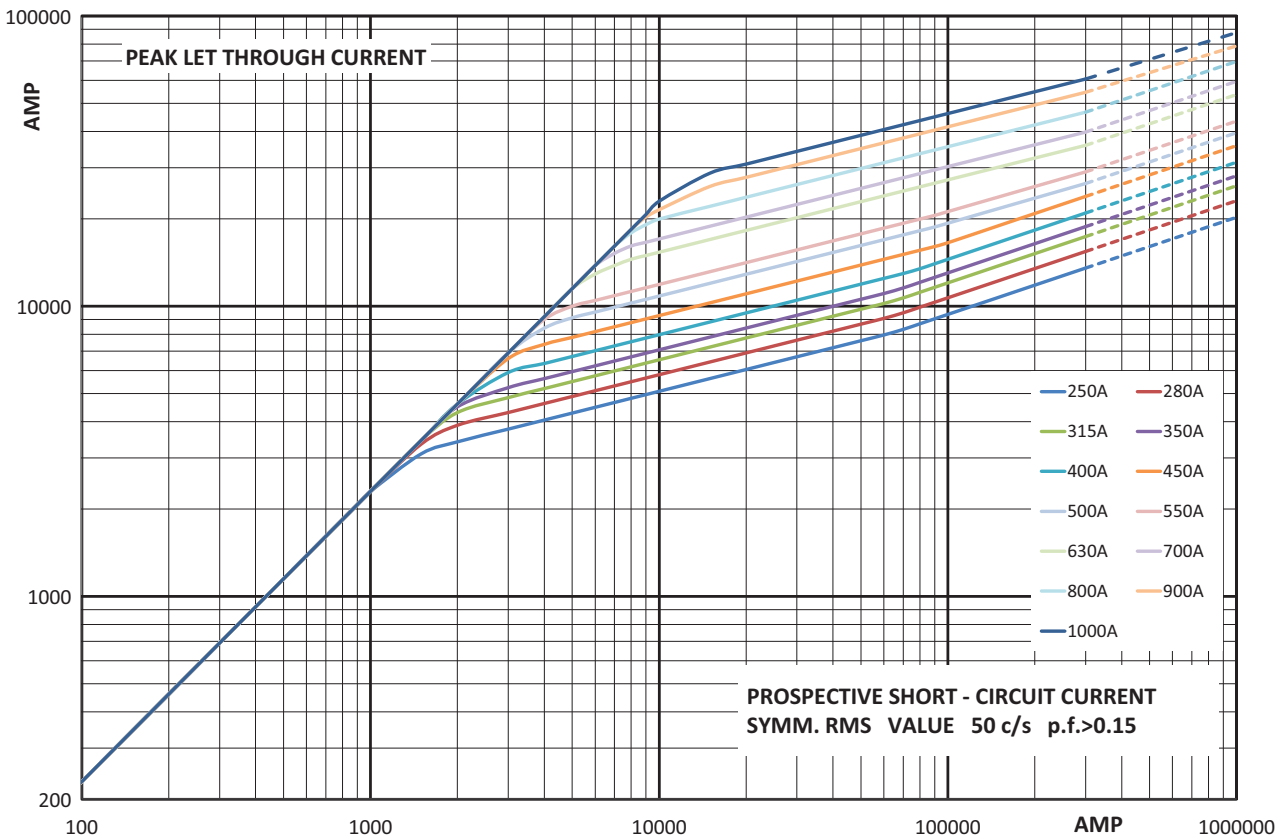

**Total clearing I<sup>2</sup>t**

The total clearing I<sup>2</sup>t at rated voltage and at a power factor of 15 percent are given in the electrical characteristics. For other voltages, the clearing I<sup>2</sup>t is found by multiplying by correction factor, K, given as a function of applied working voltage, E<sub>g</sub>, (RMS).

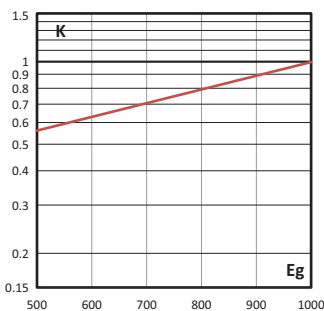

**Arc voltage**

This curve gives the peak arc voltage, U<sub>L</sub>, which may appear across the fuse during its operation as a function of the applied working voltage, E<sub>g</sub>, (RMS) at a power factor of 15 percent.

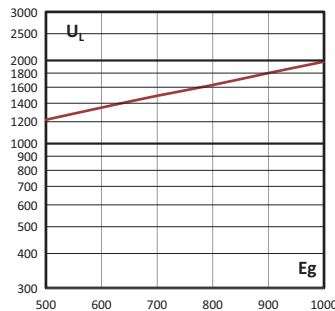

**Watts losses**

Watts loss at rated current is given in the electrical characteristics. The curve allows the calculation of the watts losses at load currents lower than the rated current. The correction factor, K<sub>p</sub>, is given as a function of the RMS load current, I<sub>b</sub>, in percent of the rated current.

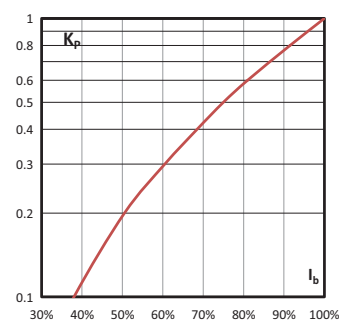

# Square body fuse links

## 170M - Sizes 1\* to 3, US style, 1250 V a.c. (IEC), 1300 V a.c. (UL), 50 A to 1400 A

### Time-current curve - Size 3, 315 A to 1400 A

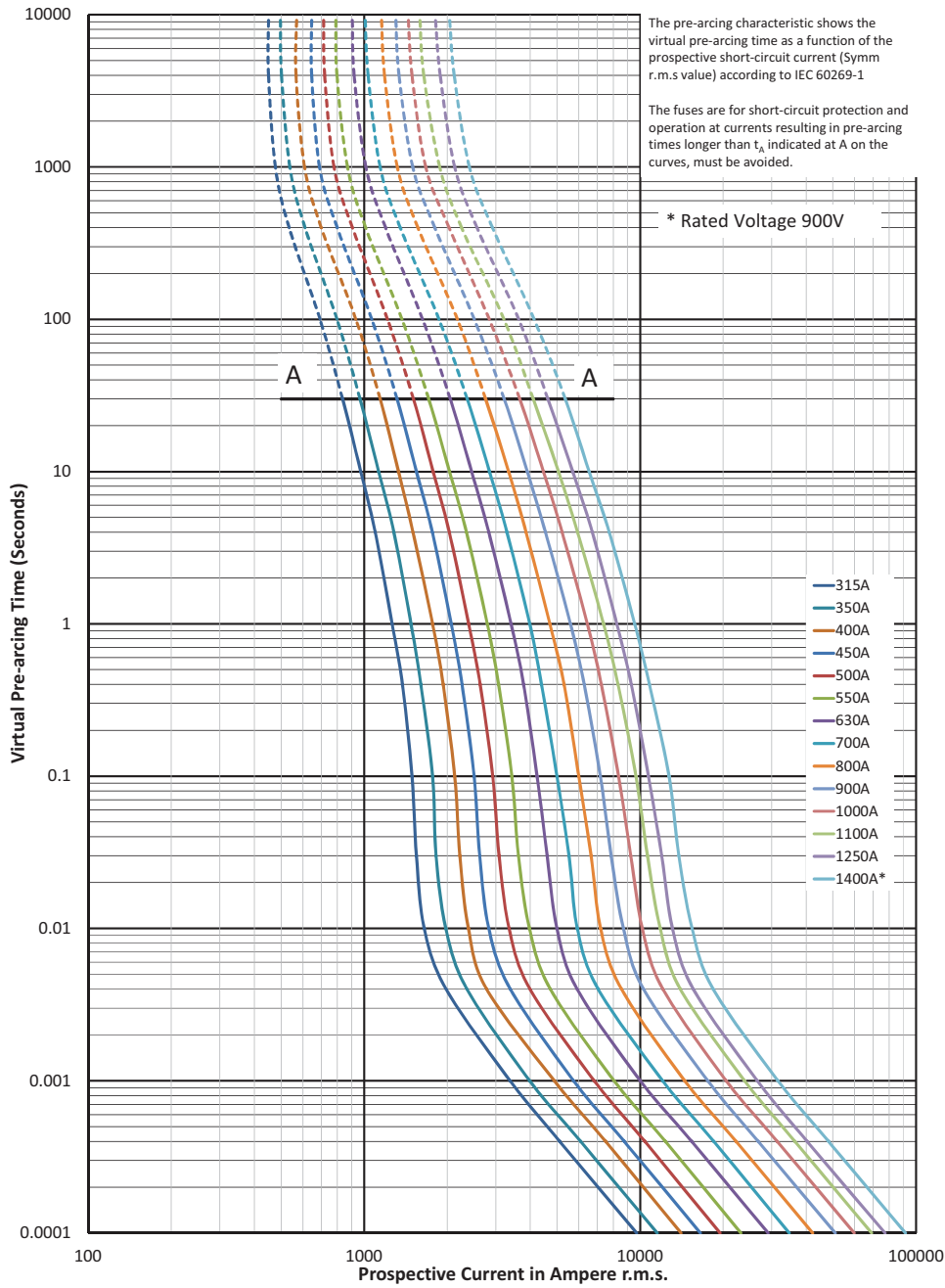



**170M - Sizes 1\* to 3, US style, 1250 V a.c. (IEC), 1300 V a.c. (UL), 50 A to 1400 A**

**Cut-off curve - Size 3, 315 A to 1400 A**

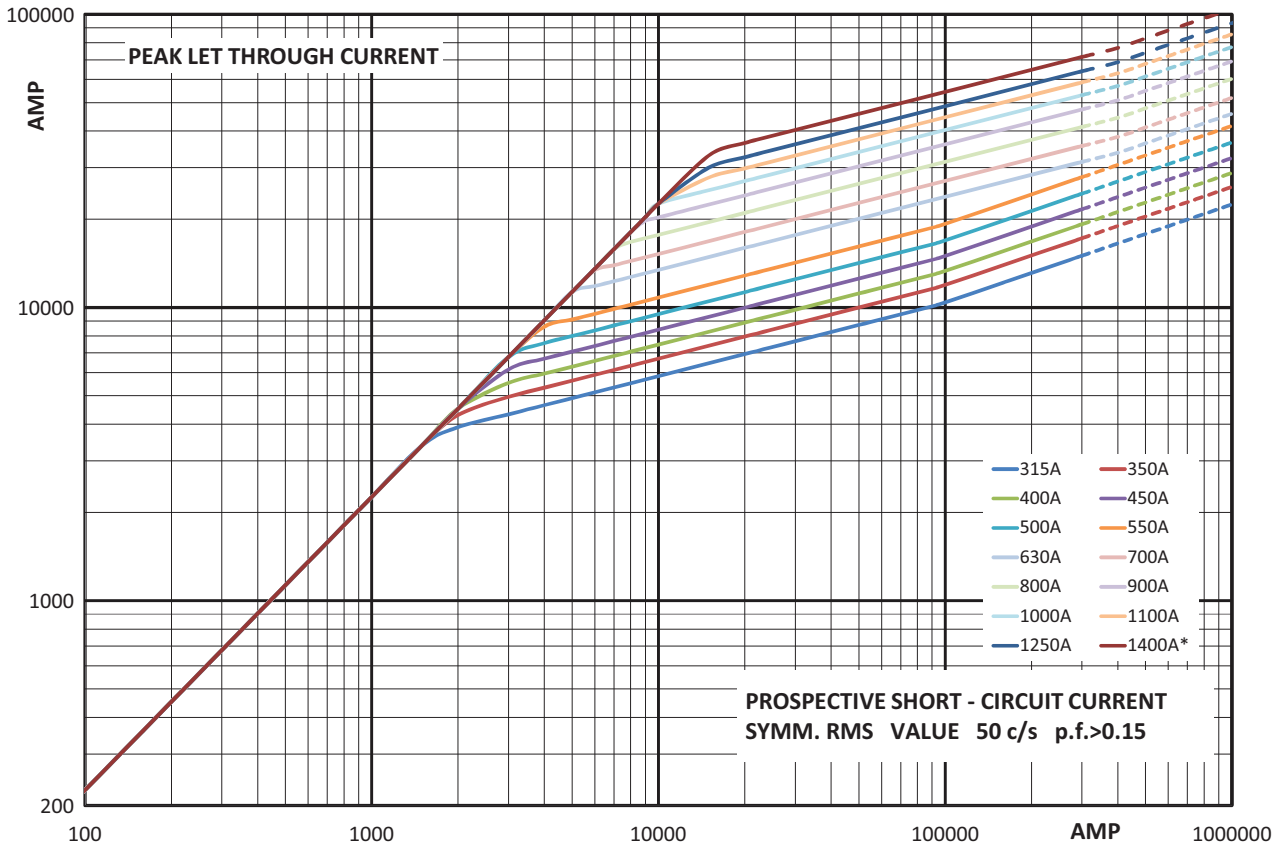

**Total clearing  $I^2t$**

The total clearing  $I^2t$  at rated voltage and at a power factor of 15 percent are given in the electrical characteristics. For other voltages, the clearing  $I^2t$  is found by multiplying by correction factor,  $K$ , given as a function of applied working voltage,  $E_g$ , (RMS).

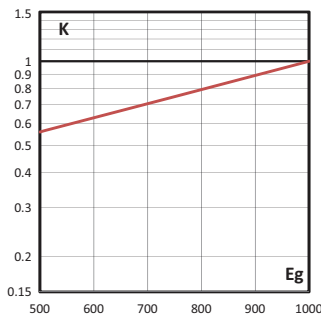

**Arc voltage**

This curve gives the peak arc voltage,  $U_L$ , which may appear across the fuse during its operation as a function of the applied working voltage,  $E_g$ , (RMS) at a power factor of 15 percent.

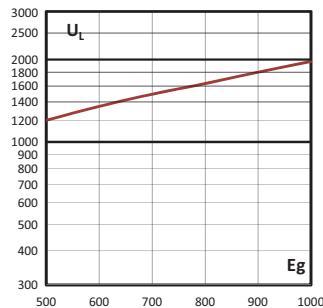

**Watts losses**

Watts loss at rated current is given in the electrical characteristics. The curve allows the calculation of the watts losses at load currents lower than the rated current. The correction factor,  $K_p$ , is given as a function of the RMS load current,  $I_b$ , in percent of the rated current.

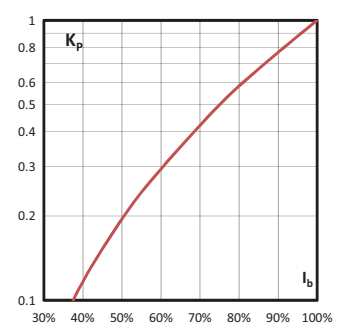

# Square body fuse links

## 170M - Size 00, Flush end contact, 690 V a.c., 25 A to 400 A

### Specifications

#### Description

Square body flush end contact high speed fuse links, for the protection of DC common bus, DC drives, power converters/rectifiers and reduced rated voltage starters.

#### Technical data

- Rated voltage: 690 V a.c. (IEC)
- Rated current: 25 A to 400 A
- Breaking capacity: 200 kA RMS Sym
- Operating class:
  - gR (25 A to 80 A)
  - aR (100 A to 400 A)



#### Standards / Agency information

CE, Designed and tested to IEC 60269 Part 4

#### Catalogue numbers

Fuse link body size	Rated voltage	Rated current (Amps)	I <sup>2</sup> t (A <sup>2</sup> Sec)		Watts loss (W)	Catalogue numbers	
			Pre-arcing	Clearing at 660 V a.c.		00B/60 visual indicator	00BTN/60 Type T indicator for micro
00	690 V a.c. (IEC)	25	19	130	6	170M2708	170M2758
		32	28.5	195	7	170M2709	170M2759
		40	50	360	9	170M2710	170M2760
		50	95	640	10	170M2711	170M2761
		63	170	1200	12	170M2712	170M2762
		80	310	2100	15	170M2713	170M2763
		100	620	4150	20	170M2714	170M2764
		125	1000	6950	25	170M2715	170M2765
		160	1900	13,000	30	170M2716	170M2766
		200	3400	23,000	35	170M2717	170M2767
		250	6250	42,000	45	170M2718	170M2768
		315	10,000	68,500	55	170M2719	170M2769
		350	13,500	91,500	60	170M2720	170M2770
		400	18,000	125,000	70	170M2721	170M2771

#### Dimensions (mm)

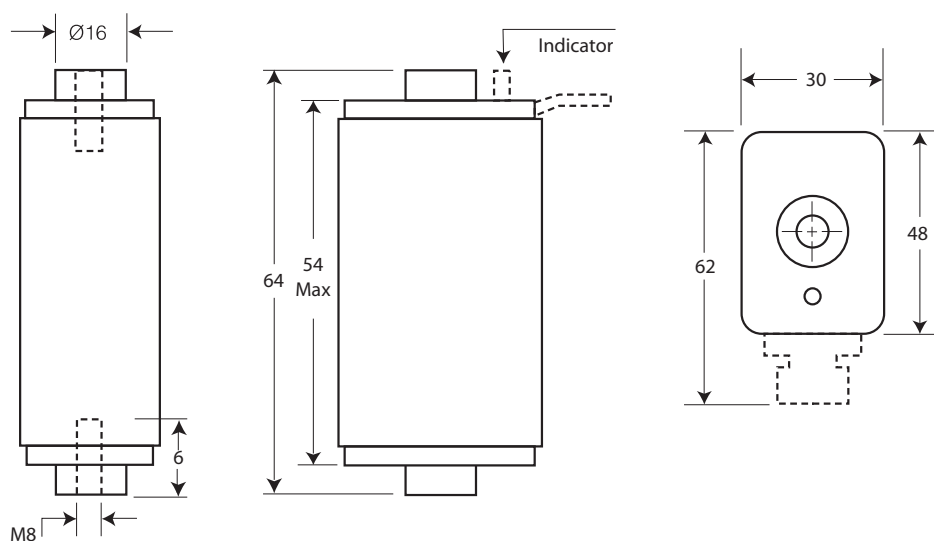

**170M - Size 00, Flush end contact, 690 V a.c., 25 A to 400 A**

Time-current curve - Size 00, 25 A to 400 A

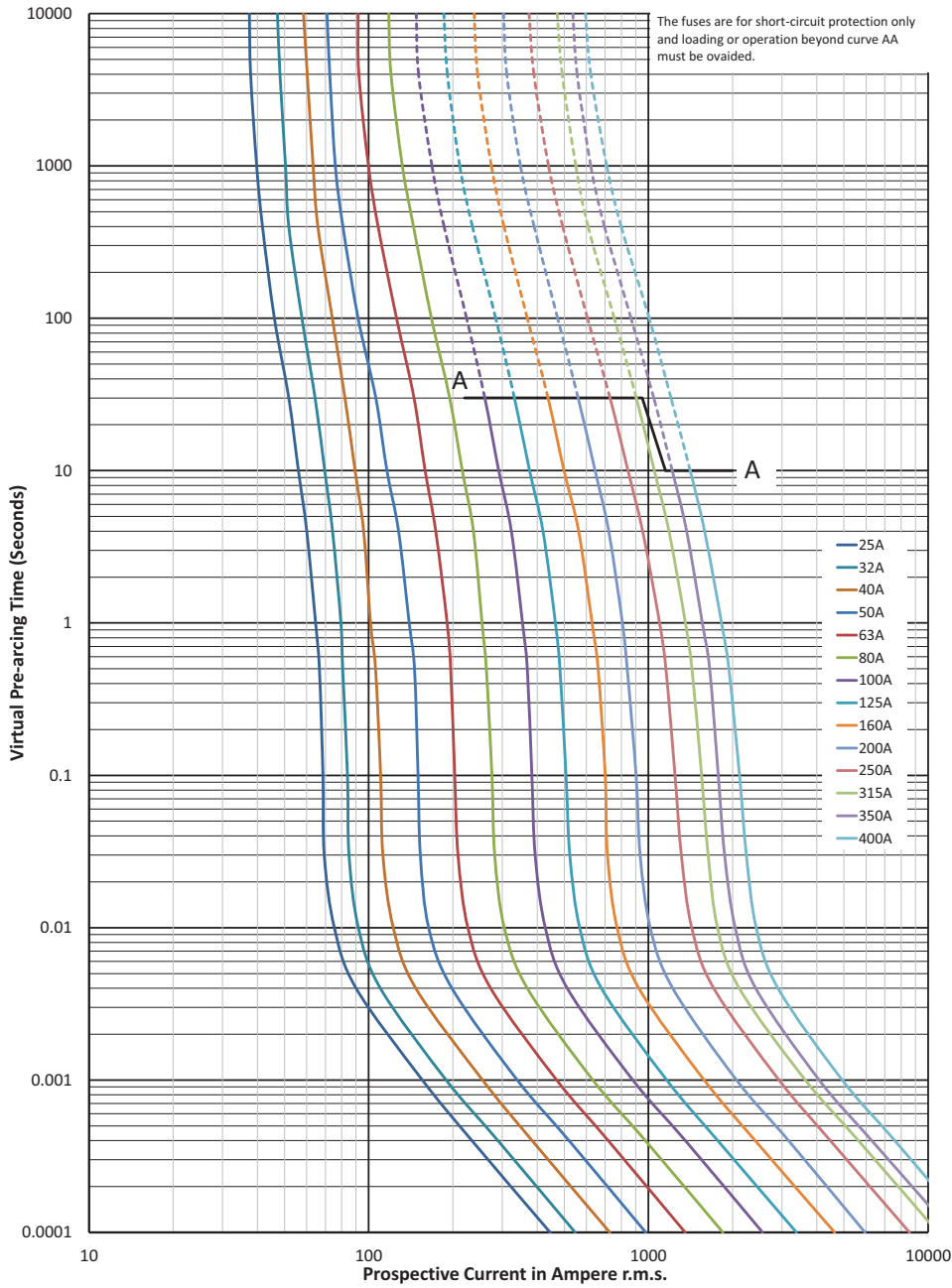

$K_b = 1$     $N = 1.5$

# Square body fuse links

## 170M - Size 00, Flush end contact, 690 V a.c., 25 A to 400 A

### Cut-off curve - Size 00, 25 A to 400 A

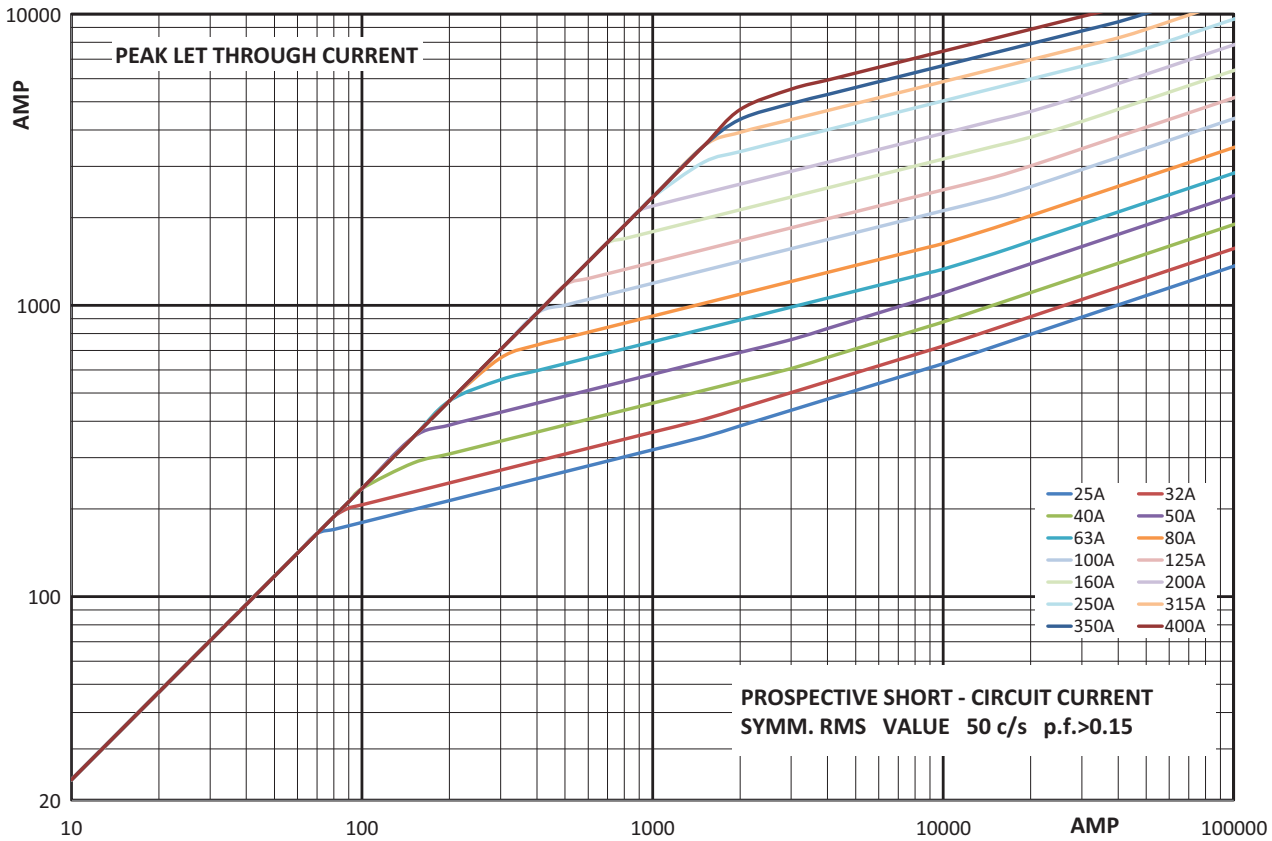

### Total clearing $I^2t$

The total clearing  $I^2t$  at rated voltage and at a power factor of 15 percent are given in the electrical characteristics. For other voltages, the clearing  $I^2t$  is found by multiplying by correction factor,  $K$ , given as a function of applied working voltage,  $E_g$ , (RMS).

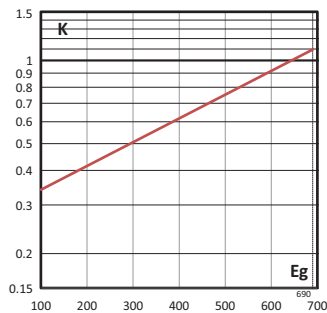

### Arc voltage

This curve gives the peak arc voltage,  $U_L$ , which may appear across the fuse during its operation as a function of the applied working voltage,  $E_g$ , (RMS) at a power factor of 15 percent.

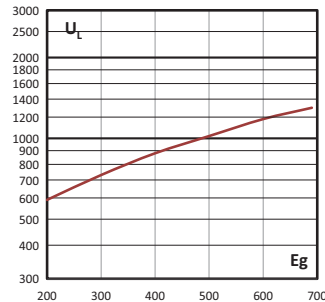

### Watts losses

Watts loss at rated current is given in the electrical characteristics. The curve allows the calculation of the watts losses at load currents lower than the rated current. The correction factor,  $K_p$ , is given as a function of the RMS load current,  $I_b$ , in percent of the rated current.

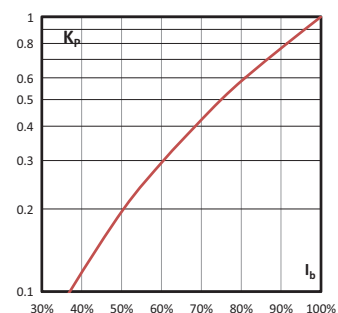

## 170M - Sizes 1\* to 3, Flush end contact, 690 V a.c. (IEC), 700 V a.c. (UL), 40 A to 2000 A

### Specifications

#### Description

Square body flush end contact high speed fuse links, for the protection of DC common bus, DC drives, power converters/rectifiers and reduced rated voltage starters.

#### Technical data

- Rated voltage: see table page 192
- Rated current: 40 A to 2000 A
- Breaking capacity: 200 kA RMS Sym
- Operating class: aR

#### Standards / Agency information

CE, Designed and tested to IEC 60269 Part 4. Consult Eaton for UL Recognition, CSA Component Acceptance Status and CCC approvals

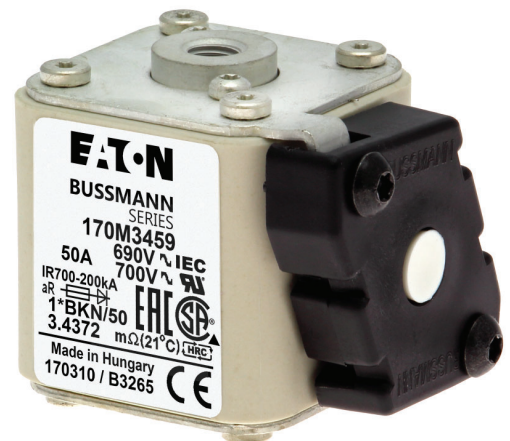

#### Dimensions (mm)

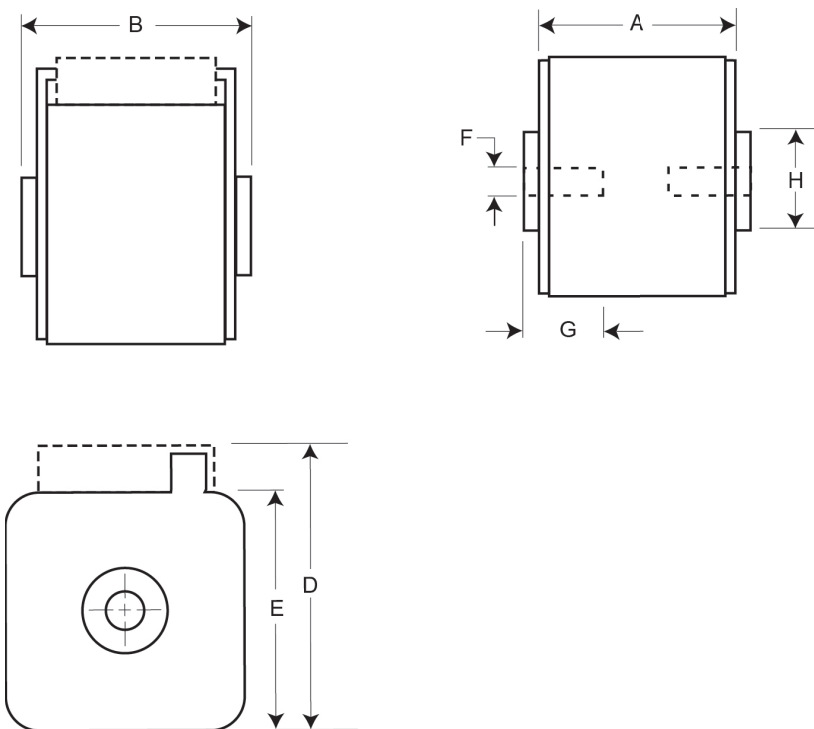

Size	A	B	D <sup>3</sup>	E	F	F <sup>1</sup> (in)	G min	H
1*	50	51	59	45	M8	5/16" -18 UNC-2B	5	N17
1	50	51	69	53	M8	5/16" -18 UNC-2B	8	N20
2	50	51 (400 - 1000 A) 65 (1100 and 1250 (A))	77	61	M10	3/8" -16 UNC-2B	10	N24
3	51	53 (500 - 1500 A) 65 (1600 - 2000 A)	92	76	M12	1/2" -13 UNC-2B	10	N30

<sup>1</sup> Valid for fuse links type -G- & -GKN/.

<sup>3</sup> Valid for fuse links type -BKN/ and -GKN/.

Data sheets: 170K6314 (Size 1\*), 170K6316 (Size 1), 170K6318 (Size 2), 170K6320 (Size 3)

# Square body fuse links

## 170M - Sizes 1\* to 3, Flush end contact, 690 V a.c. (IEC), 700 V a.c. (UL), 40 A to 2000 A

Fuse link body size	Rated voltage	I <sup>2</sup> t (A <sup>2</sup> Sec)				Catalogue numbers				
		Rated current (Amps)	Pre-arcing	Clearing at 660 V a.c.	Watts loss (W)	-B/- visual indicator	-BKN/- Type K indicator for micro	-G/- visual indicator	-GKN/- Type K indicator for micro	
1*	690 V a.c. (IEC) 700 V a.c. (UL)	40	40	270	11	170M3408	170M3458	170M3508	170M3558	
		50	77	515	13	170M3409	170M3459	170M3509	170M3559	
		63	115	770	17	170M3410	170M3460	170M3510	170M3560	
		80	185	1250	21	170M3411	170M3461	170M3511	170M3561	
		100	360	2450	24	170M3412	170M3462	170M3512	170M3562	
		125	550	3700	30	170M3413	170M3463	170M3513	170M3563	
		160	1100	7500	34	170M3414	170M3464	170M3514	170M3564	
		200	2200	15,000	41	170M3415	170M3465	170M3515	170M3565	
		250	4200	28,500	47	170M3416	170M3466	170M3516	170M3566	
		315	7000	46,500	60	170M3417	170M3467	170M3517	170M3567	
		350	10,000	68,500	64	170M3418	170M3468	170M3518	170M3568	
		400	15,000	105,000	69	170M3419	170M3469	170M3519	170M3569	
		450	21,000	140,000	75	170M3420	170M3470	170M3520	170M3570	
		500	27,000	180,000	83	170M3421	170M3471	170M3521	170M3571	
		550	34,000	230,000	89	170M3422	170M3472	170M3522	170M3572	
630	48,500	325,000	100	170M3423	170M3473	170M3523	170M3573			
1	690 V a.c. (IEC) 700 V a.c. (UL)	200	1650	11,500	45	170M4408	170M4458	170M4508	170M4558	
		250	3100	21,000	55	170M4409	170M4459	170M4509	170M4559	
		315	6200	42,000	58	170M4410	170M4460	170M4510	170M4560	
		350	8500	59,000	60	170M4411	170M4461	170M4511	170M4561	
		400	13,500	91,500	65	170M4412	170M4462	170M4512	170M4562	
		450	17,000	120,000	70	170M4413	170M4463	170M4513	170M4563	
		500	25,000	170,000	72	170M4414	170M4464	170M4514	170M4564	
		550	34,000	230,000	75	170M4415	170M4465	170M4515	170M4565	
		630	52,000	350,000	80	170M4416	170M4466	170M4516	170M4566	
		700	69,500	465,000	85	170M4417	170M4467	170M4517	170M4567	
2	690 V a.c. (IEC) 700 V a.c. (UL)	800	105,000	725,000	95	170M4418	170M4468	170M4518	170M4568	
		900	155,000	850,000	100	170M4419	170M4469	170M4519	170M4569	
		400	11,000	74,000	65	170M5408	170M5458	170M5508	170M5558	
		450	15,500	105,000	70	170M5409	170M5459	170M5509	170M5559	
		500	21,500	145,000	75	170M5410	170M5460	170M5510	170M5560	
		550	28,000	190,000	80	170M5411	170M5461	170M5511	170M5561	
		630	41,000	275,000	90	170M5412	170M5462	170M5512	170M5562	
		700	60,500	405,000	95	170M5413	170M5463	170M5513	170M5563	
		800	86,000	575,000	105	170M5414	170M5464	170M5514	170M5564	
		900	125,000	840,000	110	170M5415	170M5465	170M5515	170M5565	
3	690 V a.c. (IEC) 700 V a.c. (UL)	1000	180,000	1,250,000	115	170M5416	170M5466	170M5516	170M5566	
		600 V a.c. (IEC) 700 V a.c. (UL)	1100	245,000	1,600,000	120	170M5417	170M5467	170M5517	170M5567
		1250	365,000	2,400,000	130	170M5418	170M5468	170M5518	170M5568	
		500	14,000	95,000	95	170M6408	170M6458	170M6508	170M6558	
		550	19,500	135,000	100	170M6409	170M6459	170M6509	170M6559	
		630	31,000	210,000	105	170M6410	170M6460	170M6510	170M6560	
		700	44,500	300,000	110	170M6411	170M6461	170M6511	170M6561	
		800	69,500	465,000	115	170M6412	170M6462	170M6512	170M6562	
		900	100,000	670,000	120	170M6413	170M6463	170M6513	170M6563	
		1000	140,000	945,000	125	170M6414	170M6464	170M6514	170M6564	
3	690 V a.c. (IEC) 700 V a.c. (UL)	1100	190,000	1,300,000	130	170M6415	170M6465 <sup>1</sup>	170M6515	170M6565	
		1250	290,000	1,950,000	140	170M6416	170M6466	170M6516	170M6566	
		1400	370,000	2,450,000	155	170M6417	170M6467 <sup>1</sup>	170M6517	170M6567	
		1500	460,000	3,100,000	160	170M6418	170M6468	170M6518	170M6568	
		1600	580,000	3,900,000	160	170M6419	170M6469	170M6519	170M6569	
		600 V a.c. (IEC) / 500 V a.c. (UL)	1800	880,000	5,250,000	165	170M6420 <sup>2</sup>	170M6470	170M6520 <sup>2</sup>	170M6570
		550 V a.c. (IEC) / 500 V a.c. (UL)	2000	1,150,000	6,350,000	175	170M6421	170M6471	170M6521	170M6571

<sup>1</sup> 170M6465 and 170M6467 rated at 800 V d.c. UL 85kA 3ms TC when two fuses are connected in series

<sup>2</sup> 170M6420 and 170M6520 rated at 750 V d.c. 12XIn 130 kA when two fuses are connected in series

Data sheets: 170K6314 (Size 1\*), 170K6316 (Size 1), 170K6318 (Size 2), 170K6320 (Size 3)

**170M - Sizes 1\* to 3, Flush end contact, 690 V a.c. (IEC), 700 V a.c. (UL), 40 A to 2000 A**

Time-current curve - Size 1\*, 40 A to 630 A

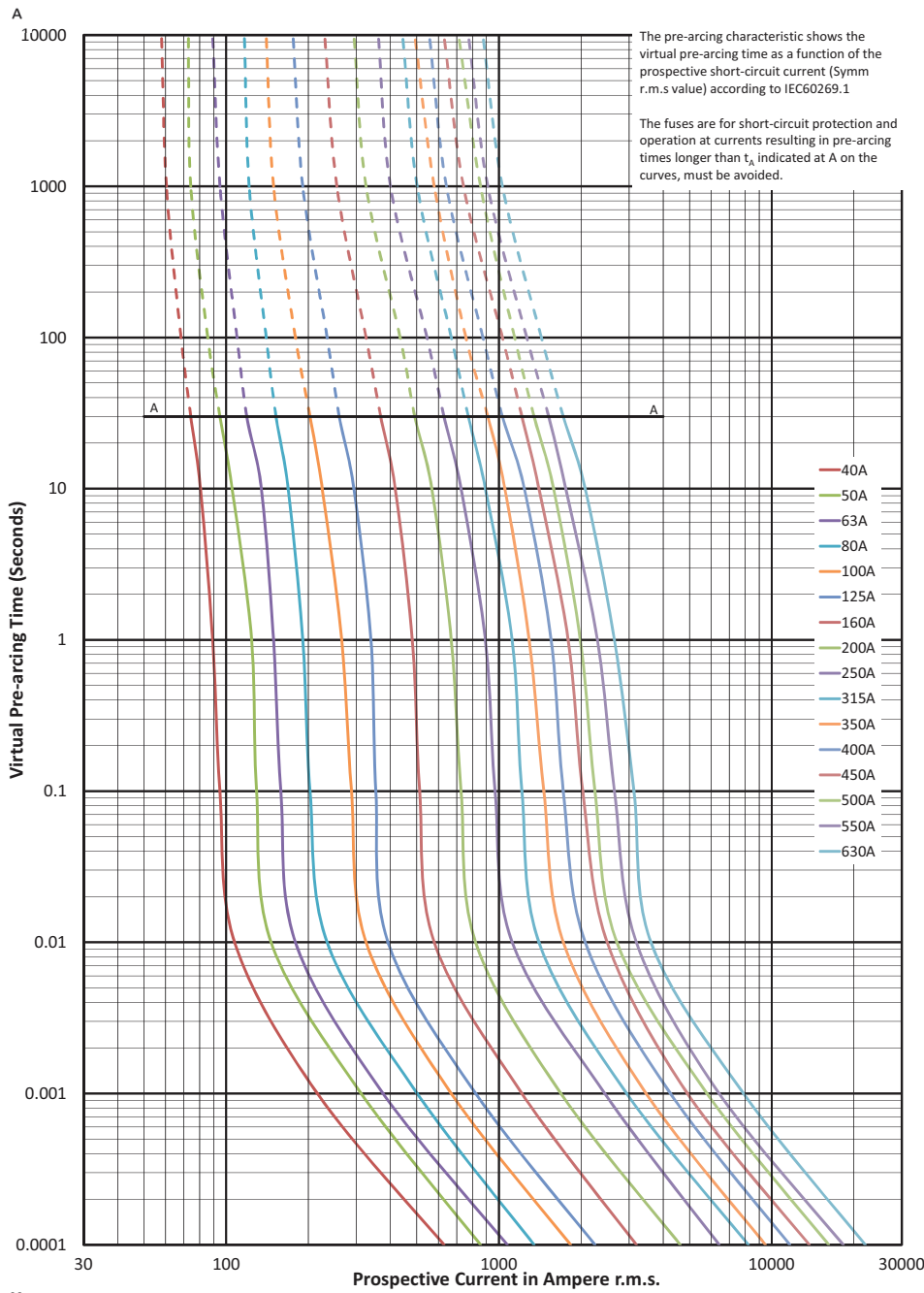

$K_b = 1$   $N = 1,5$

# Square body fuse links

## 170M - Sizes 1\* to 3, Flush end contact, 690 V a.c. (IEC), 700 V a.c. (UL), 40 A to 2000 A

### Cut-off curve - Size 1\*, 40 A to 630 A

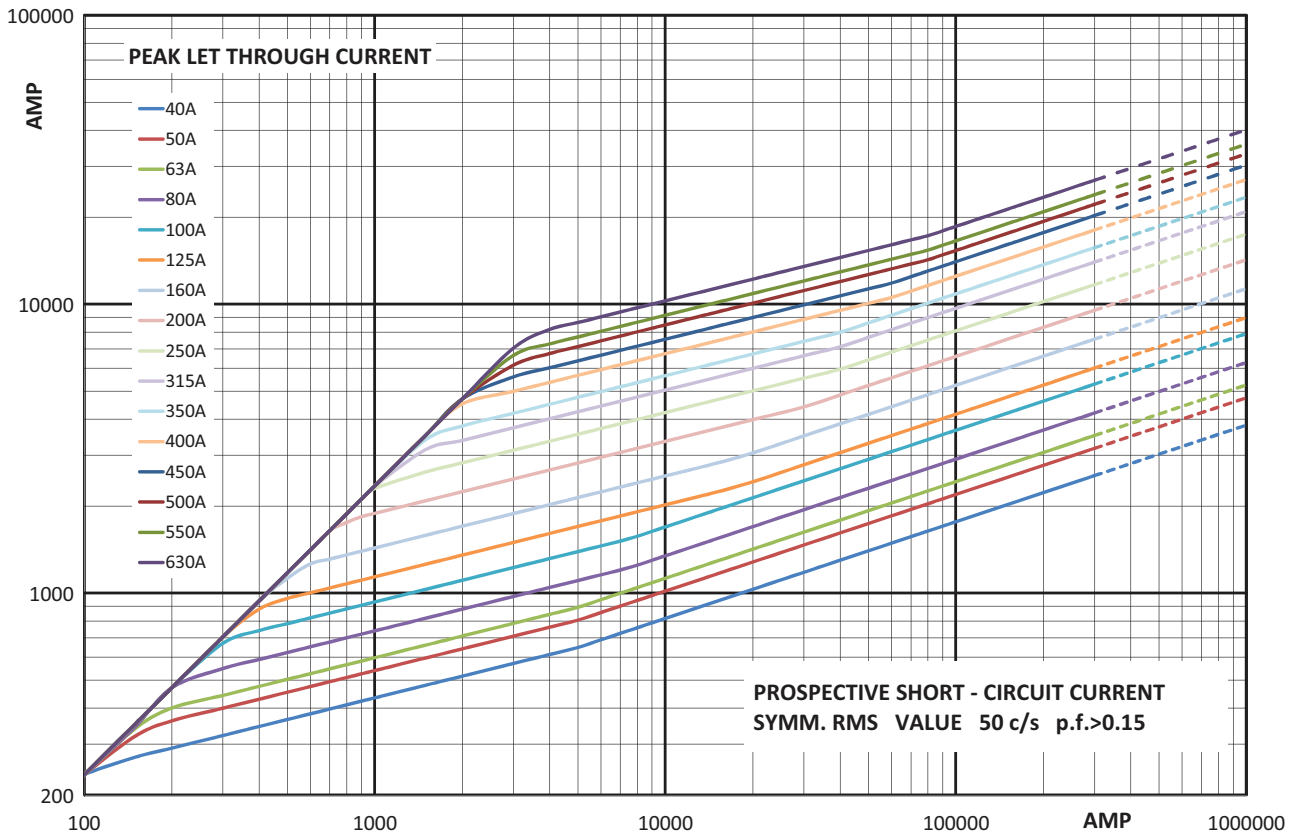

### Total clearing $I^2t$

The total clearing  $I^2t$  at rated voltage and at a power factor of 15 percent are given in the electrical characteristics. For other voltages, the clearing  $I^2t$  is found by multiplying by correction factor, K, given as a function of applied working voltage,  $E_g$ , (RMS).

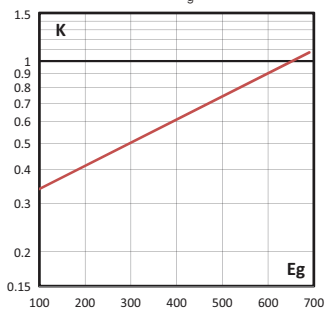

### Arc voltage

This curve gives the peak arc voltage,  $U_L$ , which may appear across the fuse during its operation as a function of the applied working voltage,  $E_g$ , (RMS) at a power factor of 15 percent.

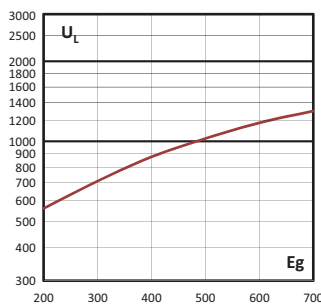

### Watts losses

Watts loss at rated current is given in the electrical characteristics. The curve allows the calculation of the watts losses at load currents lower than the rated current. The correction factor,  $K_p$ , is given as a function of the RMS load current,  $I_b$ , in percent of the rated current.

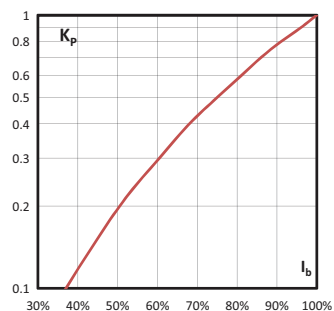

Data sheets: 170K6314 (Size 1\*), 170K6316 (Size 1), 170K6318 (Size 2), 170K6320 (Size 3)



**170M - Sizes 1\* to 3, Flush end contact, 690 V a.c. (IEC), 700 V a.c. (UL), 40 A to 2000 A**

Time-current curve - Size 1, 200 A to 900 A

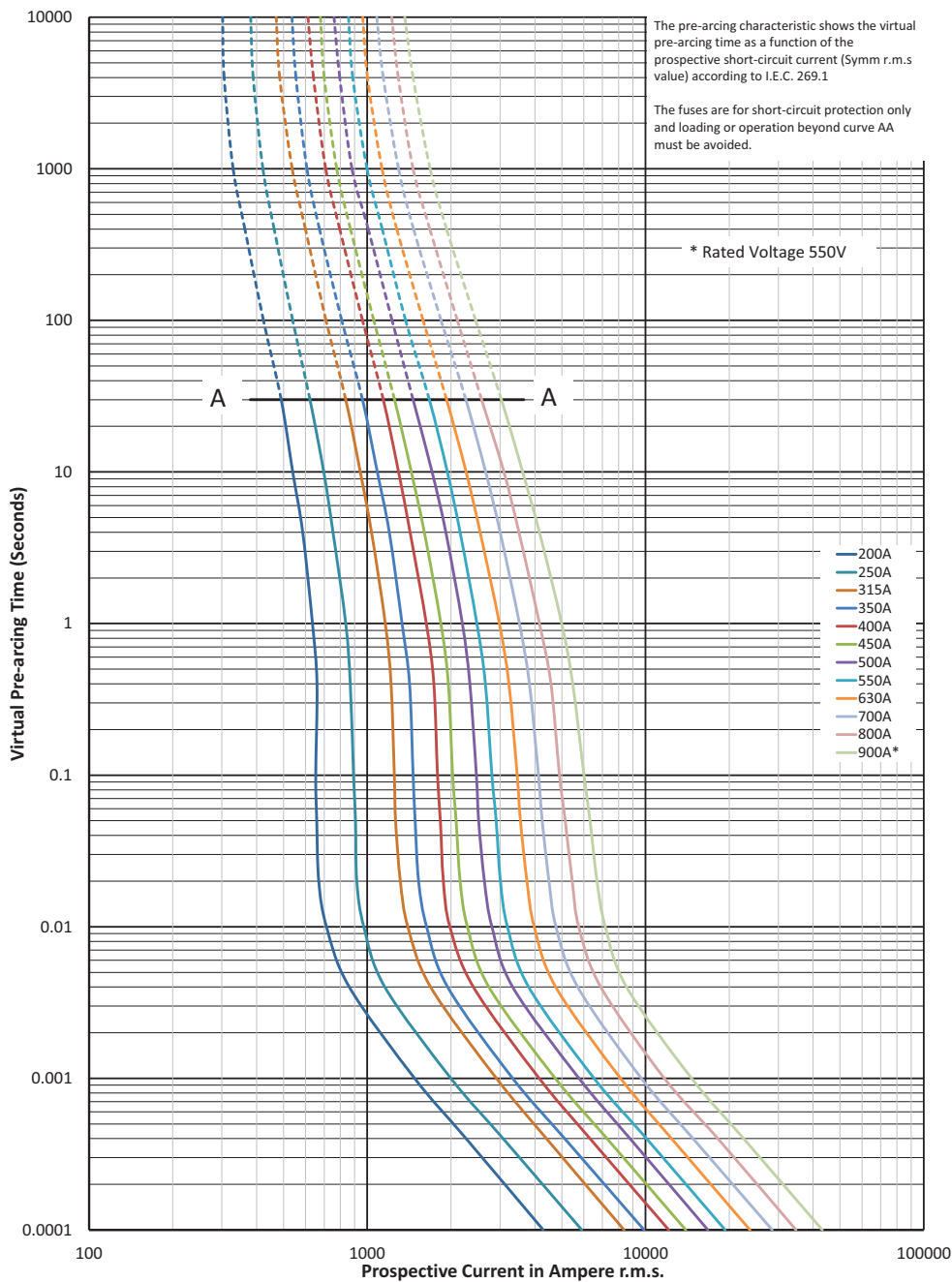

$K_b = 1$   $N = 1.5$

# Square body fuse links

## 170M - Sizes 1\* to 3, Flush end contact, 690 V a.c. (IEC), 700 V a.c. (UL), 40 A to 2000 A

### Cut-off curve - Size 1, 200 A to 900 A

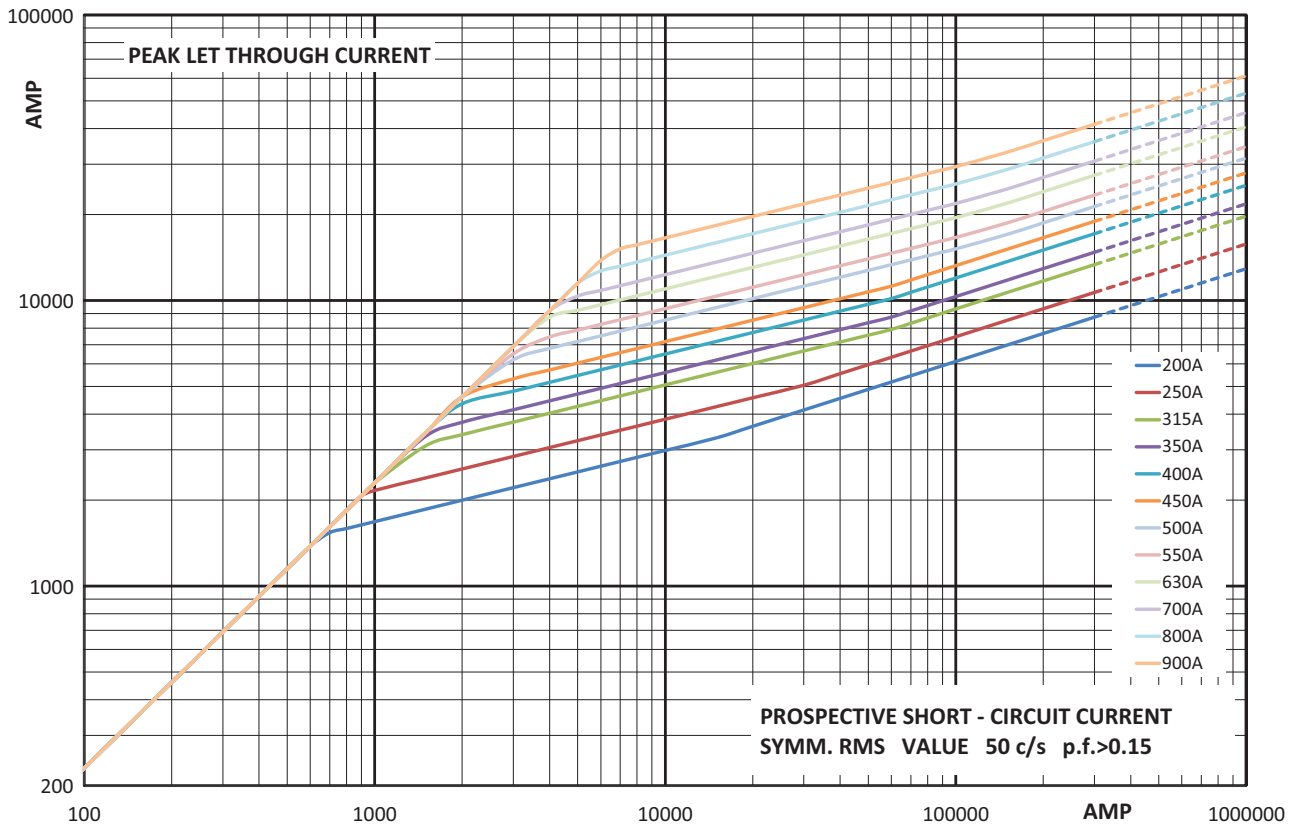

### Total clearing $I^2t$

The total clearing  $I^2t$  at rated voltage and at a power factor of 15 percent are given in the electrical characteristics. For other voltages, the clearing  $I^2t$  is found by multiplying by correction factor,  $K$ , given as a function of applied working voltage,  $E_g$ , (RMS).

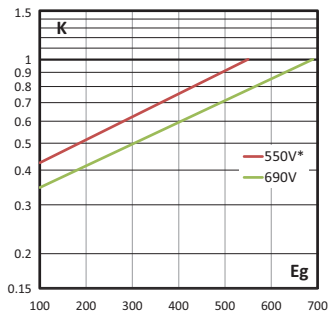

### Arc voltage

This curve gives the peak arc voltage,  $U_L$ , which may appear across the fuse during its operation as a function of the applied working voltage,  $E_g$ , (RMS) at a power factor of 15 percent.

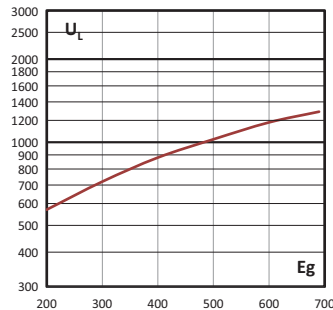

### Watts losses

Watts loss at rated current is given in the electrical characteristics. The curve allows the calculation of the watts losses at load currents lower than the rated current. The correction factor,  $K_p$ , is given as a function of the RMS load current,  $I_b$ , in percent of the rated current.

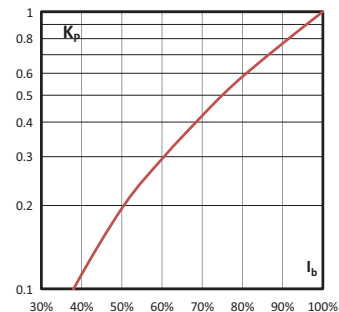

**170M** - Sizes 1\* to 3, Flush end contact, 690 V a.c. (IEC), 700 V a.c. (UL), 40 A to 2000 A

Time-current curve - Size 2, 400 A to 1250 A

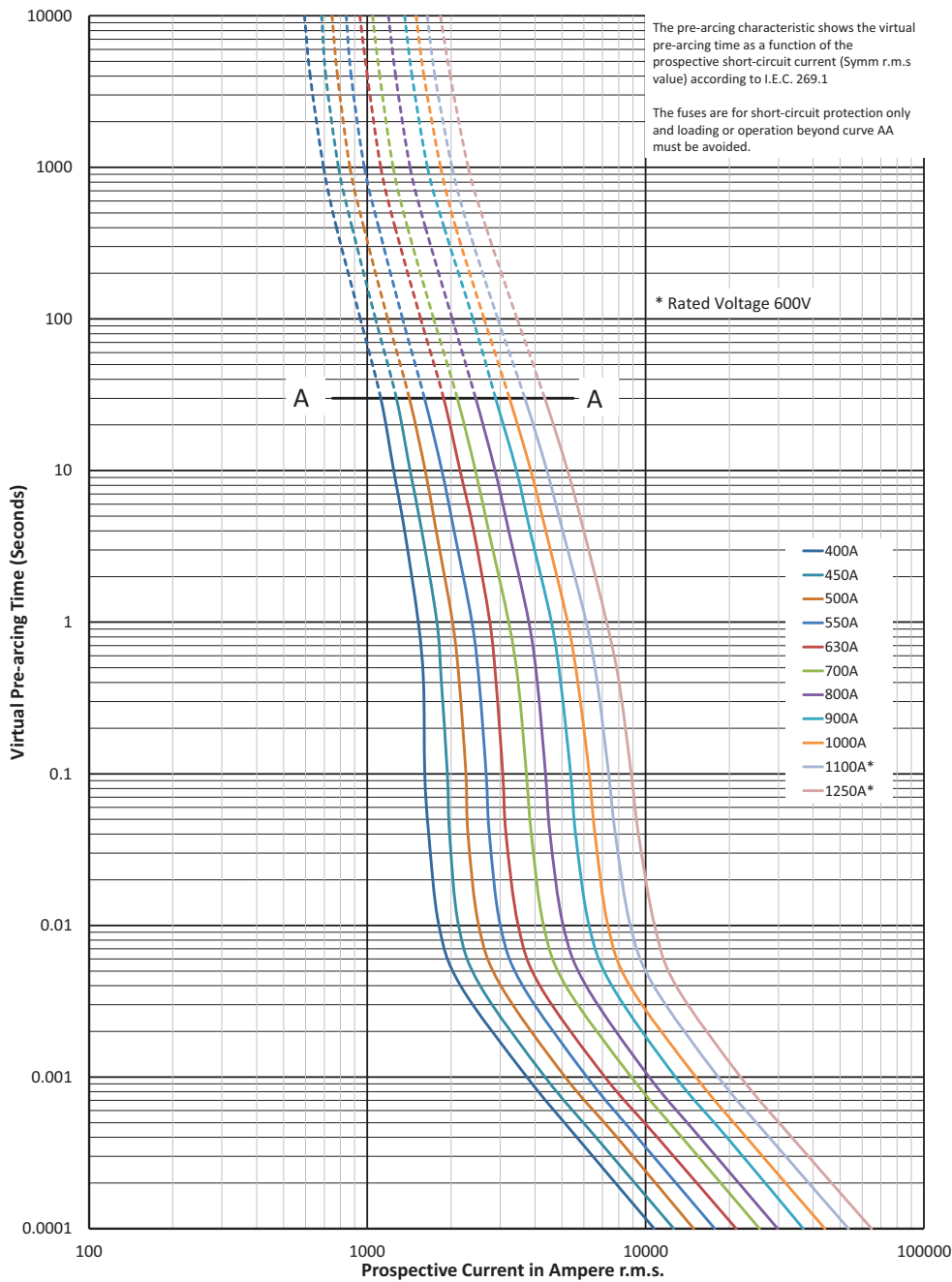

$K_b = 1$     $N = 1.5$

# Square body fuse links

## 170M - Sizes 1\* to 3, Flush end contact, 690 V a.c. (IEC), 700 V a.c. (UL), 40 A to 2000 A

### Cut-off curve - Size 2, 400 A to 1250 A

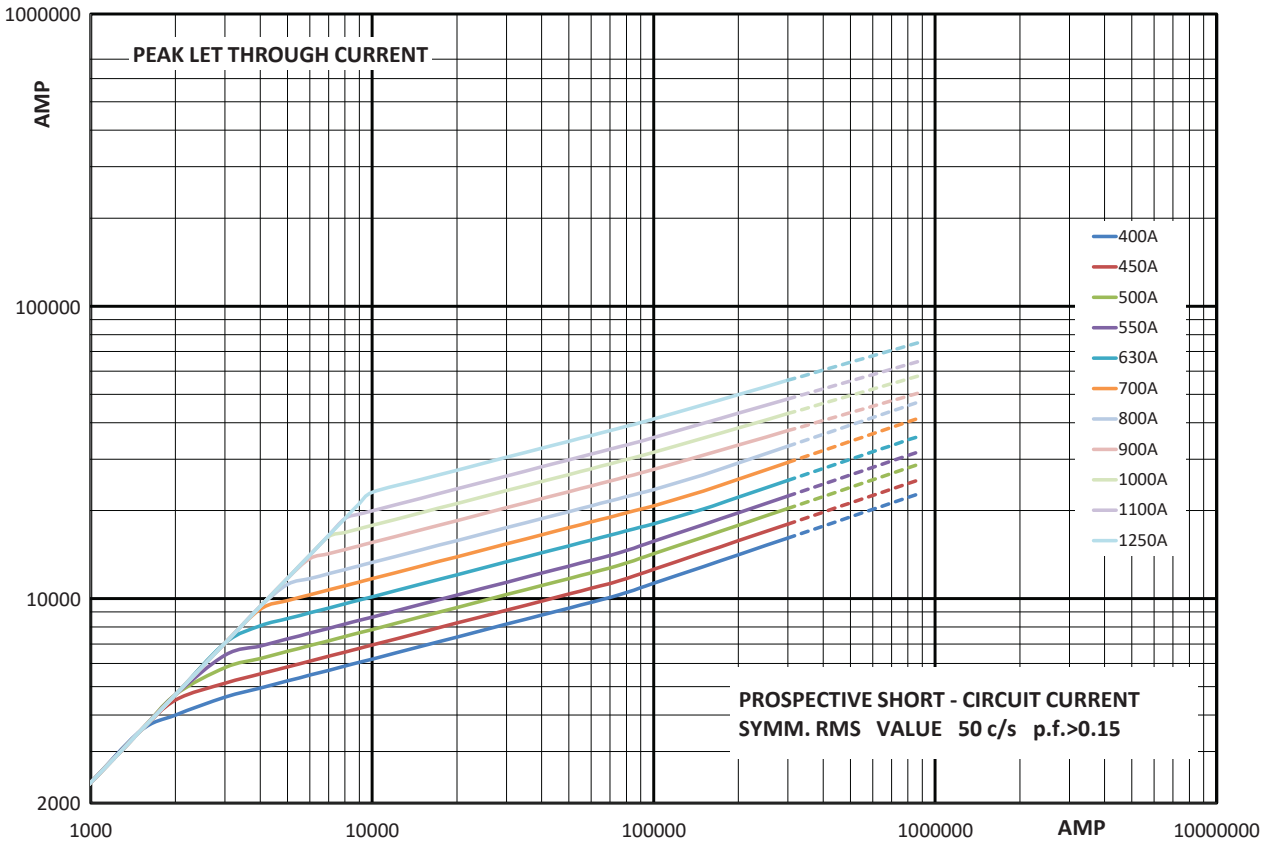

### Total clearing $I^2t$

The total clearing  $I^2t$  at rated voltage and at a power factor of 15 percent are given in the electrical characteristics. For other voltages, the clearing  $I^2t$  is found by multiplying by correction factor,  $K$ , given as a function of applied working voltage,  $E_g$ , (RMS).

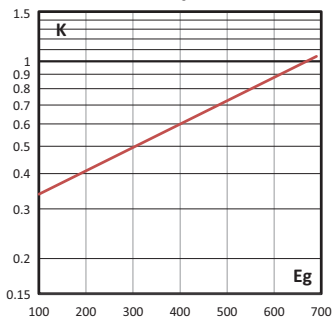

### Arc voltage

This curve gives the peak arc voltage,  $U_L$ , which may appear across the fuse during its operation as a function of the applied working voltage,  $E_g$ , (RMS) at a power factor of 15 percent.

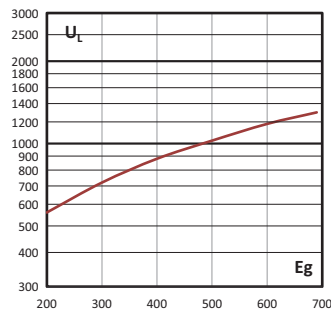

### Watts losses

Watts loss at rated current is given in the electrical characteristics. The curve allows the calculation of the watts losses at load currents lower than the rated current. The correction factor,  $K_p$ , is given as a function of the RMS load current,  $I_b$ , in percent of the rated current.

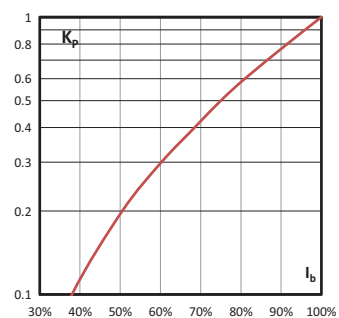

**170M - Sizes 1\* to 3, Flush end contact, 690 V a.c. (IEC), 700 V a.c. (UL), 40 A to 2000 A**

Time-current curve - Size 3, 500 A to 2000 A

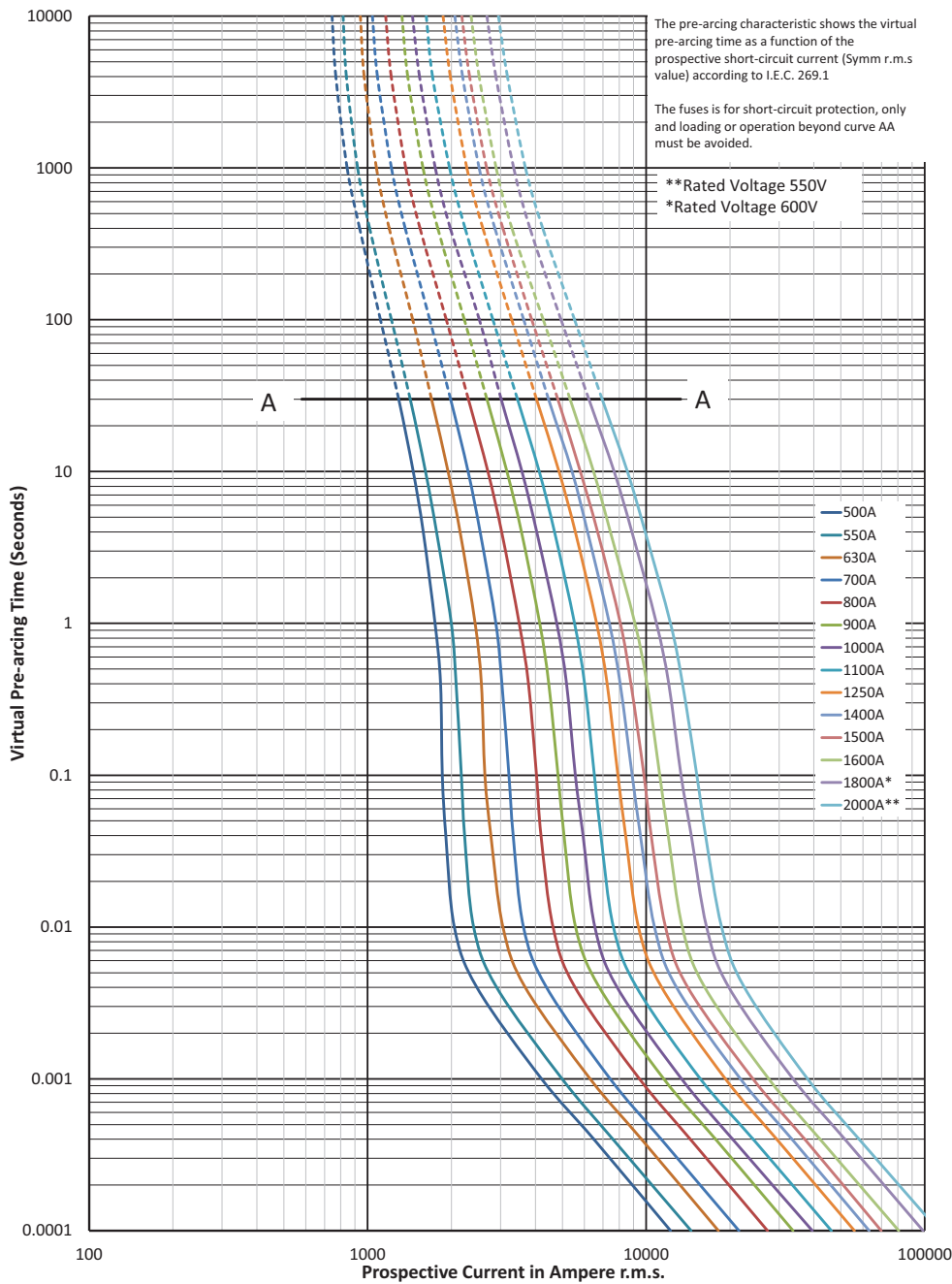

$K_b = 1$     $N = 1.5$

# Square body fuse links

## 170M - Sizes 1\* to 3, Flush end contact, 690 V a.c. (IEC), 700 V a.c. (UL), 40 A to 2000 A

### Cut-off curve - Size 3, 500 A to 2000 A

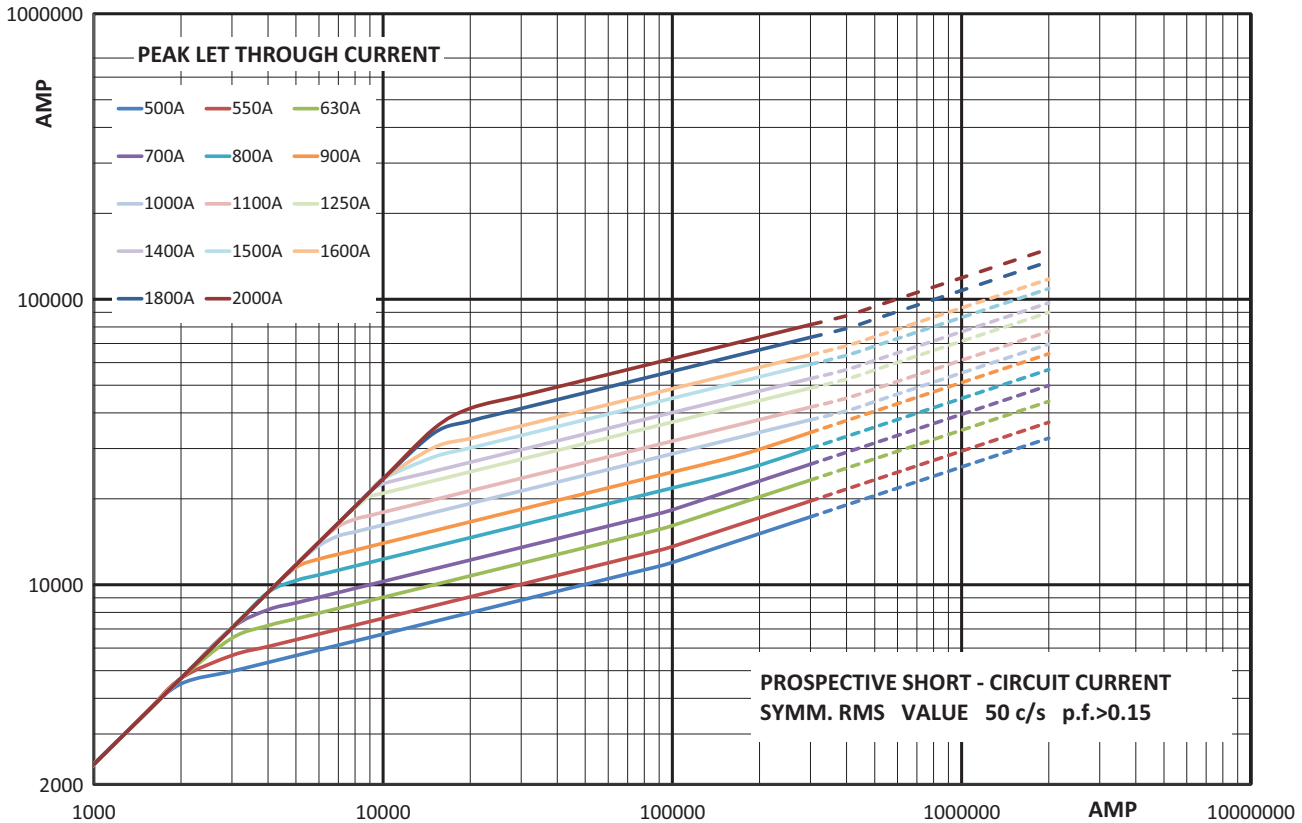

### Total clearing $I^2t$

The total clearing  $I^2t$  at rated voltage and at a power factor of 15 percent are given in the electrical characteristics. For other voltages, the clearing  $I^2t$  is found by multiplying by correction factor,  $K$ , given as a function of applied working voltage,  $E_g$ , (RMS).

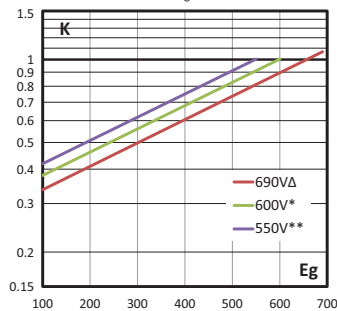

### Arc voltage

This curve gives the peak arc voltage,  $U_L$ , which may appear across the fuse during its operation as a function of the applied working voltage,  $E_g$ , (RMS) at a power factor of 15 percent.

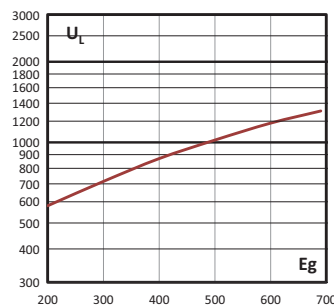

### Watts losses

Watts loss at rated current is given in the electrical characteristics. The curve allows the calculation of the watts losses at load currents lower than the rated current. The correction factor,  $K_p$ , is given as a function of the RMS load current,  $I_b$ , in percent of the rated current.

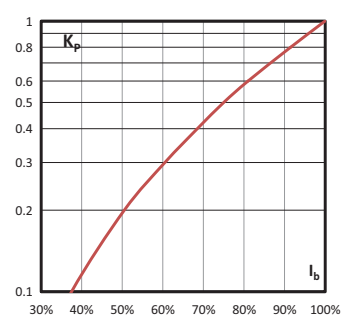

## 170M - sizes 1\* to 3, Flush end contact, 1000 V a.c. (IEC and UL), 50 A to 1400 A

### Specifications

#### Description

Square body flush end contact high speed fuse links, for the protection of DC common bus, DC drives, power converters/rectifiers and reduced rated voltage starters.

#### Technical data

- Rated voltage:
  - 1000 V a.c. (IEC, 50 A to 1250 A)
  - 1000 V a.c. (UL, 250 A to 1100 A)
  - 900 V a.c. (IEC, 1400 A)
- Rated current: 50 A to 1400 A
- Breaking capacity:
  - 125kA RMS Sym. AC
  - Size 1 DC 750 V d.c. 50 kA IR
- Operating class: aR

#### Standards / Agency information

CE, Designed and tested to IEC 60269 Part 4, UL Recognised for size 2 and 3 (only up to 1100 A)



#### Dimensions (mm)

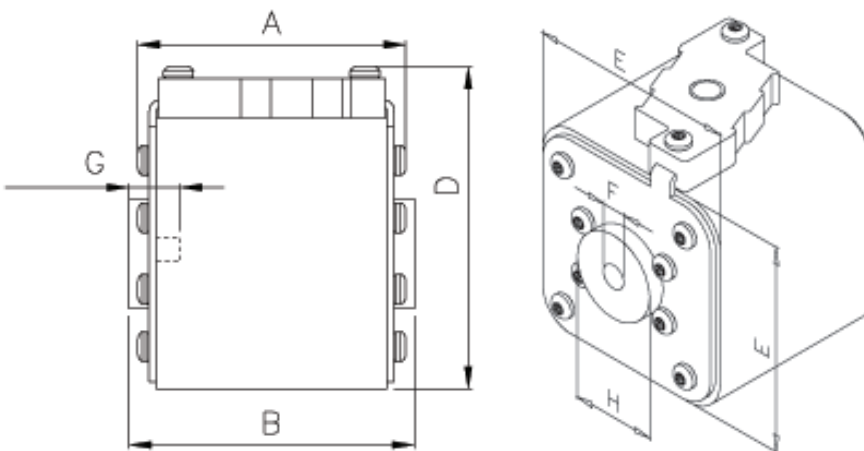

Size	Type	A	B	D (max)	E	F	F' (in)	G (min)	H
1*	BKN/75 + GKN/75	72.5	74	61	43	M8	5/16" 18 UNC-2B	5	17.5
1	BKN/75 + GKN/75	73.2	74	69	52	M8	5/16" 18 UNC-2B	8	20
2	BKN/75 + GKN/75	73.2	74.4	77	59	M10	3/8" 16 UNC-2B	10	24.5
3	BKN/75 + GKN/75	73.3	75.4	92	74	M12	1/2" 13 UNC-2B	10	30
3	BKN/90 + GKN/90	80.3	91.4	92	74	M12	1/2" 13 UNC-2B	10	30

<sup>1</sup> Valid for fuses type -GKN/-.

# Square body fuse links

## 170M - sizes 1\* to 3, Flush end contact, 1000 V a.c. (IEC and UL), 50 A to 1400 A

### Catalogue numbers

Fuse link body size	Rated voltage	I <sup>2</sup> t (A <sup>2</sup> Sec)			Watts loss (W)	Catalogue numbers		
		Rated current (Amps)	Pre-arcing	Clearing at rated voltage		-BKN/- Type K indicator for micro	-GKN/- Type K indicator for micro	
1*	1000 V a.c. (IEC)	50	135	815	20	170M3951	170M3921	
		63	215	1300	25	170M3952	170M3922	
		80	460	2750	30	170M3953	170M3923	
		100	860	5100	35	170M3954	170M3924	
		125	1450	8600	40	170M3955	170M3925	
		160	2850	17,500	45	170M3956	170M3926	
		200	4950	29,500	50	170M3957	170M3927	
		250	9550	57,000	55	170M3958	170M3928	
		315	21,500	130,000	65	170M3959	170M3929	
		350	29,000	175,000	70	170M3960	170M3930	
		400	42,000	250,000	75	170M3961	170M3931	
1	1000 V a.c. (IEC)	160	2200	13,500	40	170M4951	170M4921	
		200	4150	24,500	45	170M4952	170M4922	
		250	7750	46,000	52	170M4953	170M4923	
		315	16,500	98,500	60	170M4954	170M4924	
	1000 V a.c. / 750 V d.c. (UL)	350	21,500	130,000	65	170M4955	170M4925	
		400	31,000	185,000	70	170M4956	170M4926	
		450	44,500	265,000	80	170M4957	170M4927	
		500	63,000	375,000	85	170M4958	170M4928	
2	1000 V a.c. (IEC/UL)	550	84,500	500,000	90	170M4959	170M4929	
		630	125,000	755,000	98	170M4960	170M4930	
		250	6750	40,000	65	170M5952	170M5922	
		315	13,500	81,500	75	170M5953	170M5923	
		350	16,500	99,000	80	170M5954	170M5924	
		400	26,000	155,000	85	170M5955	170M5925	
		450	35,500	210,000	90	170M5956	170M5926	
		500	49,500	295,000	95	170M5957	170M5927	
		550	66,000	390,000	100	170M5958	170M5928	
		630	93,500	555,000	110	170M5959	170M5929	
3	1000 V a.c. (IEC/UL)	700	130,000	770,000	115	170M5960	170M5930	
		800	195,000	1,200,000	125	170M5961	170M5931	
		315	9200	54,500	90	170M8600	170M8500	
		350	13,000	77,500	95	170M8601	170M8501	
		400	19,000	115,000	105	170M8602	170M8502	
		450	27,000	160,000	107	170M8603	170M8503	
		500	37,500	225,000	110	170M8604	170M8504	
		550	52,000	310,000	115	170M8605	170M8505	
		630	82,500	490,000	120	170M8606	170M8506	
		700	115,000	700,000	125	170M8607	170M8507	
		800	170,000	1,050,000	135	170M8608	170M8508	
3	1000 V a.c. (IEC)	900	250,000	1,500,000	145	170M8609	170M8509	
		1000	340,000	2,050,000	150	170M8610	170M8510	
		1100	460,000	2,750,000	155	170M8611	170M8511	
		1250	575,000	3,400,000	175	170M8612 <sup>1</sup>	170M8512 <sup>1</sup>	
		1400	795,000	4,200,000	185	170M8613 <sup>1</sup>	170M8513 <sup>1</sup>	
		900 V a.c. (IEC)	1400	795,000	4,200,000	185	170M8613 <sup>1</sup>	170M8513 <sup>1</sup>

<sup>1</sup> Overall length is 90 mm, for all other fuse links the overall length is 75 mm.



**170M** - sizes 1\* to 3, Flush end contact, 1000 V a.c. (IEC and UL), 50 A to 1400 A

Time-current curve - Size 1\*, 50 A to 400 A

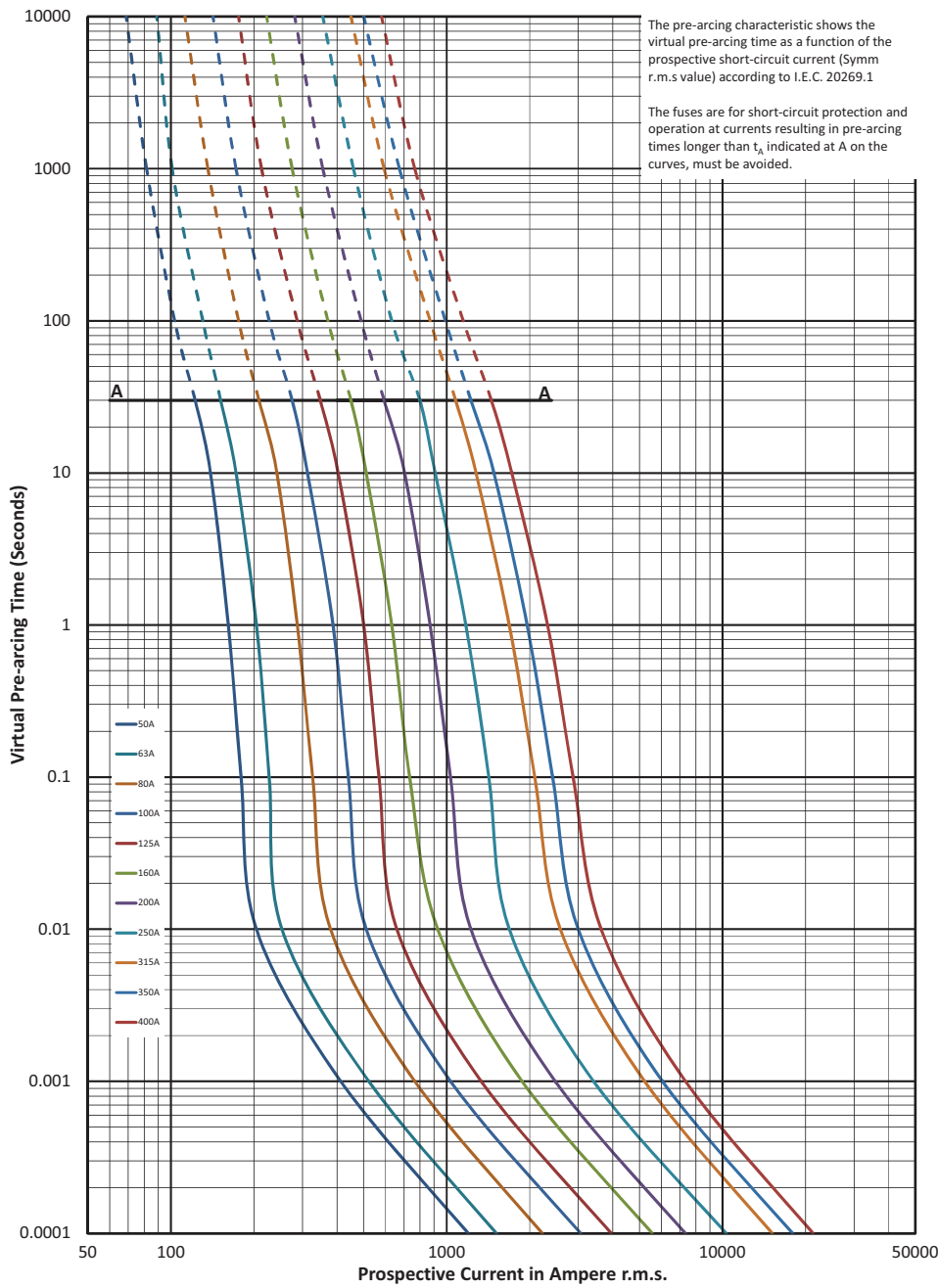

Data sheets: 170K8564 (Size 1\*), 170K8566 (Size 1), 170K8568 (Size 2), 170K8570 (Size 3)

# Square body fuse links

## 170M - sizes 1\* to 3, Flush end contact, 1000 V a.c. (IEC and UL), 50 A to 1400 A

### Cut-off curve - Size 1\*, 50 A to 400 A

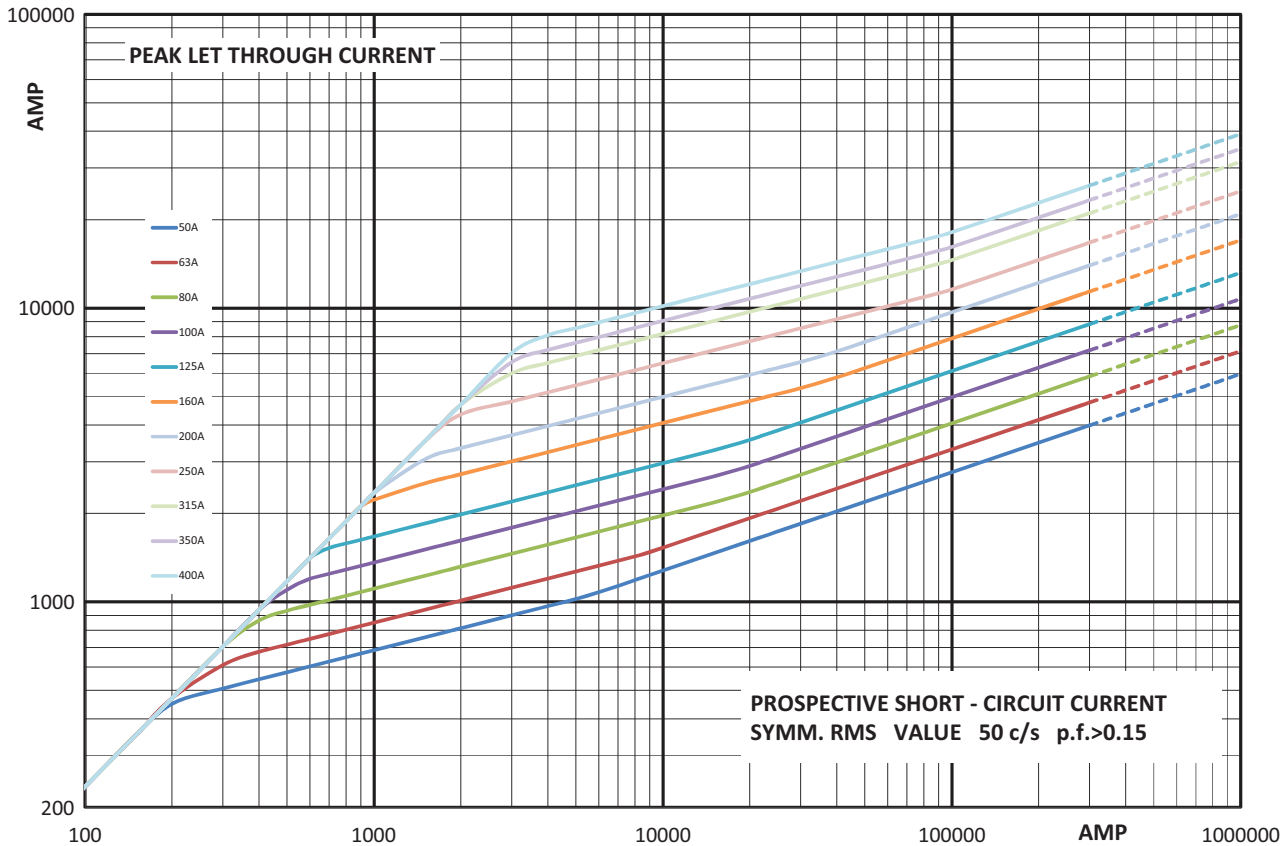

### Total clearing $I^2t$

The total clearing  $I^2t$  at rated voltage and at a power factor of 15 percent are given in the electrical characteristics. For other voltages, the clearing  $I^2t$  is found by multiplying by correction factor,  $K$ , given as a function of applied working voltage,  $E_g$ , (RMS).

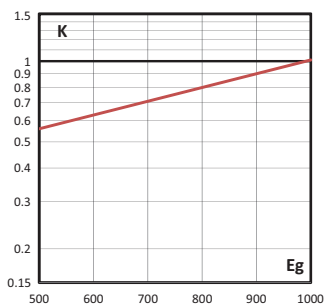

### Arc voltage

This curve gives the peak arc voltage,  $U_L$ , which may appear across the fuse during its operation as a function of the applied working voltage,  $E_g$ , (RMS) at a power factor of 15 percent.

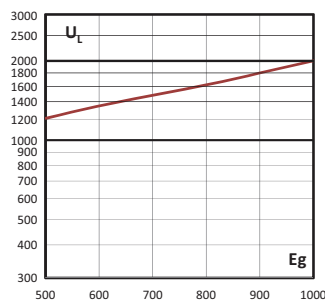

### Watts losses

Watts loss at rated current is given in the electrical characteristics. The curve allows the calculation of the watts losses at load currents lower than the rated current. The correction factor,  $K_p$ , is given as a function of the RMS load current,  $I_b$ , in percent of the rated current.

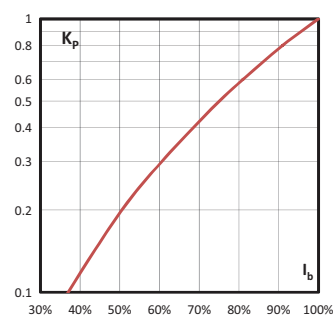

**170M - Sizes 1\* to 3, Flush end contact, 1000 V a.c. (IEC and UL), 50 A to 1400 A**

Time-current curve - Size 1, 160 A to 630 A

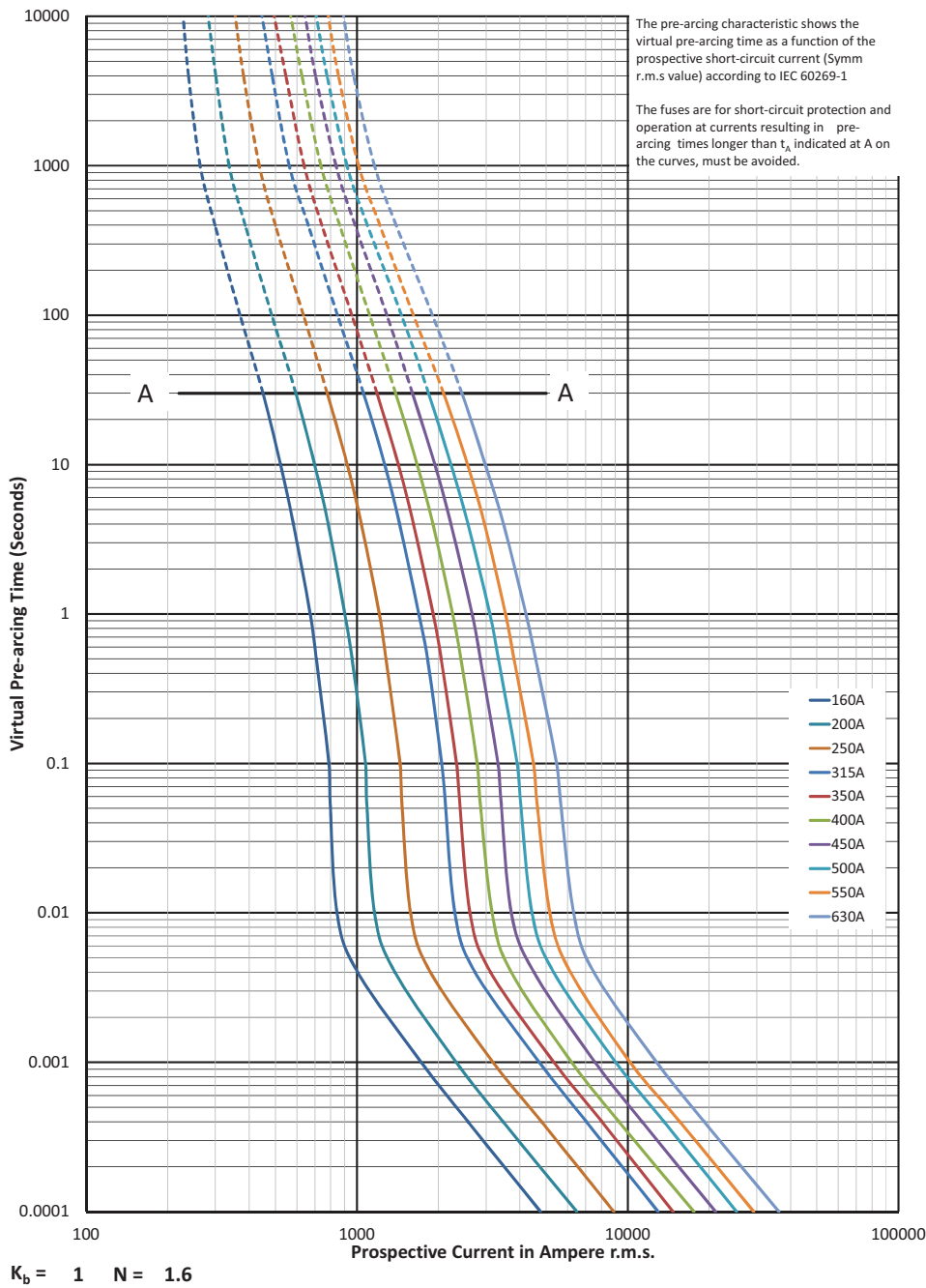

Data sheets: 170K8564 (Size 1\*), 170K8566 (Size 1), 170K8568 (Size 2), 170K8570 (Size 3)

# Square body fuse links

## 170M - Sizes 1\* to 3, Flush end contact, 1000 V a.c. (IEC and UL), 50 A to 1400 A

### Cut-off curve - Size 1, 160 A to 630 A

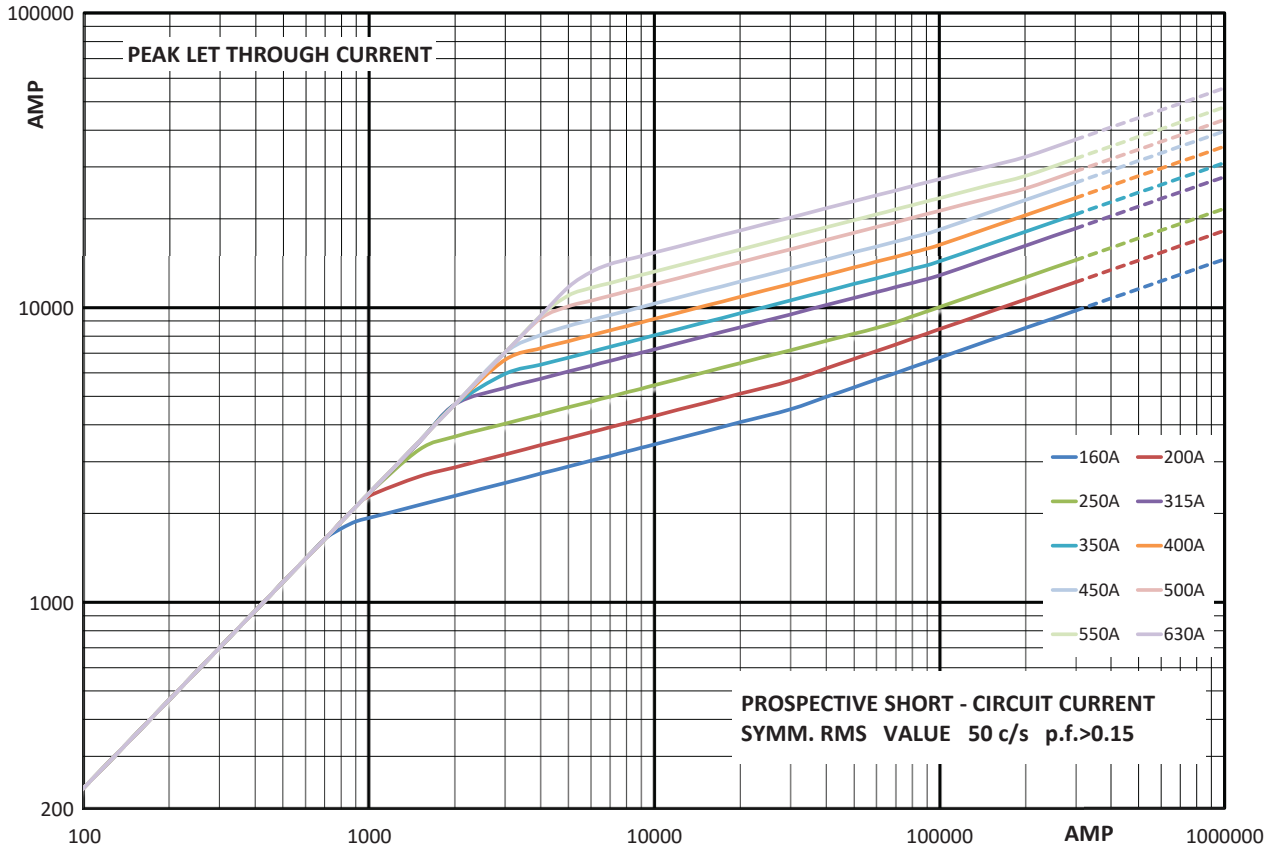

### Total clearing $I^2t$

The total clearing  $I^2t$  at rated voltage and at a power factor of 15 percent are given in the electrical characteristics. For other voltages, the clearing  $I^2t$  is found by multiplying by correction factor,  $K$ , given as a function of applied working voltage,  $E_g$ , (RMS).

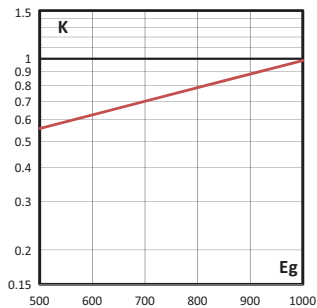

### Arc voltage

This curve gives the peak arc voltage,  $U_t$ , which may appear across the fuse during its operation as a function of the applied working voltage,  $E_g$ , (RMS) at a power factor of 15 percent.

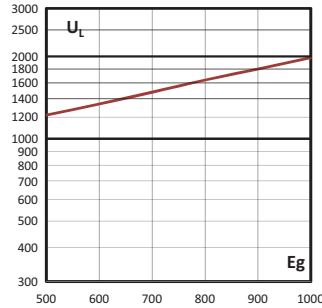

### Watts losses

Watts loss at rated current is given in the electrical characteristics. The curve allows the calculation of the watts losses at load currents lower than the rated current. The correction factor,  $K_p$ , is given as a function of the RMS load current,  $I_b$ , in percent of the rated current.

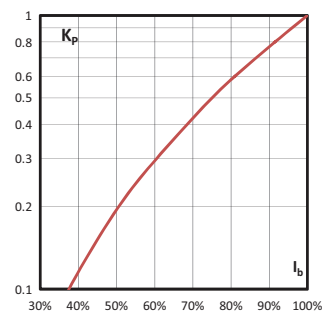

**170M - Sizes 1\* to 3, Flush end contact, 1000 V a.c. (IEC and UL), 50 A to 1400 A**

**Time-current curve - Size 2, 250 A to 800 A**

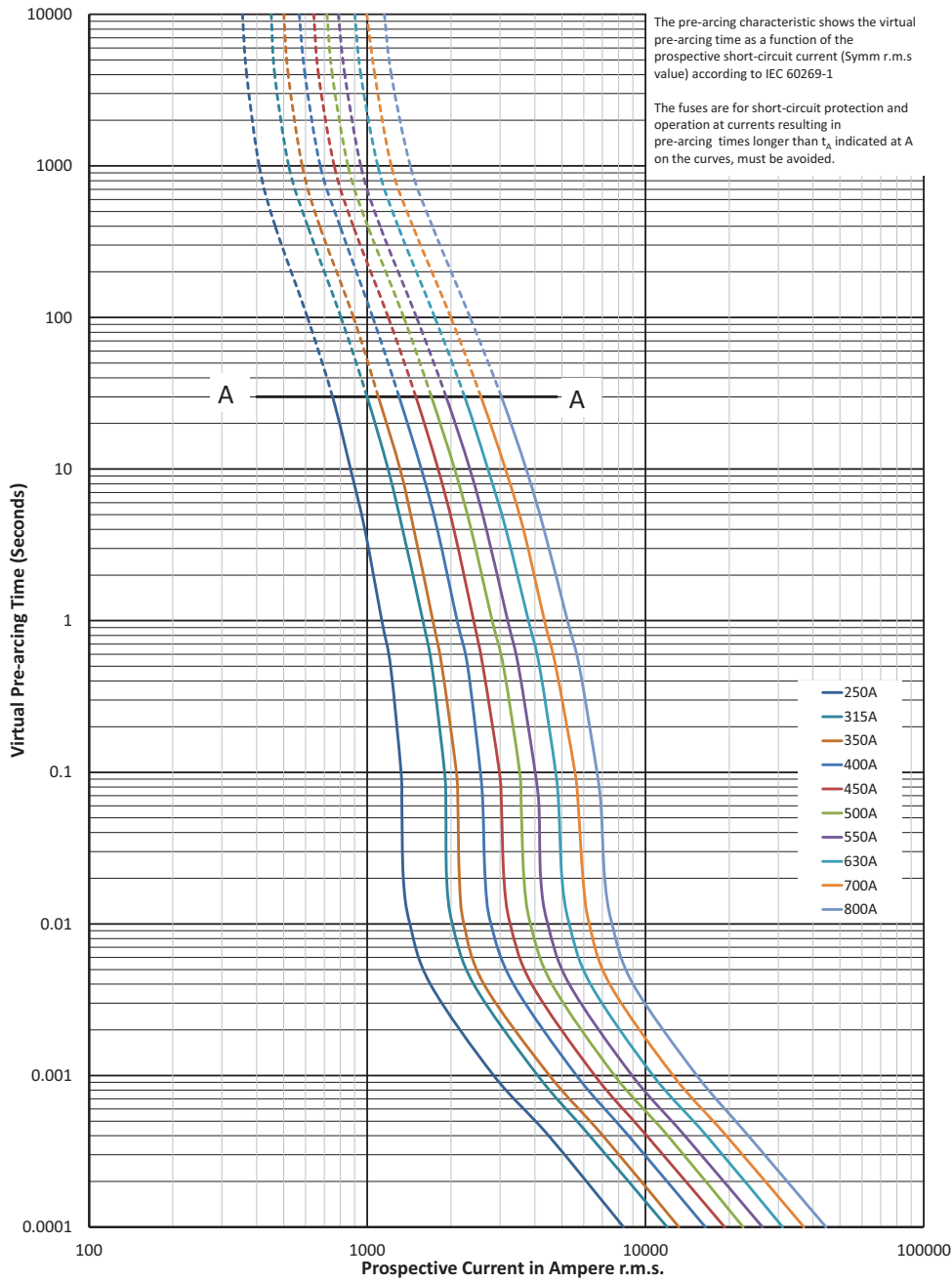

Data sheets: 170K8564 (Size 1\*), 170K8566 (Size 1), 170K8568 (Size 2), 170K8570 (Size 3)

# Square body fuse links

## 170M - Sizes 1\* to 3, Flush end contact, 1000 V a.c. (IEC and UL), 50 A to 1400 A

### Cut-off curve - Size 2, 250 A to 800 A

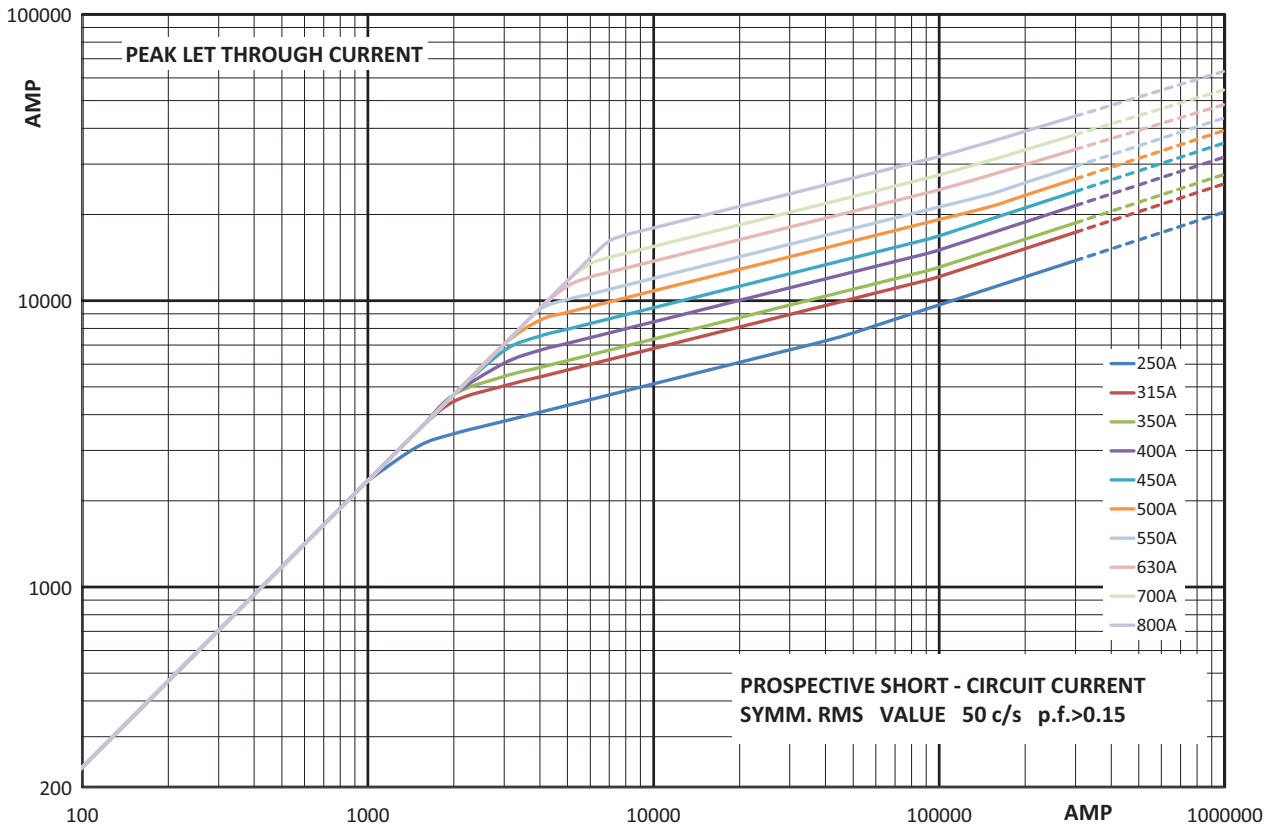

### Total clearing $I^2t$

The total clearing  $I^2t$  at rated voltage and at a power factor of 15 percent are given in the electrical characteristics. For other voltages, the clearing  $I^2t$  is found by multiplying by correction factor,  $K$ , given as a function of applied working voltage,  $E_g$ , (RMS).

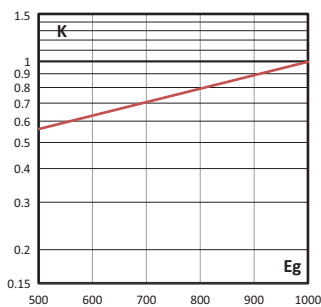

### Arc voltage

This curve gives the peak arc voltage,  $U_L$ , which may appear across the fuse during its operation as a function of the applied working voltage,  $E_g$ , (RMS) at a power factor of 15 percent.

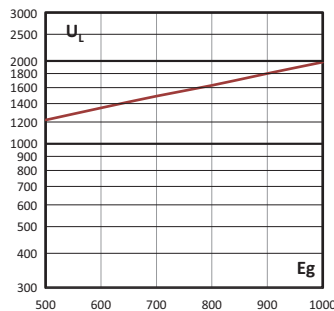

### Watts losses

Watts loss at rated current is given in the electrical characteristics. The curve allows the calculation of the watts losses at load currents lower than the rated current. The correction factor,  $K_p$ , is given as a function of the RMS load current,  $I_b$ , in percent of the rated current.

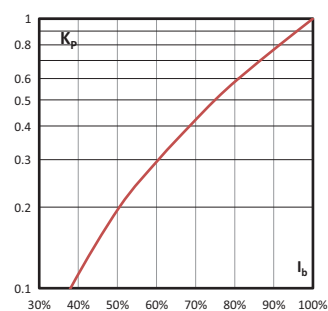

**170M** - Sizes 1\* to 3, Flush end contact, 1000 V a.c. (IEC and UL), 50 A to 1400 A

Time-current curve - Size 3, 315 A to 1400 A

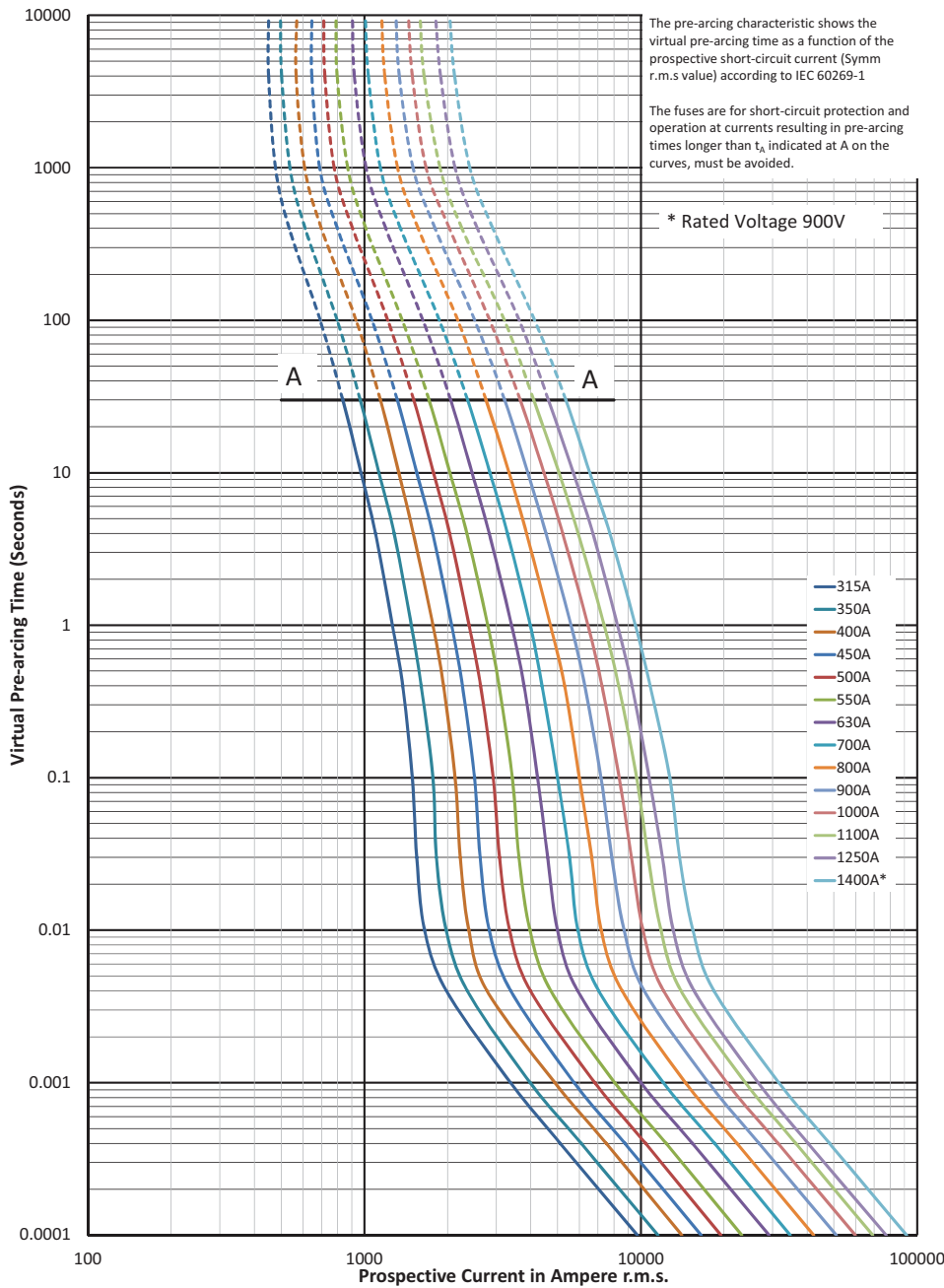

# Square body fuse links

## 170M - Sizes 1\* to 3, Flush end contact, 1000 V a.c. (IEC and UL), 50 A to 1400 A

### Cut-off curve - Size 3, 315 A to 1400 A

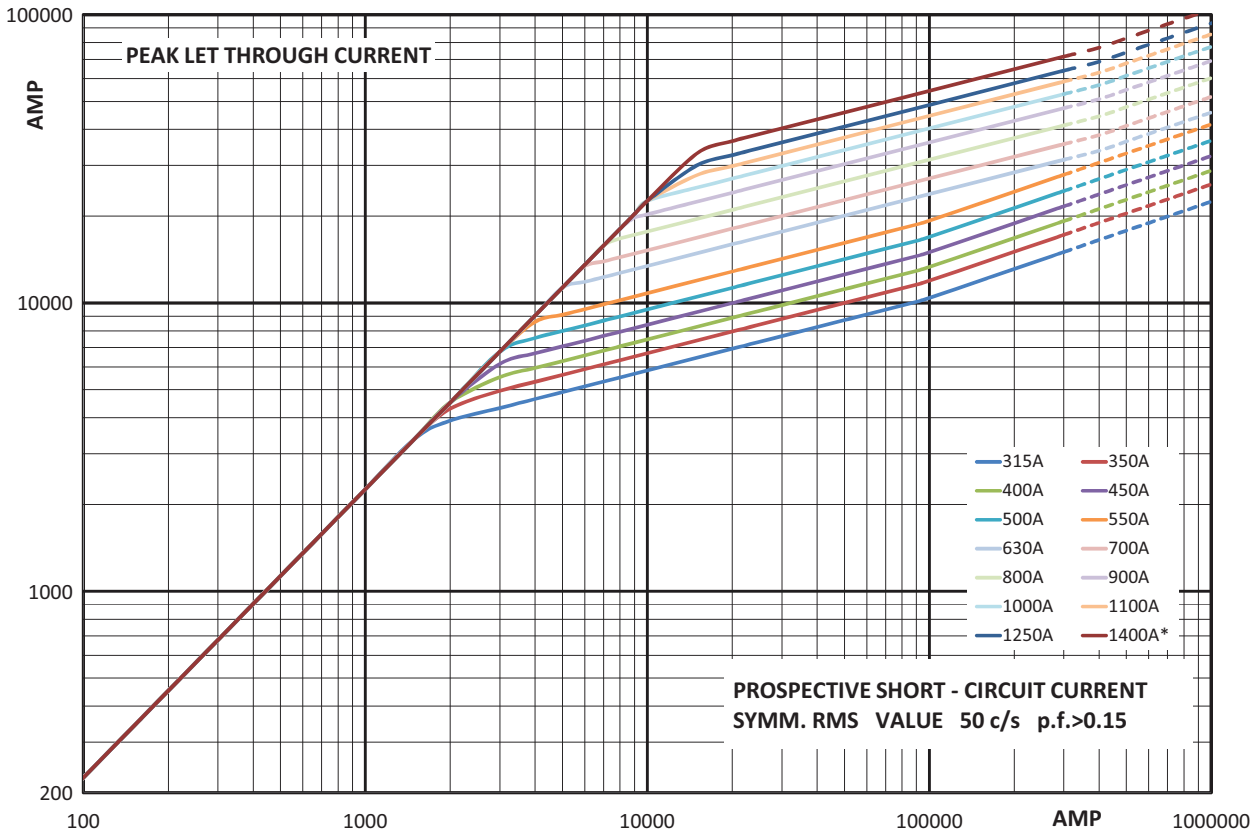

### Total clearing $I^2t$

The total clearing  $I^2t$  at rated voltage and at a power factor of 15 percent are given in the electrical characteristics. For other voltages, the clearing  $I^2t$  is found by multiplying by correction factor,  $K$ , given as a function of applied working voltage,  $E_g$ , (RMS).

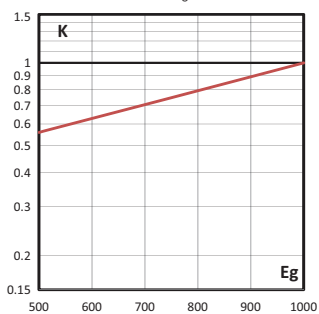

### Arc voltage

This curve gives the peak arc voltage,  $U_L$ , which may appear across the fuse during its operation as a function of the applied working voltage,  $E_g$ , (RMS) at a power factor of 15 percent.

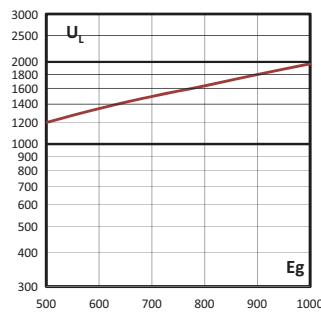

### Watts losses

Watts loss at rated current is given in the electrical characteristics. The curve allows the calculation of the watts losses at load currents lower than the rated current. The correction factor,  $K_p$ , is given as a function of the RMS load current,  $I_b$ , in percent of the rated current.

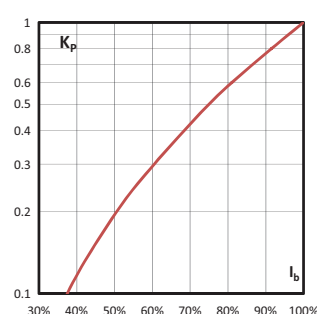



## 170M - Sizes 1\* to 3, Flush end contact, 1250 V a.c. (IEC), 1300 V a.c. (UL), 50 A to 1400 A

### Specifications

#### Description

Square body flush end contact high speed fuse links, for the protection of DC common bus, DC drives, power converters/rectifiers and reduced rated voltage starters.

#### Technical data

- Rated voltage:
  - 1250 V a.c. (IEC)
  - 1300 V a.c. (UL)
- Rated current: 50 A to 1400 A
- Breaking capacity: 100 kA RMS Sym
- Operating class: aR



#### Standards / Agency information

CE, Designed and tested to IEC 60269 Part 4. Consult Eaton for UL Recognition/CSA Component Acceptance Status

#### Dimensions (mm)

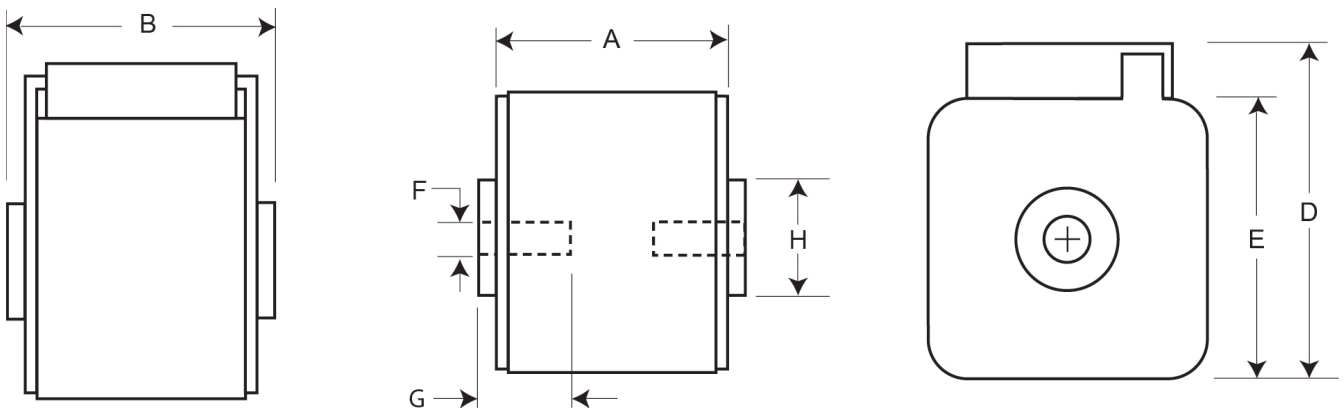

Size	Type	A	B	D	E	F	F <sup>1</sup> (in)	Min G	H
1*	BKN + GKN/75	74	75	59	45	M8	5/16" -18 UNC-2B	5	Ø17
1*	BKN/80	80	81	59	45	M8		5	Ø17
1	BKN + GKN/75	74	75	69	53	M8	5/16" -18 UNC-2B	8	Ø20
1	BKN/80	80	81	69	53	M8		8	Ø20
2	BKN + GKN/75	74	75	77	61	M10	3/8" -16 UNC-2B	10	Ø24
2	BKN/80	80	81	77	61	M10		10	Ø24
2	BKN + GKN/90	80	91	77	61	M10	3/8" -16 UNC-2B	10	Ø24
3	BKN + GKN/75	74	76	92	76	M12	1/2" -13 UNC-2B	10	Ø30
3	BKN/80	81	83	92	76	M12		10	Ø30
3	BKN + GKN/90	81	91	92	76	M12	1/2" -13 UNC-2B	10	Ø30

<sup>1</sup> Valid for fuses type -GKN/-.

# Square body fuse links

## 170M - Sizes 1\* to 3, Flush end contact, 1250 V a.c. (IEC), 1300 V a.c. (UL), 50 A to 1400 A

Fuse link body size	Rated voltage	I <sup>2</sup> t (A <sup>2</sup> Sec)				Watts loss (W)	Catalogue numbers				
		Rated current (Amps)	Pre-arcing	Clearing at 1000 V a.c.	Clearing at 1250 V a.c.		-BKN/75 Type K indicator for micro	-BKN/80 Type K indicator for micro	-BKN/90 Type K Indicator for micro	-GKN/75 Type K Indicator for micro	-GKN/90 Type K Indicator for micro
1*	1250 V a.c. (IEC) 1300 V a.c. (UL)	50	135	815	1100	15	170M3388 <sup>5</sup>	170M3438		170M3488 <sup>6</sup>	
		63	215	1300	1750	20	170M3389 <sup>5</sup>	170M3439		170M3489 <sup>6</sup>	
		80	420	2500	3350	25	170M3390 <sup>5</sup>	170M3440		170M3490 <sup>6</sup>	
		100	750	4450	5950	30	170M3391 <sup>5</sup>	170M3441		170M3491 <sup>6</sup>	
		125	1450	9000	11,500	35	170M3392 <sup>5</sup>	170M3442		170M3492 <sup>6</sup>	
		160	2600	16,000	21,000	40	170M3393 <sup>5</sup>	170M3443		170M3493 <sup>6</sup>	
		200	5150	31,000	41,000	45	170M3394 <sup>5</sup>	170M3444		170M3494 <sup>6</sup>	
		250	9200	54,500	73,000	55	170M3395 <sup>5</sup>	170M3445		170M3495 <sup>6</sup>	
		315	18,500	115,000	150,000	60	170M3396 <sup>5</sup>	170M3446		170M3496 <sup>6</sup>	
		350	27,000	165,000	220,000	65	170M3397 <sup>5</sup>	170M3447		170M3497 <sup>6</sup>	
		400	53,000	265,000	335,000	70		170M3448			
1	1250 V a.c. (IEC) 1300 V a.c. (UL)	160	1900	11,500	15,500	45	170M4388 <sup>5</sup>	170M4438 <sup>5</sup>		170M4488 <sup>6</sup>	
		200	3800	22,500	30,000	50	170M4389 <sup>5</sup>	170M4439 <sup>5</sup>		170M4489 <sup>6</sup>	
		250	7750	46,000	61,500	60	170M4390 <sup>5</sup>	170M4440 <sup>5</sup>		170M4490 <sup>6</sup>	
		315	15,000	90,000	120,000	65	170M4391 <sup>5</sup>	170M4441 <sup>5</sup>		170M4491 <sup>6</sup>	
		350	20,000	125,000	165,000	70	170M4392 <sup>5</sup>	170M4442 <sup>5</sup>		170M4492 <sup>6</sup>	
		400	29,500	175,000	235,000	75	170M4393 <sup>5</sup>	170M4443 <sup>5</sup>		170M4493 <sup>6</sup>	
		450	42,000	250,000	335,000	80	170M4394 <sup>5</sup>	170M4444 <sup>5</sup>		170M4494 <sup>6</sup>	
		500	69,500	340,000	435,000	85	170M4395 <sup>4</sup>	170M4445		170M4495 <sup>4</sup>	
		550	95,000	465,000	590,000	95	170M4396 <sup>5</sup>	170M4446		170M4496 <sup>5</sup>	
630	130,000	660,000	N/A	110	170M4397 <sup>5</sup>	170M4447 <sup>4</sup>		170M4497 <sup>5</sup>			
2	1250 V a.c. (IEC) 1300 V a.c. (UL)	250	6500	38,500	51,500	65	170M5388	170M5438		170M5588	
		280	9350	55,500	74,500	70	170M5389	170M5439		170M5589	
		315	13,000	77,500	105,000	75	170M5390	170M5440		170M5590	
		350	16,500	97,500	135,000	80	170M5391	170M5441		170M5591	
		400	23,000	140,000	180,000	85	170M5392	170M5442		170M5592	
		450	34,000	205,000	270,000	90	170M5393	170M5443		170M5593	
		500	48,000	285,000	380,000	95	170M5394	170M5444	170M5494	170M5594	170M5644
		550	62,000	370,000	495,000	100	170M5395	170M5445	170M5495	170M5595	170M5645
		630	115,000	575,000	730,000	120	170M5396 <sup>4</sup>	170M5446	170M5496	170M5596 <sup>4</sup>	170M5646
		700	160,000	795,000	1,050,000	125	170M5397 <sup>5</sup>	170M5447 <sup>7</sup>	170M5497	170M5597 <sup>5</sup>	170M5647
		800	245,000	1,200,000	1,550,000	130	170M5398 <sup>5</sup>	170M5448 <sup>8</sup>	170M5498	170M5598 <sup>5</sup>	170M5648
900	360,000	1,750,000	N/A	135			170M5499 <sup>9</sup>		170M5649 <sup>9</sup>		
1000	480,000	2,350,000	N/A	145			170M5500 <sup>9</sup>		170M5650 <sup>9</sup>		
3	1250 V a.c. (IEC) 1300 V a.c. (UL)	315	9500	58,000	77,500	85	170M6338 <sup>8</sup>	170M6538 <sup>8</sup>		170M6588	
		350	13,500	81,500	110,000	90	170M6339 <sup>8</sup>	170M6539 <sup>8</sup>		170M6589	
		400	19,500	120,000	160,000	95	170M6340 <sup>8</sup>	170M6540 <sup>8</sup>		170M6590	
		450	31,000	185,000	245,000	100	170M6341 <sup>8</sup>	170M6541 <sup>8</sup>		170M6591	
		500	39,000	235,000	310,000	105	170M6342 <sup>8</sup>	170M6542 <sup>8</sup>		170M6592	
		550	55,000	325,000	435,000	110	170M6343 <sup>8</sup>	170M6543 <sup>8</sup>		170M6593	
		630	83,500	495,000	665,000	115	170M6344 <sup>8</sup>	170M6544 <sup>8</sup>	170M6494 <sup>6</sup>	170M6594	170M6644
		700	115,000	705,000	940,000	120	170M6345	170M6545 <sup>6</sup>	170M6495 <sup>6</sup>	170M6595	170M6645 <sup>6</sup>
		800	205,000	995,000	1,300,000	125	170M6346 <sup>4</sup>	170M6546 <sup>6</sup>	170M6496 <sup>12</sup>	170M6596 <sup>4</sup>	170M6646 <sup>12</sup>
		900	305,000	1,500,000	1,900,000	130	170M6347 <sup>5</sup>	170M6547 <sup>10</sup>	170M6497 <sup>12</sup>	170M6597 <sup>5</sup>	170M6647 <sup>12</sup>
		1000	450,000	2,150,000	2,750,000	135	170M6348 <sup>5</sup>	170M6548 <sup>10</sup>	170M6498 <sup>12</sup>	170M6598 <sup>5</sup>	170M6648 <sup>12</sup>
		1100	575,000	2,800,000	3,600,000	160	170M6349 <sup>5</sup>	170M6549 <sup>11</sup>	170M6499 <sup>12</sup>	170M6599 <sup>5</sup>	170M6649 <sup>12</sup>
		1250	810,000	3,950,000	N/A	170			170M6500 <sup>13</sup>		170M6650 <sup>4</sup>
1400	1,250,000	6,000,000	N/A	175			170M6501 <sup>13</sup>		170M6651 <sup>4</sup>		

<sup>1</sup> Rated voltage 1100 V a.c. (IEC), 1000 V a.c. (UL).

<sup>2</sup> Rated voltage 1000 V a.c. (IEC and UL).

<sup>3</sup> Rated voltage 1100 V a.c. (IEC and UL).

<sup>4</sup> Rated voltage (IEC) 1100 V a.c.

<sup>5</sup> Rated voltage (IEC) 1000 V a.c.

<sup>6</sup> Rated voltage 900 V d.c. 8XIn 90 kA

<sup>7</sup> Rated voltage 1100 V a.c. (IEC), 1000 V a.c. (UL), and 1000 V d.c. 8XIn 70 kA

<sup>8</sup> Rated voltage 1000 V a.c. (IEC and UL), and 1000 V d.c. 8XIn 70 kA

<sup>9</sup> Rated voltage 1100 V a.c. (IEC and UL), and 900 V d.c. 9.5XIn 80 kA

<sup>10</sup> Rated voltage 1100 V a.c. (IEC), 1000 V a.c. (UL), and 900 V d.c. 8XIn 90 kA

<sup>11</sup> Rated voltage 1000 V a.c. (IEC and UL), and 900 V d.c. 8XIn 90 kA

<sup>12</sup> Rated voltage 1000 V d.c. 10XIn 91 kA

<sup>13</sup> Rated voltage 1100 V a.c. (IEC and UL), and 900 V d.c. 12XIn 90 kA

Data sheets: 170K6630 (Size 1\*), 170K6632 (Size 1), 170K6634 (Size 2), 170K6636 (Size 3)

**170M - Sizes 1\* to 3, Flush end contact, 1250 V a.c. (IEC), 1300 V a.c. (UL), 50 A to 1400 A**

Time-current curve - Size 1\*, 50 A to 400 A

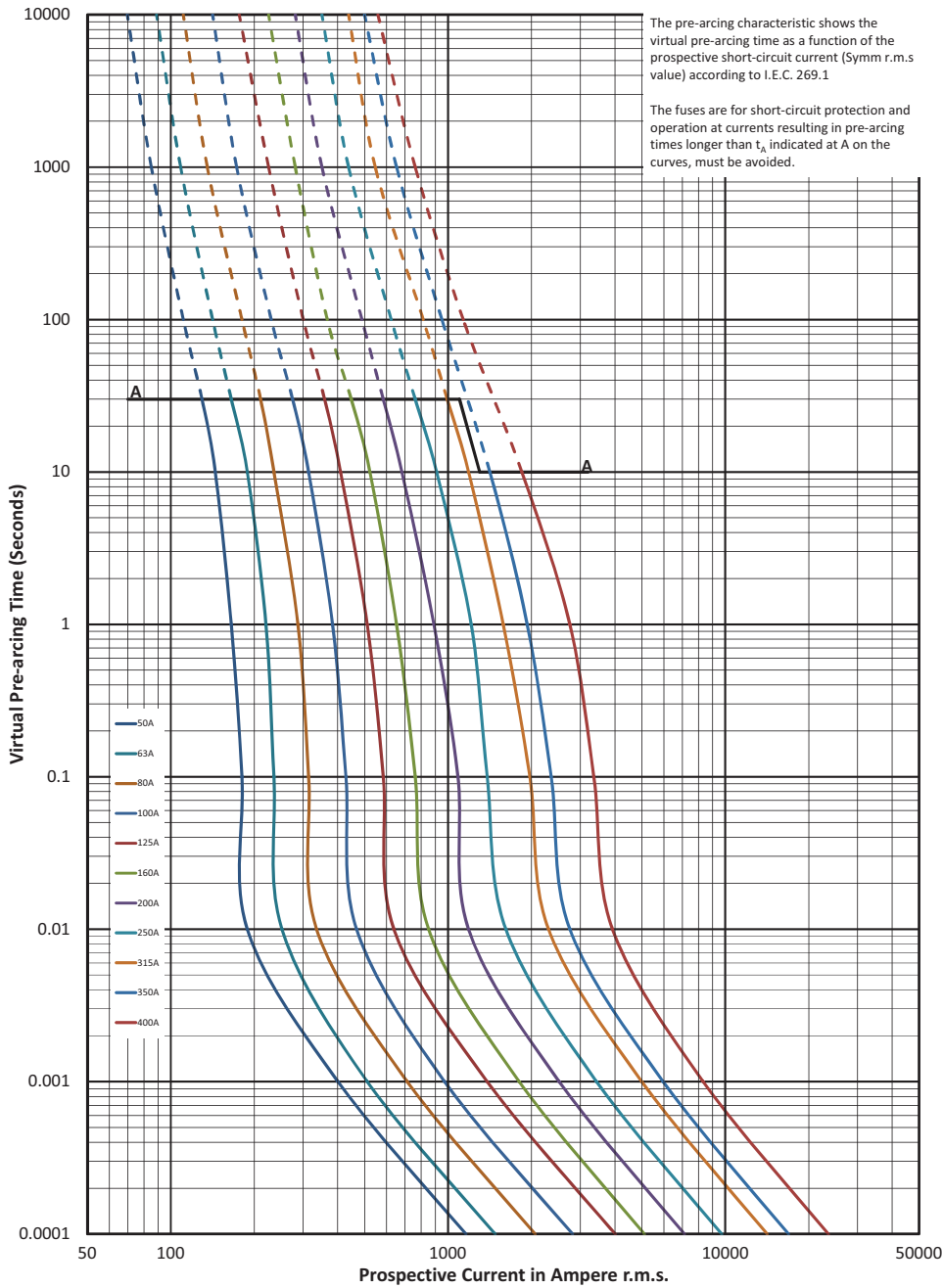

$K_b = 1$   $N = 1,6$

# Square body fuse links

## 170M - Sizes 1\* to 3, Flush end contact, 1250 V a.c. (IEC), 1300 V a.c. (UL), 50 A to 1400 A

### Cut-off curve - Size 1\*, 50 A to 400 A

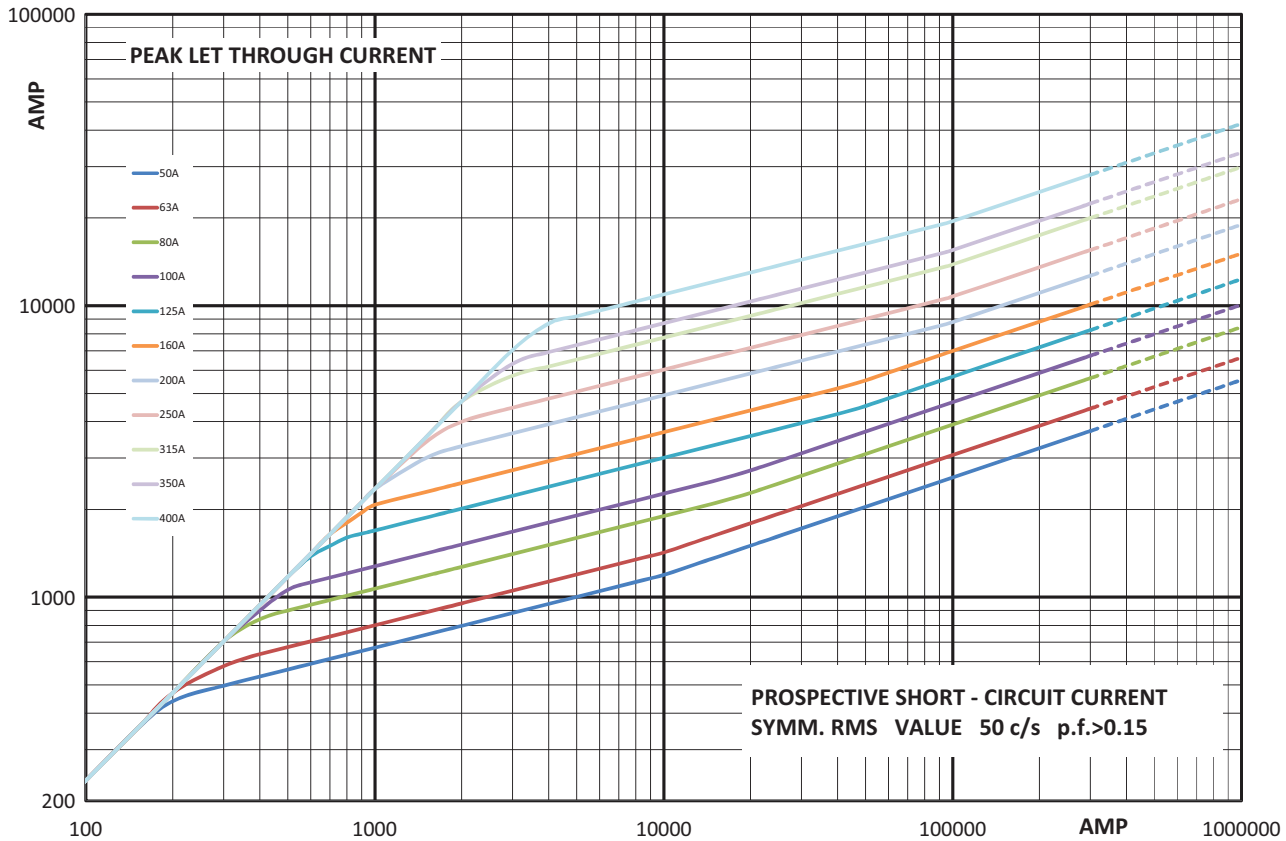

### Total clearing I<sup>2</sup>t

The total clearing I<sup>2</sup>t at rated voltage and at a power factor of 15 percent are given in the electrical characteristics. For other voltages, the clearing I<sup>2</sup>t is found by multiplying by correction factor, K, given as a function of applied working voltage, E<sub>g</sub>, (RMS).

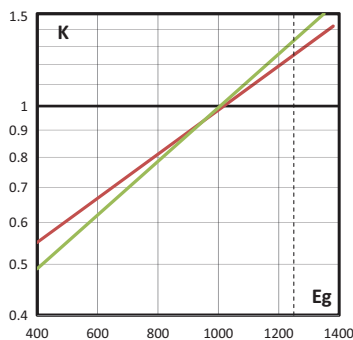

B: fuses ≤ 350 A  
C: fuses ≥ 400 A

### Arc voltage

This curve gives the peak arc voltage, U<sub>L</sub>, which may appear across the fuse during its operation as a function of the applied working voltage, E<sub>g</sub>, (RMS) at a power factor of 15 percent.

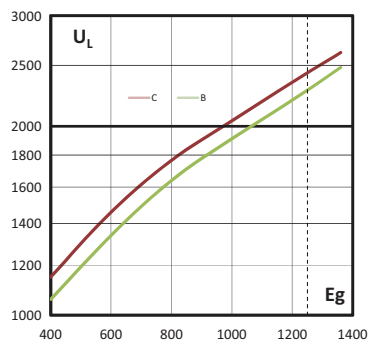

B: fuses ≤ 350 A  
C: fuses ≥ 400 A

### Watts losses

Watts loss at rated current is given in the electrical characteristics. The curve allows the calculation of the watts losses at load currents lower than the rated current. The correction factor, K<sub>p</sub>, is given as a function of the RMS load current, I<sub>b</sub>, in percent of the rated current.

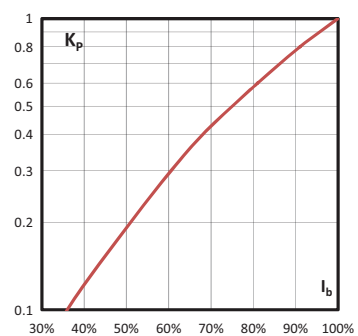

**170M** - Sizes 1\* to 3, Flush end contact, 1250 V a.c. (IEC), 1300 V a.c. (UL), 50 A to 1400 A

Time-current curve - Size 1, 160 A to 630 A

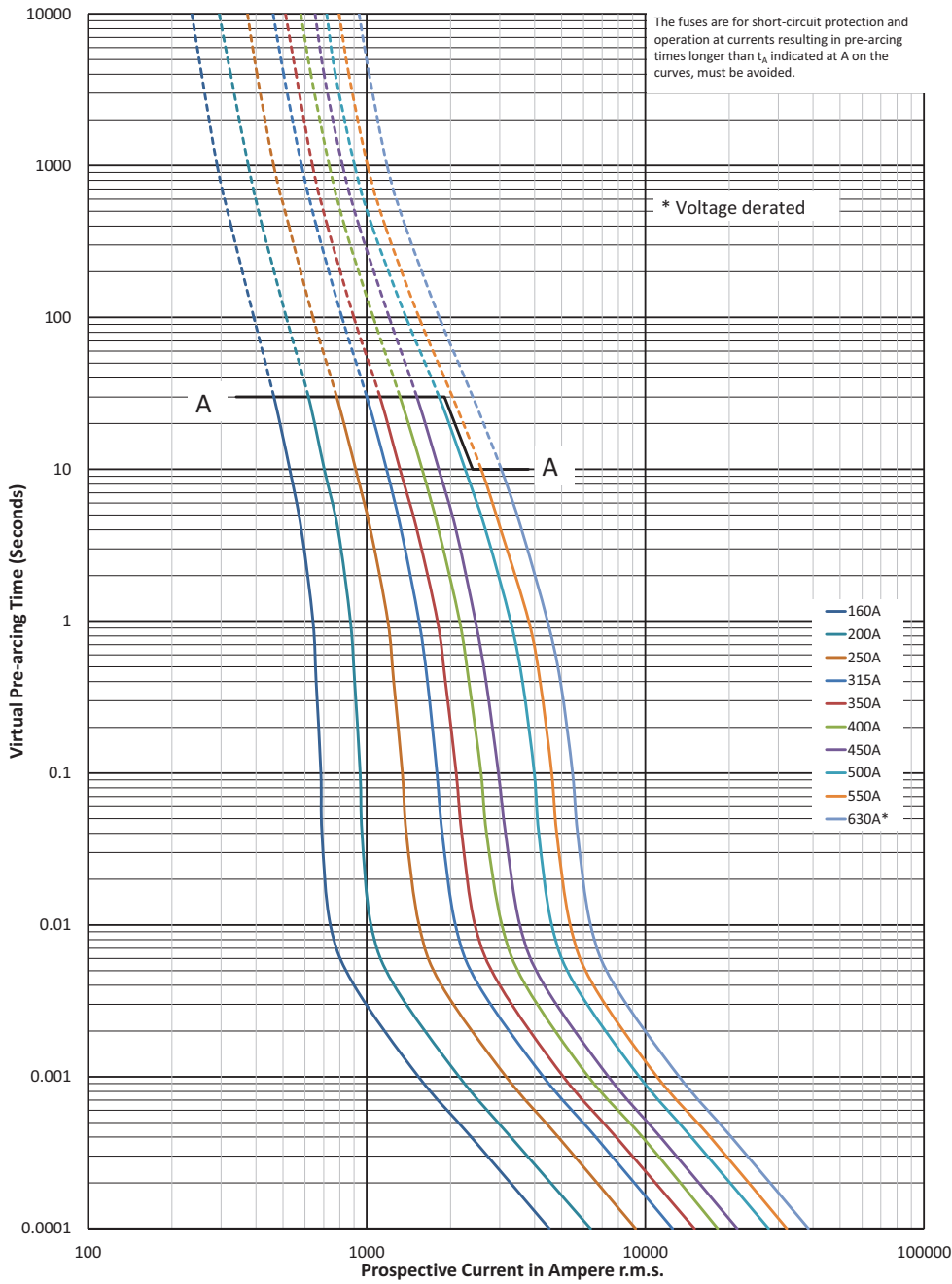

$K_b = 1$   $N = 1.6$

# Square body fuse links

## 170M - Sizes 1\* to 3, Flush end contact, 1250 V a.c. (IEC), 1300 V a.c. (UL), 50 A to 1400 A

### Cut-off curve - Size 1, 160 A to 630 A

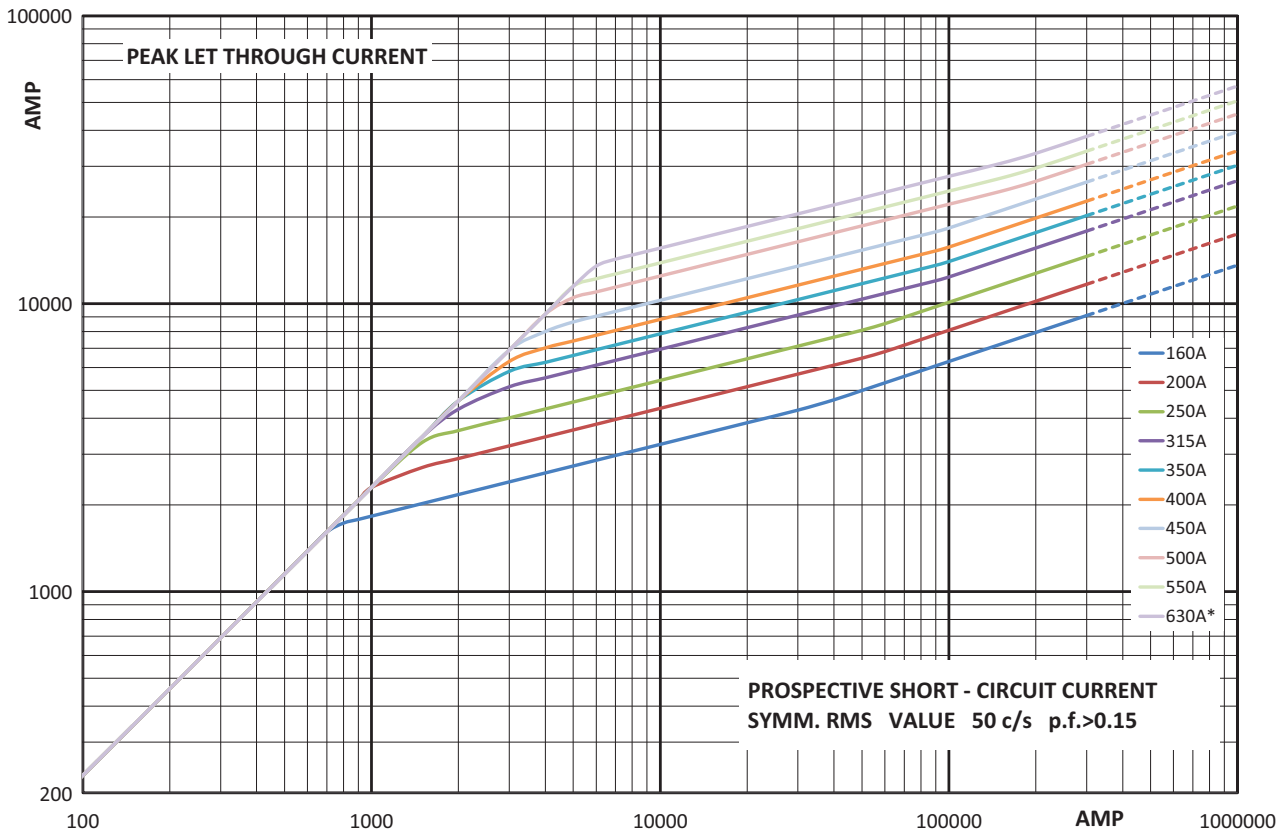

### Total clearing $I^2t$

The total clearing  $I^2t$  at rated voltage and at a power factor of 15 percent are given in the electrical characteristics. For other voltages, the clearing  $I^2t$  is found by multiplying by correction factor,  $K$ , given as a function of applied working voltage,  $E_g$ , (RMS).

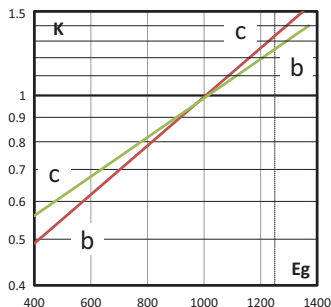

B: fuses  $\leq$  450 A  
C: fuses  $\geq$  500 A

### Arc voltage

This curve gives the peak arc voltage,  $U_L$ , which may appear across the fuse during its operation as a function of the applied working voltage,  $E_g$ , (RMS) at a power factor of 15 percent.

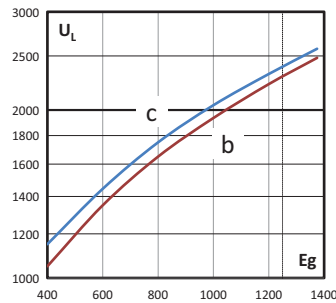

B: fuses  $\leq$  450 A  
C: fuses  $\geq$  500 A

### Watts losses

Watts loss at rated current is given in the electrical characteristics. The curve allows the calculation of the watts losses at load currents lower than the rated current. The correction factor,  $K_p$ , is given as a function of the RMS load current,  $I_b$ , in percent of the rated current.

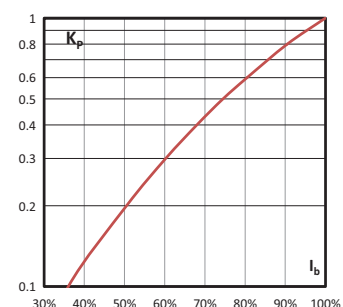

**170M** - Sizes 1\* to 3, Flush end contact, 1250 V a.c. (IEC), 1300 V a.c. (UL), 50 A to 1400 A

Time-current curve - Size 2, 250 A to 1000 A

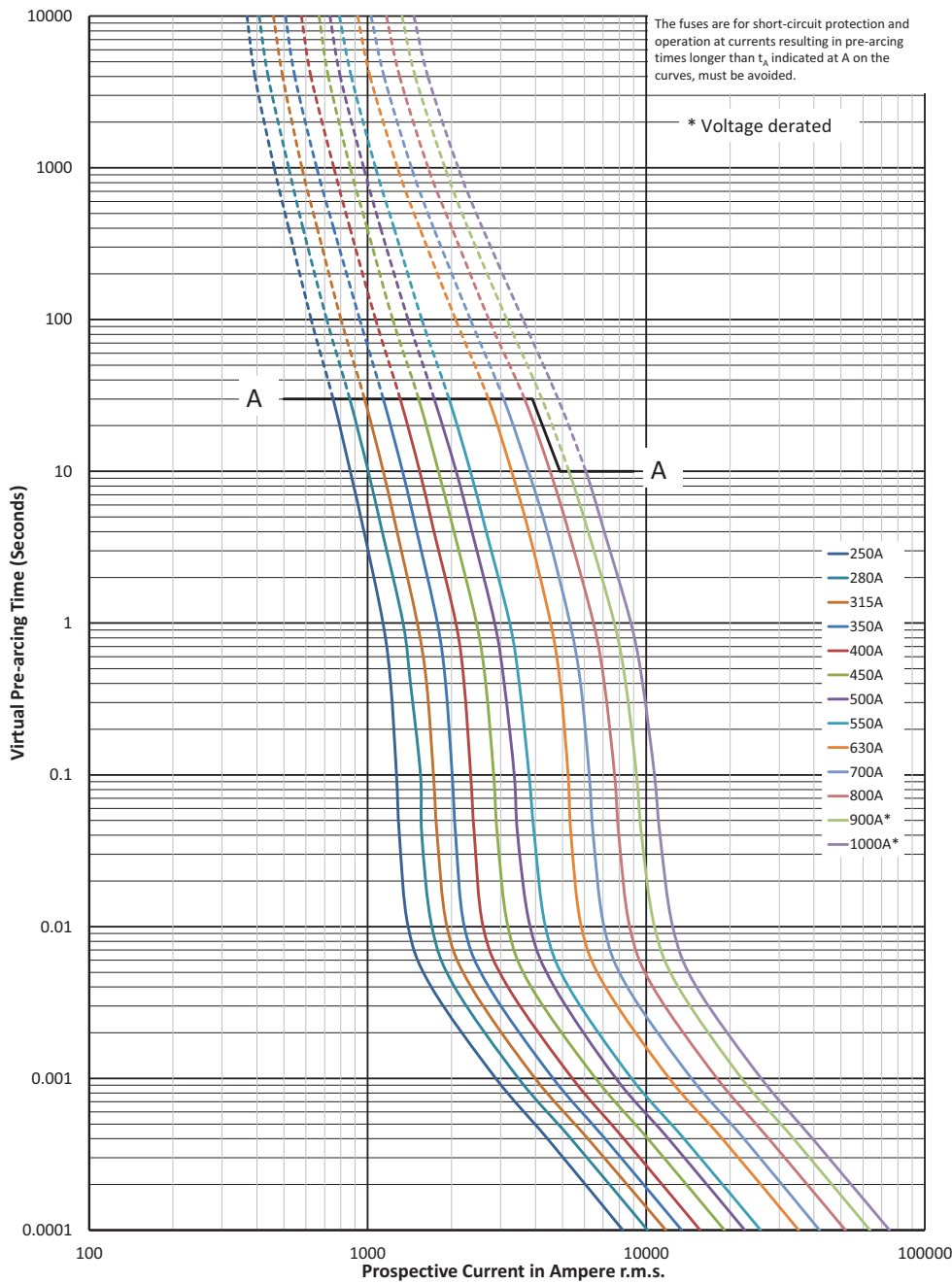

# Square body fuse links

**170M** - Sizes 1\* to 3, Flush end contact, 1250 V a.c. (IEC), 1300 V a.c. (UL), 50 A to 1400 A

Cut-off curve - Size 2, 250 A to 1000 A

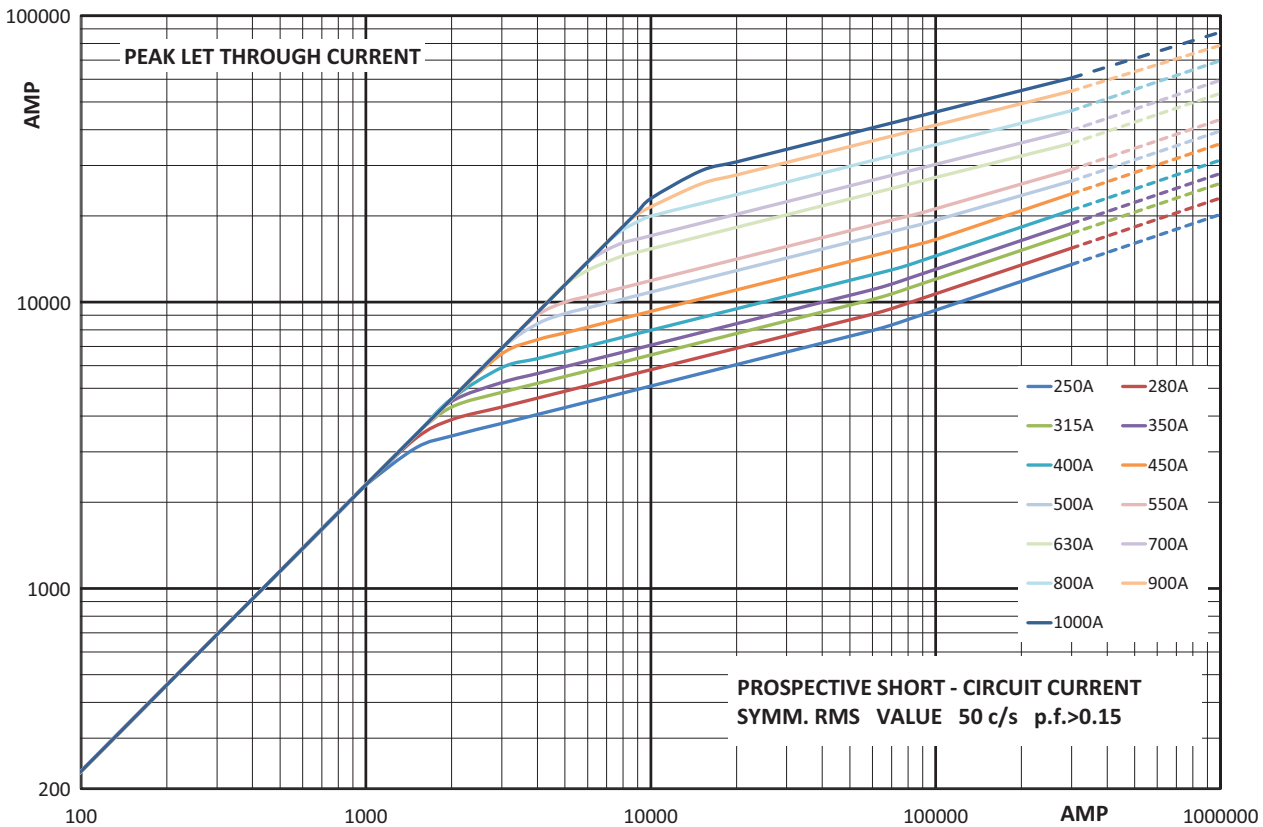

## Total clearing $I^2t$

The total clearing  $I^2t$  at rated voltage and at a power factor of 15 percent are given in the electrical characteristics. For other voltages, the clearing  $I^2t$  is found by multiplying by correction factor,  $K$ , given as a function of applied working voltage,  $E_g$ , (RMS).

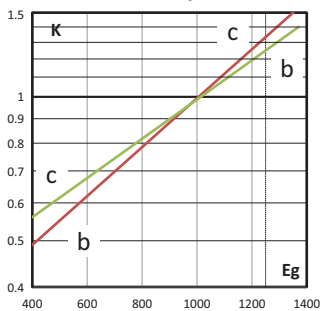

B: fuses ≤ 550 A  
C: fuses ≥ 630 A

## Arc voltage

This curve gives the peak arc voltage,  $U_L$ , which may appear across the fuse during its operation as a function of the applied working voltage,  $E_g$ , (RMS) at a power factor of 15 percent.

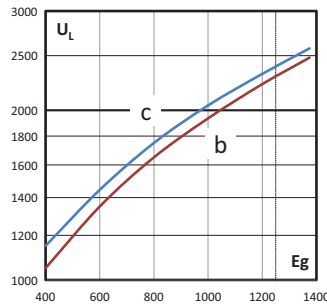

B: fuses ≤ 550 A  
C: fuses ≥ 630 A

## Watts losses

Watts loss at rated current is given in the electrical characteristics. The curve allows the calculation of the watts losses at load currents lower than the rated current. The correction factor,  $K_p$ , is given as a function of the RMS load current,  $I_b$ , in percent of the rated current.

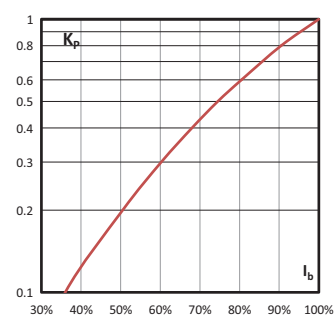



**170M** - Sizes 1\* to 3, Flush end contact, 1250 V a.c. (IEC), 1300 V a.c. (UL), 50 A to 1400 A

Time-current curve - Size 3, 315 A to 1400 A

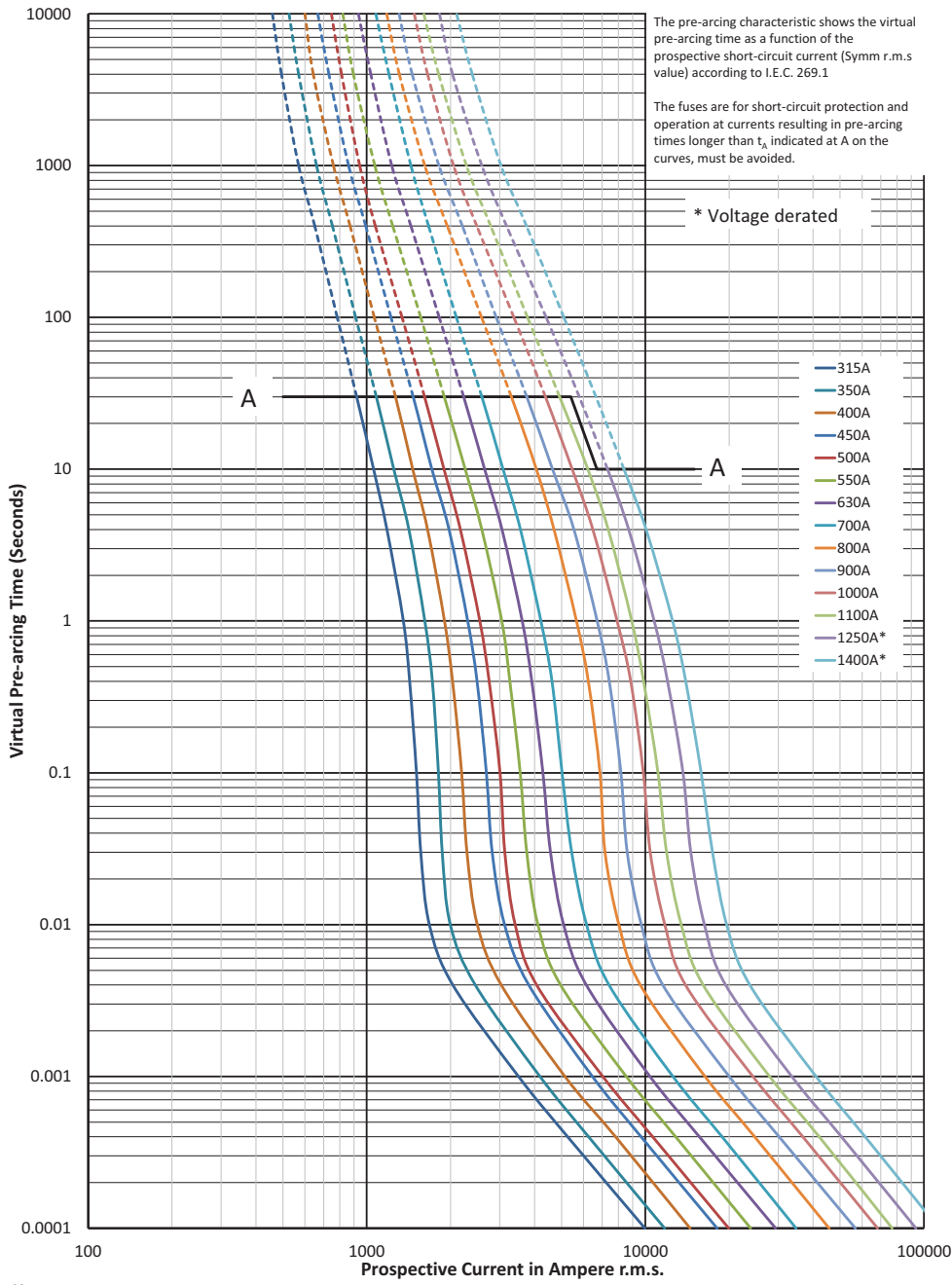

$K_b = 1$     $N = 1.6$

# Square body fuse links

## 170M - Sizes 1\* to 3, Flush end contact, 1250 V a.c. (IEC), 1300 V a.c. (UL), 50 A to 1400 A

### Cut-off curve - Size 3, 315 A to 1400 A

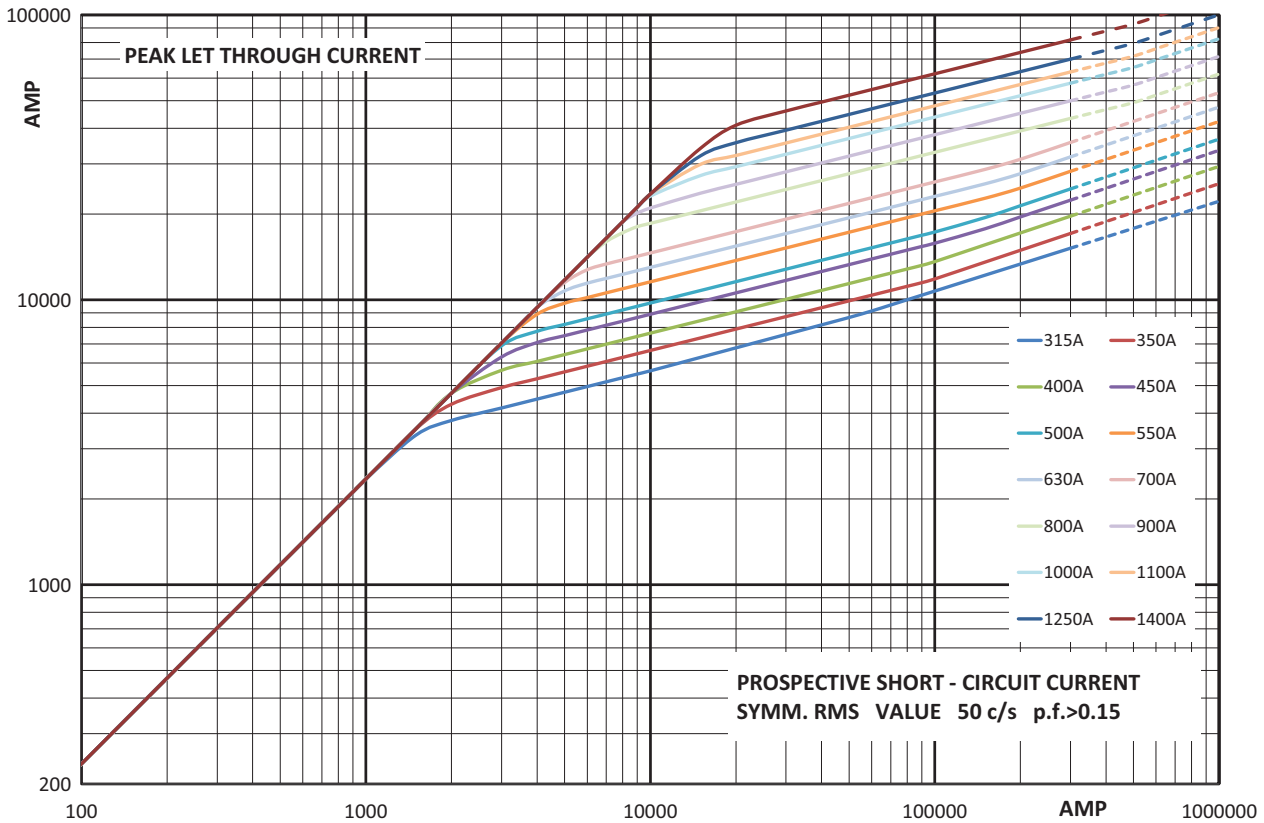

### Total clearing $I^2t$

The total clearing  $I^2t$  at rated voltage and at a power factor of 15 percent are given in the electrical characteristics. For other voltages, the clearing  $I^2t$  is found by multiplying by correction factor,  $K$ , given as a function of applied working voltage,  $E_g$ , (RMS).

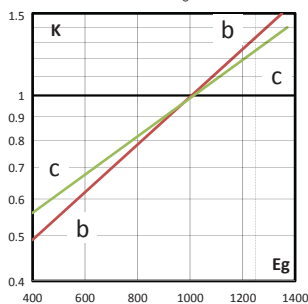

B: fuses  $\leq 700$  A  
C: fuses  $\geq 800$  A

### Arc voltage

This curve gives the peak arc voltage,  $U_L$ , which may appear across the fuse during its operation as a function of the applied working voltage,  $E_g$ , (RMS) at a power factor of 15 percent.

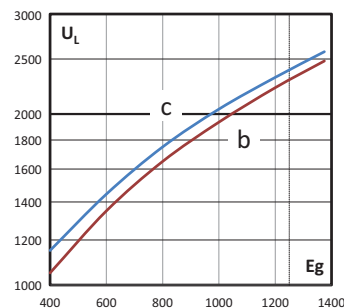

B: fuses  $\leq 700$  A  
C: fuses  $\geq 800$  A

### Watts losses

Watts loss at rated current is given in the electrical characteristics. The curve allows the calculation of the watts losses at load currents lower than the rated current. The correction factor,  $K_p$ , is given as a function of the RMS load current,  $I_b$ , in percent of the rated current.

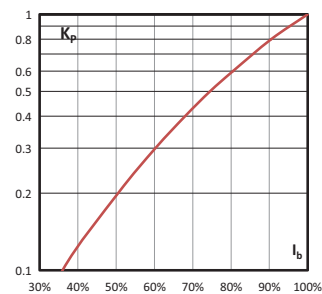

## 170M - Size 4, Flush end contact, 690 V a.c. (IEC), 700 V a.c. (UL), 1000 A to 4000 A

### Specifications

#### Description

Square body, flush end contact, high speed fuse links, for the protection of power rectifiers.

#### Technical data

- Rated voltage:
  - 690 V a.c. (IEC) / 700 V a.c. (UL) 1000 A to 3500 A
  - 600 V a.c. (IEC and UL, 4000 A)
- Rated current: 1000 A to 4000 A
- Breaking capacity: 200 kA RMS Sym
- Operating class: aR



#### Standards / Agency information

CE, Designed and tested to IEC 60269 Part 4, UL Recognised

#### Catalogue numbers

Fuse link body size	Rated voltage	Rated current (Amps)	I <sup>2</sup> t (A <sup>2</sup> Sec)			Catalogue numbers				
			Pre-arcing	Clearing at 660 V a.c.	Watts loss (W)	-B/65 visual indicator	-BKN/65 Type K indicator	-G/65 visual indicator	-GKN/65 Type K indicator	
4	690 V a.c. (IEC) 700 V a.c. (UL)	1000	76,000	505,000	175	170M7058	170M7078	170M7098	170M7118	
		1250	145,000	965,000	195	170M7059	170M7079	170M7099	170M7119	
		1400	205,000	1,400,000	205	170M7060	170M7080	170M7100	170M7120	
		1600	305,000	2,050,000	220	170M7061	170M7081	170M7101	170M7121	
		1800	436,600	3,067,000	260	170M7340	-	-	-	
		2000	600,000	3,950,000	245	170M7062	170M7082	170M7102	170M7122	
		2200	805,000	5,350,000	255	170M7116	170M7114	170M7171	170M7173	
		2500	1,200,000	7,800,000	275	170M7063	170M7083	170M7103	170M7123	
		3000	2,000,000	13,500,000	305	170M7064	170M7084	170M7104	170M7124	
		3500	3,250,000	22,000,000	325	170M7065	170M7085	170M7105	170M7125	
		600 V a.c. (IEC & UL)	4000	4,700,000	28,000,000 <sup>1</sup>	355	170M7066	170M7086	170M7106	170M7126

<sup>1</sup> Clearing at 600 V a.c.

#### Dimensions (mm) -BKN/65 and -GKN/65

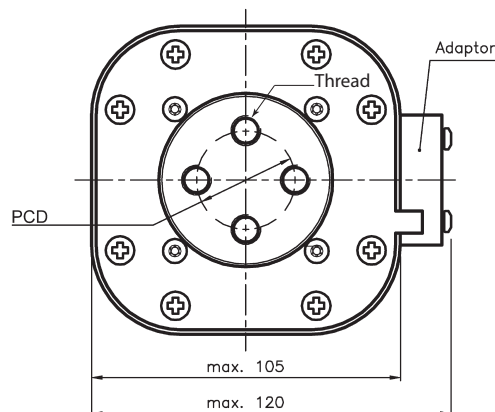
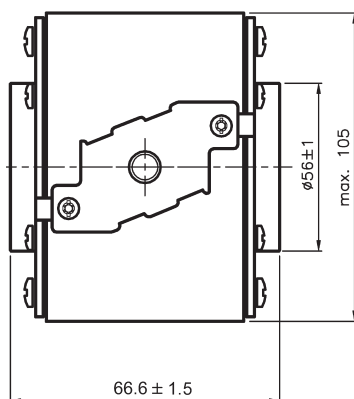

Type	PCD	Thread
-GKN/65	Ø 38.1	UNC ½" - 13
-BKN/65	Ø 33	M-10

# Square body fuse links

## 170M - Size 4, Flush end contact, 690 V a.c. (IEC), 700 V a.c. (UL), 1000 A to 4000 A

Dimensions (mm) -B/65 and -G/65

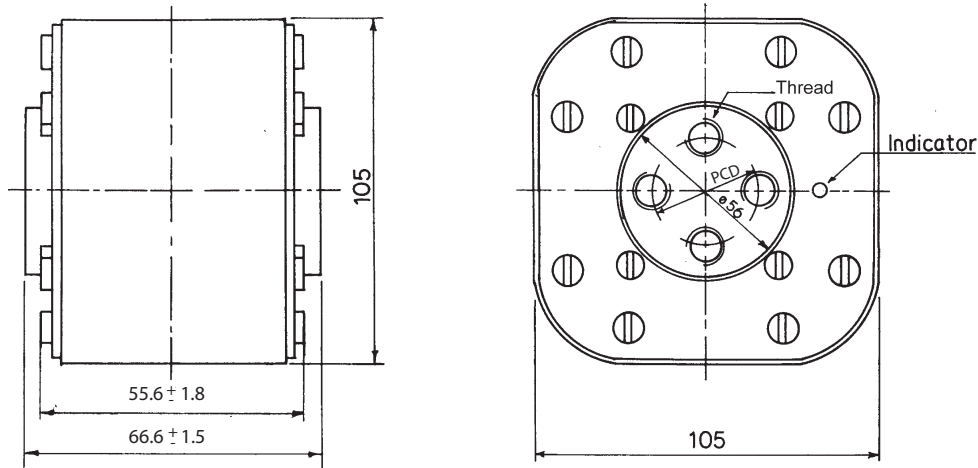

Type -B/65, -G/65

	PCD	Thread
-G/65	∅ 38.1	UNC 1/2" - 13
-B/65	∅ 33	M-10

### Time-current curve - 1000 A to 4000 A

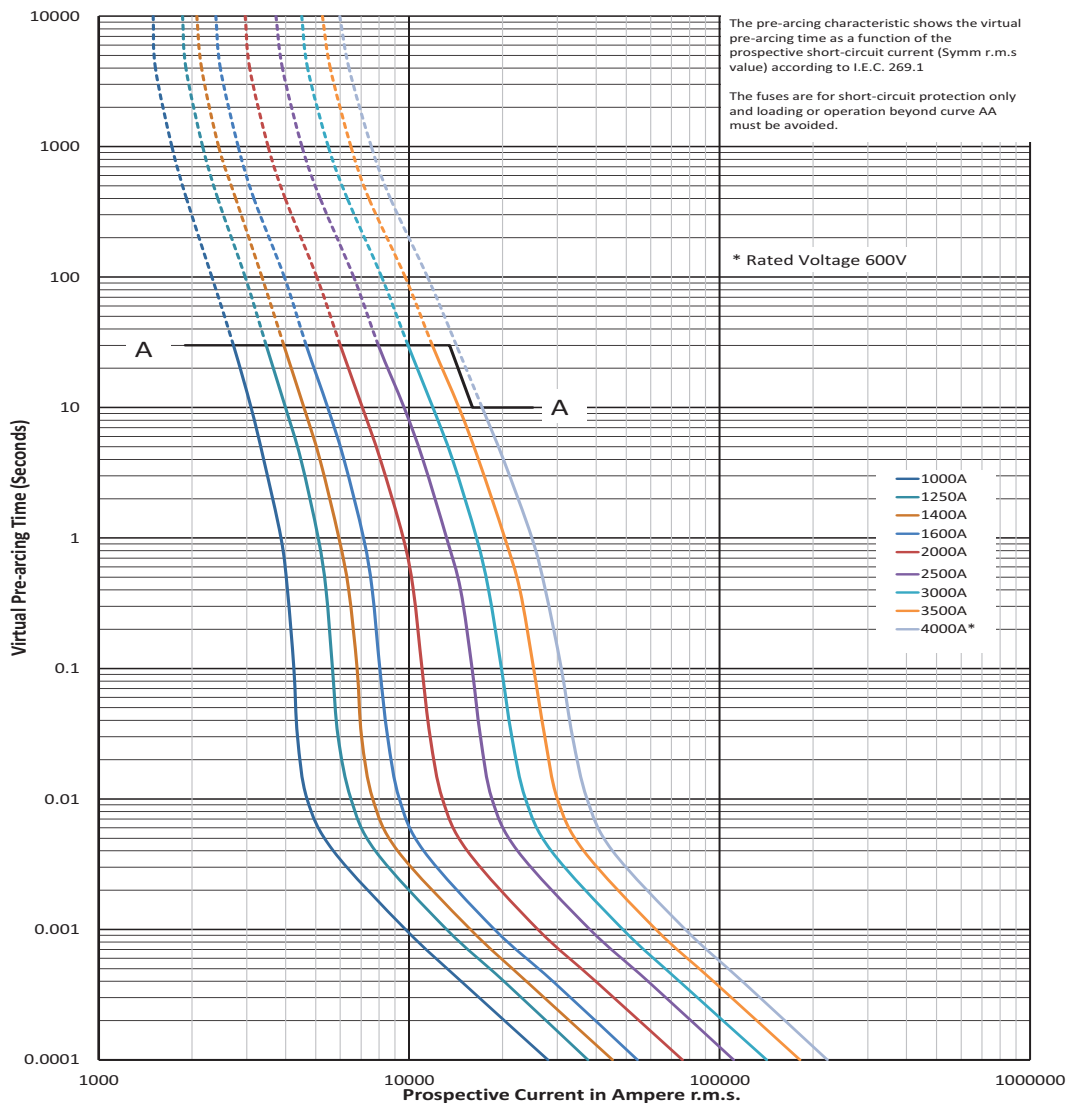

$K_b = 1 \quad N = 1.5$

Data sheet: 170K6328

**170M - Size 4, Flush end contact, 690 V a.c. (IEC), 700 V a.c. (UL), 1000 A to 4000 A**

**Cut-off curve - 1000 A to 4000 A**

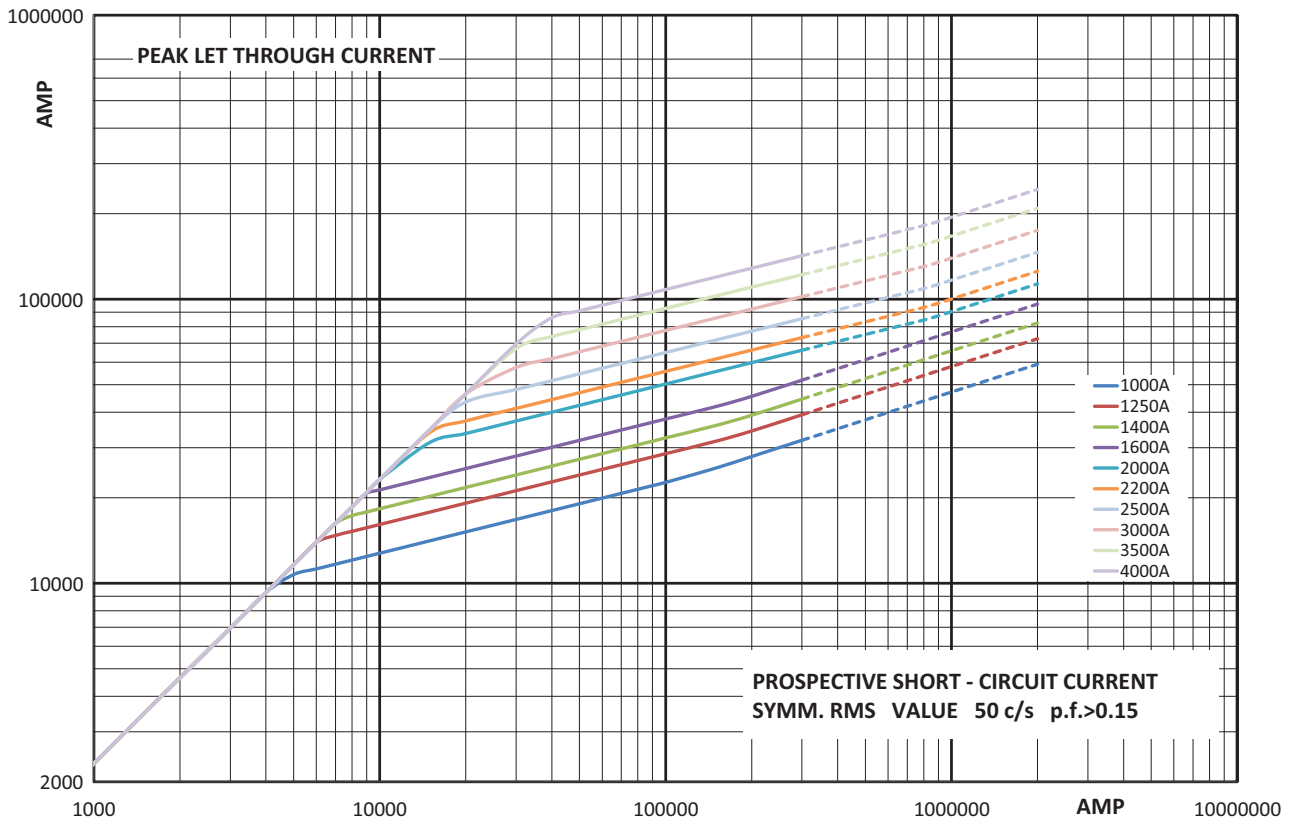

**Total clearing I<sup>2</sup>t**

The total clearing I<sup>2</sup>t at rated voltage and at a power factor of 15 percent are given in the electrical characteristics. For other voltages, the clearing I<sup>2</sup>t is found by multiplying by correction factor, K, given as a function of applied working voltage, E<sub>g</sub>, (RMS).

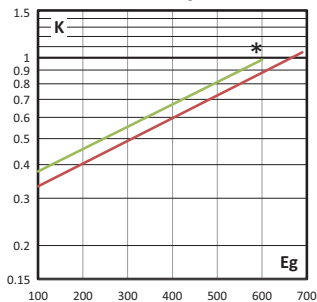

**Arc voltage**

This curve gives the peak arc voltage, U<sub>L</sub>, which may appear across the fuse during its operation as a function of the applied working voltage, E<sub>g</sub>, (RMS) at a power factor of 15 percent.

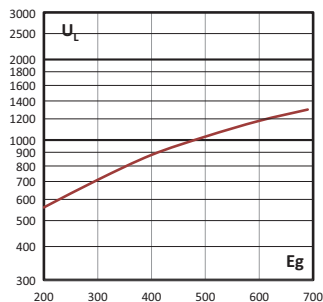

**Watts losses**

Watts loss at rated current is given in the electrical characteristics. The curve allows the calculation of the watts losses at load currents lower than the rated current. The correction factor, K<sub>p</sub>, is given as a function of the RMS load current, I<sub>b</sub>, in percent of the rated current.

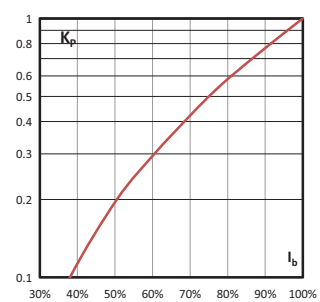

# Square body fuse links

## 170M - Size 4, Flush end contact, 1000 V a.c. (IEC), 1000 A to 3000 A

### Specifications

#### Description

Square body, flush end contact, high speed fuse links, for the protection of power rectifiers.

#### Technical data

- Rated voltage: 1000 V a.c. (IEC)
- Rated current: 1000 A to 3000 A
- Breaking capacity: 200 kA RMS Sym
- Operating class: aR

#### Standards / Agency information

CE, Designed and tested to IEC 60269 Part 4



#### Catalogue numbers

Fuse link body size	Rated voltage	Rated current (Amps)	I <sup>2</sup> t (A <sup>2</sup> Sec)			Catalogue numbers	
			Pre-arcing	Clearing at 1000 V a.c.	Watts loss (W)	-BKN/95 Type K indicator	-SBKN/90 Type K indicator
4	1000 V a.c.	1000	180,000	1,100,000	195		170M7542
		1100	250,000	1,500,000	200		170M7031
		1500	600,000	3,600,000	250	170M7636	170M7548
		1700	850,000	5,000,000	260	170M7639	170M7034
		1800	1,000,000	5,950,000	265	170M7661	170M7053
		2000	1,450,000	8,600,000	270	170M7963	170M7544
		2200	2,000,000	12,000,000	280	170M7090	170M7035
		2500	3,000,000	18,000,000	295	170M7640	170M7036
		2700	3,700,000	22,000,000	310	170M7658	170M7037
		3000	4,700,000	28,000,000	380	170M7962	170M7156

#### Dimensions (mm) - 4BKN/95

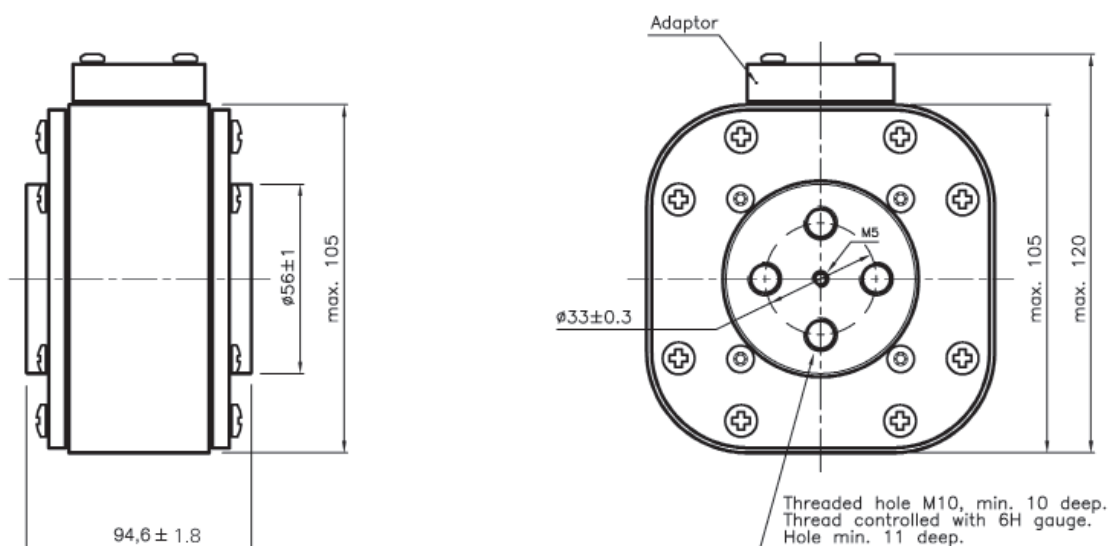

Data sheets: 170K8520 (1000 A to 1700 A, 2000 A to 2700 A, 170K8520-R (1800 and 3000 A)

**170M - Size 4, Flush end contact, 1000 V a.c. (IEC), 1000 A to 3000 A**

**Dimensions (mm) - 4SBKN/90**

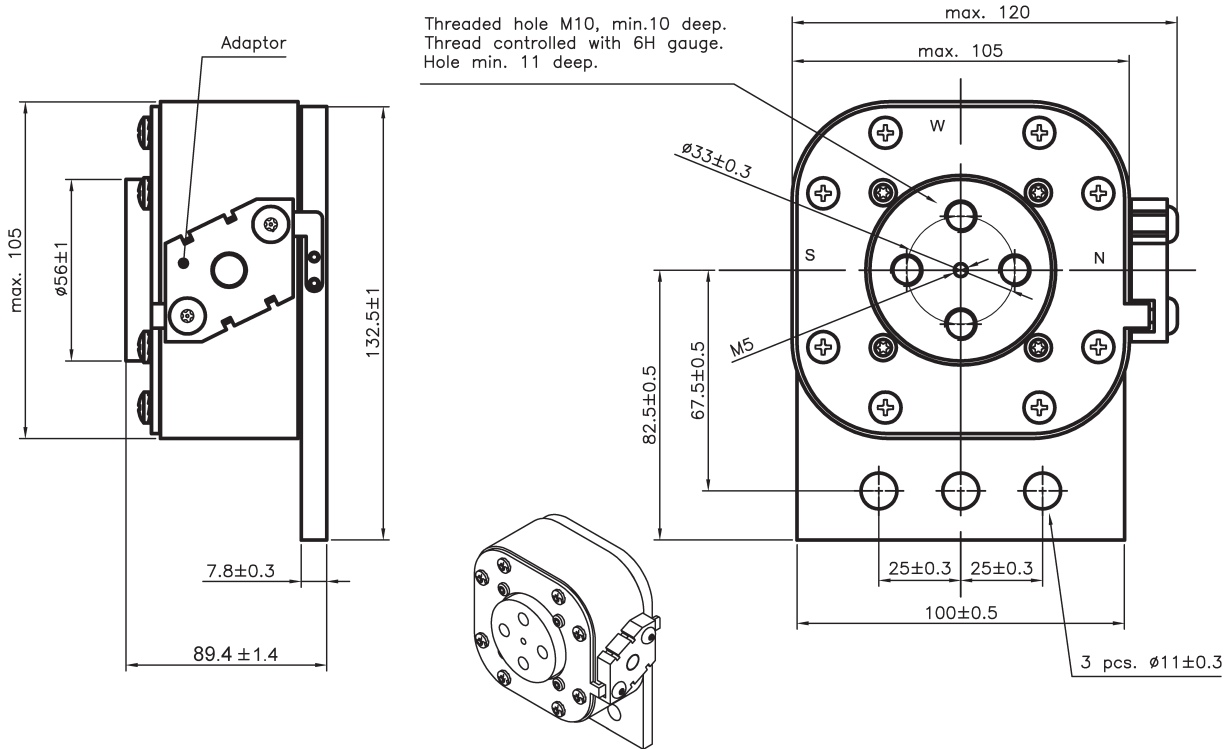

# Square body fuse links

## 170M - Size 4, Flush end contact, 1000 V a.c. (IEC), 1000 A to 3000 A

### Time-current curve - 1000 A to 2700 A

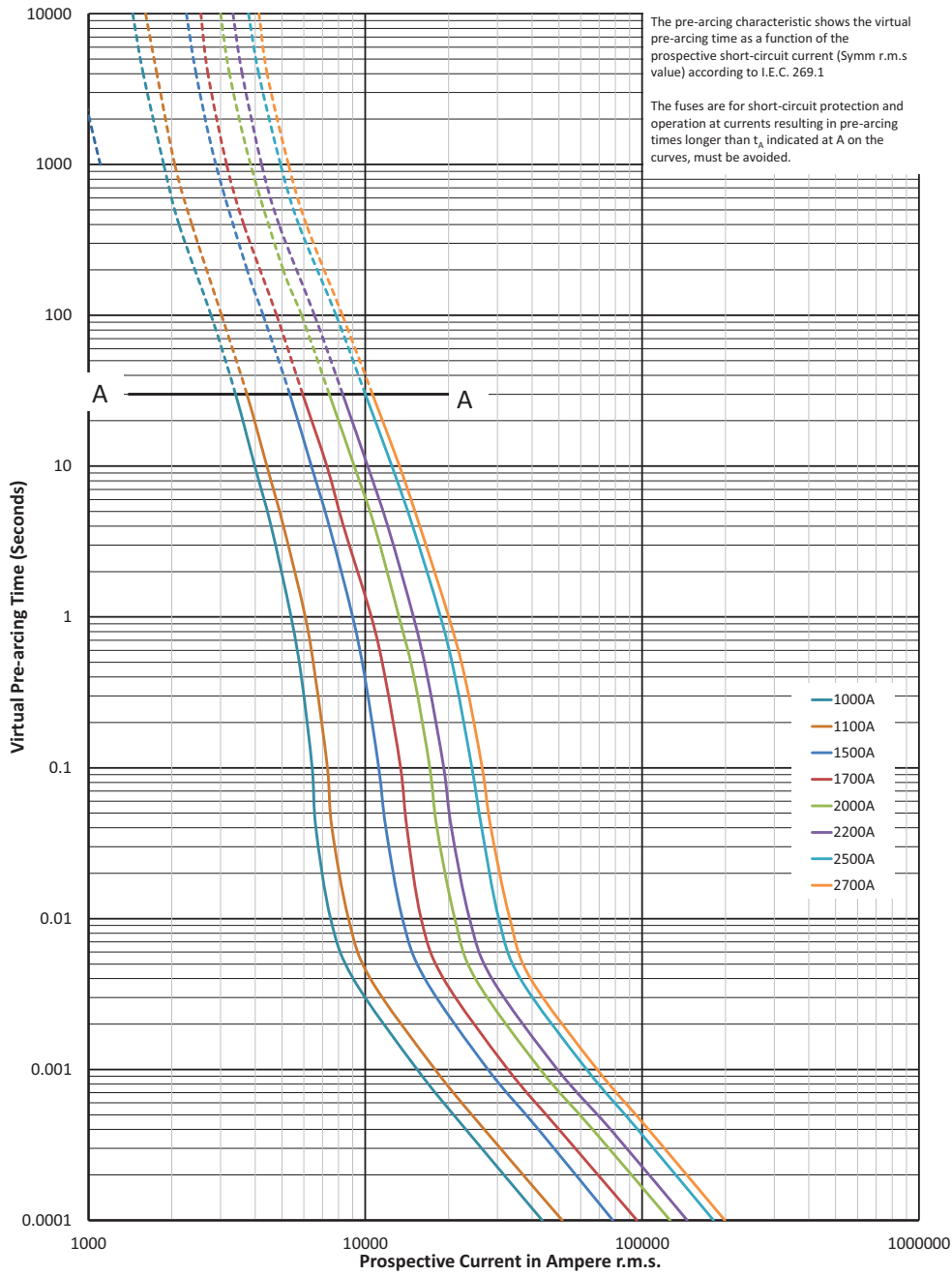



**170M - Size 4, Flush end contact, 1000 V a.c. (IEC), 1000 A to 3000 A**

**Cut-off curve - 1000 A to 2700 A**

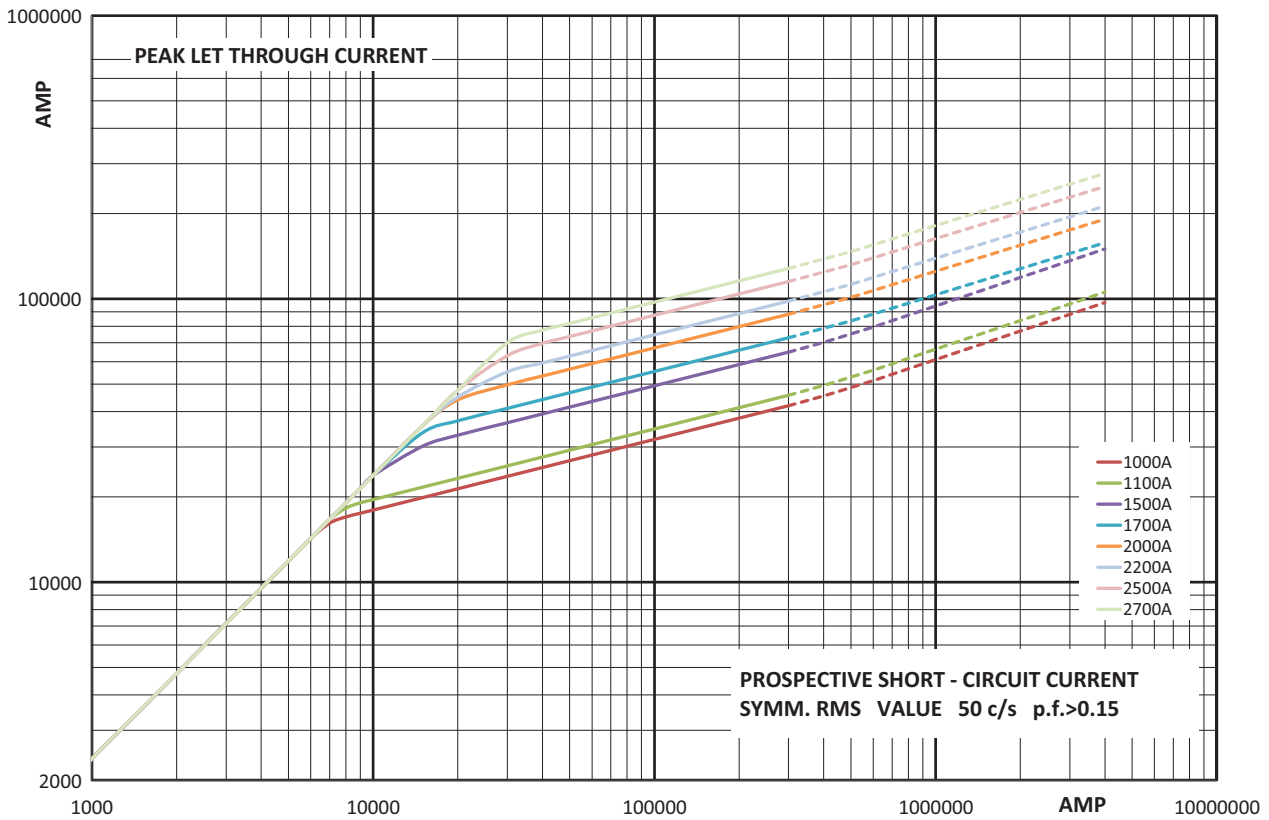

**Total clearing  $I^2t$**

The total clearing  $I^2t$  at rated voltage and at a power factor of 15 percent are given in the electrical characteristics. For other voltages, the clearing  $I^2t$  is found by multiplying by correction factor,  $K$ , given as a function of applied working voltage,  $E_g$ , (RMS).

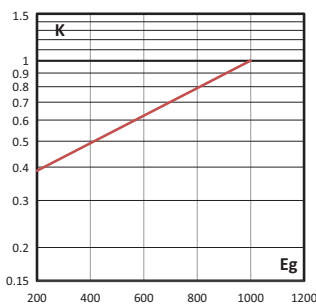

**Arc voltage**

This curve gives the peak arc voltage,  $U_L$ , which may appear across the fuse during its operation as a function of the applied working voltage,  $E_g$ , (RMS) at a power factor of 15 percent.

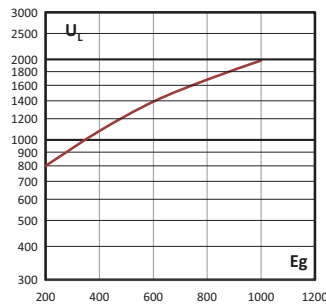

**Watts losses**

Watts loss at rated current is given in the electrical characteristics. The curve allows the calculation of the watts losses at load currents lower than the rated current. The correction factor,  $K_p$ , is given as a function of the RMS load current,  $I_b$ , in percent of the rated current.

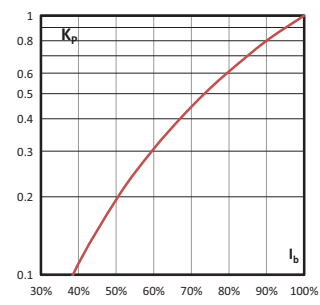

# Square body fuse links

## 170M - Size 4, Flush end contact, 1000 V a.c. (IEC), 1000 A to 3000 A

Time-current curve - 1800 A and 3000 A

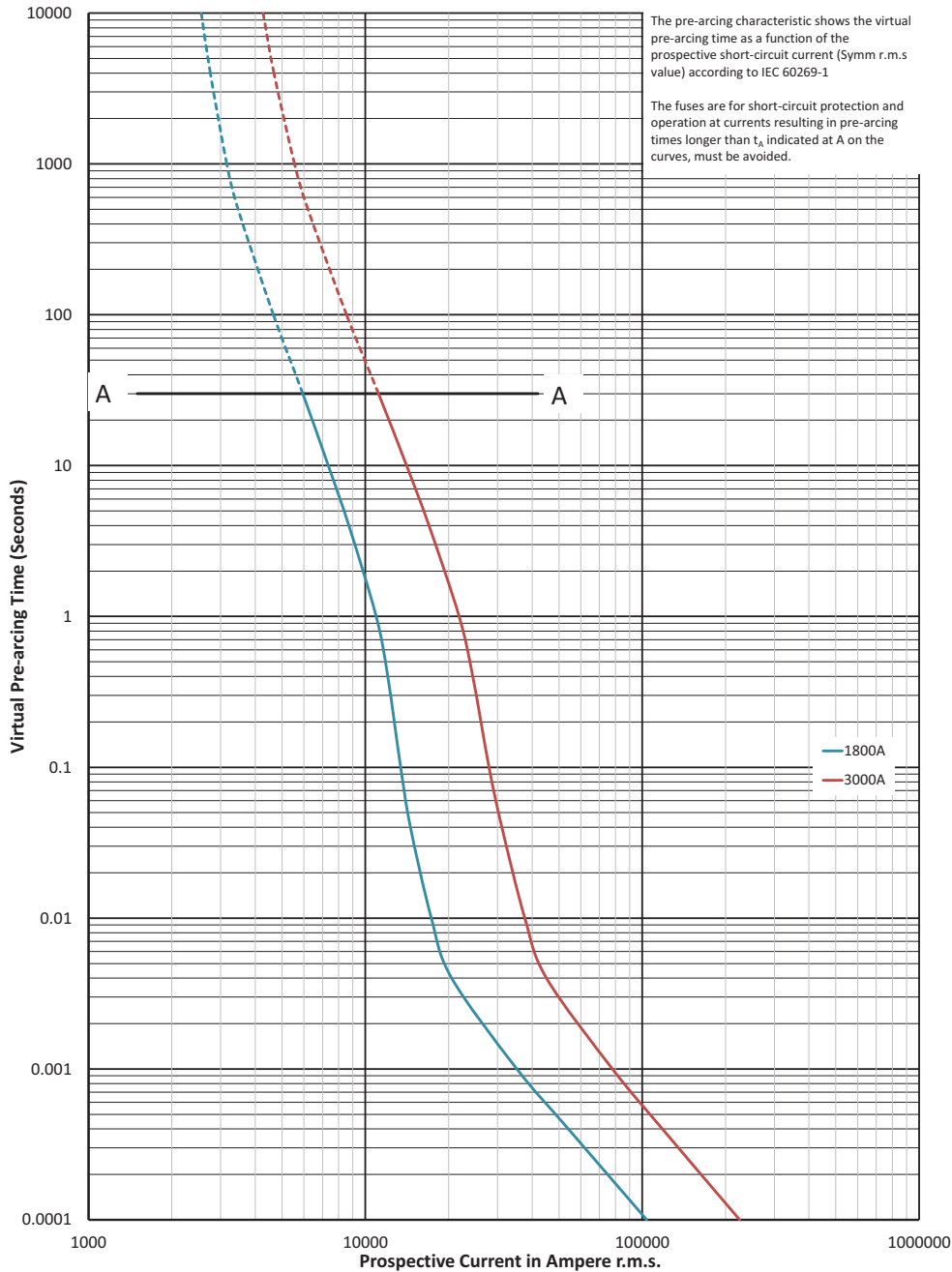

$K_b = 1$     $N = 1.6$

**170M - Size 4, Flush end contact, 1000 V a.c. (IEC), 1000 A to 3000 A**

Cut-off curve - 1800 A and 3000 A

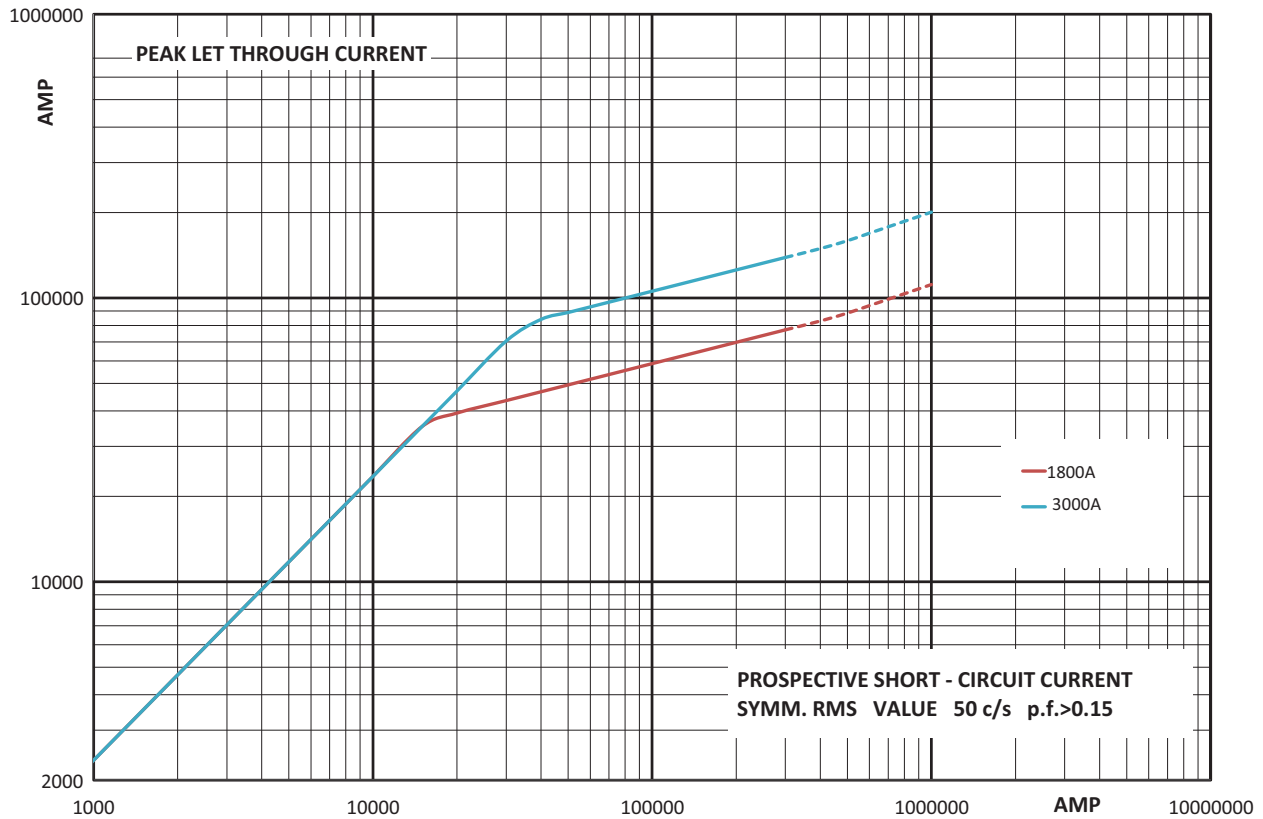

**Total clearing I<sup>2</sup>t**

The total clearing I<sup>2</sup>t at rated voltage and at a power factor of 15 percent are given in the electrical characteristics. For other voltages, the clearing I<sup>2</sup>t is found by multiplying by correction factor, K, given as a function of applied working voltage, E<sub>g</sub>, (RMS).

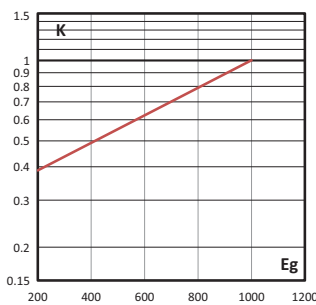

**Arc voltage**

This curve gives the peak arc voltage, U<sub>L</sub>, which may appear across the fuse during its operation as a function of the applied working voltage, E<sub>g</sub>, (RMS) at a power factor of 15 percent.

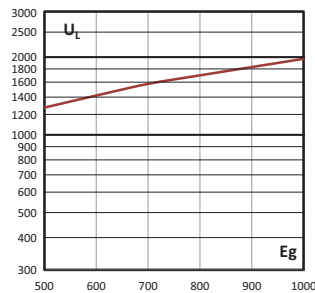

**Watts losses**

Watts loss at rated current is given in the electrical characteristics. The curve allows the calculation of the watts losses at load currents lower than the rated current. The correction factor, K<sub>p</sub>, is given as a function of the RMS load current, I<sub>b</sub>, in percent of the rated current.

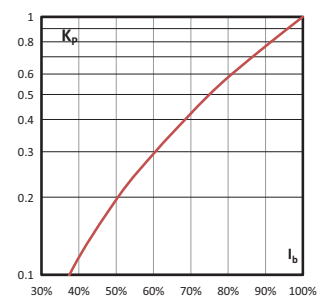

# Square body fuse links

## 170M - Size 4, Flush end contact, 1250 V a.c. (IEC), 800 A to 2500 A

### Specifications

#### Description

Square body, flush end contact, high speed fuse links, for the protection of power rectifiers.

#### Technical data

- Rated voltage:
  - 1250 V a.c. (IEC)
  - 1200 V d.c. (UL)
- Rated current: 800 A to 2500 A
- Operating class: aR



#### Standards / Agency information

CE, Designed and tested to IEC 60269 Part 4, UL

### Catalogue numbers

Fuse link body size	AC		DC		Rated current (Amps)	I <sup>2</sup> t (A <sup>2</sup> Sec)		Watts loss (W)	Catalogue numbers	
	Rated voltage	Breaking capacity	Rated voltage	Breaking capacity		Pre-arcing	Clearing at 1250 V a.c.		-BKN/110 Type K indicator	-SBKN/105 Type K indicator
4	1250 V a.c.	100 kA	1000 V d.c.	180 kA IR UL	800	145,000	905,000	195	170M7802	-
					1000	275,000	1,750,000	220	170M7803	-
					1200	495,000	3,100,000	240	170M7804	-
					1400	800,000	5,000,000	250	170M7217 <sup>1</sup>	170M7512
					1500	1,000,000	6,200,000	260	170M7597	170M7510
					1700	1,400,000	8,700,000	275	170M7676	170M7511
			1200 V d.c.	85 kA IR UL	1800	1,700,000	11,000,000	280	170M7532	170M7976
					2000	2,300,000	14,500,000	305	170M7633	170M7513
					2200	3,100,000	19,500,000	315	170M7592	170M7546
					2400	4,000,000	25,000,000	330	170M7107	170M7516
					2500	4,500,000	28,000,000	340	170M7595 <sup>2</sup>	170M7978

<sup>1</sup> 170M7217 rated 850 V d.c./1250 V a.c. (IEC), 1000 V d.c. 180 kA IR (UL), 1200 V d.c. 85 kA IR (UL)

<sup>2</sup> 170M7595 rated at 1200V d.c. 85kA only at 2ms time constant

**170M - Size 4, Flush end contact, 1250 V a.c. (IEC), 800 A to 2500 A**

**Dimensions (mm) - 4BKN/110**

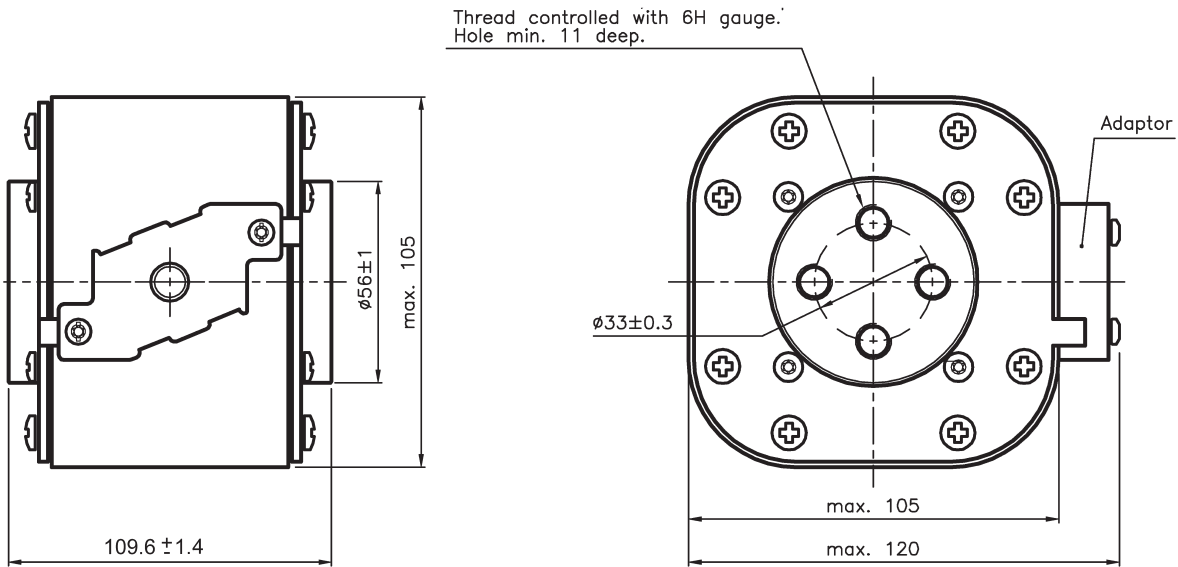

**Dimensions (mm) - 4SBKN/105**

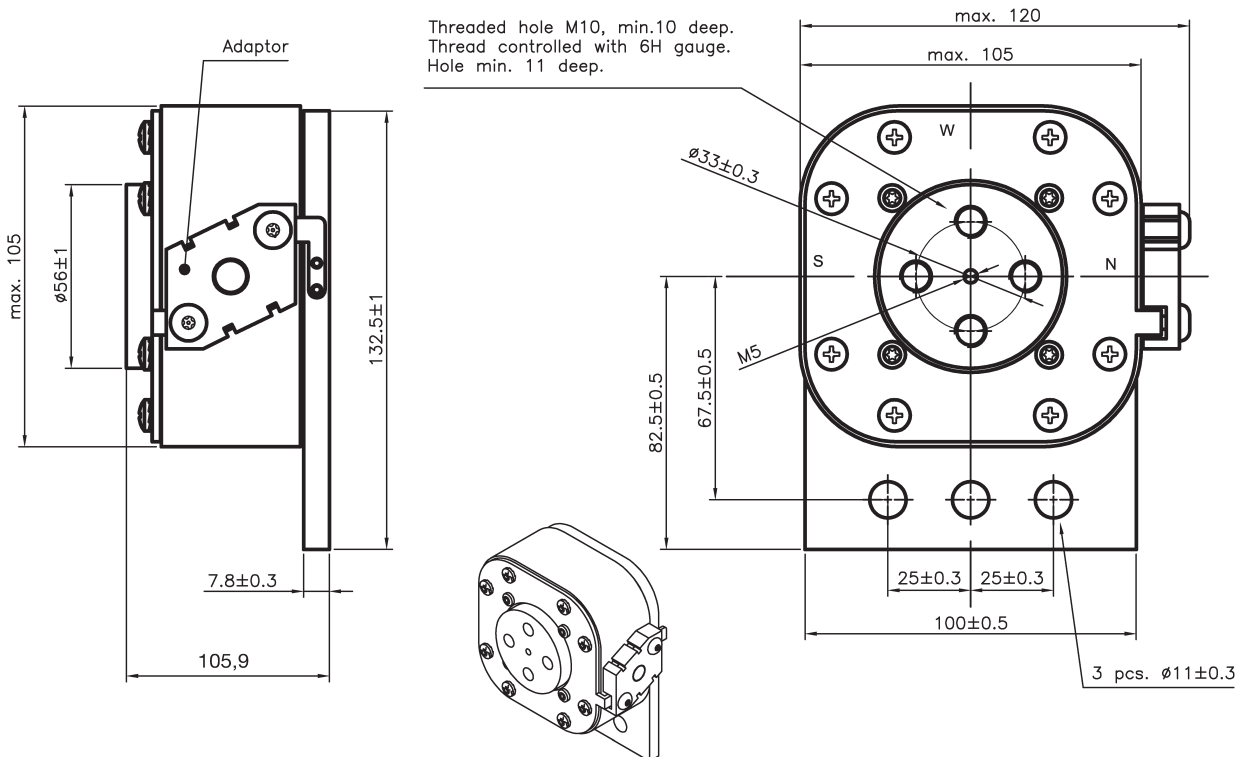

# Square body fuse links

## 170M - Size 4, Flush end contact, 1250 V a.c. (IEC), 800 A to 2500 A

### Time-current curve - 800 A to 2500 A

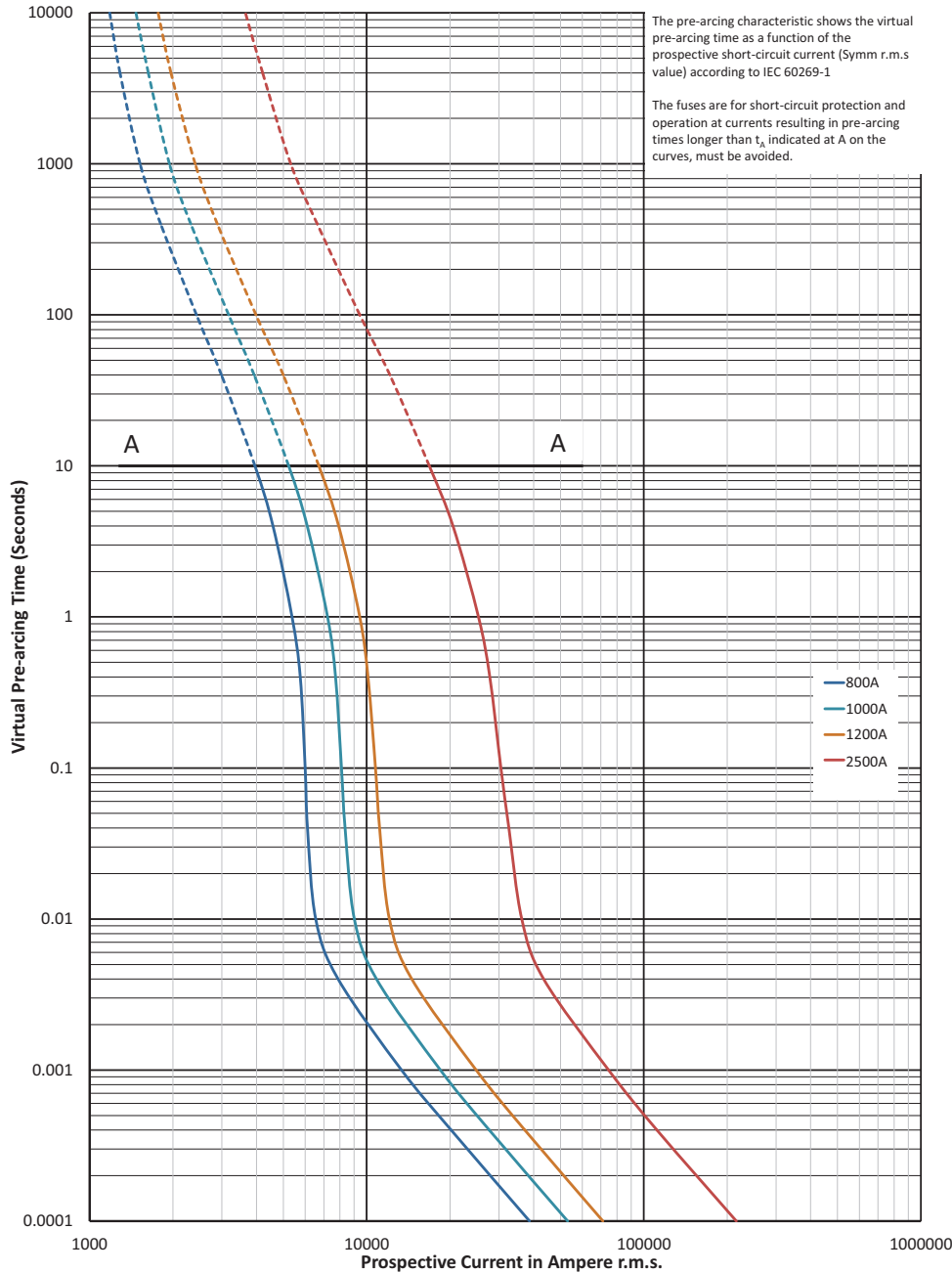

$K_b = 1$   $N = 1.7$

Data sheets: 170K6640 (1400 A to 2400 A), 170K6642 (800 A to 1200A and 2500 A)

**170M - Size 4, Flush end contact, 1250 V a.c. (IEC), 800 A to 2500 A**

**Cut-off curve - 800 A to 2500 A**

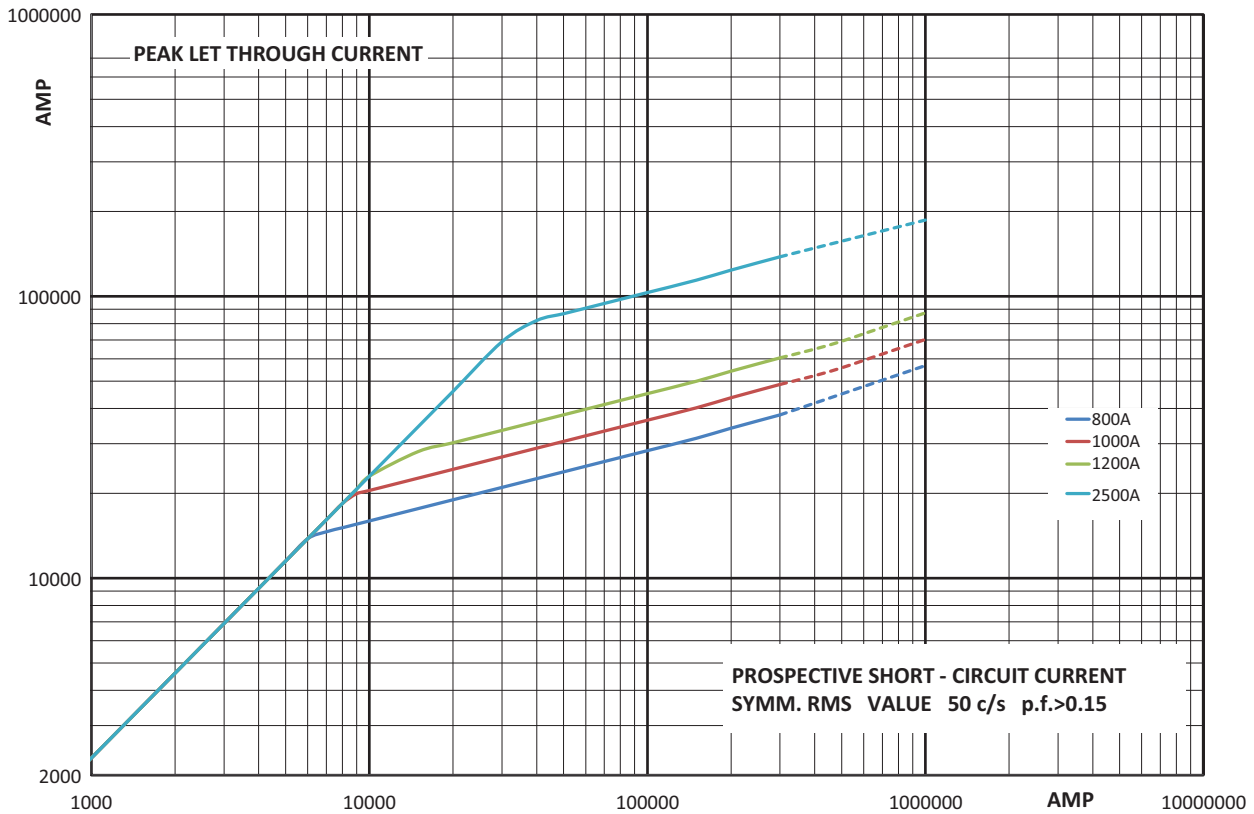

**Total clearing  $I^2t$**

The total clearing  $I^2t$  at rated voltage and at a power factor of 15 percent are given in the electrical characteristics. For other voltages, the clearing  $I^2t$  is found by multiplying by correction factor,  $K$ , given as a function of applied working voltage,  $E_g$ , (RMS).

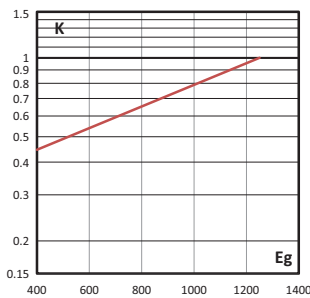

**Arc voltage**

This curve gives the peak arc voltage,  $U_L$ , which may appear across the fuse during its operation as a function of the applied working voltage,  $E_g$ , (RMS) at a power factor of 15 percent.

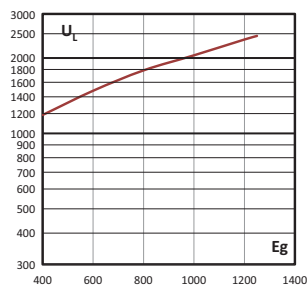

**Watts losses**

Watts loss at rated current is given in the electrical characteristics. The curve allows the calculation of the watts losses at load currents lower than the rated current. The correction factor,  $K_p$ , is given as a function of the RMS load current,  $I_b$ , in percent of the rated current.

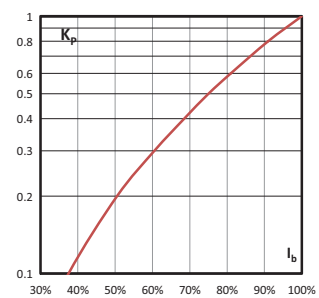

# Square body fuse links

## 170M - Size 4, Flush end contact, 1250 V a.c. (IEC), 800 A to 2500 A

### Time-current curve - 1400 A to 2400 A

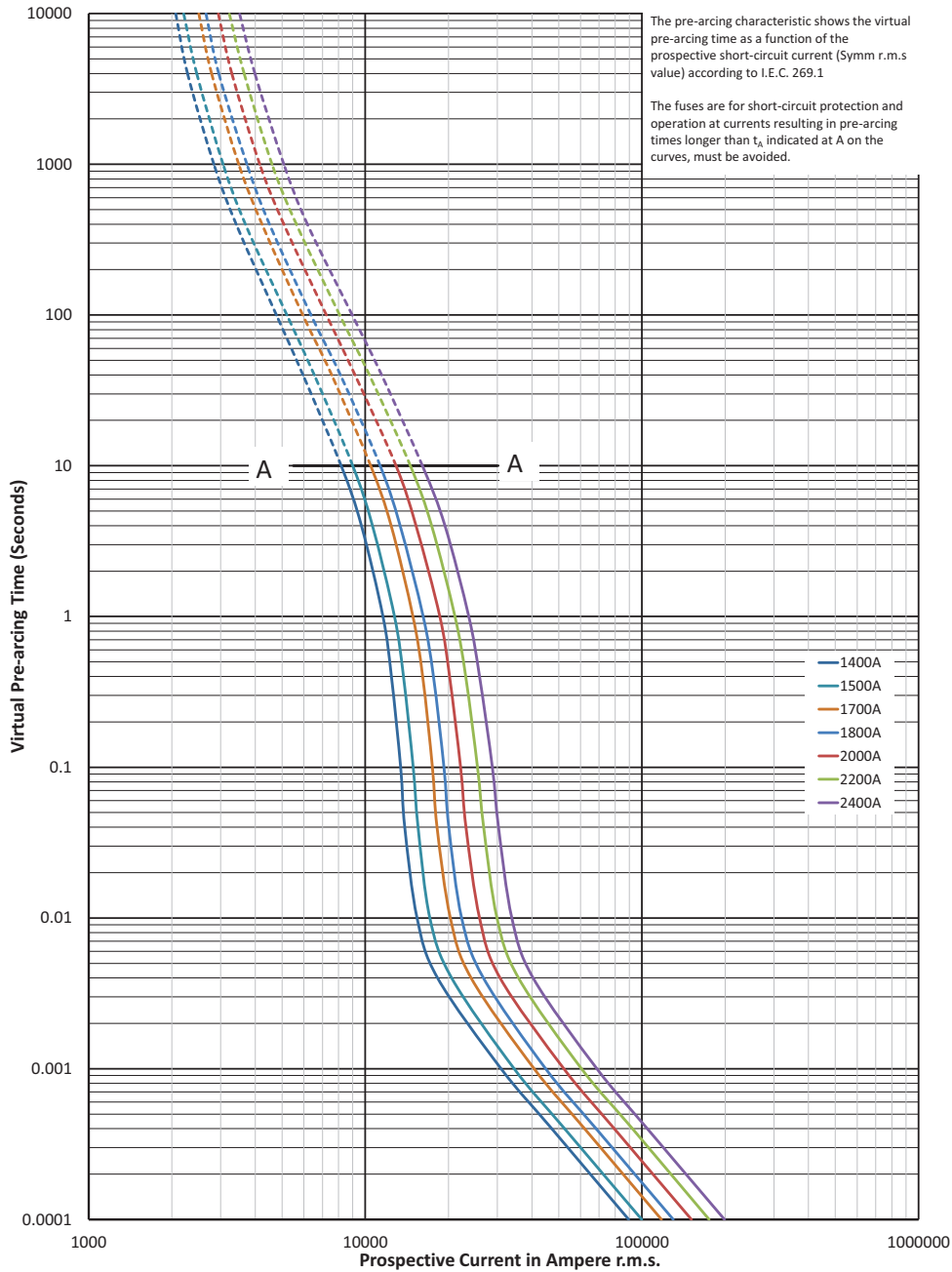

$K_b = 1$     $N = 1.7$

Data sheets: 170K6640 (1400 A to 2400 A), 170K6642 (800 A to 1200A and 2500 A)



**170M - Size 4, Flush end contact, 1250 V a.c. (IEC), 800 A to 2500 A**

Cut-off curve - 1400 A to 2400 A

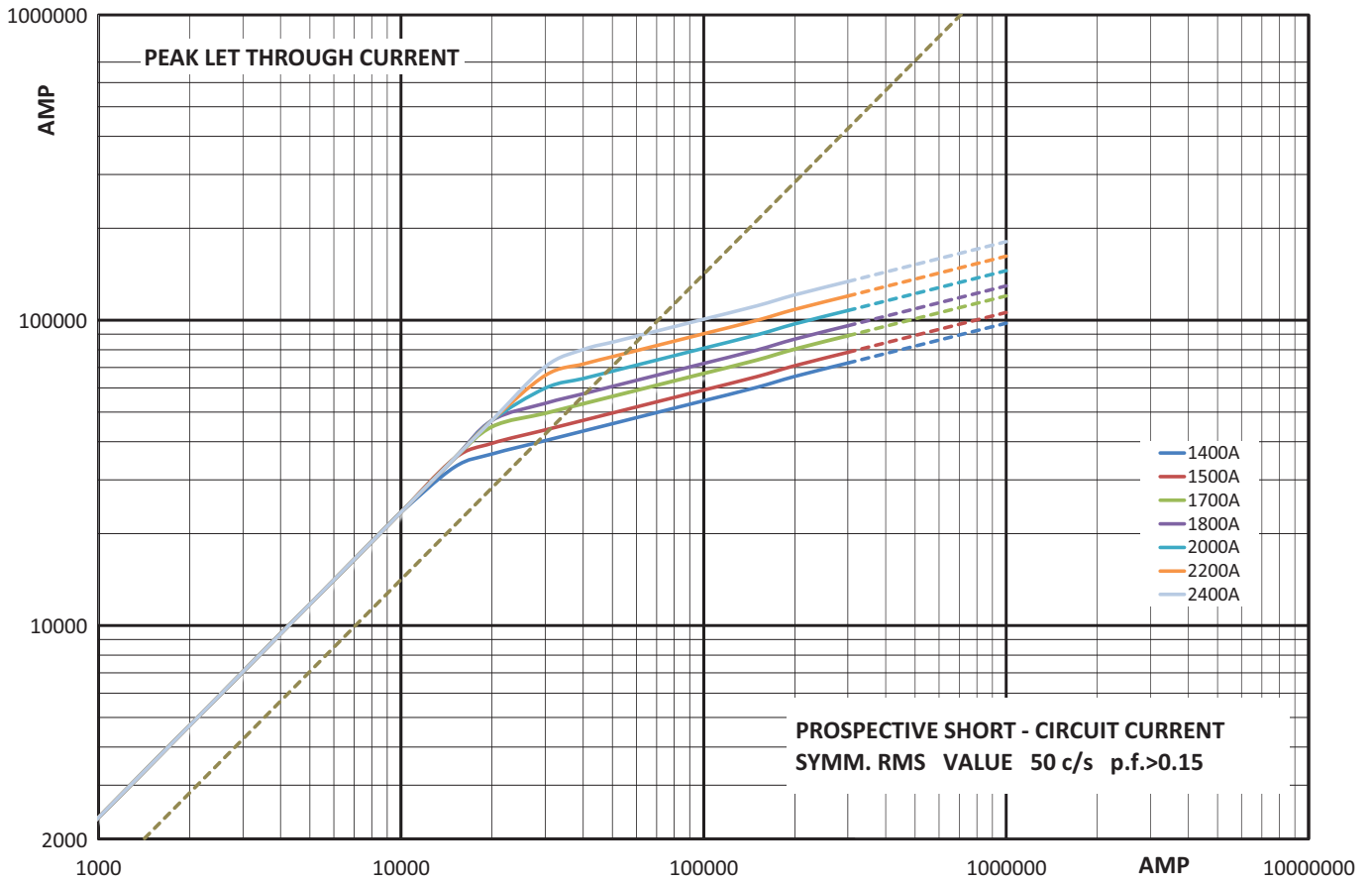

**Total clearing I<sup>2</sup>t**

The total clearing I<sup>2</sup>t at rated voltage and at a power factor of 15 percent are given in the electrical characteristics. For other voltages, the clearing I<sup>2</sup>t is found by multiplying by correction factor, K, given as a function of applied working voltage, E<sub>g</sub>, (RMS).

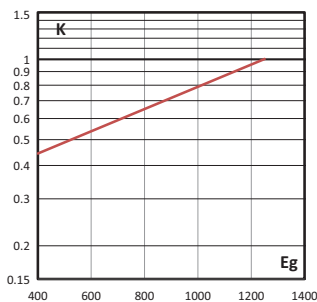

**Arc voltage**

This curve gives the peak arc voltage, U<sub>L</sub>, which may appear across the fuse during its operation as a function of the applied working voltage, E<sub>g</sub>, (RMS) at a power factor of 15 percent.

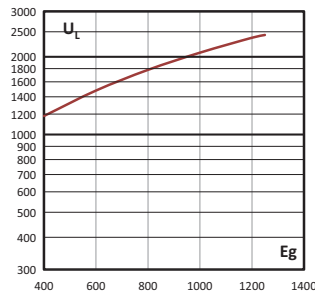

**Watts losses**

Watts loss at rated current is given in the electrical characteristics. The curve allows the calculation of the watts losses at load currents lower than the rated current. The correction factor, K<sub>p</sub>, is given as a function of the RMS load current, I<sub>b</sub>, in percent of the rated current.

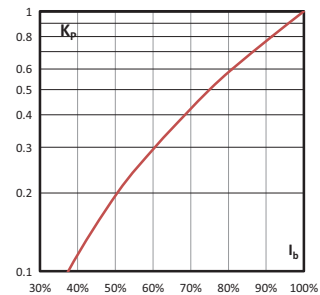

Data sheets: 170K6640 (1400 A to 2400 A), 170K6642 (800 A to 1200A and 2500 A)

# Square body fuse links

## 170M - Size 23, Flush end contact, 660 V a.c. (IEC), 1000 A to 4000 A

### Specifications

#### Description

Square body, flush end contact, high speed fuse links, for the protection of power rectifiers.

#### Technical data

- Rated voltage:
  - 660 V a.c. (IEC, 1000 A to 3000 A)
  - 600 V a.c. (IEC, 3500 A)
  - 550 V a.c. (IEC, 4000 A)
- Rated current: 1000 A to 4000 A
- Breaking capacity: 100 kA RMS Sym
- Operating class: aR



#### Standards / Agency information

CE, Designed and tested to IEC 60269 Part 4

#### Catalogue numbers

Fuse link body size	Rated voltage	Rated current (Amps)	I <sup>2</sup> t (A <sup>2</sup> Sec)		Watts loss (W)	Catalogue numbers					
			Pre-arcing	Clearing at 660 V a.c.		-BU/55	-BKE/55 Type K indicator	-BKN/55 Type K indicator	-GU/55	-GKE/55 Type K Indicator	-GKN/55 Type K Indicator
23	660 V a.c. (IEC)	1000	79,000	530,000	170	170M6858	170M6898	170M6878	170M6918	170M6958	170M6938
		1100	95,000	635,000	185	170M6859	170M6899	170M6879	170M6919	170M6959	170M6939
		1250	155,000	1,050,000	190	170M6860	170M6900	170M6880	170M6920	170M6960	170M6940
		1400	200,000	1,350,000	210	170M6861	170M6901	170M6881	170M6921	170M6961	170M6941
		1500	240,000	1,650,000	215	170M6862	170M6902	170M6882	170M6922	170M6962	170M6942
		1600	315,000	2,150,000	220	170M6863	170M6903	170M6883	170M6923	170M6963	170M6943
		1800	450,000	3,050,000	230	170M6864	170M6904	170M6884	170M6924	170M6964	170M6944
		2000	625,000	4,200,000	240	170M6865	170M6905	170M6885	170M6925	170M6965	170M6945
		2200	805,000	5,400,000	255	170M6866	170M6906	170M6886	170M6926	170M6966	170M6946
		2500	1,250,000	8,350,000	265	170M6867	170M6907	170M6887	170M6927	170M6967	170M6947
	3000	2,250,000	15,500,000	285	170M6868	170M6908	170M6888	170M6928	170M6968	170M6948	
	600 V a.c. (IEC)	3500	3,450,000	21,000,000 <sup>1</sup>	315	170M6869	170M6909	170M6889	170M6929	170M6969	170M6949
	550 V a.c. (IEC)	4000	5,000,000	27,500,000 <sup>2</sup>	340	170M6870	170M6910	170M6890	170M6930	170M6970	170M6950

<sup>1</sup> Clearing at 600 V a.c.

<sup>2</sup> Clearing at 550 V a.c.

When using these fuse links, please consult Eaton for application assistance at [bulehighspeedtechnical@eaton.com](mailto:bulehighspeedtechnical@eaton.com).

**170M - Size 23, Flush end contact, 660 V a.c. (IEC), 1000 A to 4000 A**

Dimensions (mm) -BU/55, -BKE/55 and -BKN/55

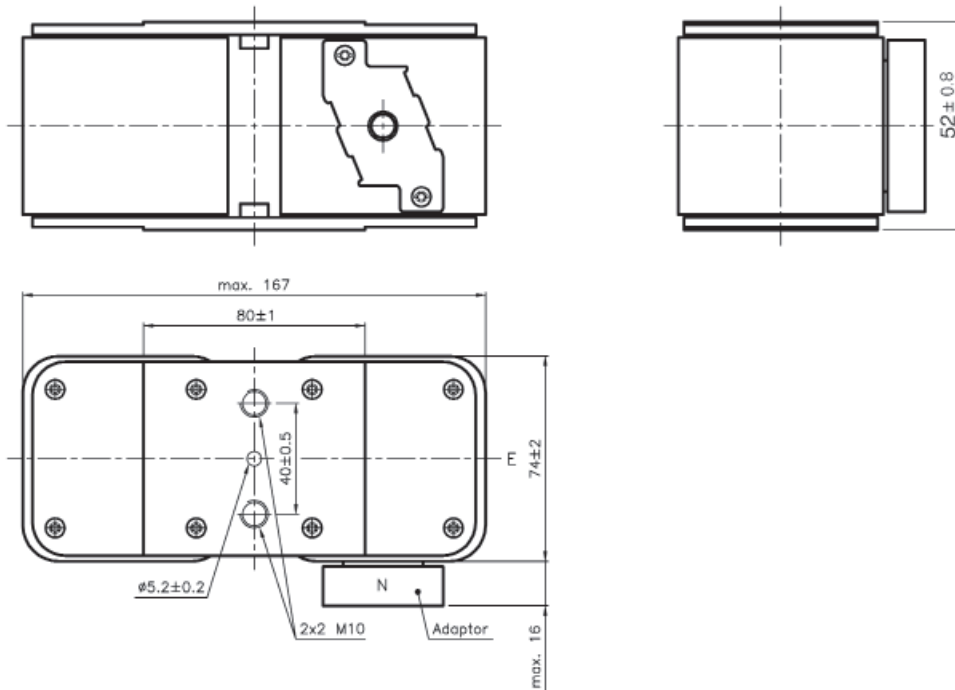

Dimensions (mm) -GU/55, -GKE/55 and -GKN/55

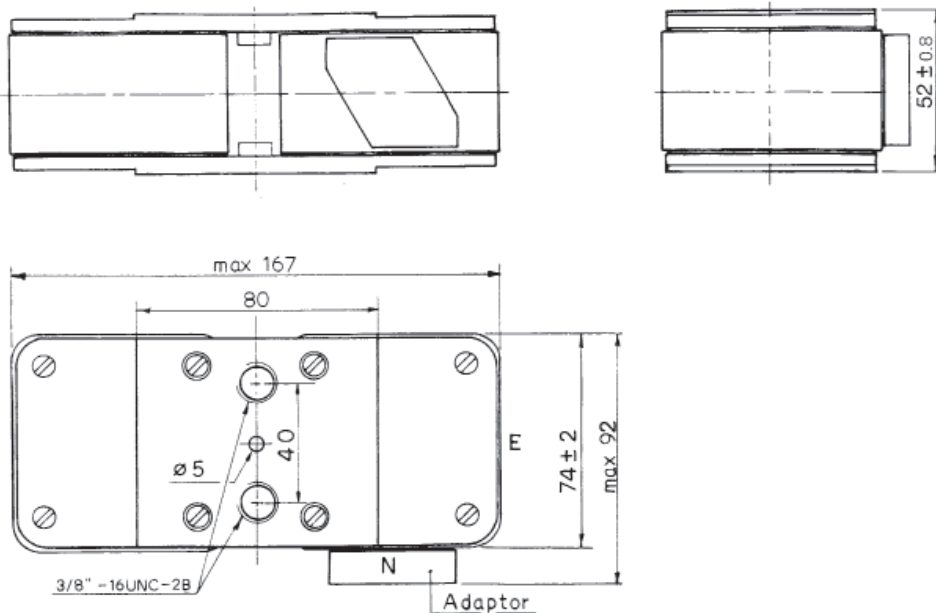

Type -GU/55, -GKE/55, -GKN/55

When using these fuse links, please consult Eaton for application assistance at [bulehighspeedtechnical@eaton.com](mailto:bulehighspeedtechnical@eaton.com).

# Square body fuse links

## 170M - Size 23, Flush end contact, 660 V a.c. (IEC), 1000 A to 4000 A

### Time-current curve - 1000 A to 4000 A

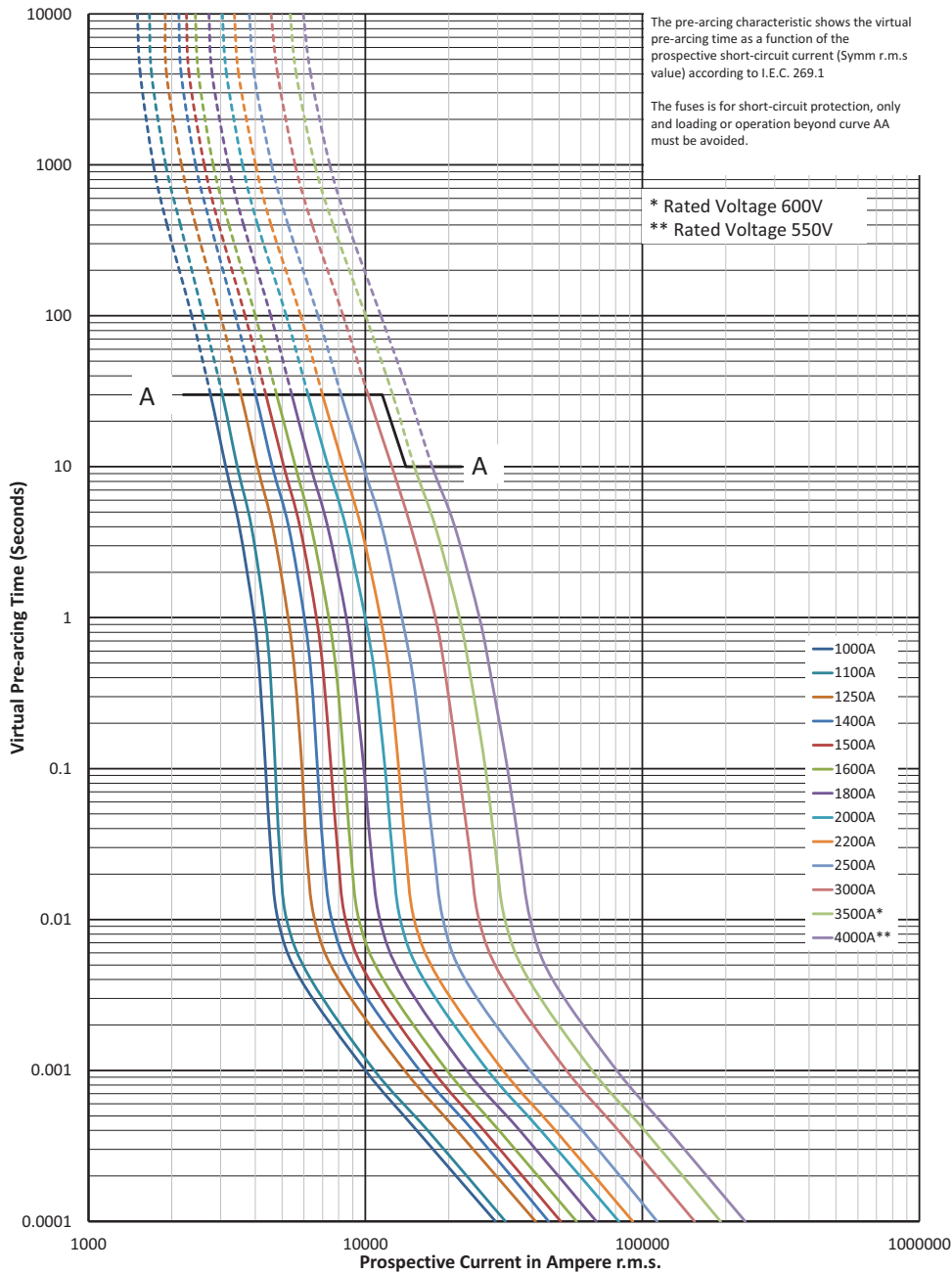

$K_b = 1$   $N = 1.5$

**170M - Size 23, Flush end contact, 660 V a.c. (IEC), 1000 A to 4000 A**

**Cut-off curve - 1000 A to 4000 A**

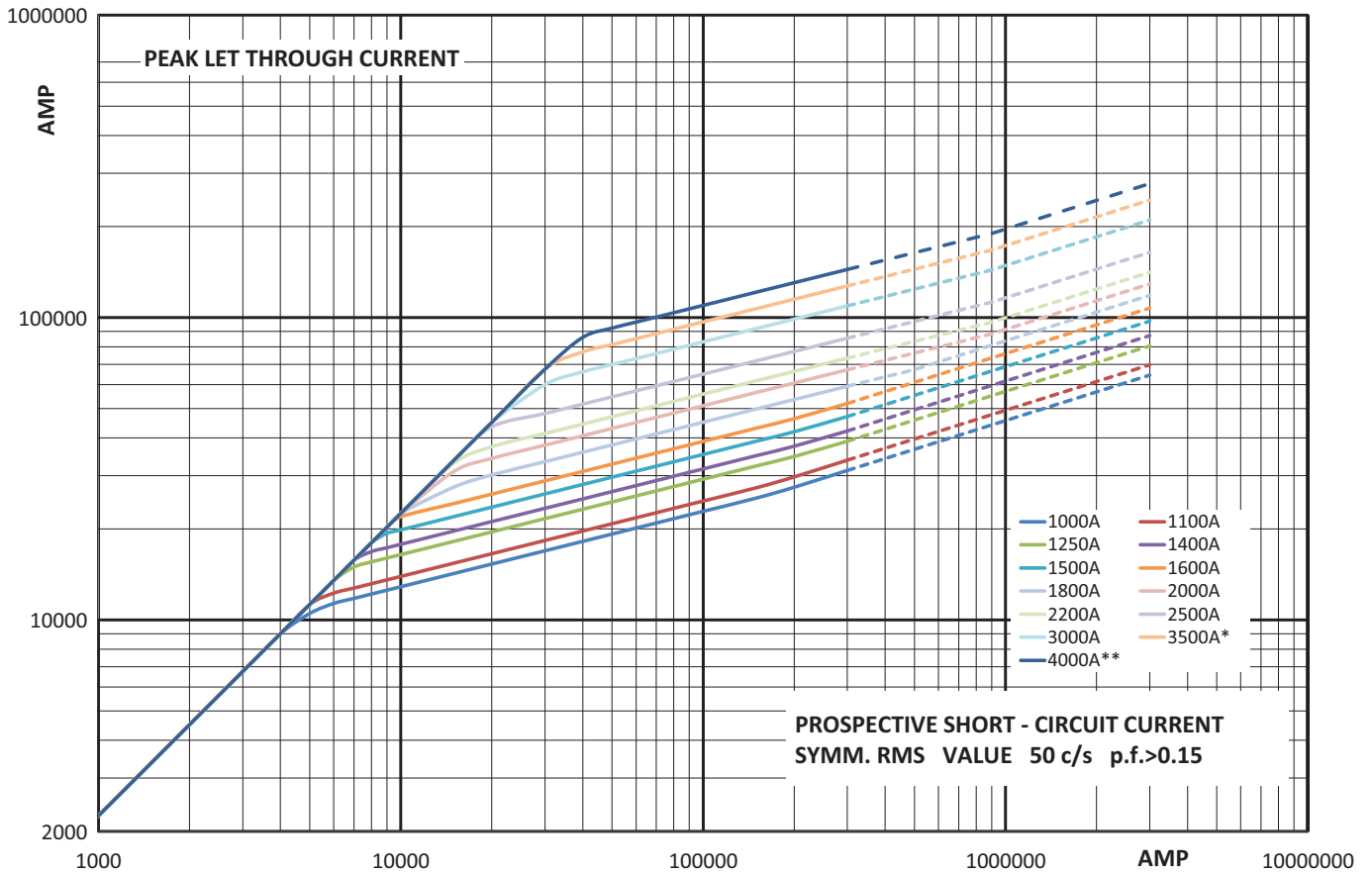

**Total clearing I<sup>2</sup>t**

The total clearing I<sup>2</sup>t at rated voltage and at a power factor of 15 percent are given in the electrical characteristics. For other voltages, the clearing I<sup>2</sup>t is found by multiplying by correction factor, K, given as a function of applied working voltage, E<sub>g</sub>, (RMS).

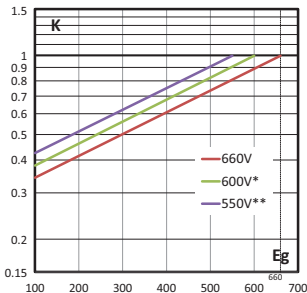

**Arc voltage**

This curve gives the peak arc voltage, U<sub>L</sub>, which may appear across the fuse during its operation as a function of the applied working voltage, E<sub>g</sub>, (RMS) at a power factor of 15 percent.

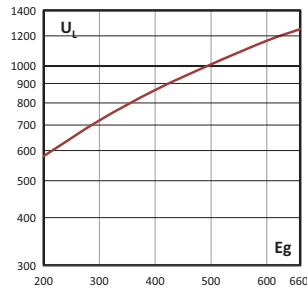

**Watts losses**

Watts loss at rated current is given in the electrical characteristics. The curve allows the calculation of the watts losses at load currents lower than the rated current. The correction factor, K<sub>p</sub>, is given as a function of the RMS load current, I<sub>b</sub>, in percent of the rated current.

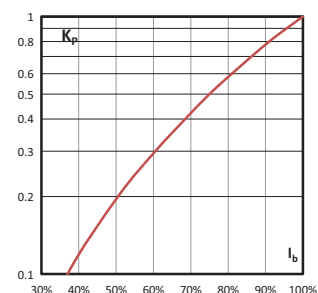

# Square body fuse links

## 170M - Size 23, Flush end contact, 1250 V a.c. (IEC), 630 A to 2800 A

### Specifications

#### Description

Square body, flush end contact, high speed fuse links, for the protection of power rectifiers.

#### Technical data

- Rated voltage:
  - 1250 V a.c. (IEC 630 A to 2200 A)
  - 1100 V a.c. (IEC 2500 A and 2800 A)
- Rated current: 630 A to 2800 A
- Breaking capacity: 125kA RMS Sym
- Operating class: aR



#### Standards / Agency information

CE, Designed and tested to IEC 60269 Part 4

#### Catalogue numbers

Fuse link body size	Rated voltage	Rated current (Amps)	I <sup>2</sup> t (A <sup>2</sup> Sec)		Watts loss (W)	Catalogue numbers					
			Pre-arcing	Clearing at 1250 V a.c.		-BU/75 Visual indicator	-BKE/75 Type K indicator	-BKN/75 Type K indicator	-BU/80 Visual indicator	-BKE/80 Type K Indicator	-BKN/80 Type K Indicator
23	1250 V a.c. (IEC)	630	38,000	310,000	170	170M6775	170M6795	170M6785			
		700	54,000	440,000	180	170M6776	170M6796	170M6786			
		800	78,000	640,000	190	170M6777	170M6797	170M6787			
		900	120,000	980,000	200	170M6805	170M6807	170M6806			
		1000	155,000	1,250,000	210	170M6778	170M6798	170M6788			
		1100	220,000	1,750,000	220	170M6779	170M6799	170M6789 <sup>3</sup>			
		1250	330,000	2,700,000	230	170M6780	170M6800	170M6790			
		1300	460,000	3,800,000	240	170M6781	170M6801	170M6791			
		1600	820,000	5,200,000	250	170M6782	170M6802	170M6792			
		1800	1,200,000	7,600,000	260	170M6783 <sup>2</sup>	170M6803 <sup>2</sup>	170M6793 <sup>2</sup>			
	2000	1,800,000	11,000,000	270				170M6784	170M6804	170M6794	
	2100	2,300,000	14,500,000	280				170M6815	170M6833	170M6827	
	1100 V a.c. (IEC)	2500	3,200,000	16,000,000 <sup>1</sup>	290				170M6816	170M6834	170M6828
	2800	5,000,000	24,000,000 <sup>1</sup>	300				170M6817	170M6835	170M6829	

<sup>1</sup> Clearing at 1000 V

<sup>2</sup> Rated voltage 900 V d.c. 10XIn 90 kA

<sup>3</sup> 1000 V d.c. UL 50 kA IR

When using these fuse links, please consult Eaton for application assistance at [bulehighspeedtechnical@eaton.com](mailto:bulehighspeedtechnical@eaton.com).

#### Dimensions (mm)

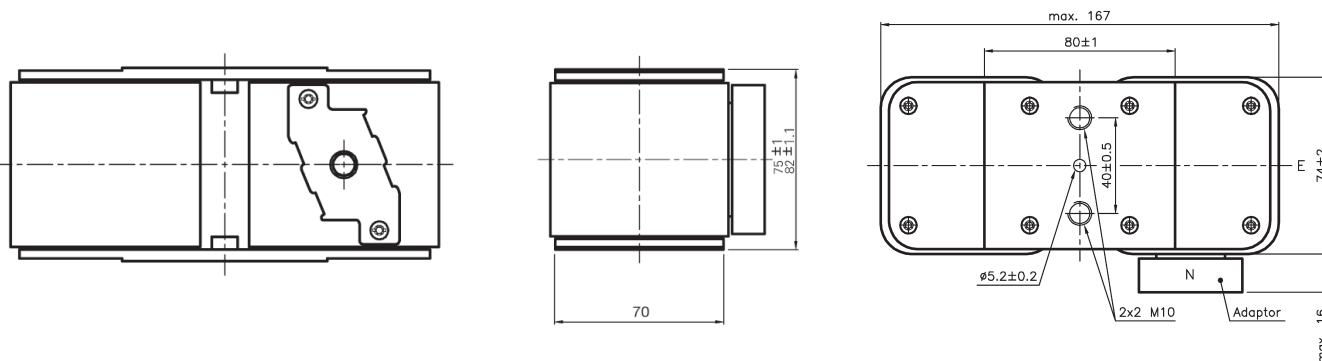

**170M - Size 23, Flush end contact, 1250 V a.c. (IEC), 630 A to 2800 A**

Time-current curve - 630 A to 2800 A

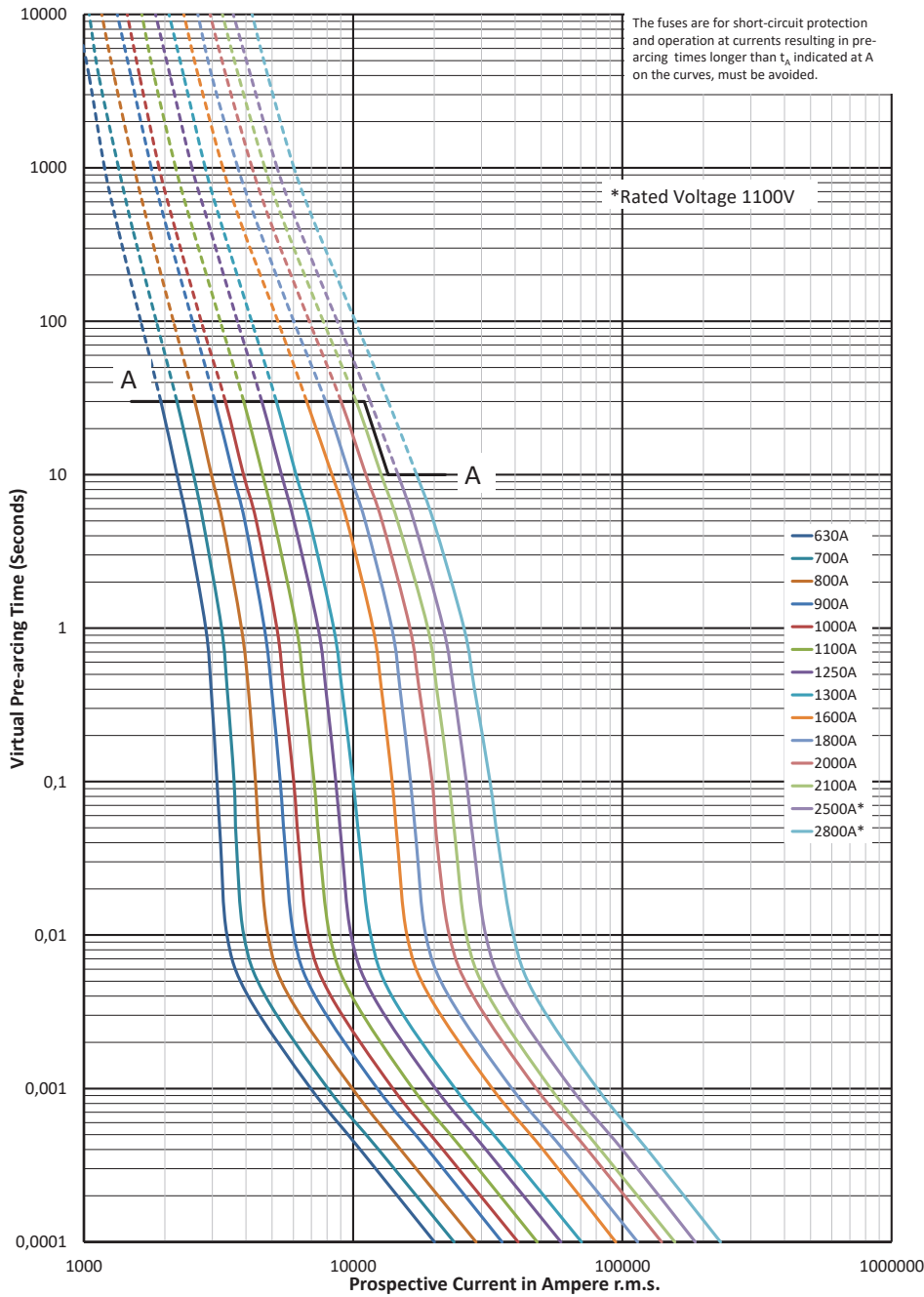

# Square body fuse links

## 170M - Size 23, Flush end contact, 1250 V a.c. (IEC), 630 A to 2800 A

### Cut-off curve - 630 A to 2800 A

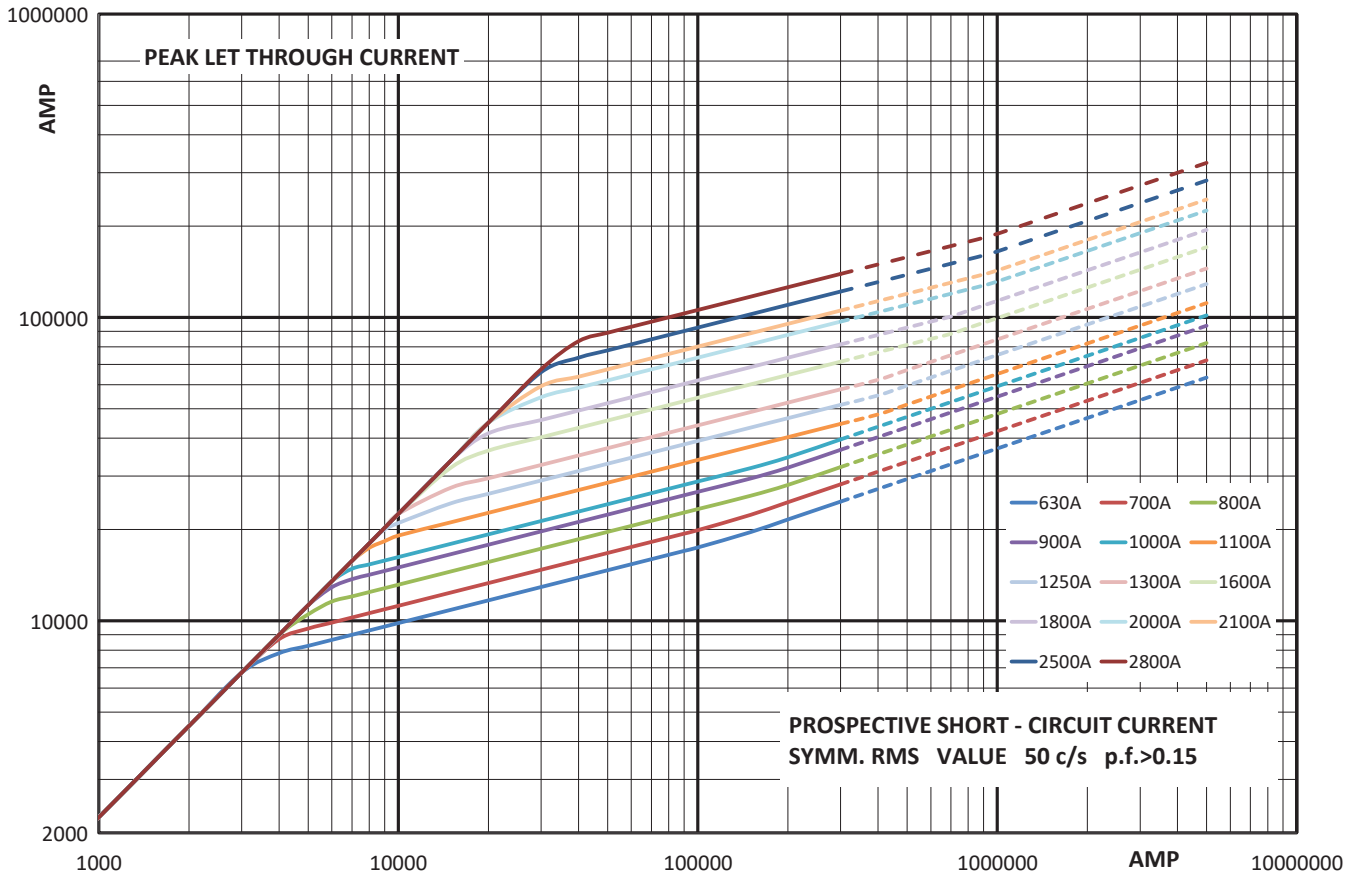

### Total clearing $I^2t$

The total clearing  $I^2t$  at rated voltage and at a power factor of 15 percent are given in the electrical characteristics. For other voltages, the clearing  $I^2t$  is found by multiplying by correction factor,  $K$ , given as a function of applied working voltage,  $E_g$ , (RMS).

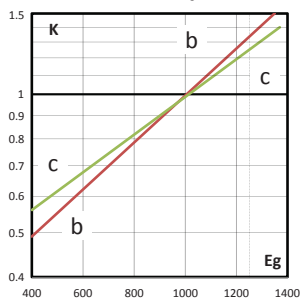

B: fuses  $\leq 1400$  A

C: fuses  $\geq 1600$  A

### Arc voltage

This curve gives the peak arc voltage,  $U_L$ , which may appear across the fuse during its operation as a function of the applied working voltage,  $E_g$ , (RMS) at a power factor of 15 percent.

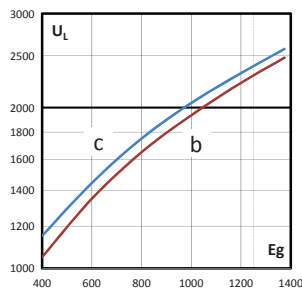

B: fuses  $\leq 1400$  A

C: fuses  $\geq 1600$  A

### Watts losses

Watts loss at rated current is given in the electrical characteristics. The curve allows the calculation of the watts losses at load currents lower than the rated current. The correction factor,  $K_p$ , is given as a function of the RMS load current,  $I_b$ , in percent of the rated current.

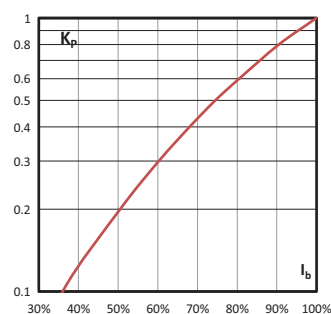



**170M - Size 24, Flush end contact, 690 V a.c. (IEC), 700 V a.c. (UL), 2000 A to 6500 A**

**Specifications**

**Description**

Square body, flush end contact, high speed fuse links, for the protection of power rectifiers.

**Technical data**

- Rated voltage: 690 V a.c. (IEC) / 700 V a.c. (UL)
- Rated current: 2000 A to 6500 A
- Breaking capacity: 200 kA RMS Sym
- Operating class: aR



**Standards / Agency information**

CE, Designed and tested to IEC 60269 Part 4, UL Recognised

**Catalogue numbers**

Fuse link body size	Rated voltage	Rated current (Amps)	I <sup>2</sup> t (A <sup>2</sup> Sec)		Watts loss (W)	Catalogue numbers			
			Pre-arcing	Clearing at 660 V a.c.		-BU/60 Without indicator	-BKN/60 Type K indicator	-GU/60 Without indicator	-GKN/60 Type K indicator
24	690 V a.c. (IEC) 700 V a.c. (UL)	2000	340,000	2,300,000	340	170M7138	170M7158	170M7198	170M7218
		2500	650,000	4,350,000	390	170M7139	170M7159	170M7199	170M7219
		3000	1,100,000	7,300,000	430	170M7140	170M7160	170M7200	170M7220
		3500	1,800,000	12,000,000	460	170M7141	170M7161	170M7201	170M7221
		4000	2,700,000	18,000,000	490	170M7142	170M7162	170M7202	170M7222
		4500	3,800,000	25,500,000	520	170M7143	170M7163	170M7203	170M7223
		5000	5,450,000	36,500,000	540	170M7144	170M7164	170M7204	170M7224
		5500	7,400,000	49,500,000	560	170M7145	170M7165	170M7205	170M7225
		6000	9,600,000	64,000,000	580	170M7146	170M7166	170M7206	170M7226
		6500	12,500,000	83,000,000	600	170M7147	170M7167	170M7207	170M7227

**Dimensions (mm)**

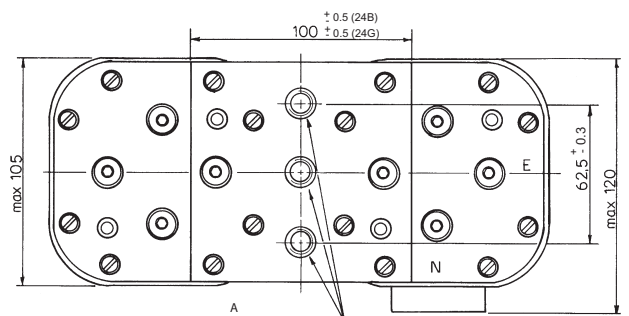
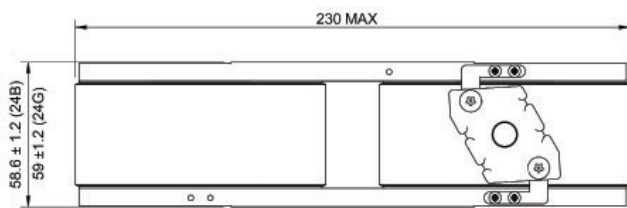

Size	Type	A
24	BKN	2x3 M12
24	GKN	2x3 ½" -13 UNC-2B

When using these fuse links, please consult Eaton for application assistance at [bulehighspeedtechnical@eaton.com](mailto:bulehighspeedtechnical@eaton.com)

# Square body fuse links

## 170M - Size 24, Flush end contact, 690 V a.c. (IEC), 700 V a.c. (UL), 2000 A to 6500 A

### Time-current curve - 2000 A to 7500 A

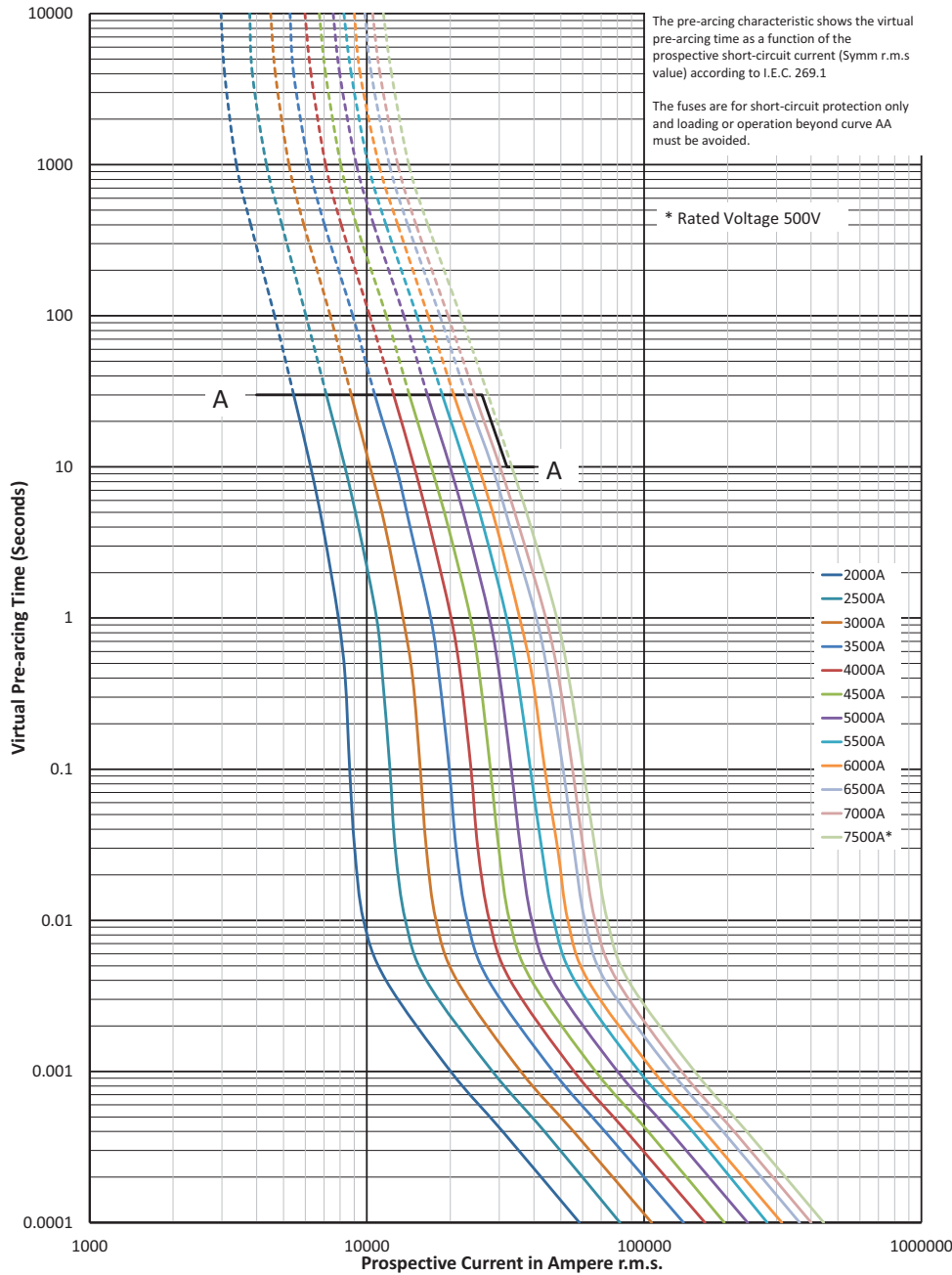

$K_b = 1$   $N = 1.5$

## 170M - Size 24, Flush end contact, 690 V a.c. (IEC), 700 V a.c. (UL), 2000 A to 6500 A

Cut-off curve - 2000 A to 7500 A

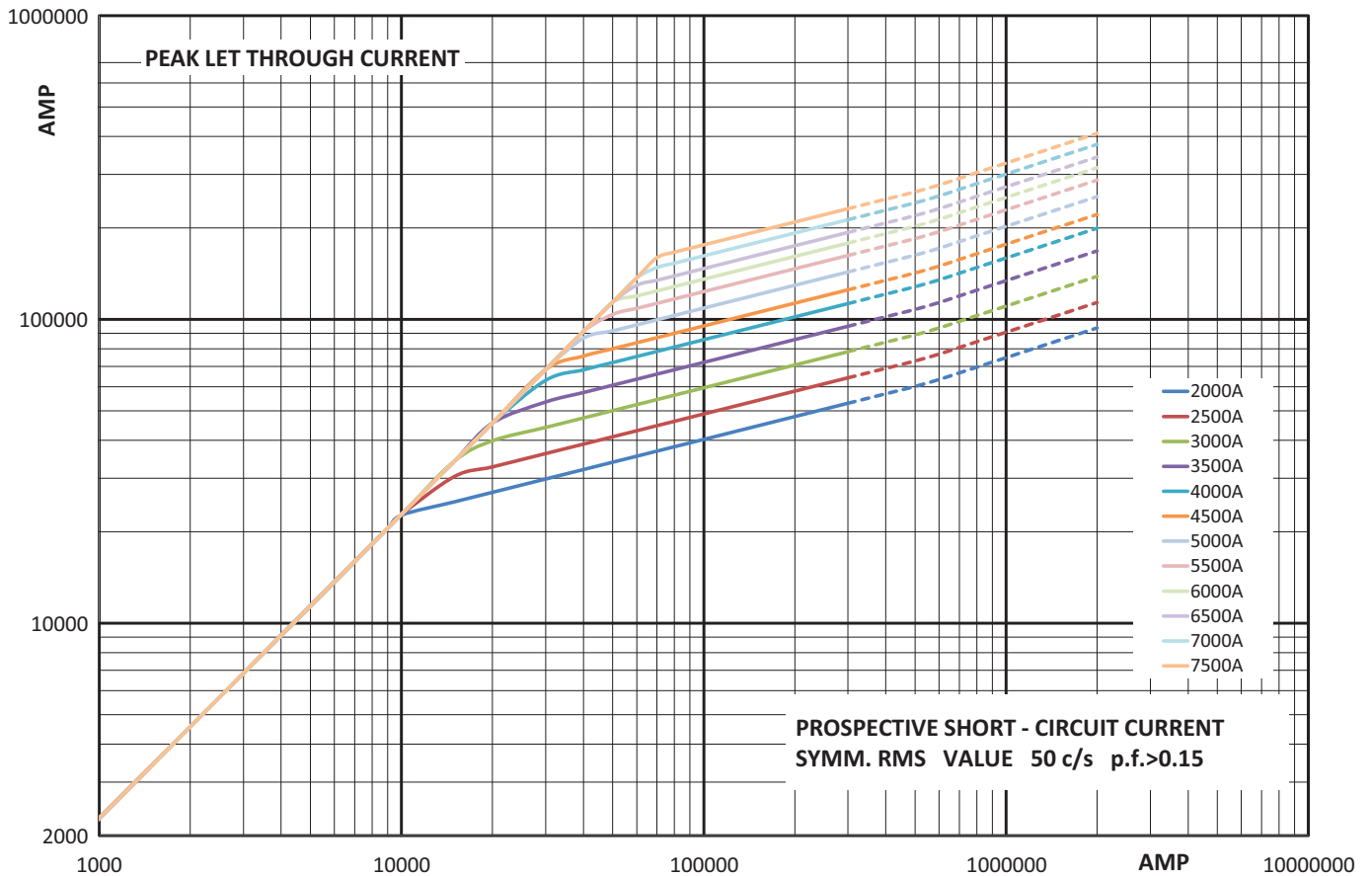

### Total clearing $I^2t$

The total clearing  $I^2t$  at rated voltage and at a power factor of 15 percent are given in the electrical characteristics. For other voltages, the clearing  $I^2t$  is found by multiplying by correction factor,  $K$ , given as a function of applied working voltage,  $E_g$ , (RMS).

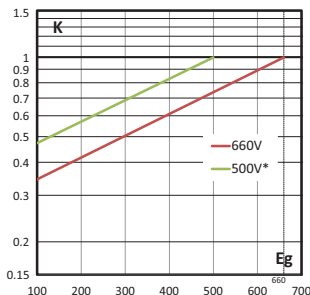

### Arc voltage

This curve gives the peak arc voltage,  $U_L$ , which may appear across the fuse during its operation as a function of the applied working voltage,  $E_g$ , (RMS) at a power factor of 15 percent.

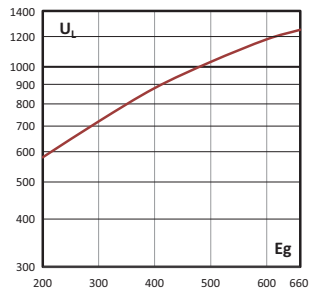

### Watts losses

Watts loss at rated current is given in the electrical characteristics. The curve allows the calculation of the watts losses at load currents lower than the rated current. The correction factor,  $K_p$ , is given as a function of the RMS load current,  $I_b$ , in percent of the rated current.

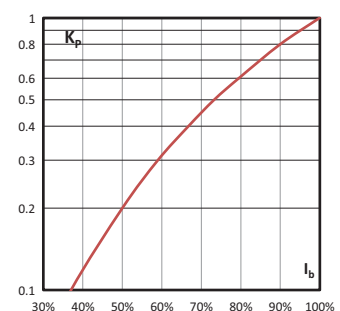

# Square body fuse links

## 170M - Size 24, Flush end contact, 1000 V a.c. (IEC and UL), 2000 A to 5000 A

### Specifications

#### Description

Square body, flush end contact, high speed fuse links, for the protection of power rectifiers.

#### Technical data

- Rated voltage: 1000 V a.c. (IEC and UL)
- Rated current: 2000 A to 5000 A
- Breaking capacity: 166 kA RMS Sym / 100 kA RMS (UL)
- Operating class: aR

#### Standards / Agency information

CE, Designed and tested to IEC 60269 Part 4, UL Recognised



### Catalogue numbers

Fuse link body size	Rated voltage	Rated current (Amps)	I <sup>2</sup> t (A <sup>2</sup> Sec)			Catalogue numbers
			Pre-arcing	Clearing at 1000 V a.c.	Watts loss (W)	-BKN/85 Type K indicator
24	1000 V a.c. (IEC & UL)	2000	900,000	5,350,000	345	170M7608
		3000	2,950,000	17,500,000	430	170M7680
		3200	3,300,000	20,000,000	440	170M7567
		3500	4,500,000	27,000,000	450	170M7568
		4000	6,800,000	40,000,000	475	170M7569
		4200	8,000,000	47,500,000	485	170M7498
		4500	10,000,000	59,000,000	495	170M7488
		5000	14,000,000	82,500,000	540	170M7622

### Dimensions (mm)

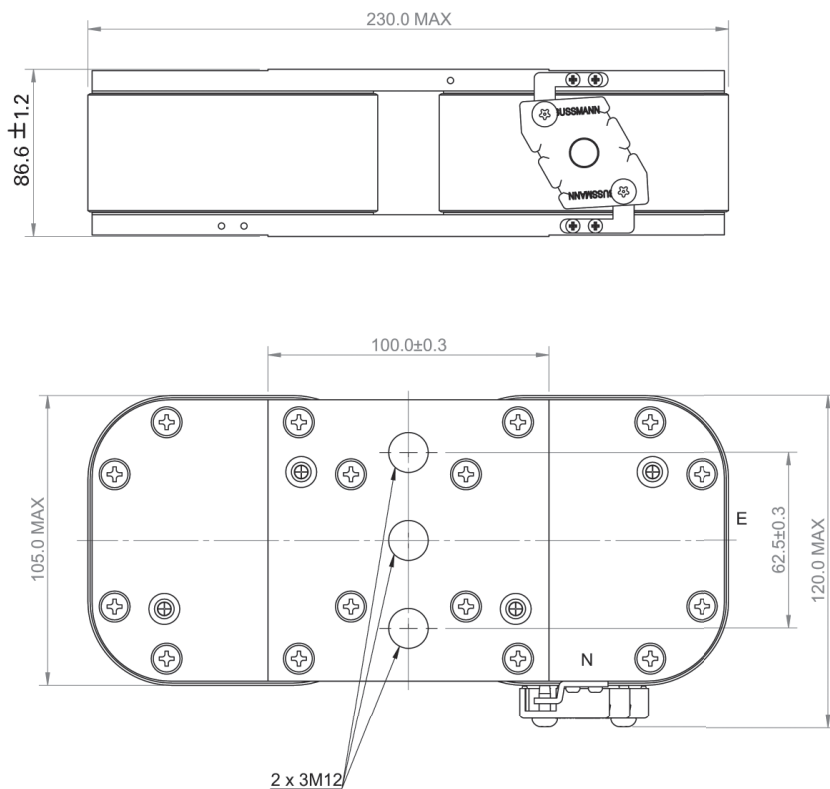

The normal position of the indicator is as shown position N, position E on request only

When using these fuse links, please consult Eaton for application assistance at [bulehighspeedtechnical@eaton.com](mailto:bulehighspeedtechnical@eaton.com).

Data sheets: 170K8514

**170M - Size 24, Flush end contact, 1000 V a.c. (IEC and UL), 2000 A to 5000 A**

Time-current curve - 2000 A to 5000 A

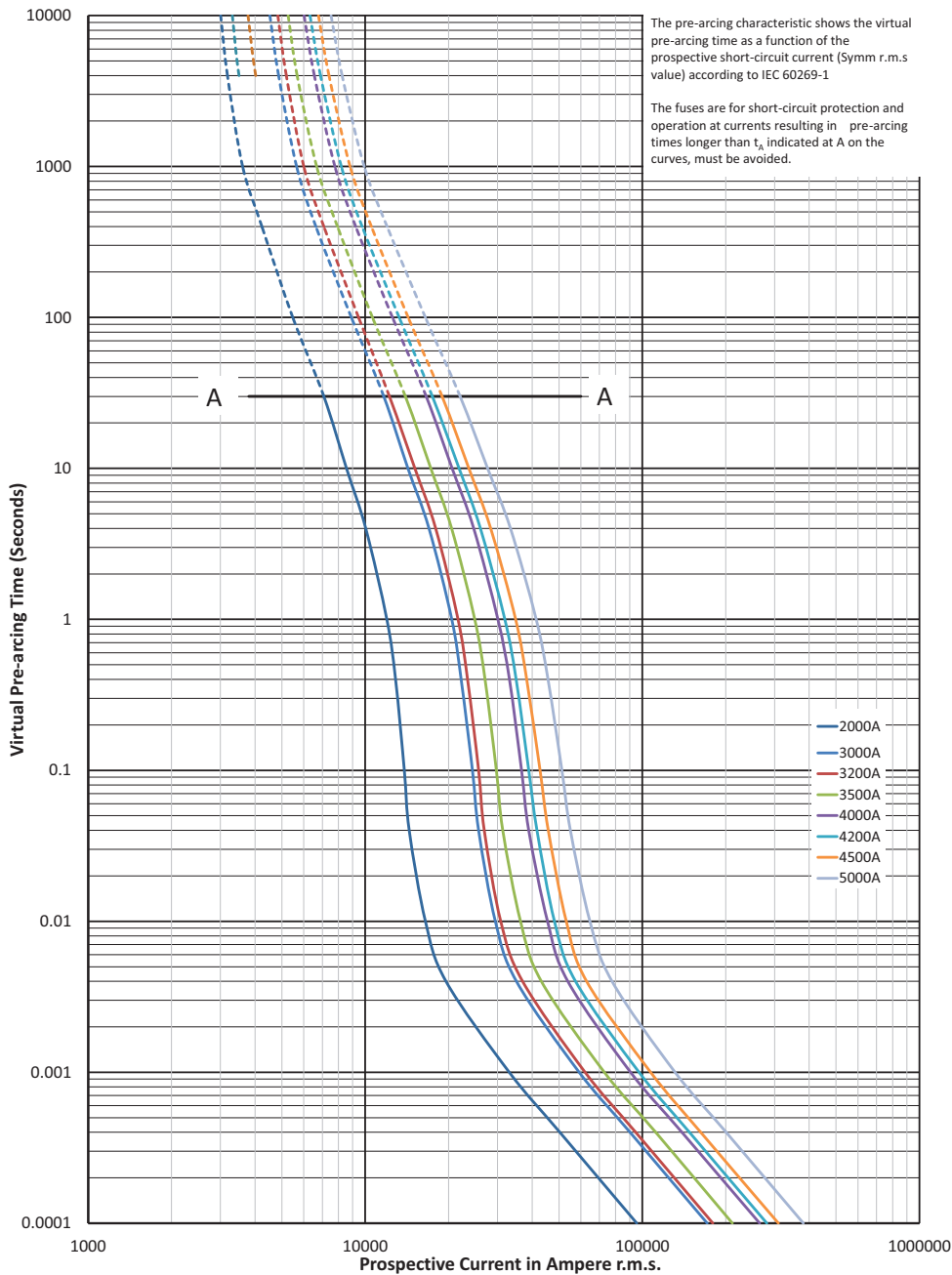

$K_b = 1 \quad N = 1.5$

# Square body fuse links

## 170M - Size 24, Flush end contact, 1000 V a.c. (IEC and UL), 2000 A to 5000 A

### Cut-off curve - 2000 A to 5000 A

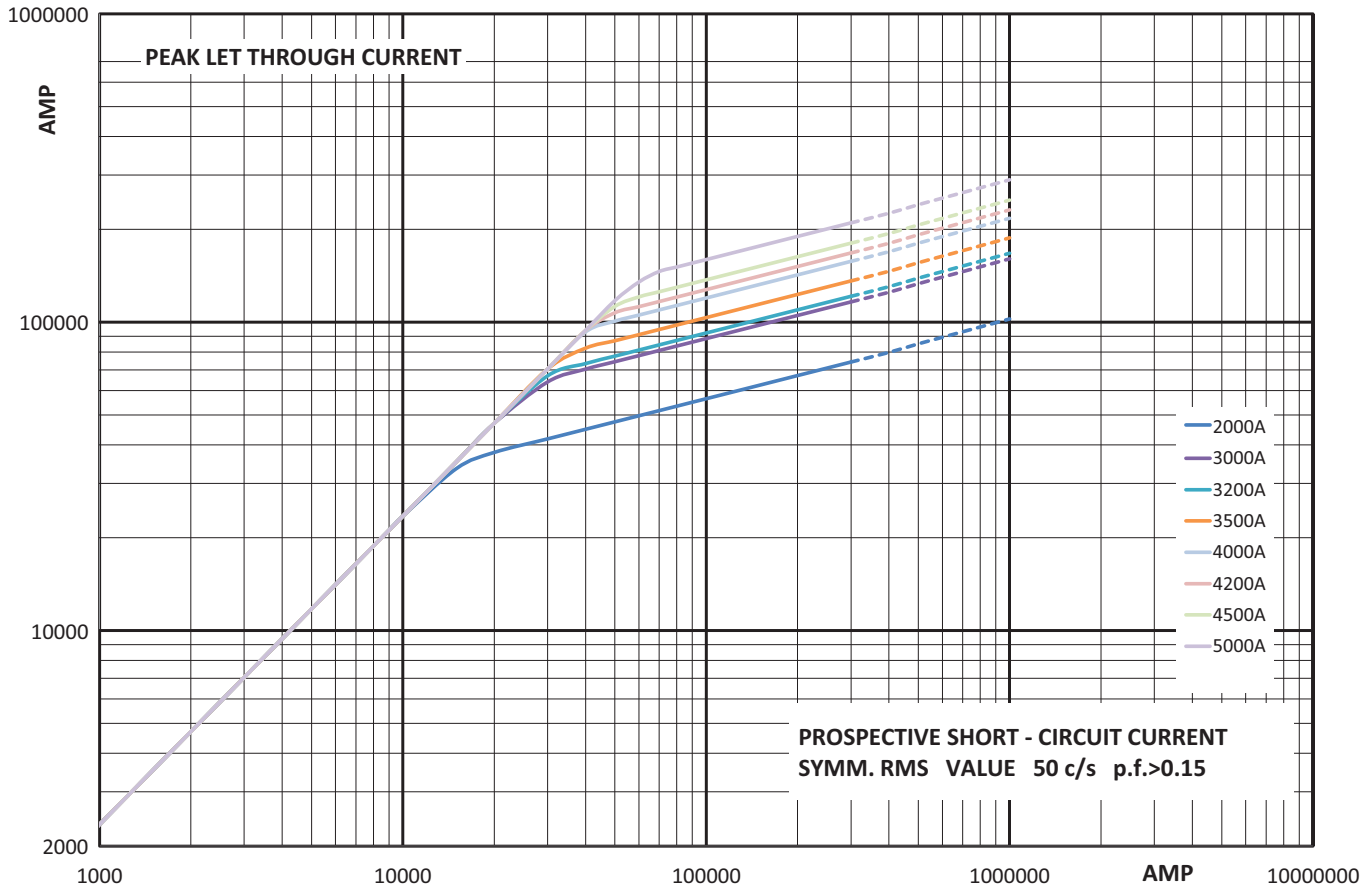

### Total clearing I<sup>2</sup>t

The total clearing I<sup>2</sup>t at rated voltage and at a power factor of 15 percent are given in the electrical characteristics. For other voltages, the clearing I<sup>2</sup>t is found by multiplying by correction factor, K, given as a function of applied working voltage, E<sub>g</sub>, (RMS).

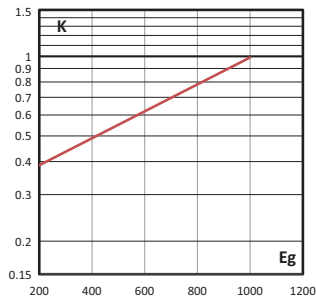

### Arc voltage

This curve gives the peak arc voltage, U<sub>L</sub>, which may appear across the fuse during its operation as a function of the applied working voltage, E<sub>g</sub>, (RMS) at a power factor of 15 percent.

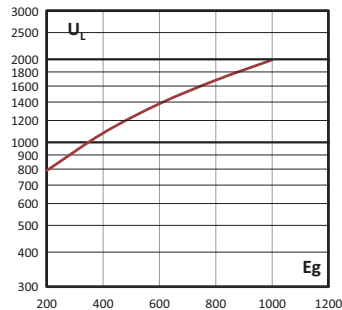

### Watts losses

Watts loss at rated current is given in the electrical characteristics. The curve allows the calculation of the watts losses at load currents lower than the rated current. The correction factor, K<sub>p</sub>, is given as a function of the RMS load current, I<sub>b</sub>, in percent of the rated current.

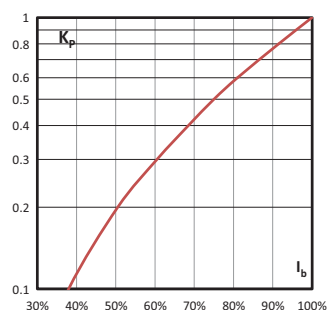

## 170M - Size 5, Flush end contact, 1100-2000 V a.c. (IEC), 1800 A to 5500 A

### Specifications

#### Description

Square body flush end contact high speed fuse links, for the protection or isolation for components such as diodes, silicon controlled rectifiers (SCRs), Gate Turn-Off Thyristors (GTOs) and IGBTs. Typical application include AC and DC drives, high power rectifiers.

#### Technical data

- Rated voltage: 1100-2000 V a.c. (IEC)
- Rated current: 1800 A to 5500 A
- Breaking capacity: 300 kA RMS Sym. estimated: 197 kA tested
- Operating class: aR

#### Standards / Agency information

Consult Eaton [bulehighspeedtechnical@eaton.com](mailto:bulehighspeedtechnical@eaton.com)

#### Catalogue Numbers

Consult Eaton [bulehighspeedtechnical@eaton.com](mailto:bulehighspeedtechnical@eaton.com)



### Dimensions (mm)

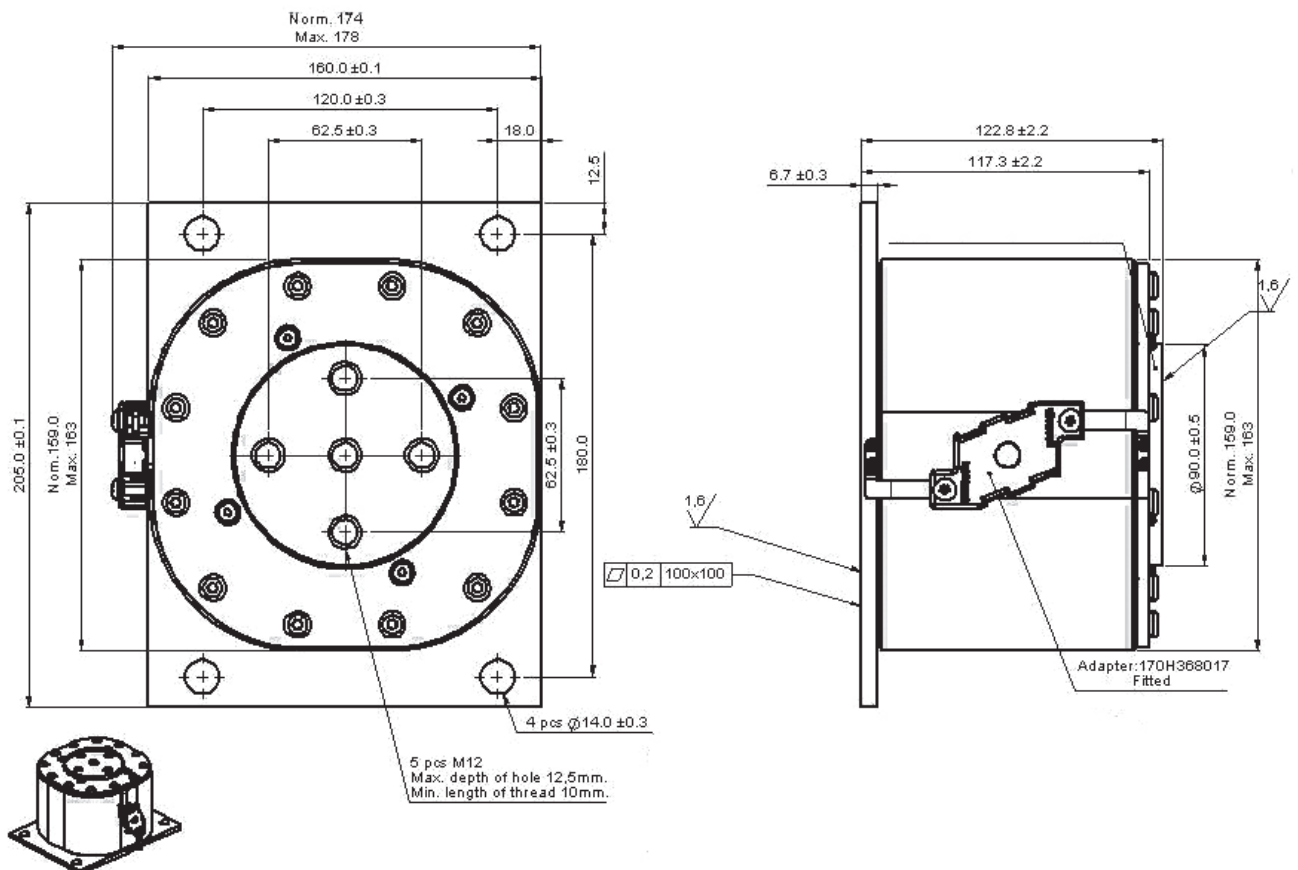

This dimension drawing is an example of the range of size 5 fuse links available.

# Square body fuse links

## DFJ - Drive fuse links, 600 V a.c. / 450 V d.c. (UL), 1 A to 600 A

### Specifications

#### Description

Bolted tags high speed fuse links that provide maximum protection for AC and DC drives and controllers. The DFJ fuse link has the lowest I<sup>2</sup>t of any branch circuit fuse to protect power semi-conductor devices that utilise diodes, GTOs, SCRs and SSRs. The DFJ fuse links combine the performance of high speed fuse links and the convenience of Class J branch circuit fuse links, allowing the use of readily available Class J fuse blocks, holders and switches.

#### Technical data

- Rated voltage: 600 V a.c. / 450 V d.c. (UL)
- Rated current: 1 A to 600 A
- Breaking capacity: 200 kA RMS Sym., 100 kA DC
- Operating class: aR
- 

#### Standards / Agency information

UL Listed, Std 248-8, Class J, Guide JDDZ, File E4273 CSA Certified, C22-2 No 248.8, Class 1422-02, File 53787 meets NEC branch circuit protection.



#### Catalogue numbers

Rated voltage	Rated current (Amps)	Catalogue numbers
	1	DFJ-1
	2	DFJ-2
	3	DFJ-3
	4	DFJ-4
	5	DFJ-5
	6	DFJ-6
	8	DFJ-8
600 V a.c./ 450 V d.c. (UL)	10	DFJ-10
	12	DFJ-12
	15	DFJ-15
	20	DFJ-20
	25	DFJ-25
	30	DFJ-30
	40	DFJ-40
	45	DFJ-45
	50	DFJ-50
	60	DFJ-60
600 -700 V a.c./ 450 V d.c. (UL)	70	DFJ-70
	80	DFJ-80
	90	DFJ-90
	100	DFJ-100
	110	DFJ-110
	125	DFJ-125
	150	DFJ-150
	175	DFJ-175
	100	DFJ-100
	600 V a.c./ 450 V d.c. (UL)	225
250		DFJ-250
300		DFJ-300
350		DFJ-350
400		DFJ-400
450		DFJ-450
500		DFJ-500
600		DFJ-600

#### Dimensions (in)

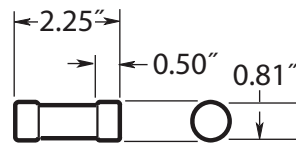

1 to 30 A

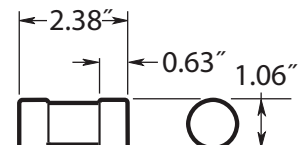

35 to 60 A

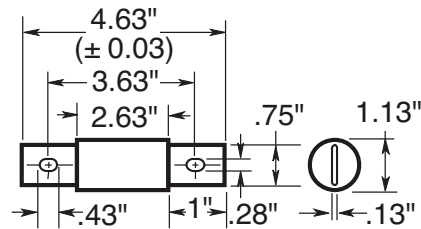

70 to 100 A

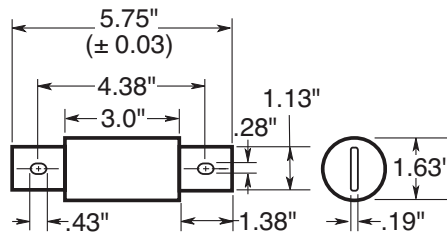

110 to 200 A



**DFJ - Drive fuse links, 600 V a.c. / 450 V d.c. (UL), 1 A to 600 A**

**Dimensions (in)**

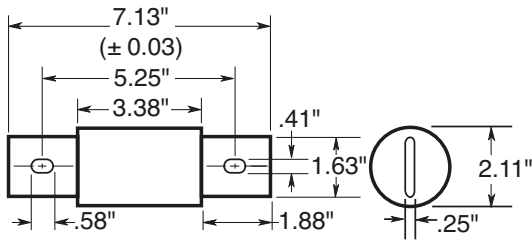

**225 to 400 A**

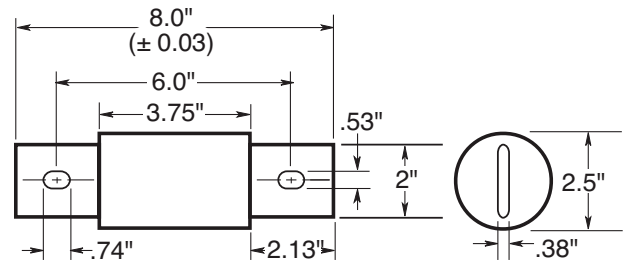

**450 to 600 A**

**Time-current curve - 30 A to 600 A**

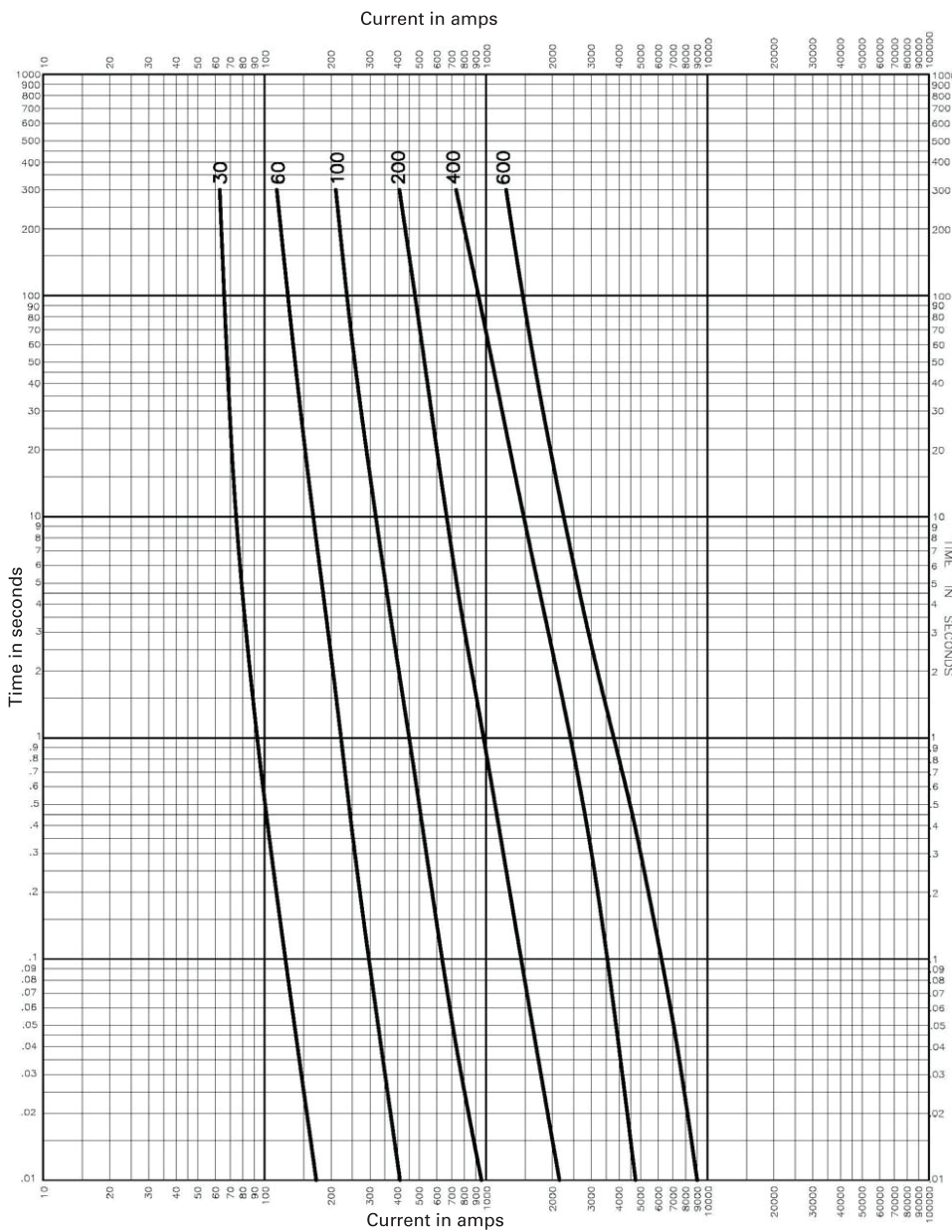

# Square body fuse links

## DFJ - Drive fuse links, 600 V a.c. / 450 V d.c. (UL), 1 A to 600 A

### Cut-off curve - 30 A to 600 A

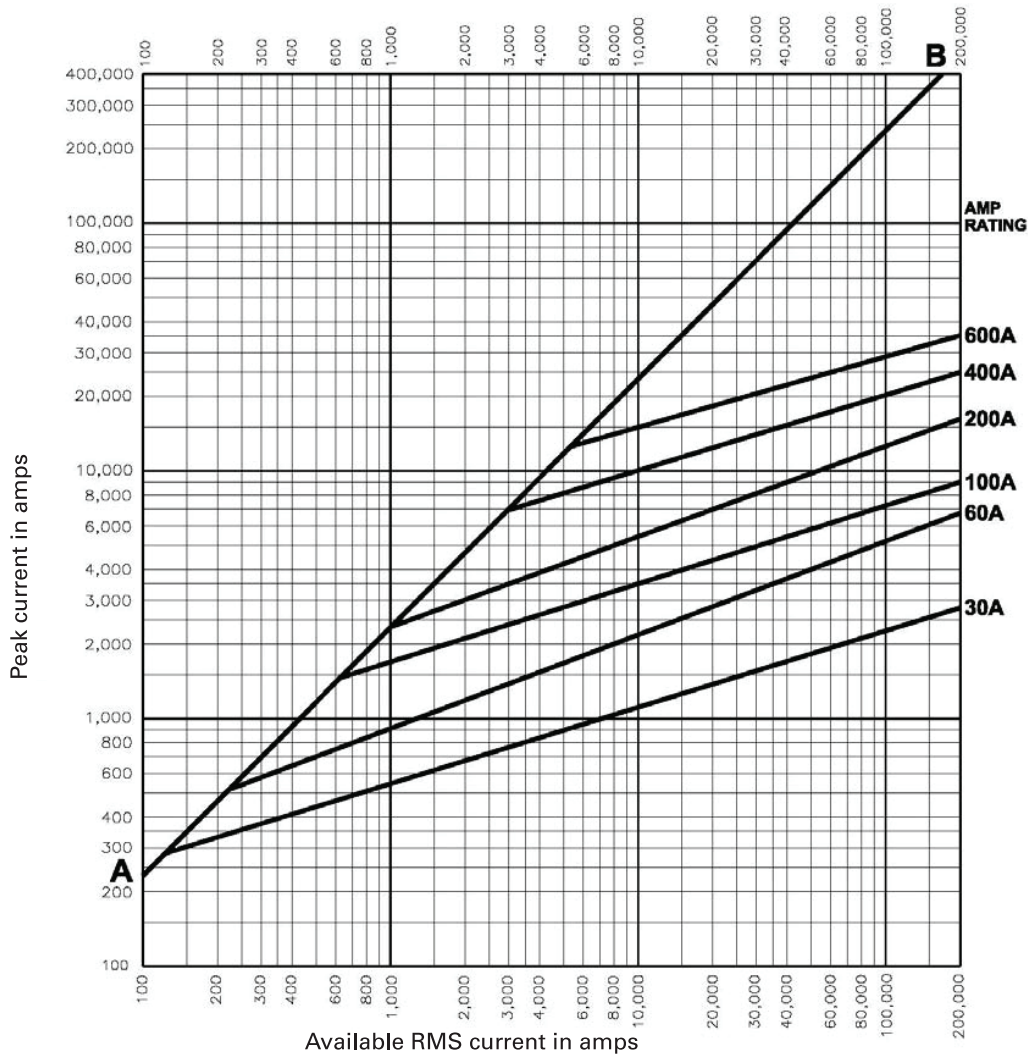

## 170M - Sizes 000 and 230, IGBT fuse links, 750 V d.c. (IEC), 800 V d.c. (UL), 25 A to 630 A

### Specifications

#### Description

Bolted tags high speed fuse links for the protection of IGBT modules, optimised for use in IGBT inverter circuits with DC link rated voltages up to 750 V d.c.. Low inductance  $\leq 15\text{nH}$ .

#### Technical data

- Rated voltage:
  - 750 V d.c. tested at 863V d.c. according to IEC 60269-4
  - 800 V d.c. tested at 800 V d.c. according to UL 248-1
- Rated current: 25 A to 630 A
- Breaking capacity: 50 kA DC (1ms tc) at 800 V d.c.
- Operating class: aR

#### Standards / Agency information

UL DC Recognised, 800 V d.c. L/R 1 mS max



#### Catalogue numbers

Fuse link body size	Rated voltage	Rated current (Amps)	$I^2t$ (A <sup>2</sup> Sec)		Watts loss (W)	Catalogue numbers	
			Pre-arcing			-FU/70	-FN/70
000	750 V d.c. (IEC)	25	25		12	170M1750	170M1730
		32	45		13	170M1751	170M1731
		40	75		14	170M1752	170M1732
		50	135		16	170M1753	170M1733
		63	260		17	170M1754	170M1734
		80	460		20	170M1755	170M1735
		100	795		25	170M1756	170M1736
		125	1300		29	170M1757	170M1737
	800 V d.c. (UL)	160	2550		34	170M1758	170M1738
		200	4350		40	170M1759	170M1739
		250	7400		48	170M1760	170M1740
		315	12,500		60	170M1761	170M1741
		350	17,000		65	170M1762	170M1742
		100	380		35	170M1770	170M1785
		125	645		42	170M1771	170M1786
		160	1350		47	170M1772	170M1787
230	750 V d.c. (IEC)	200	2550		54	170M1773	170M1788
		250	4950		62	170M1774	170M1789
		315	9350		72	170M1775	170M1790
		350	12,000		78	170M1776	170M1791
		400	18,500		80	170M1777	170M1792
	800 V d.c. (UL)	450	27,000		85	170M1778	170M1793
		500	37,500		90	170M1779	170M1794
		550	48,500		95	170M1780	170M1795
		630	69,500		105	170M1781	170M1796

Data sheets: 170K6422 (Size 000), 170K6426 (Size 230)

# Square body fuse links

**170M** - Sizes 000 and 230, IGBT fuse links, 750 V d.c. (IEC), 800 V d.c. (UL), 25 A to 630 A

## Dimensions (mm) - Size 000

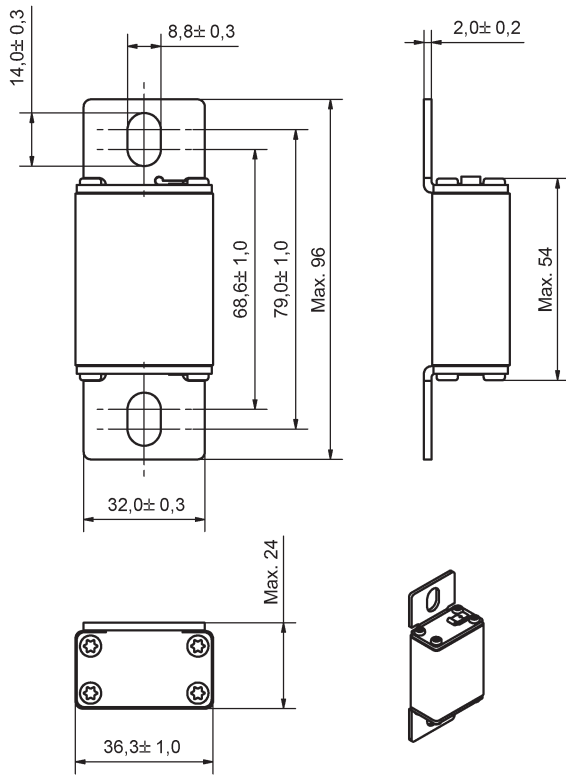

## Dimensions (mm) - Size 230

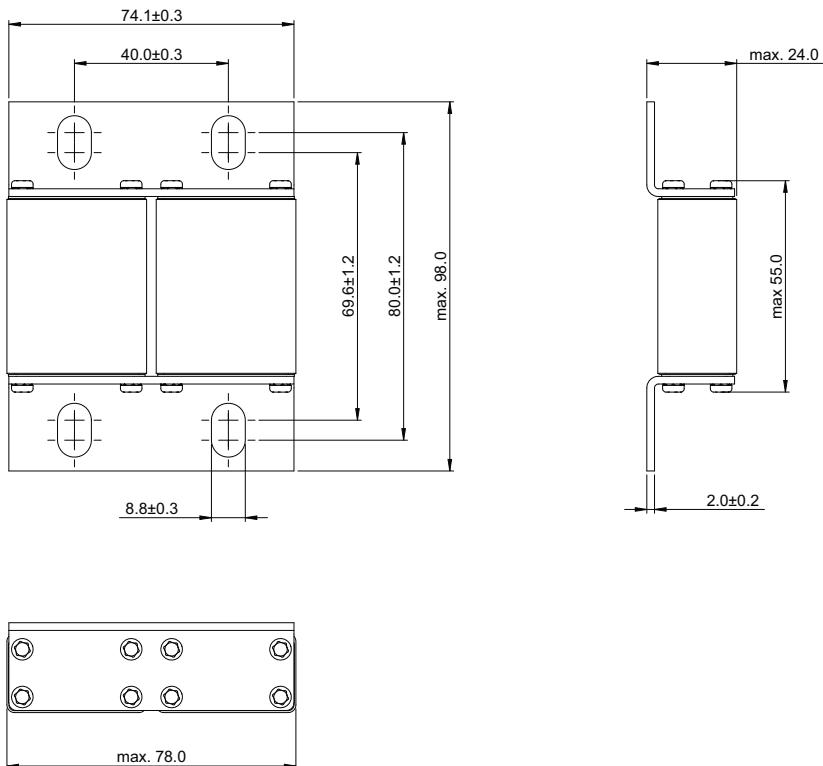

Data sheets: 170K6422 (Size 000), 170K6426 (Size 230)

**170M - Sizes 000 and 230, IGBT fuse links, 750 V d.c. (IEC), 800 V d.c. (UL), 25 A to 630 A**

Time-current curve - Size 000, 25 A to 350 A

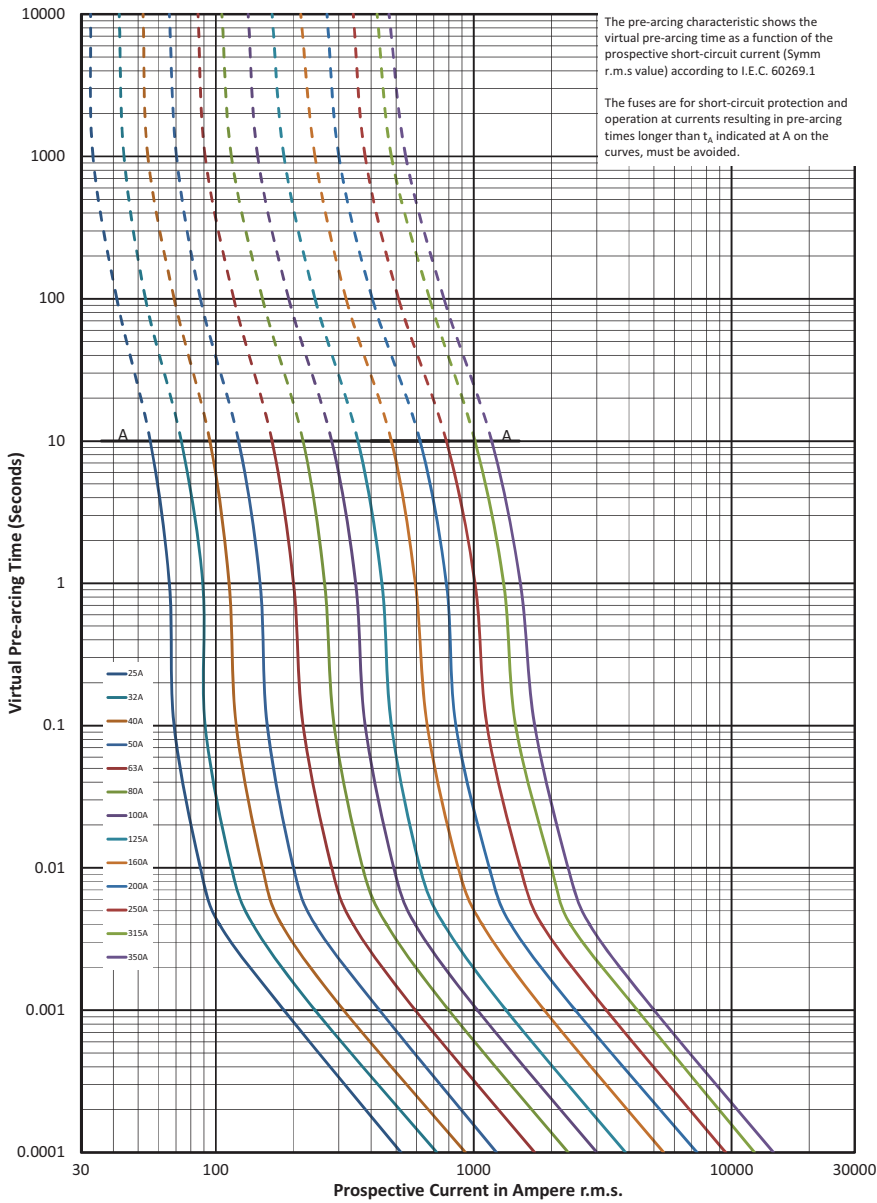

# Square body fuse links

## 170M - Sizes 000 and 230, IGBT fuse links, 750 V d.c. (IEC), 800 V d.c. (UL), 25 A to 630 A

### Cut-off curve - Size 000, 25 A to 350 A

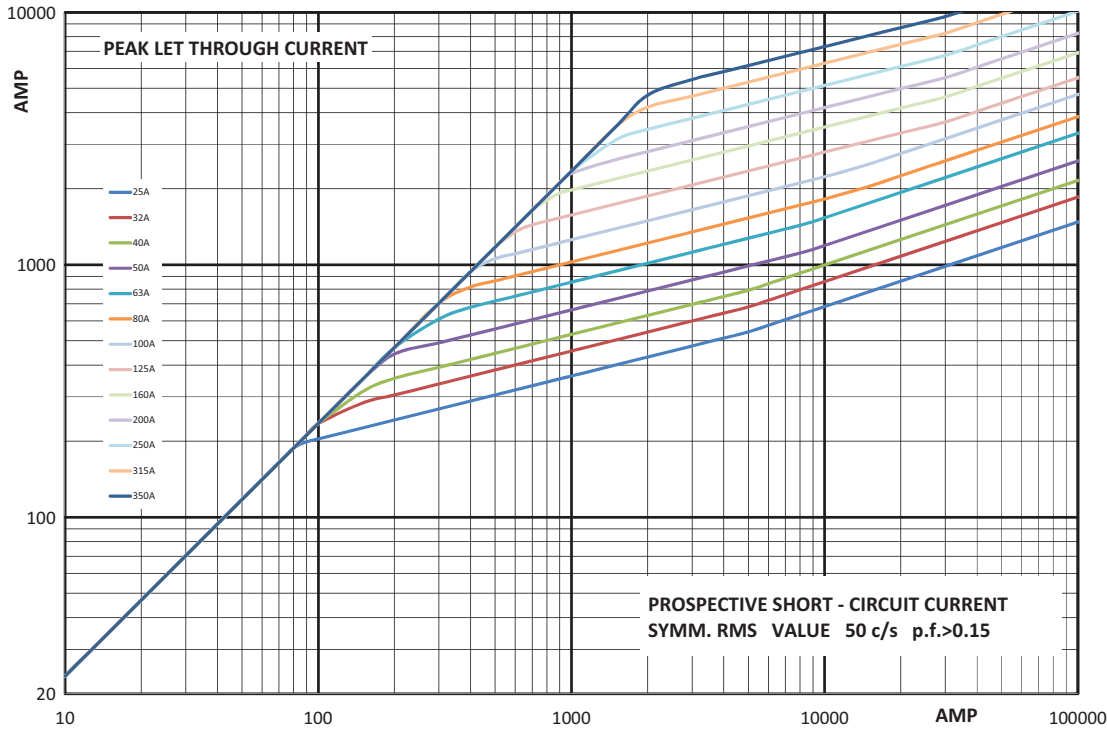

### Total clearing $I^2t$

The total clearing  $I^2t$  at rated voltage and at a power factor of 15 percent are given in the electrical characteristics. For other voltages, the clearing  $I^2t$  is found by multiplying by correction factor,  $K$ , given as a function of applied working voltage,  $E_g$ , (RMS).

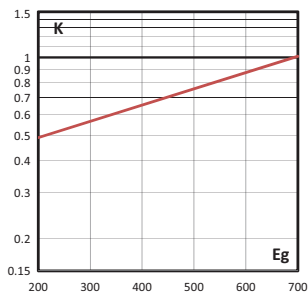

### Arc voltage

This curve gives the peak arc voltage,  $U_L$ , which may appear across the fuse during its operation as a function of the applied working voltage,  $E_g$ , (RMS) at a power factor of 15 percent.

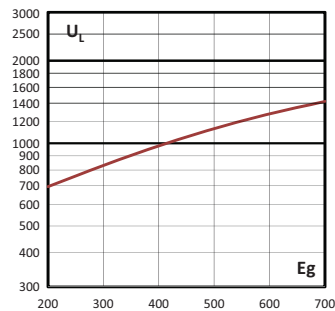

### Watts losses

Watts loss at rated current is given in the electrical characteristics. The curve allows the calculation of the watts losses at load currents lower than the rated current. The correction factor,  $K_p$ , is given as a function of the RMS load current,  $I_b$ , in percent of the rated current.

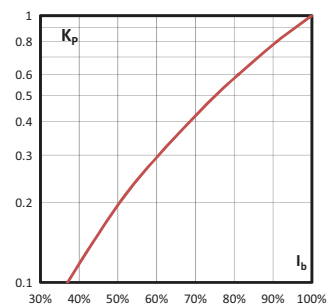

**170M** - Sizes 000 and 230, IGBT fuse links, 750 V d.c. (IEC), 800 V d.c. (UL), 25 A to 630 A

Time-current curve - Size 230, 100 A to 630 A

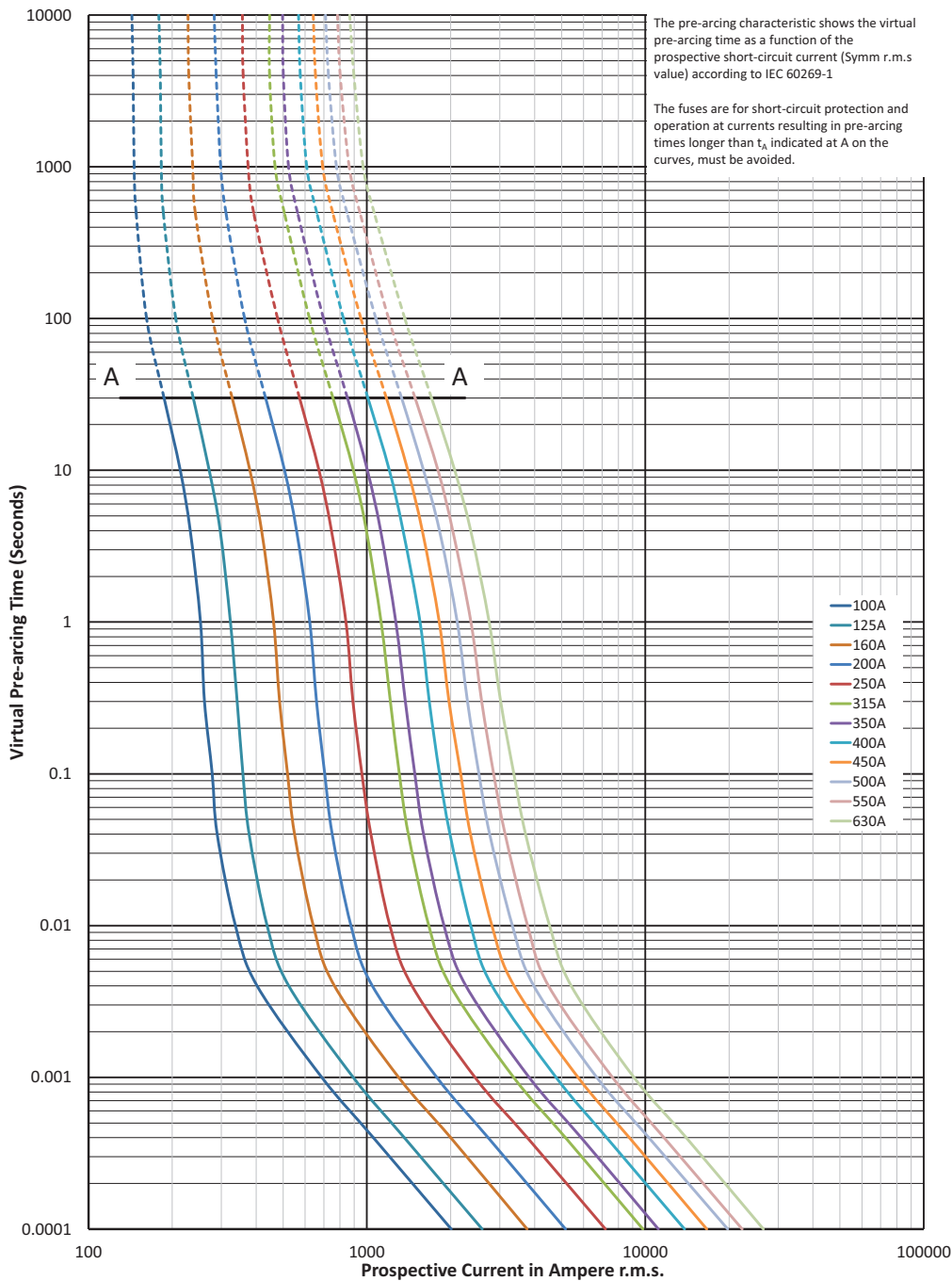

# Square body fuse links

## 170M - Sizes 000 and 230, IGBT fuse links, 750 V d.c. (IEC), 800 V d.c. (UL), 25 A to 630 A

### Cut-off curve - Size 230, 100 A to 630 A

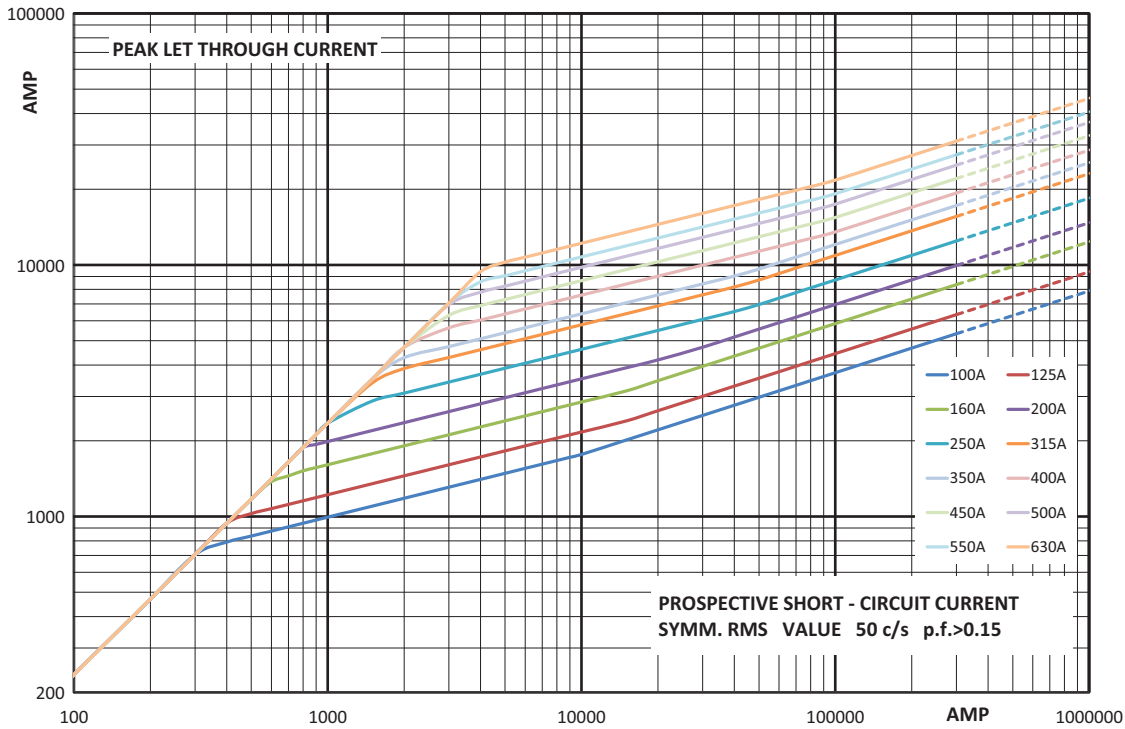

### Total clearing I<sup>2</sup>t

The total clearing I<sup>2</sup>t at rated voltage and at a power factor of 15 percent are given in the electrical characteristics. For other voltages, the clearing I<sup>2</sup>t is found by multiplying by correction factor, K, given as a function of applied working voltage, E<sub>g</sub>, (RMS).

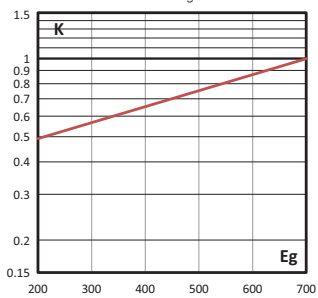

### Arc voltage

This curve gives the peak arc voltage, U<sub>L</sub>, which may appear across the fuse during its operation as a function of the applied working voltage, E<sub>g</sub>, (RMS) at a power factor of 15 percent.

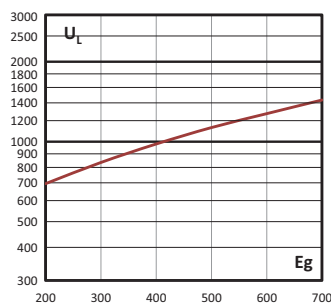

### Watts losses

Watts loss at rated current is given in the electrical characteristics. The curve allows the calculation of the watts losses at load currents lower than the rated current. The correction factor, K<sub>p</sub>, is given as a function of the RMS load current, I<sub>b</sub>, in percent of the rated current.

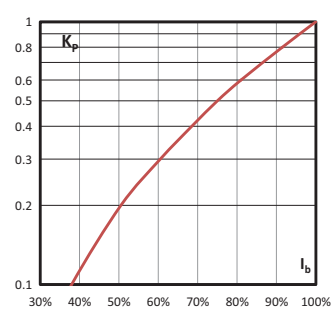



## 170M - Sizes 000 and 230, IGBT fuse links, 1000 V d.c. (IEC and UL), 25 A to 500 A

### Specifications

#### Description

High speed bolted tags high speed fuse links for the protection of IGBT modules, optimised for use in IGBT inverter circuits with DC link rated voltages up to 1000 V d.c.. Low inductance  $\leq 20\text{nH}$ .

#### Technical data

- Rated voltage: 1000 V d.c. tested at 1000 V d.c. according to UL 248-1
- Rated current: 25 A to 500 A
- Breaking capacity: 50 kA DC (1ms tc UL)
- Operating class: aR

#### Standards / Agency information

UL DC Recognised, 1000 V d.c. L/R 1mS max.

CE



#### Catalogue numbers

Fuse link body size	Rated voltage	Rated current (Amps)	$I^2t$ (A <sup>2</sup> Sec)		Watts loss (W)	Catalogue numbers		
			Pre-arcing			-FU/90	-FN/90	
000	1000 V d.c. (UL)	25	19	14	170M1802	170M1842		
		32	34	17	170M1803	170M1843		
		40	61	20	170M1804	170M1844		
		50	135	21	170M1805	170M1845		
		63	245	22	170M1806	170M1846		
		80	505	27	170M1807	170M1847		
		100	1050	32	170M1808	170M1848		
		125	1900	34	170M1809	170M1849		
		160	4050	37	170M1810	170M1850		
		200	8500	43	170M1811	170M1851		
		225	12,000	45	170M1812	170M1852		
		250	16,000	48	170M1813	170M1853		
		230	1000 V d.c. (UL)	100	600	38	170M1824	170M1860
				125	1200	42	170M1825	170M1861
160	2550			48	170M1826	170M1862		
200	4650			55	170M1827	170M1863		
250	9300			62	170M1828	170M1864		
315	18,500			68	170M1829	170M1865		
350	24,500			75	170M1830	170M1866		
400	37,500			80	170M1831	170M1867		
450	52,000			85	170M1832	170M1868		
500	69,500			90	170M1833	170M1869		

Data sheets: 170K6680 (Size 000), 170K6682 (Size 230)

# Square body fuse links

## 170M - Sizes 000 and 230, IGBT fuse links, 1000 V d.c. (IEC and UL), 25 A to 500 A

### Dimensions (mm) - Size 000

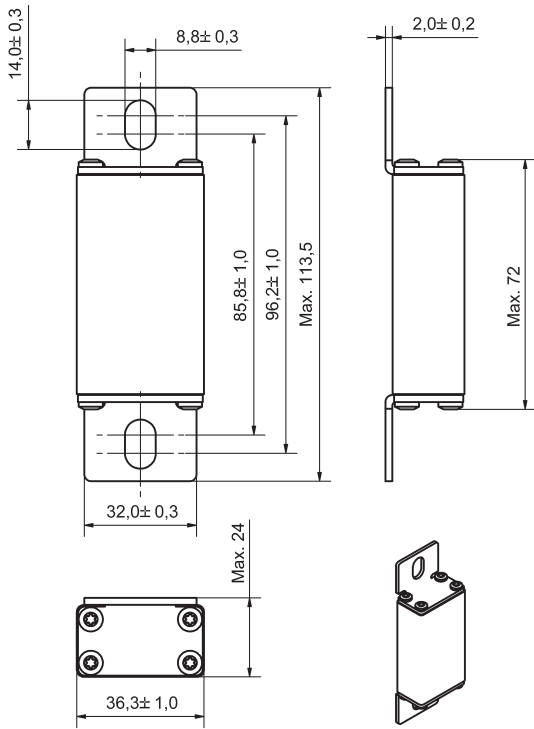

### Dimensions (mm) - Size 230

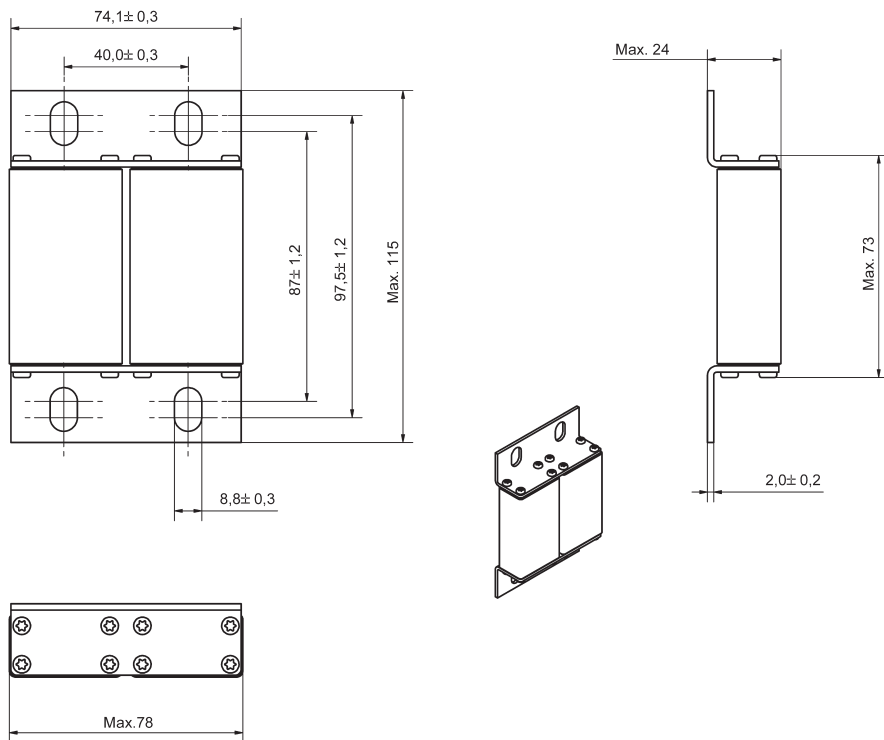

Data sheets: 170K6680 (Size 000), 170K6682 (Size 230)

**170M - Sizes 000 and 230, IGBT fuse links, 1000 V d.c. (IEC and UL), 25 A to 500 A**

Time-current curve - Size 000, 25 A to 250 A

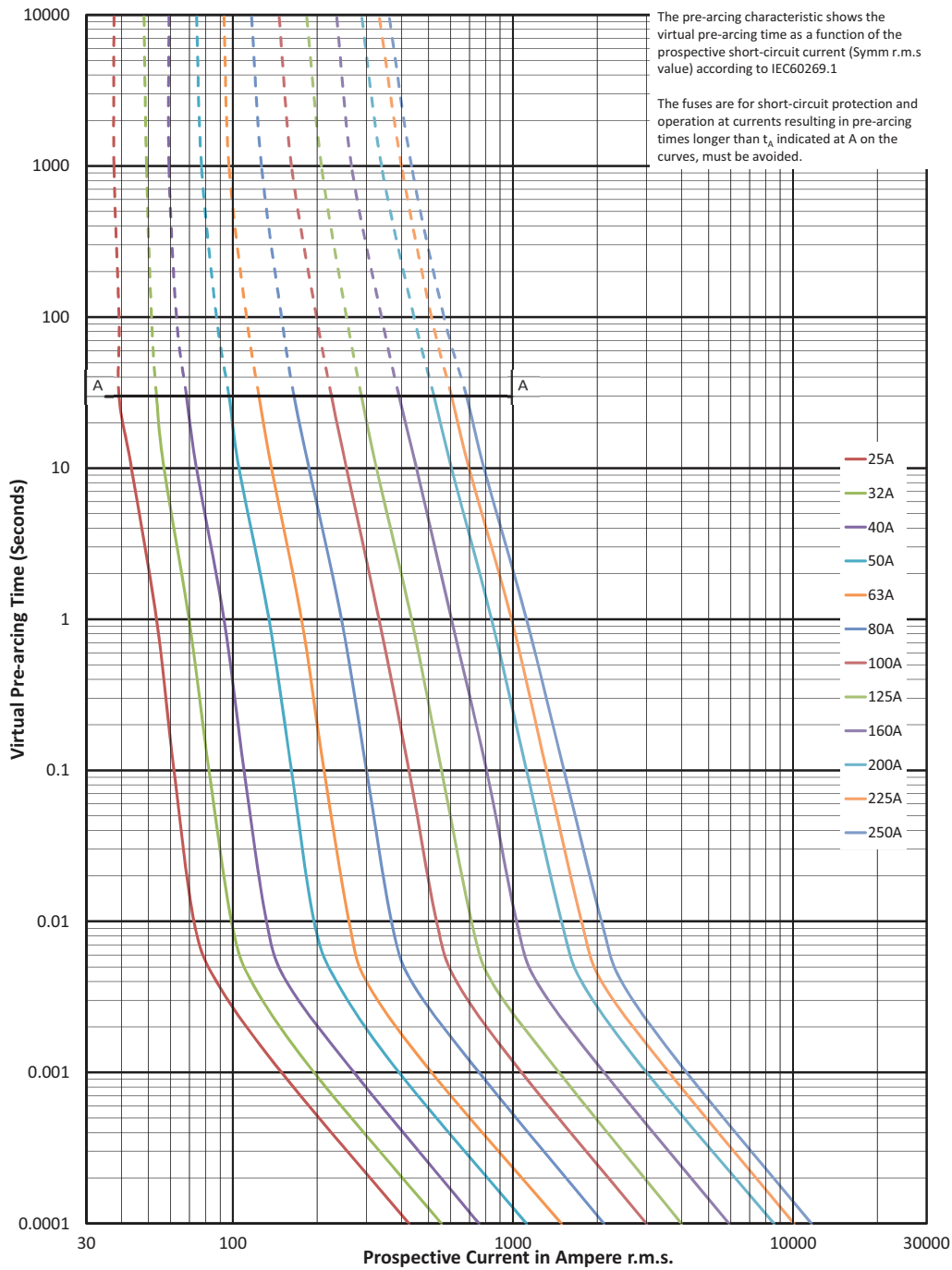

Data sheets: 170K6680 (Size 000), 170K6682 (Size 230)

# Square body fuse links

## 170M - Sizes 000 and 230, IGBT fuse links, 1000 V d.c. (IEC and UL), 25 A to 500 A

### Cut-off curve - Size 000, 25 A to 250 A

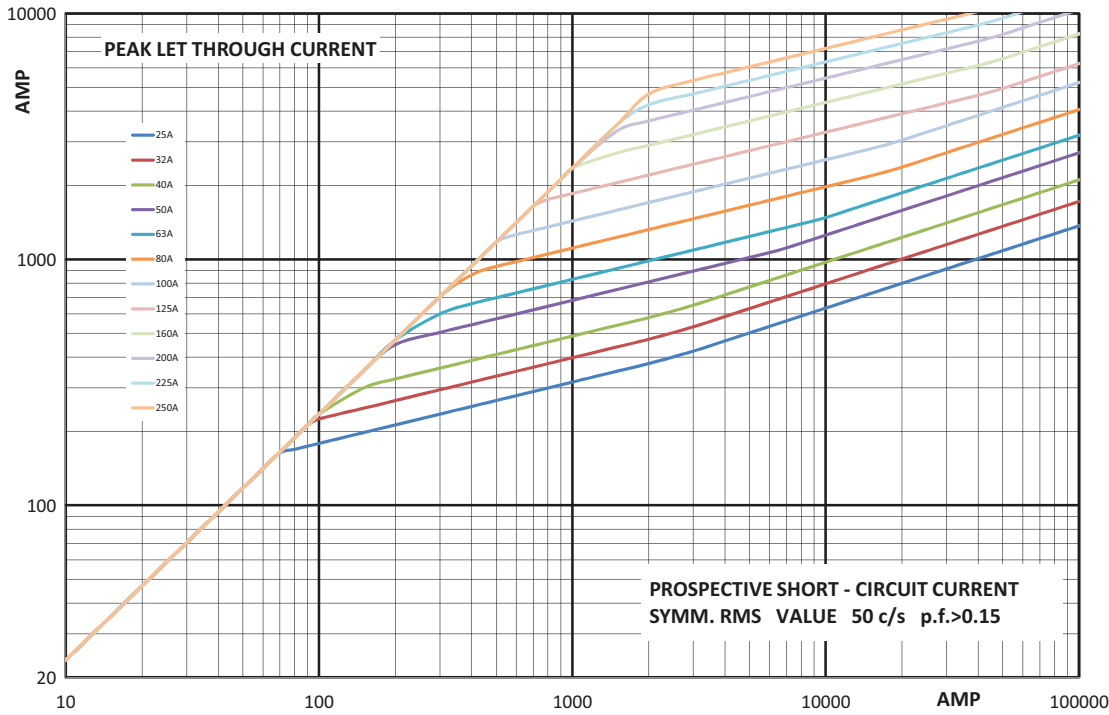

### Total clearing $I^2t$

The total clearing  $I^2t$  at rated voltage and at a power factor of 15 percent are given in the electrical characteristics. For other voltages, the clearing  $I^2t$  is found by multiplying by correction factor,  $K$ , given as a function of applied working voltage,  $E_g$ , (RMS).

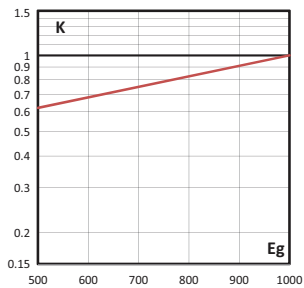

### Arc voltage

This curve gives the peak arc voltage,  $U_L$ , which may appear across the fuse during its operation as a function of the applied working voltage,  $E_g$ , (RMS) at a power factor of 15 percent.

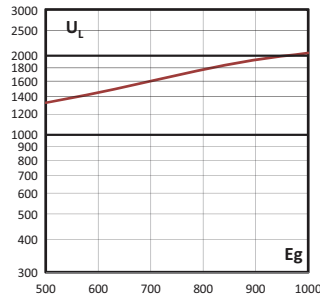

### Watts losses

Watts loss at rated current is given in the electrical characteristics. The curve allows the calculation of the watts losses at load currents lower than the rated current. The correction factor,  $K_p$ , is given as a function of the RMS load current,  $I_b$ , in percent of the rated current.

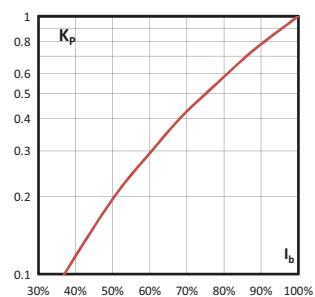

**170M - Sizes 000 and 230, IGBT fuse links, 1000 V d.c. (IEC and UL), 25 A to 500 A**

**Time-current curve - Size 230, 100 A to 500 A**

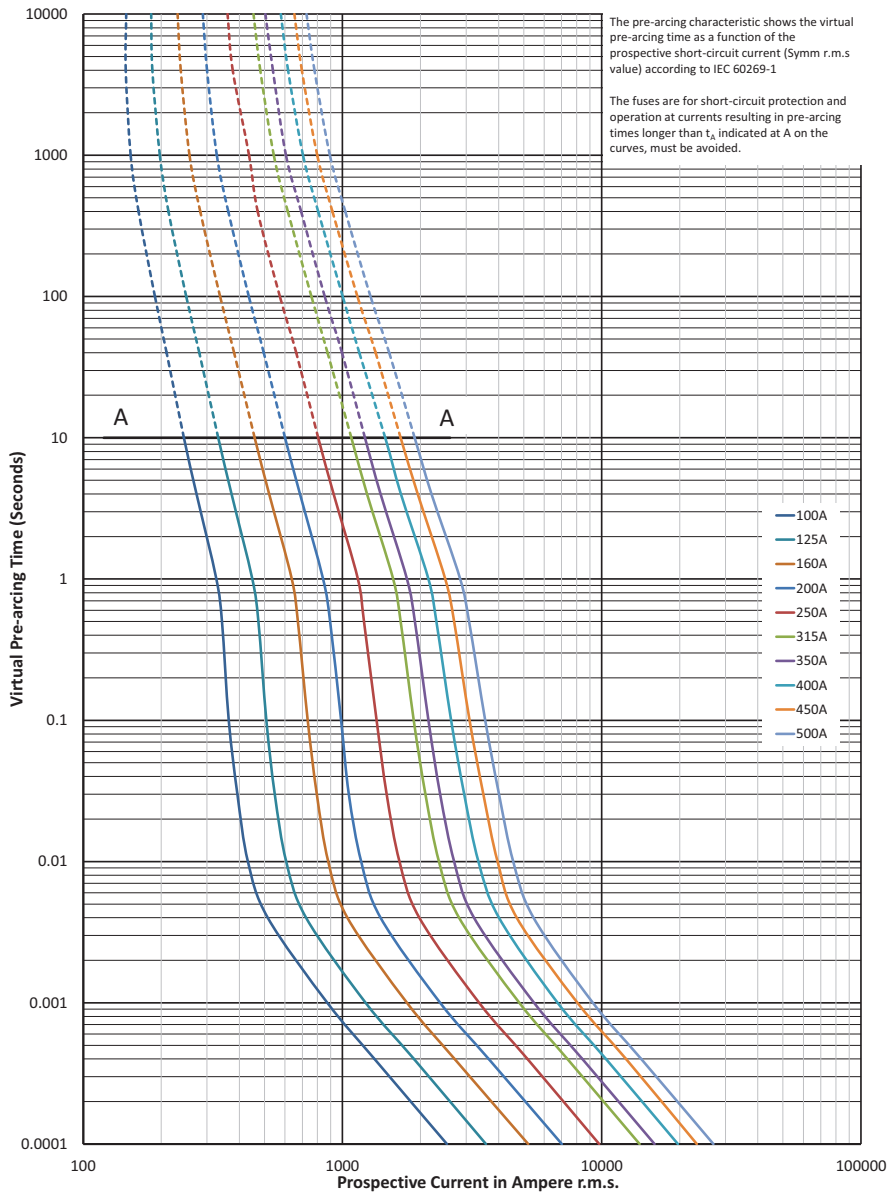

Data sheets: 170K6680 (Size 000), 170K6682 (Size 230)

# Square body fuse links

## 170M - Sizes 000 and 230, IGBT fuse links, 1000 V d.c. (IEC and UL), 25 A to 500 A

### Cut-off curve - Size 230, 100 A to 500 A

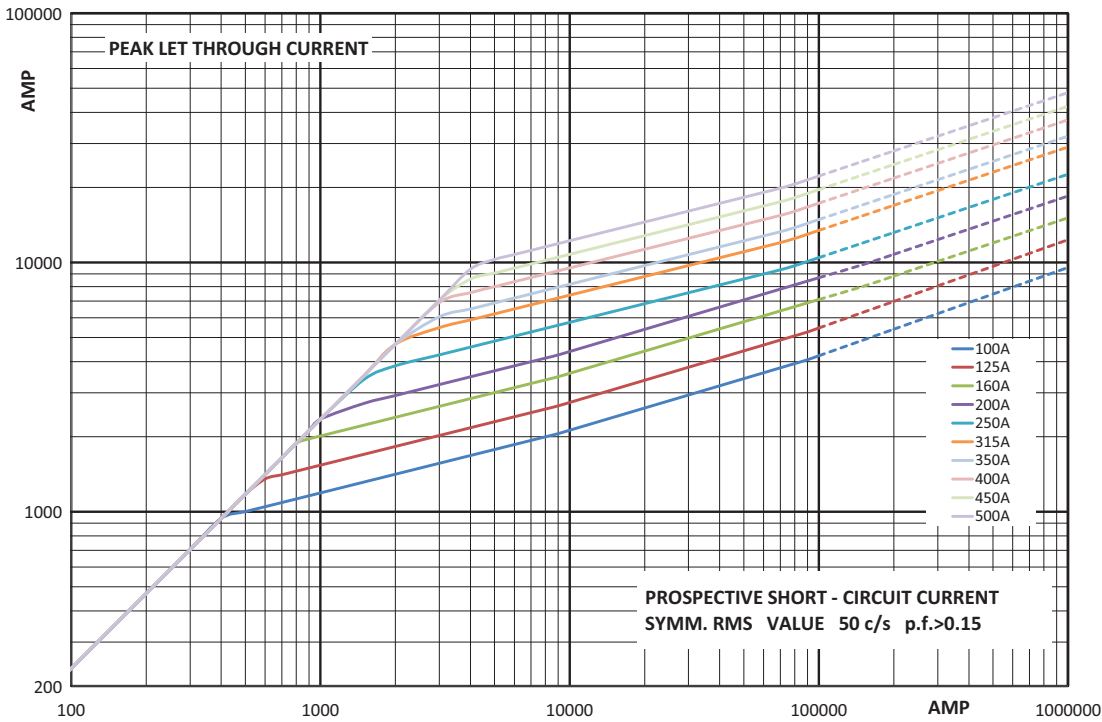

### Total clearing $I^2t$

The total clearing  $I^2t$  at rated voltage and at a power factor of 15 percent are given in the electrical characteristics. For other voltages, the clearing  $I^2t$  is found by multiplying by correction factor,  $K$ , given as a function of applied working voltage,  $E_g$ , (RMS).

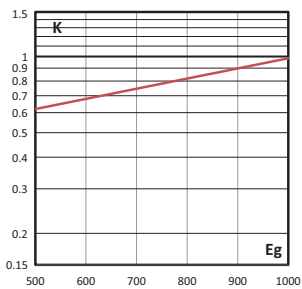

### Arc voltage

This curve gives the peak arc voltage,  $U_L$ , which may appear across the fuse during its operation as a function of the applied working voltage,  $E_g$ , (RMS) at a power factor of 15 percent.

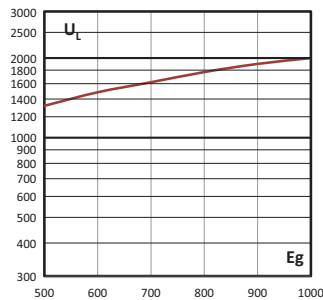

### Watts losses

Watts loss at rated current is given in the electrical characteristics. The curve allows the calculation of the watts losses at load currents lower than the rated current. The correction factor,  $K_p$ , is given as a function of the RMS load current,  $I_b$ , in percent of the rated current.

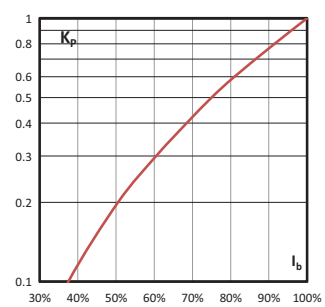

## 170M - Sizes 1\*, 3 and 23, Square body fuse links, 750 V d.c. (IEC), 50 A to 1600 A

### Specifications

#### Description

Traction flush end square body high speed fuse links for superior protection of DC third rail applications up to 750 V d.c.

#### Technical data

- Rated voltage: 750 V d.c. (IEC)
- Rated current: 50 A to 1600 A
- Breaking capacity: see details in table below
- Operating class:
  - aR size 1\*
  - gR: size 1\* (at 900 V d.c.), 3 and 23

#### Standards / Agency information

IEC 60269



#### Catalogue numbers

Fuse link type	Fuse link body size	Rated voltage	Rated current (Amps)	Breaking capacity	I <sup>2</sup> t (A <sup>2</sup> Sec)		Watts loss (W)		Catalogue numbers
					Pre-arcing	Clearing at 750 V d.c.	0.8 I <sub>n</sub>	I <sub>n</sub>	
Flush end	1*	750 V d.c. / 900 V d.c. (IEC)	50	80 kA at 750 V d.c. L/R 65 ms	390	1300	15	27	170M2000
			63		610	2050	18	35	170M2001
			80		670	2250	19	37	170M2002
			100		2450	8150	21	40	170M2003
			125		2950	9800	24	47	170M2004
			160		5500	18,250	29	56	170M2005
Flush end	3	750 V d.c. (IEC)	450	100 kA at 700 V d.c. L/R 100 ms	65,700	272,300	46	87	170M2010
			500		83,200	344,800	52	98	170M2011
			550		136,700	566,500	67	126	170M2012
			630		173,500	719,000	75	142	170M2013
			700		268,000	1,110,500	78	156	170M2014
			750		307,600	1,275,000	83	167	170M2015
			800		349,900	1,450,000	89	178	170M2016
Parallel	23	800 V d.c. (IEC/ UL)	1000	100 kA at 800 V d.c., L/R 40 ms	476,300	1,973,700	112	187	170M2017
			1250		694,000	2,875,800	134	224	170M2018
			1400		1,071,600	4,440,500	152	254	170M2019
			1500		1,230,200	5,097,700	165	275	170M2020
			1600		1,399,700	5,800,100	180	300	170M2021

# Traction fuse links

## 170M - Sizes 1\*, 3 and 23, Square body fuse links, 750 V d.c. (IEC), 50 A to 1600 A

Dimensions (mm) - Size 1\*, 170M2000 to 170M2005, Flush end

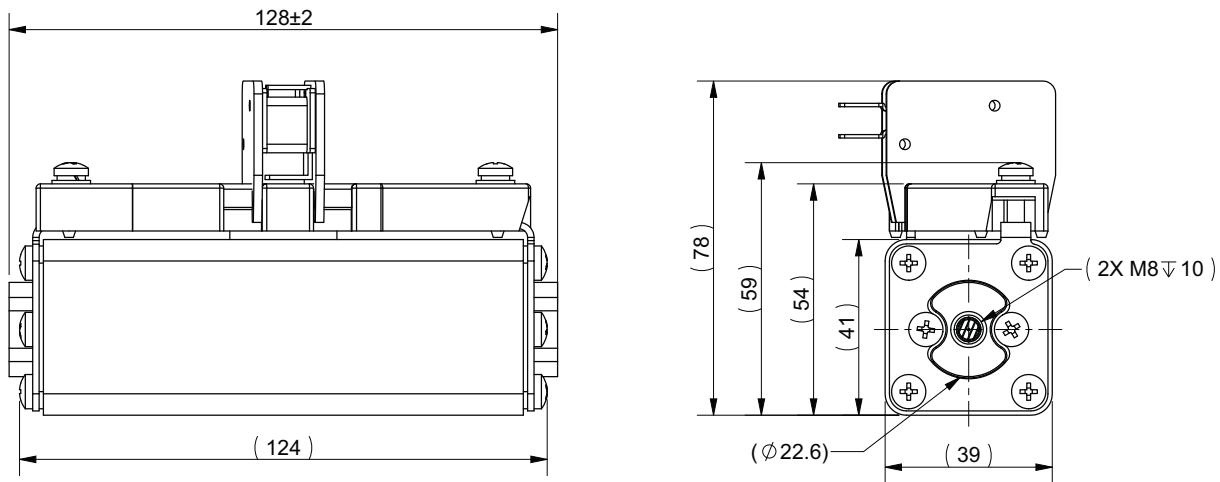

Dimensions (mm) - Size 3, 170M2010 to 170M2016, Flush end

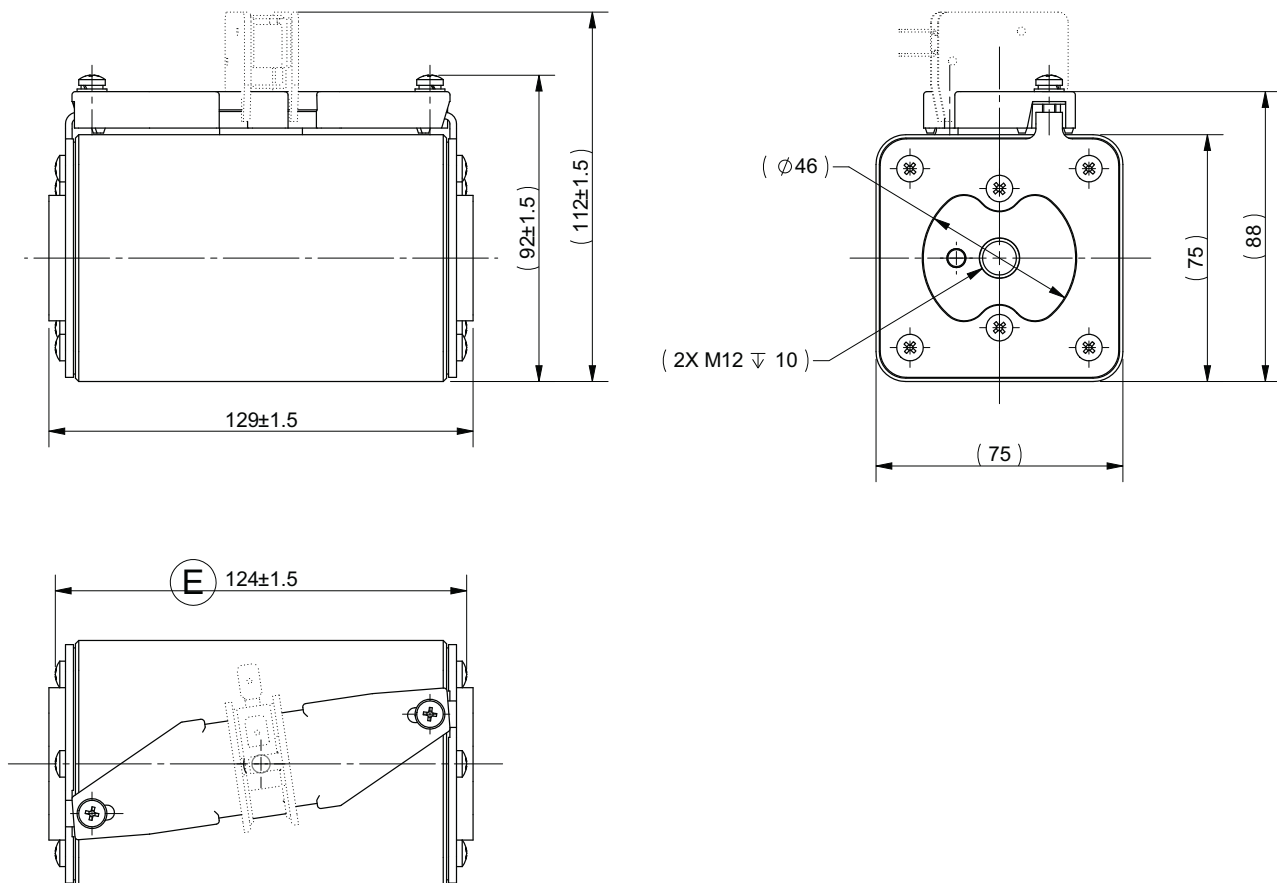

Data sheets: 720140, size 1\* 5785524, 3 5785521, 23 5785525



**170M** - Sizes 1\*, 3 and 23, Square body fuse links, 750 V d.c. (IEC), 50 A to 1600 A

Dimensions (mm) - Size 23, 170M2017 to 170M2021, Parallel

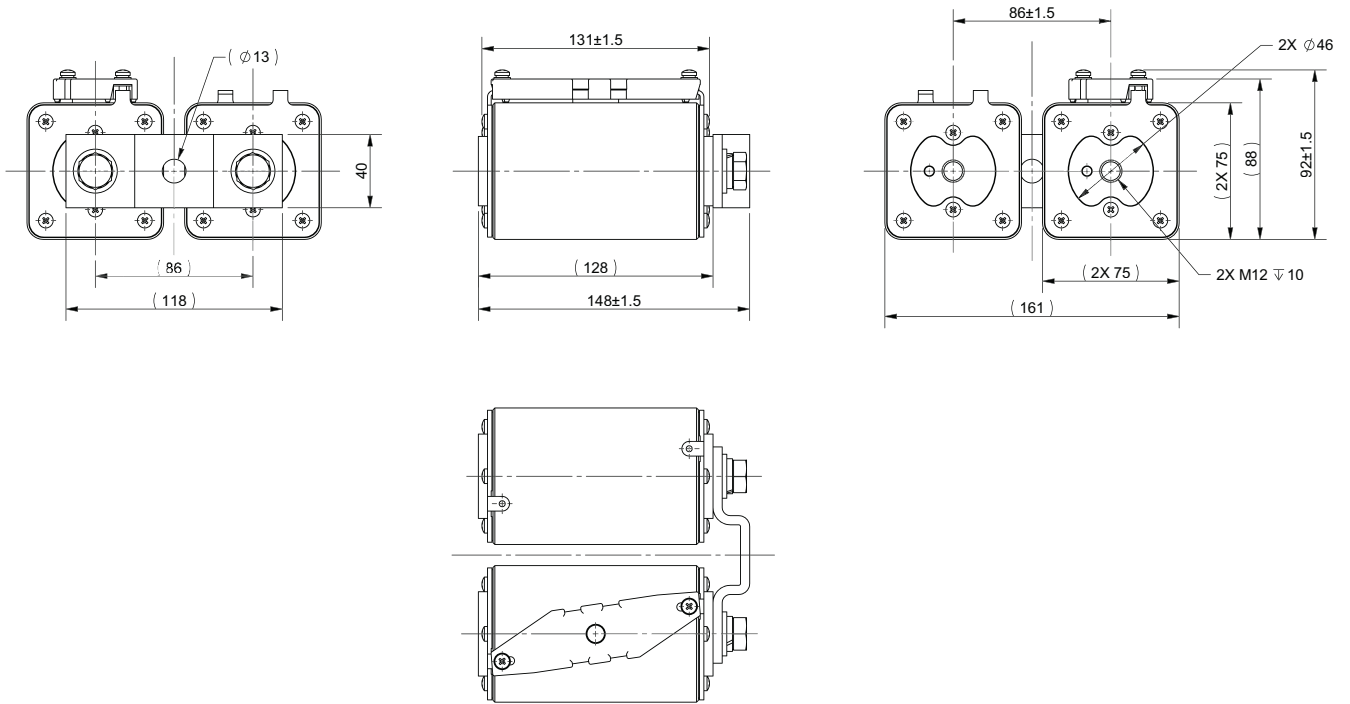

Time-current curve - 170M2000 to 170M2005, 50 A to 160 A

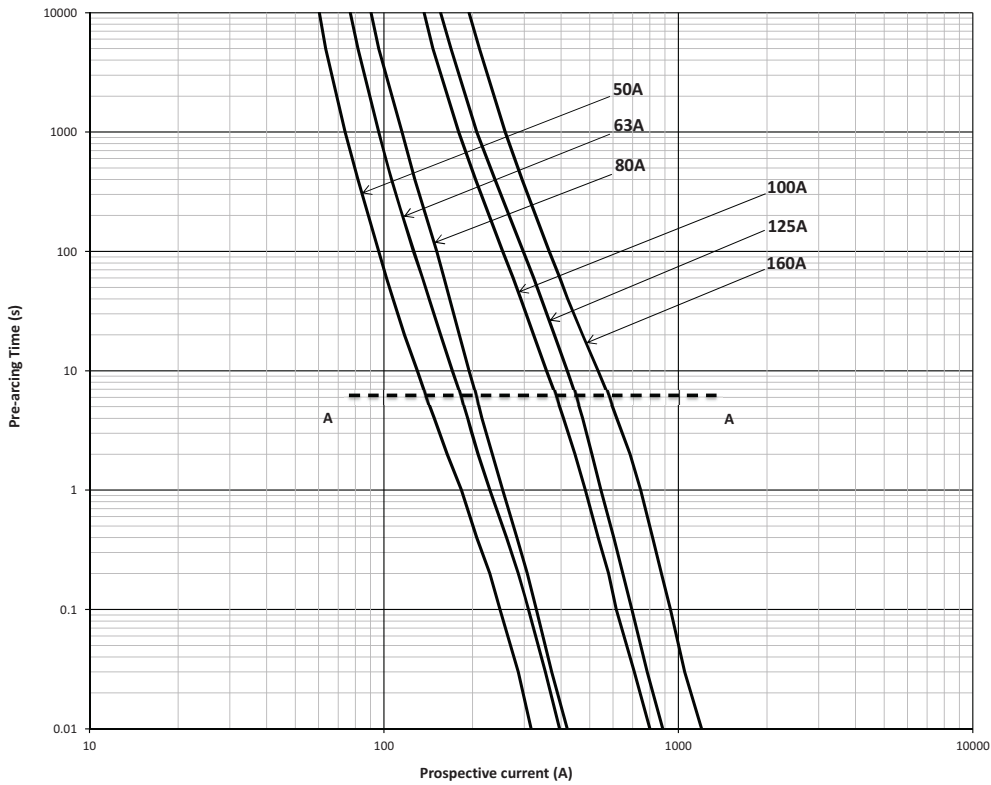

Data sheets: 720140, size 1\* 5785524, 3 5785521, 23 5785525

# Traction fuse links

## 170M - Sizes 1\*, 3 and 23, Square body fuse links, 750 V d.c. (IEC), 50 A to 1600 A

Time-current curve - 170M2010 to 170M2016, 450 A to 800 A

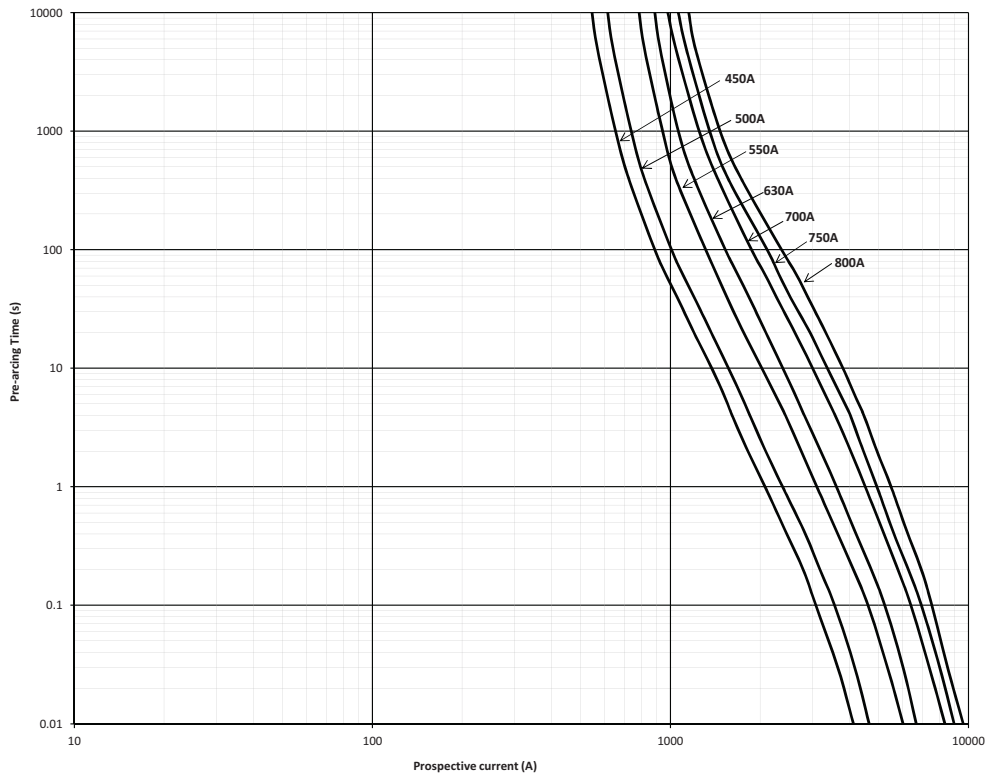

Time-current curve - 170M2017 to 170M2021, 1000 A to 1600 A

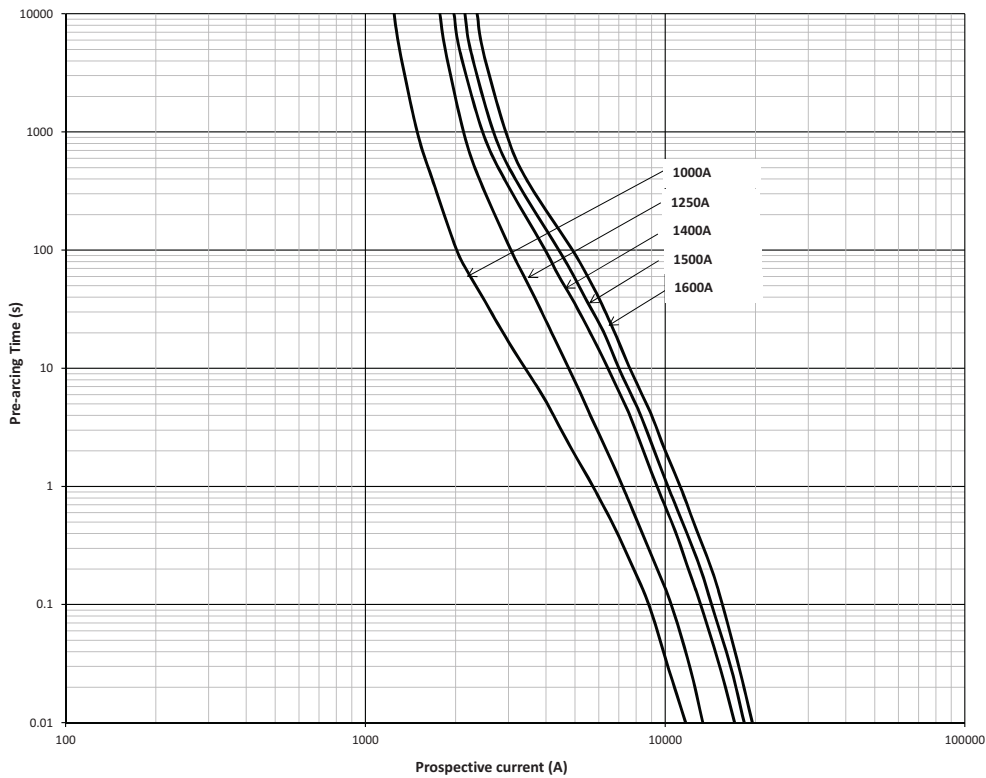

**170E - Sizes 1\*, 1, 2 and 3, Square body fuse links, 750 V d.c. (IEC), 63 A to 500 A****Specifications****Description**

Traction flush end square body high speed fuse links for superior protection of DC third rail applications up to 750 V d.c..

**Technical data**

- Rated voltage: 750 V d.c. (IEC)
- Rated current: 63 A to 500 A
- Breaking capacity: see details below
- Operating class: gR

**Standards / Agency information**

Consult Eaton [bulehighspeedtechnical@eaton.com](mailto:bulehighspeedtechnical@eaton.com)

**Catalogue numbers**

Fuse link body size	Rated voltage	Breaking capacity	Rated current (Amps)	$I^2t$ (A <sup>2</sup> s) Pre-arcing	Watts loss (W)	Catalogue numbers		Fuse link type
						-BK flush end	-EK knife blade	
1*	750 V d.c. (IEC)	80 kA at 43ms	63	1100	10	170E3577	170E3583	EK/155
			80	1750	13	170E3578	170E3584	
			100	3000	16	170E3579	170E3585	
			125	4500	21	170E3580	170E3586	
			160	7700	26	170E3581	170E3587	
1	750 V d.c. (IEC)	50 kA at 15ms	200	11,000	37	170E5417	170E5420	EK/165
			250	18,000	46	170E5418	170E5421	
			250	17,000	47	170E8335	170E8345	
2	750 V d.c. (IEC)	100 kA at 15ms	315	28,000	57	170E8336	170E8346	EK/170
			400	55,000	73	170E8337	170E8347	
3	750 V d.c. (IEC)	50 kA at 15 ms	500	75,500	93	170E9681	170E9685	EK/170

Data sheets: 170K3620 (size 1\*), 170k3622 (size 1), 170K3624 (size 2), 170K3626-A (size 3)

## Traction fuse links

### 170E - Sizes 1\*, 1, 2 and 3, Square body fuse links, 750 V d.c. (IEC), 63 A to 500 A

#### Dimensions (mm) - BK/130

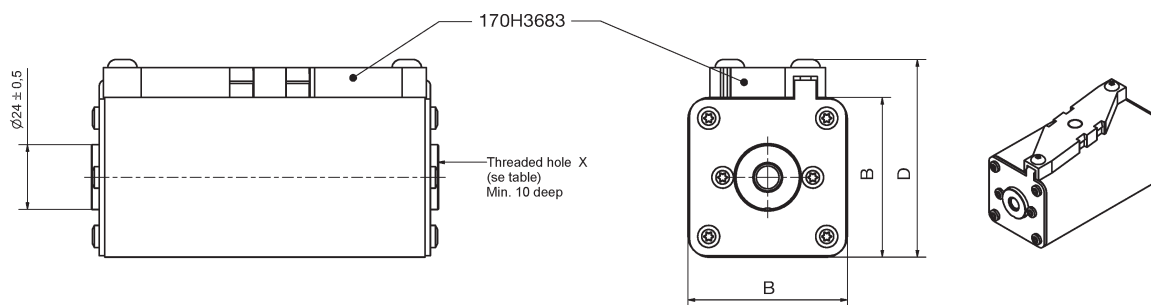

Size	A	B	D	X
1*BK/130	129	43	61	M8
1 BK/130	130	51	69	M8
2 BK/130	130	59	77	M10
3 BK/130	131	74	90	M12

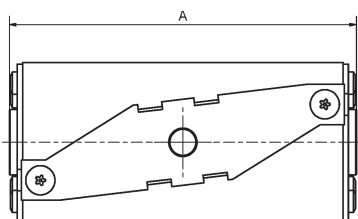

#### Dimensions (mm) - EK/

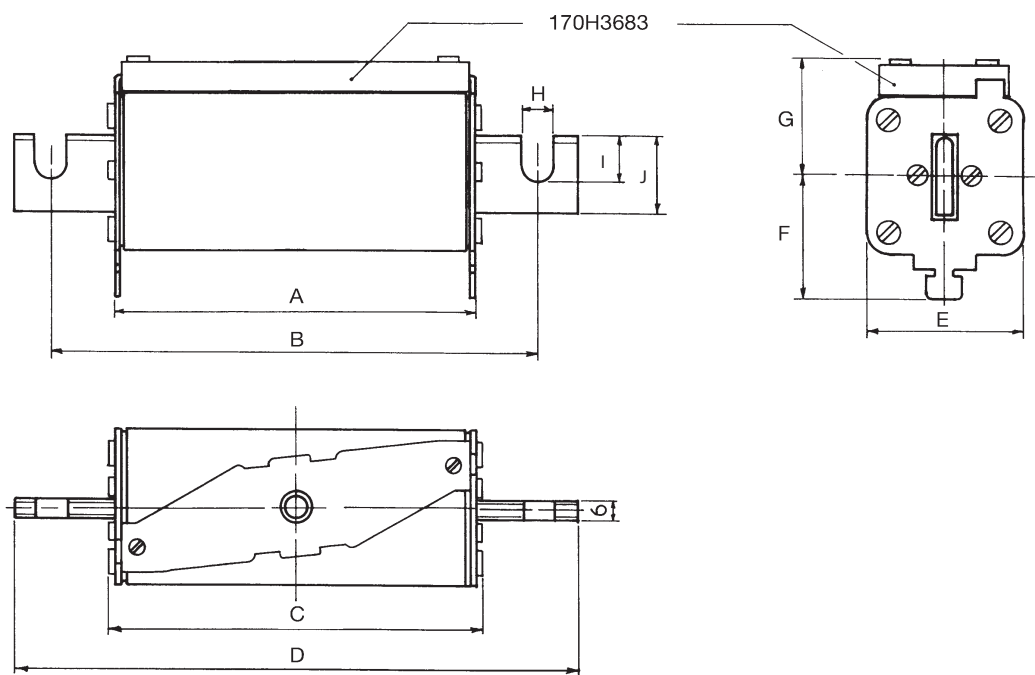

Size	A	B	C	D	E	F	G	H	I	J
1*EK/155	124	156	129	180	43	36	41	9	9	18
1 EK/165	124	166	129	191	51	37	41	11	14	25
2 EK/170	124	170	129	205	59	42	48	13	21	30
3 EK/170	125	170	130	206	74	51	56	13	20	36

Data sheets: 170K3620 (size 1\*), 170k3622 (size 1), 170K3624 (size 2), 170K3626-A (size 3)

**170E - Sizes 1\*, 1, 2 and 3, Square body fuse links, 750 V d.c. (IEC), 63 A to 500 A**

Time-current curve - Size 1\*, 63 A to 160 A

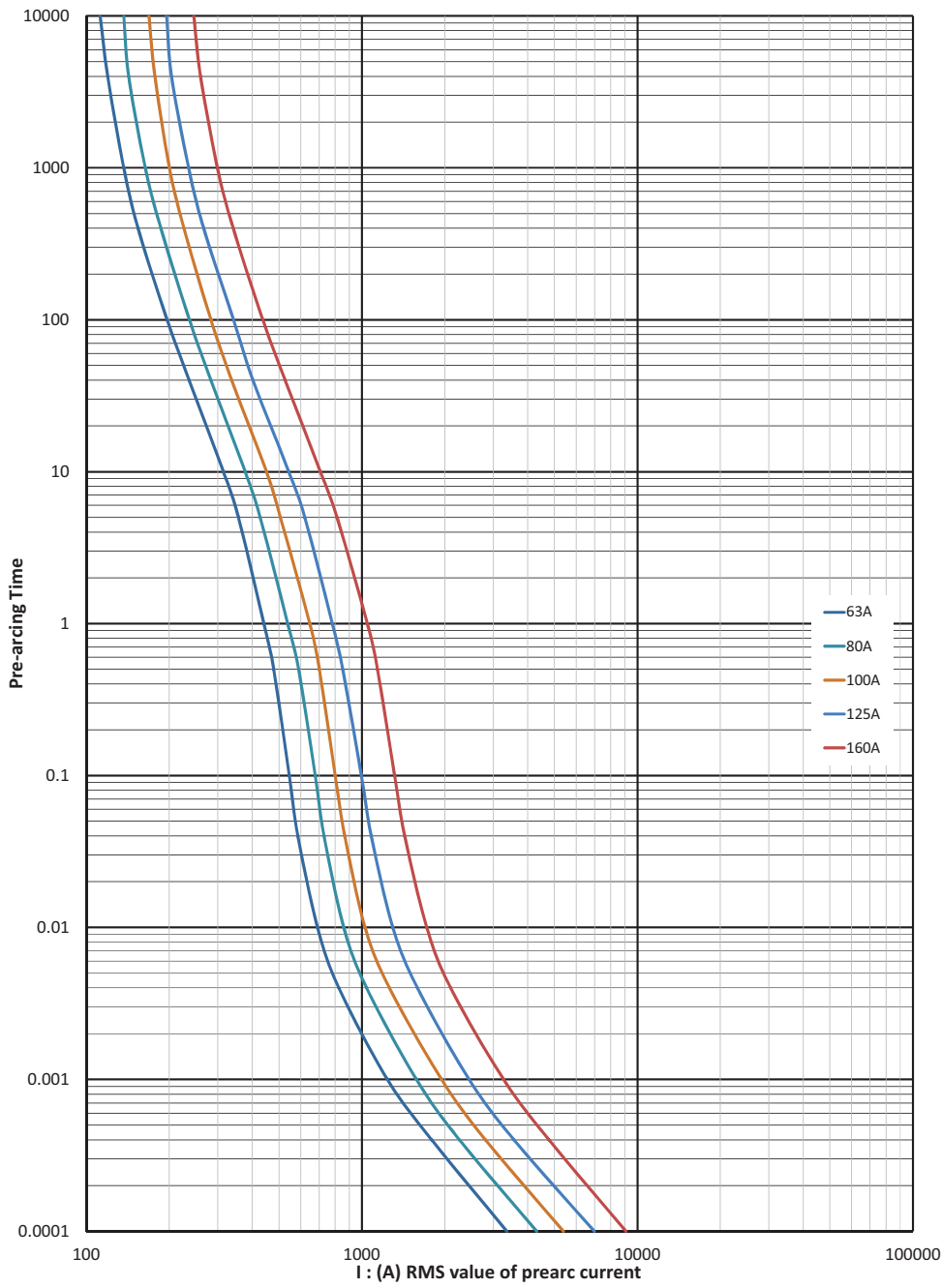

Data sheets: 170K3620 (size 1\*), 170k3622 (size 1), 170K3624 (size 2), 170K3626-A (size 3)

# Traction fuse links

## 170E - Sizes 1\*, 1, 2 and 3, Square body fuse links, 750 V d.c. (IEC), 63 A to 500 A

### Cut-off curve - Size 1\*, 63 A to 160 A

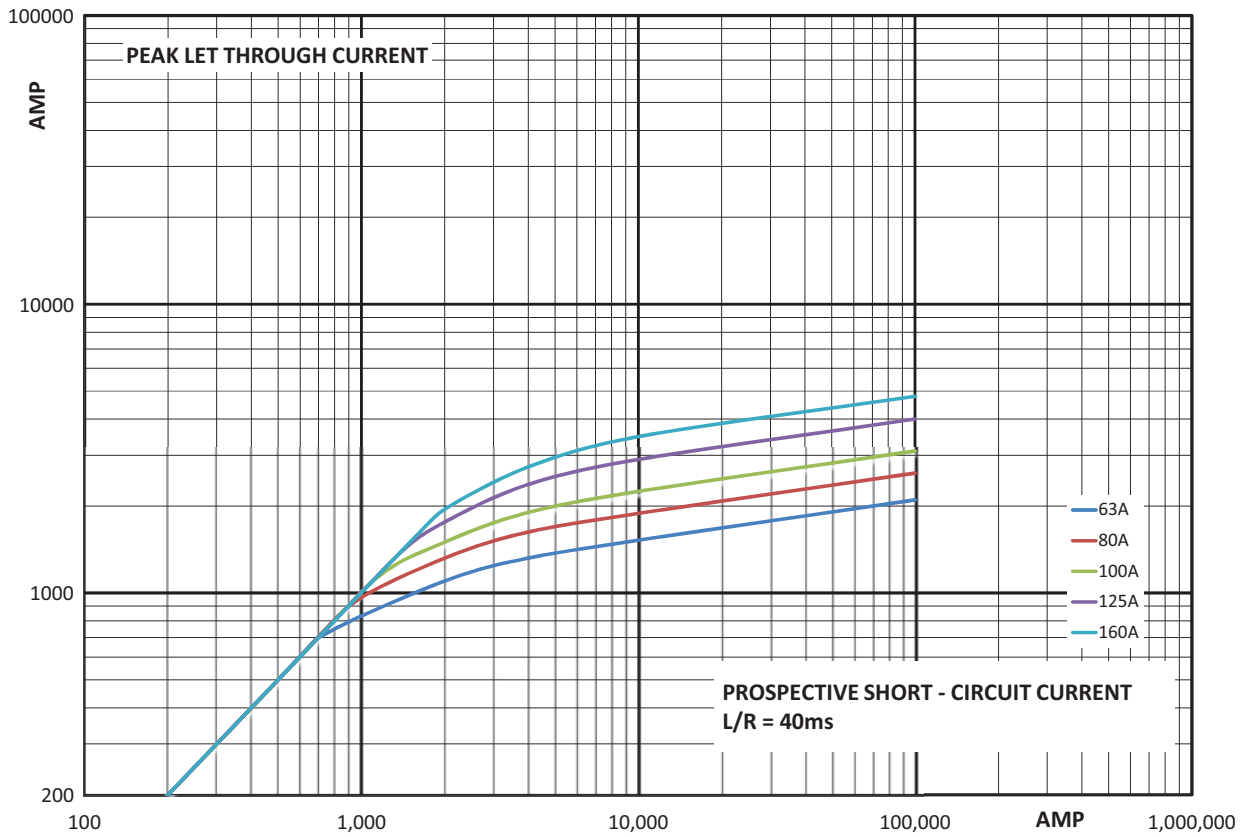

### Arc voltage

This curve gives the peak arc voltage,  $U_L$ , which may appear across the fuse during its operation as a function of the applied working voltage,  $E_g$ , (RMS) at a power factor of 15 percent.

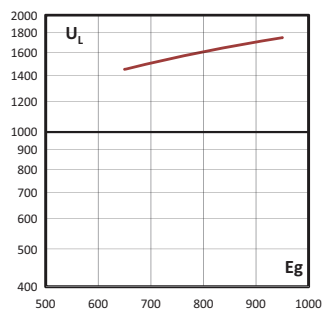

### Watts losses

Watts loss at rated current is given in the electrical characteristics. The curve allows the calculation of the watts losses at load currents lower than the rated current. The correction factor,  $K_p$ , is given as a function of the RMS load current,  $I_b$ , in percent of the rated current.

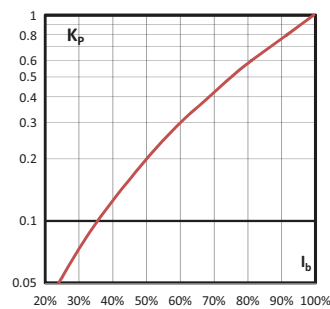

Data sheets: 170K3620 (size 1\*), 170k3622 (size 1), 170K3624 (size 2), 170K3626-A (size 3)

**170E - Sizes 1\*, 1, 2 and 3, Square body fuse links, 750 V d.c. (IEC), 63 A to 500 A**

Time-current curve - Size 1, 200 A and 250 A

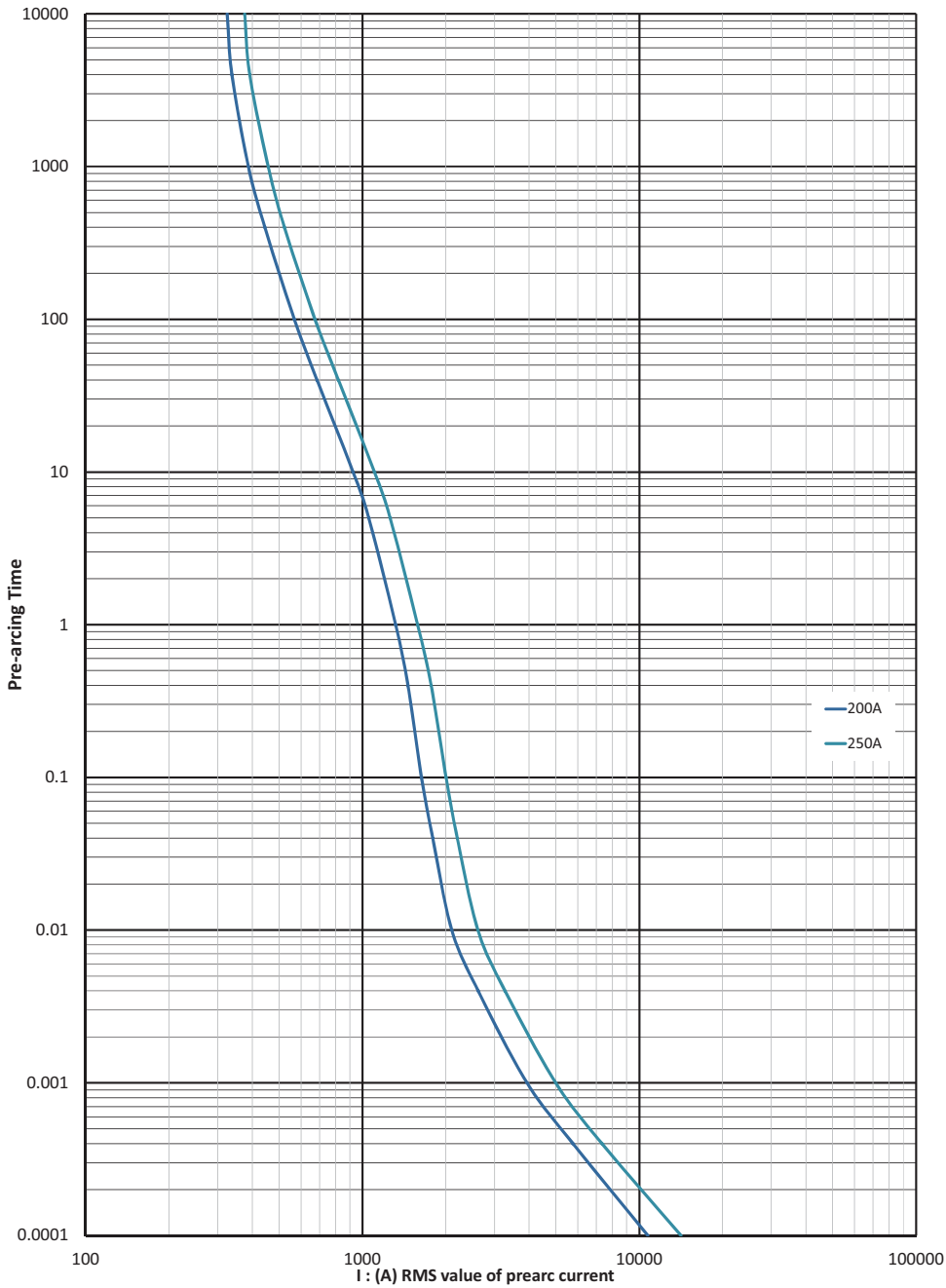

Data sheets: 170K3620 (size 1\*), 170k3622 (size 1), 170K3624 (size 2), 170K3626-A (size 3)

# Traction fuse links

## 170E - Sizes 1\*, 1, 2 and 3, Square body fuse links, 750 V d.c. (IEC), 63 A to 500 A

### Cut-off curve - Size 1, 200 A and 250 A

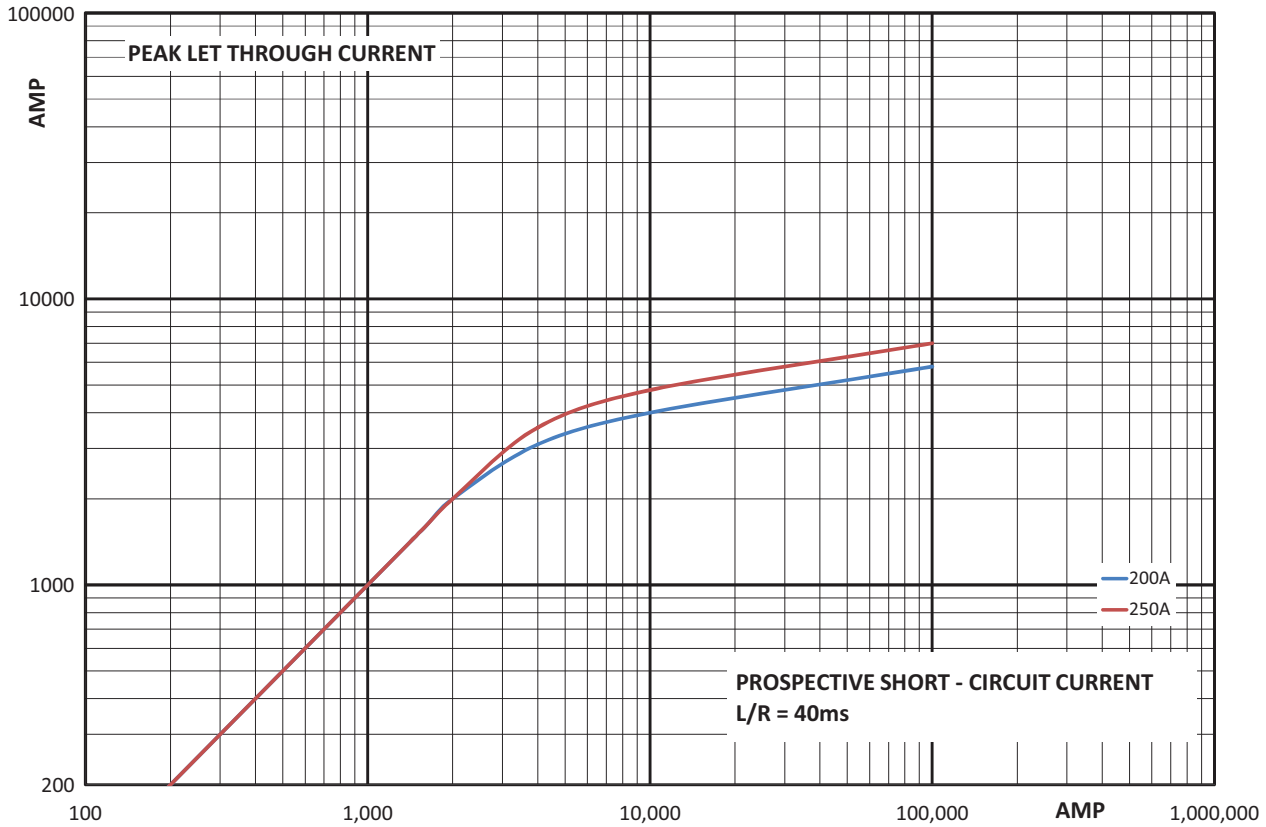

### Arc voltage

This curve gives the peak arc voltage,  $U_L$ , which may appear across the fuse during its operation as a function of the applied working voltage,  $E_g$ , (RMS) at a power factor of 15 percent.

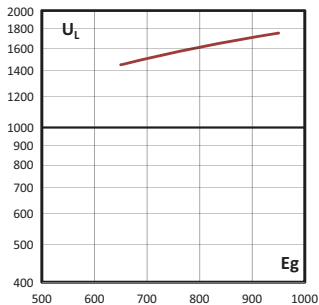

### Watts losses

Watts loss at rated current is given in the electrical characteristics. The curve allows the calculation of the watts losses at load currents lower than the rated current. The correction factor,  $K_p$ , is given as a function of the RMS load current,  $I_b$ , in percent of the rated current.

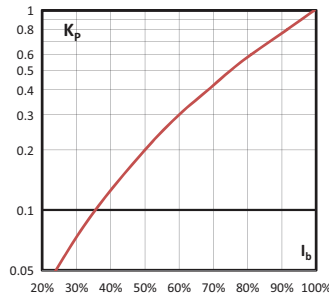

Data sheets: 170K3620 (size 1\*), 170k3622 (size 1), 170K3624 (size 2), 170K3626-A (size 3)



**170E - Sizes 1\*, 1, 2 and 3, Square body fuse links, 750 V d.c. (IEC), 63 A to 500 A**

Time-current curve - Size 2, 250 A to 400 A

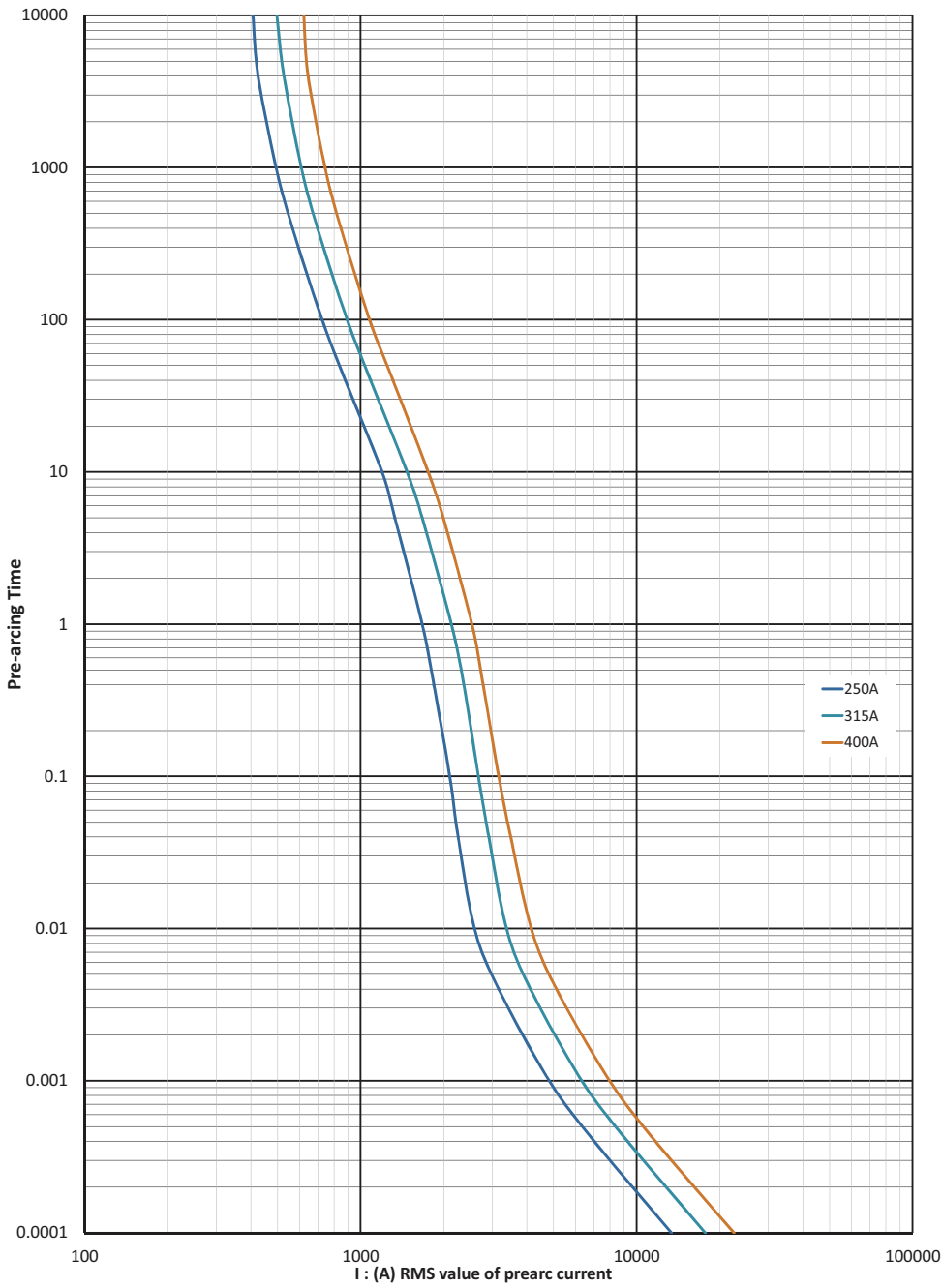

Data sheets: 170K3620 (size 1\*), 170k3622 (size 1), 170K3624 (size 2), 170K3626-A (size 3)

# Traction fuse links

## 170E - Sizes 1\*, 1, 2 and 3, Square body fuse links, 750 V d.c. (IEC), 63 A to 500 A

### Cut-off curve - Size 2, 250 A to 400 A

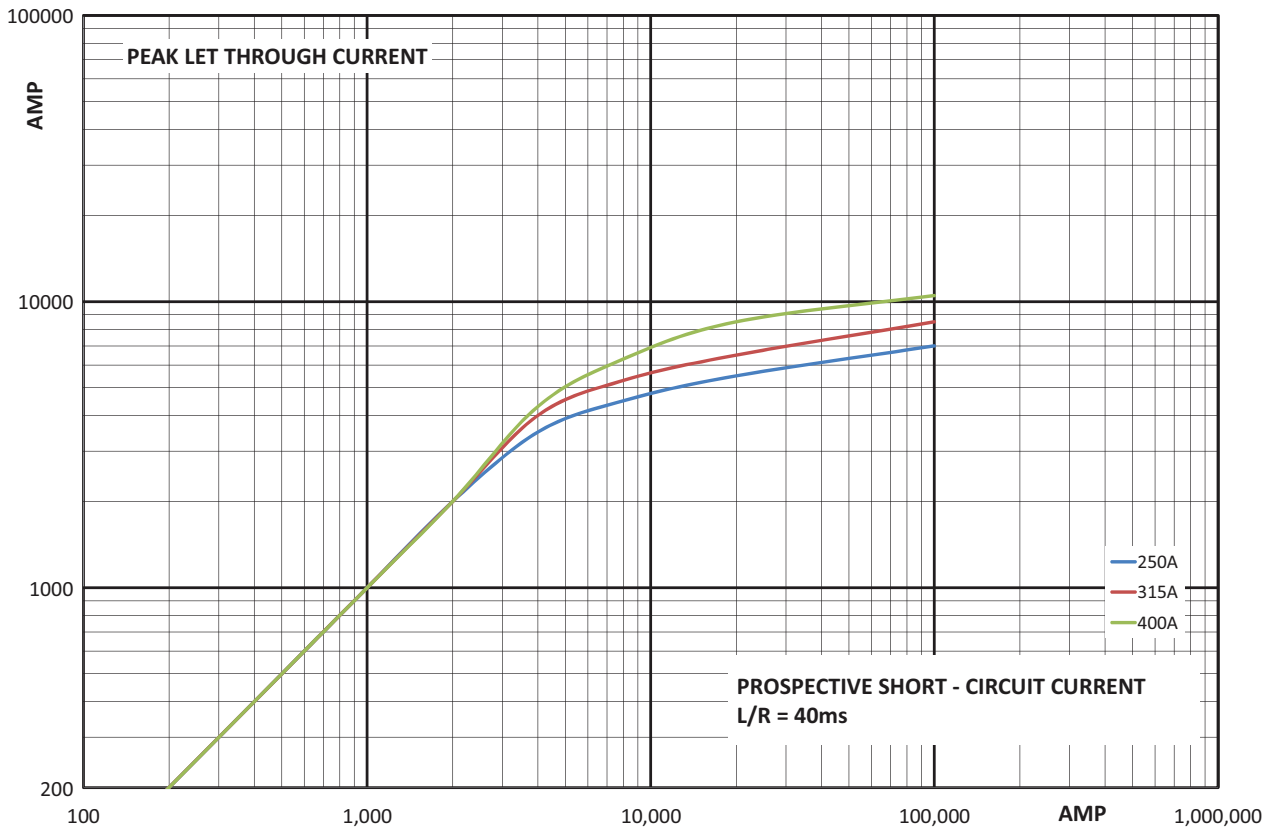

### Arc voltage

This curve gives the peak arc voltage,  $U_L$ , which may appear across the fuse during its operation as a function of the applied working voltage,  $E_g$ , (RMS) at a power factor of 15 percent.

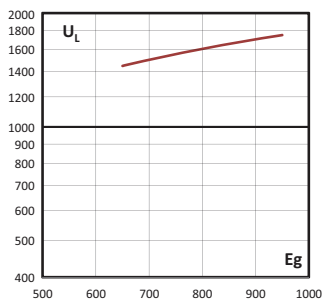

### Watts losses

Watts loss at rated current is given in the electrical characteristics. The curve allows the calculation of the watts losses at load currents lower than the rated current. The correction factor,  $K_p$ , is given as a function of the RMS load current,  $I_b$ , in percent of the rated current.

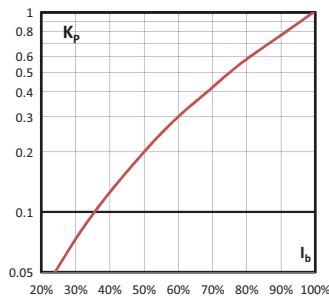

Data sheets: 170K3620 (size 1\*), 170k3622 (size 1), 170K3624 (size 2), 170K3626-A (size 3)

**170E - Sizes 1\*, 1, 2 and 3, Square body fuse links, 750 V d.c. (IEC), 63 A to 500 A**

Time-current curve - Size 3, 500 A

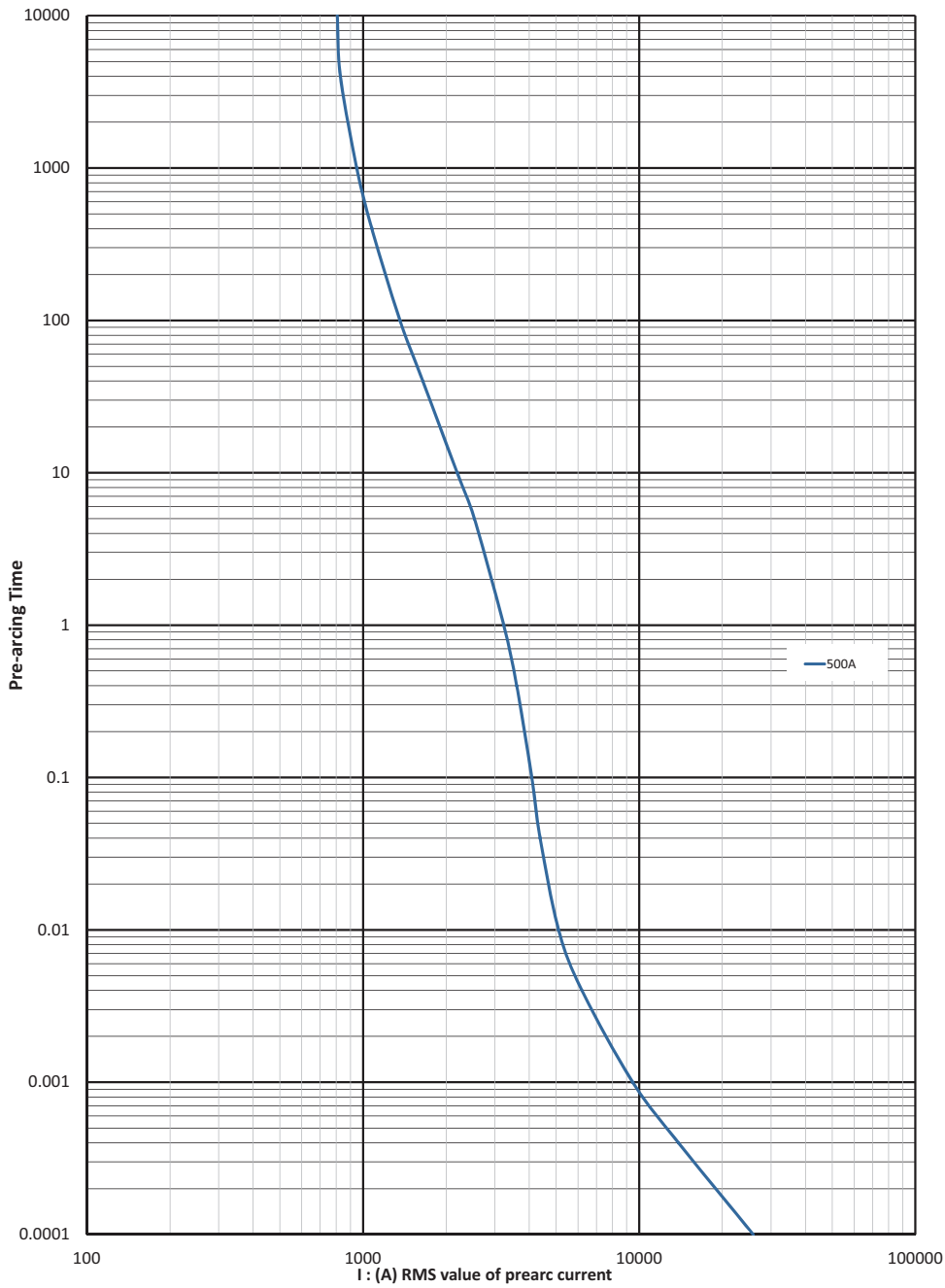

Data sheets: 170K3620 (size 1\*), 170k3622 (size 1), 170K3624 (size 2), 170K3626-A (size 3)

# Traction fuse links

## 170E - Sizes 1\*, 1, 2 and 3, Square body fuse links, 750 V d.c. (IEC), 63 A to 500 A

### Cut-off curve - Size 2, 500 A

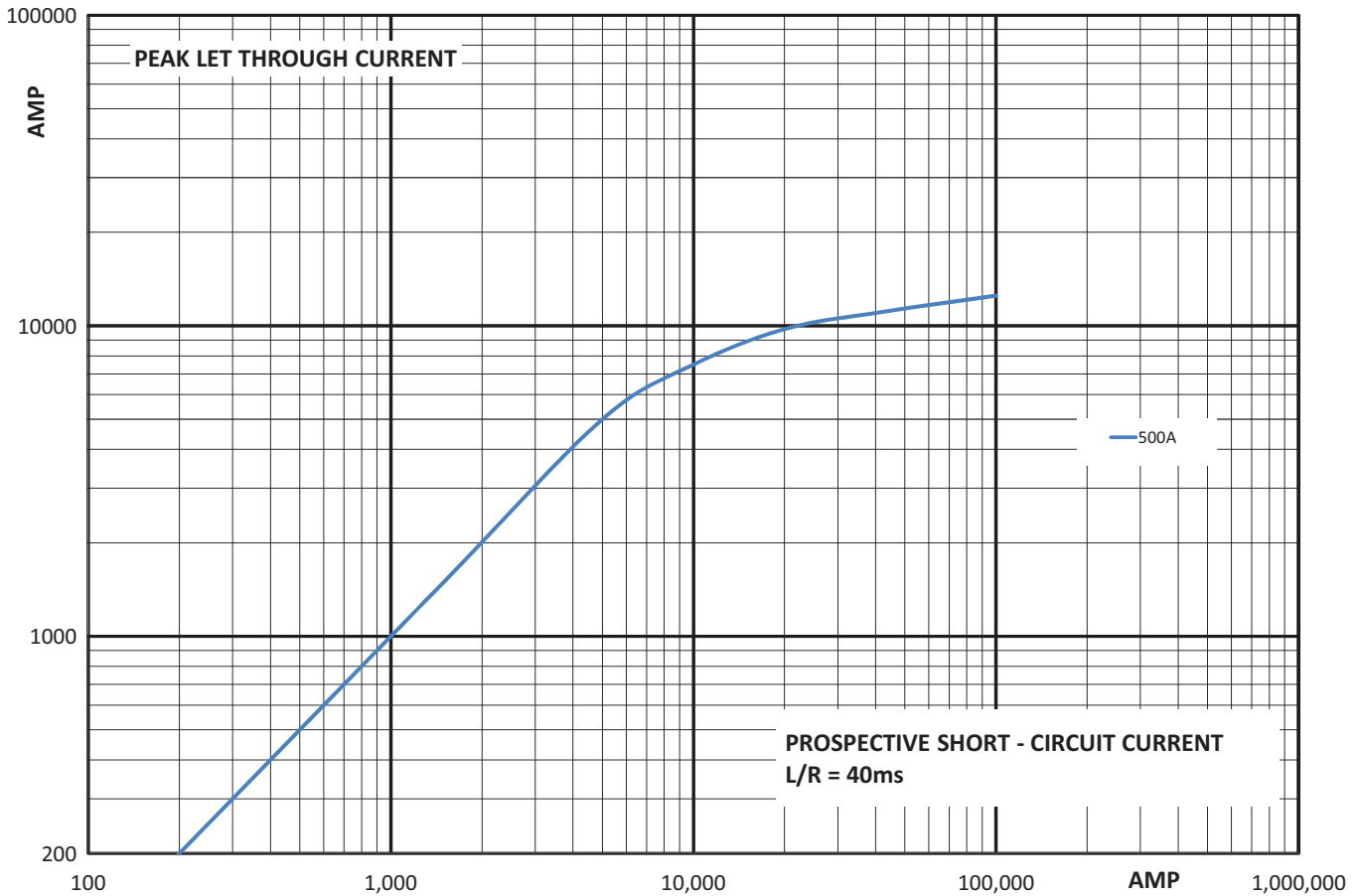

### Arc voltage

This curve gives the peak arc voltage,  $U_L$ , which may appear across the fuse during its operation as a function of the applied working voltage,  $E_g$ , (RMS) at a power factor of 15 percent.

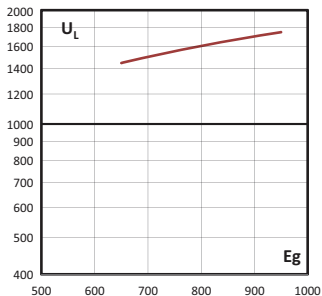

### Watts losses

Watts loss at rated current is given in the electrical characteristics. The curve allows the calculation of the watts losses at load currents lower than the rated current. The correction factor,  $K_p$ , is given as a function of the RMS load current,  $I_b$ , in percent of the rated current.

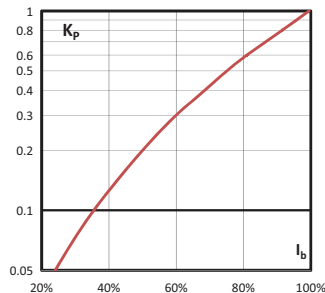

Data sheets: 170K3620 (size 1\*), 170k3622 (size 1), 170K3624 (size 2), 170K3626-A (size 3)

## 170M7217 - Size 4, Square body fuse links, 1250 V a.c. / 850 V d.c. (IEC), 1400 A

### Specifications

#### Description

Traction flush end square body high speed fuse link suitable for use in third rail collector systems to protect high speed DC breakers in low time constant, high fault conditions. Suitable for 1250 V a.c. / 850 V d.c. systems.

#### Technical data

- Rated voltage: 1250 V a.c. / 850 V d.c. (IEC)
- Rated current: 1400 A
- Tested breaking capacity:
  - 100 kA at 1250 V a.c.
  - 80 kA at 850 V d.c., L/R 8ms
- Operating class: aR

#### Standards / Agency information

Consult Eaton [bulehighspeedtechnical@eaton.com](mailto:bulehighspeedtechnical@eaton.com)



#### Catalogue numbers

Fuse link body size	Rated voltage	Rated current (Amps)	I <sup>2</sup> t (A <sup>2</sup> Sec)			Catalogue numbers
			Pre-arcing	Clearing at 1250 V a.c.	Watts loss (W)	
4	850 V d.c./ 1250 V a.c. (IEC)	1400	800,000	5,000,000	195	170M7217
	1000 V d.c. 180 kA IR (UL)					
	1200 V d.c. 85 kA IR (UL)					

#### Dimensions (mm)

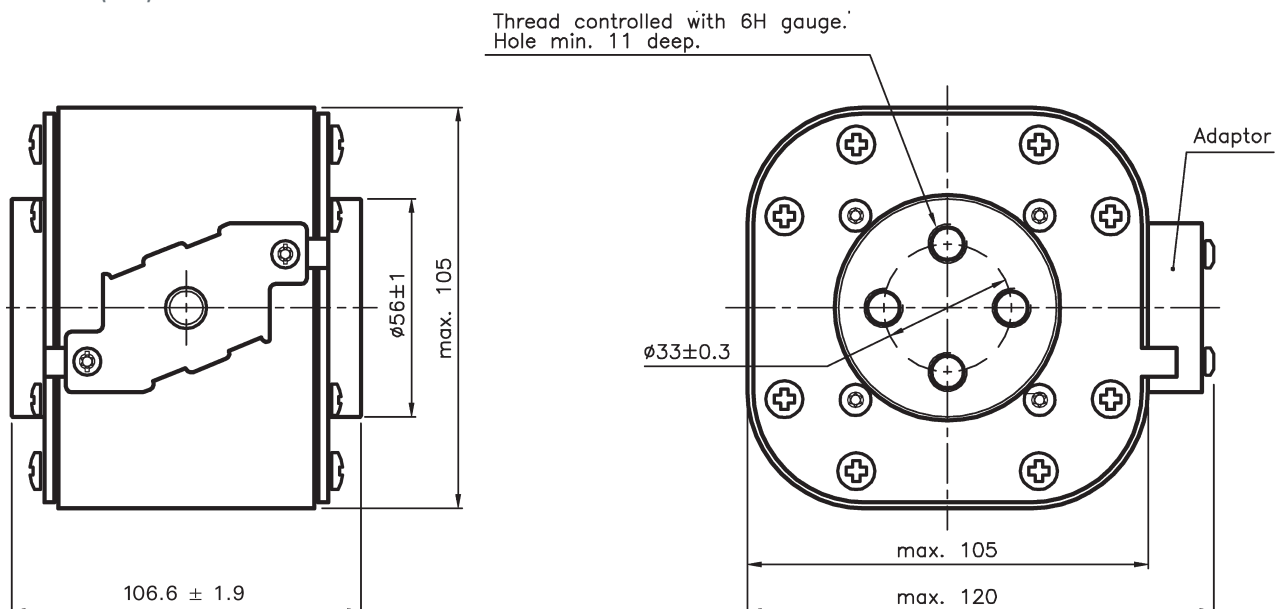

# Traction fuse links

## 170M7217 - Size 4, Square body fuse links, 1250 V a.c. / 850 V d.c. (IEC), 1400 A

### Time-current curve - 1400 A

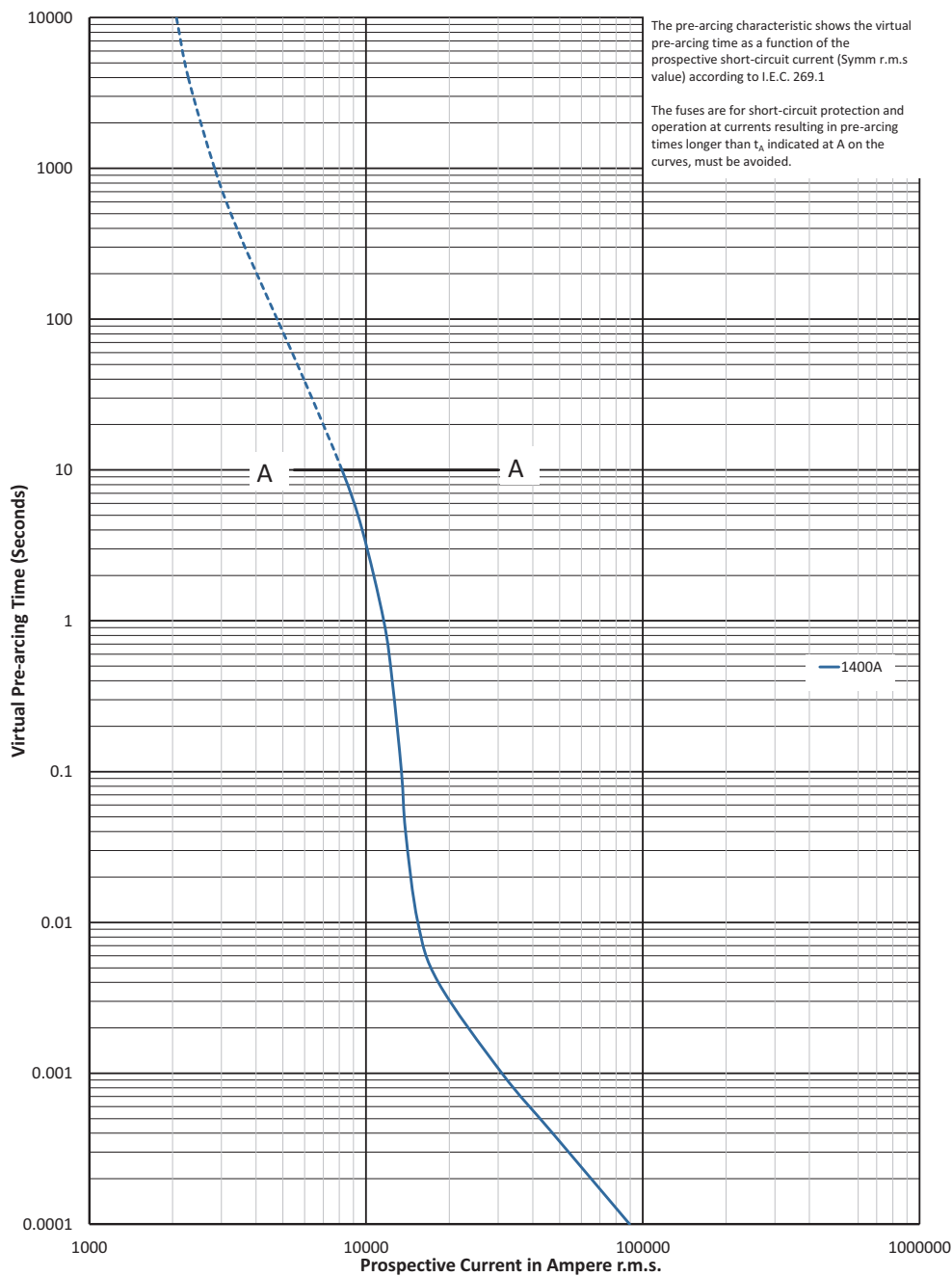

$K_b = 1$   $N = 1.7$

# 170M7217 - Size 4, Square body fuse links, 1250 V a.c. / 850 V d.c. (IEC), 1400 A

## Cut-off curve - 1400 A

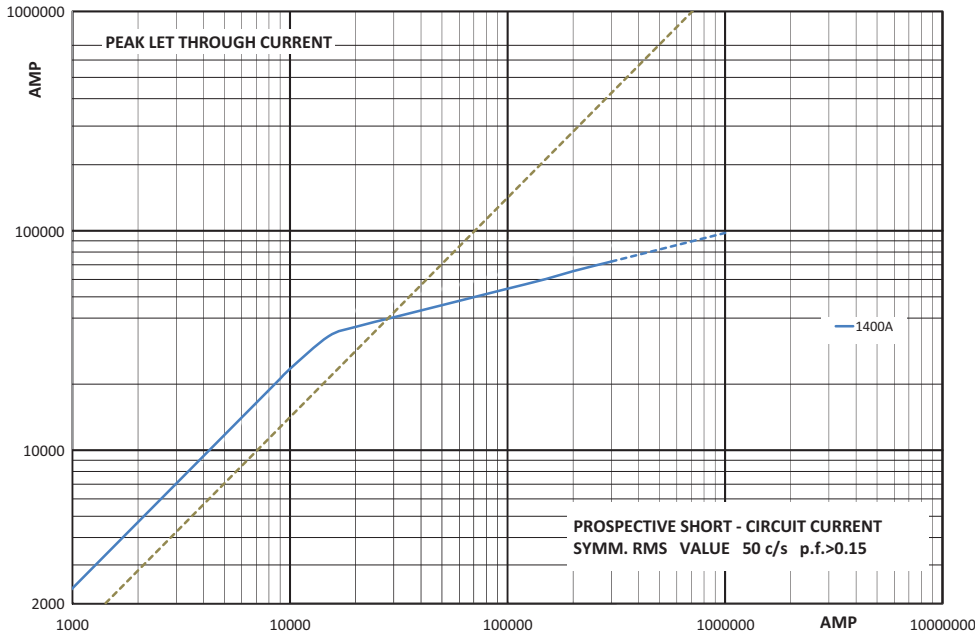

### Total clearing I<sup>2</sup>t

The total clearing I<sup>2</sup>t at rated voltage and at a power factor of 15 percent are given in the electrical characteristics. For other voltages, the clearing I<sup>2</sup>t is found by multiplying by correction factor, K, given as a function of applied working voltage, E<sub>g</sub>, (RMS).

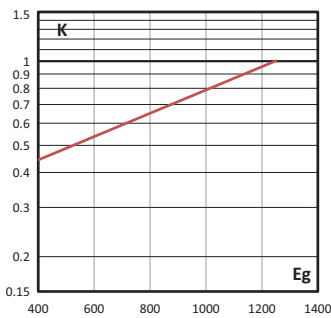

### Arc voltage

This curve gives the peak arc voltage, U<sub>L</sub>, which may appear across the fuse during its operation as a function of the applied working voltage, E<sub>g</sub>, (RMS) at a power factor of 15 percent.

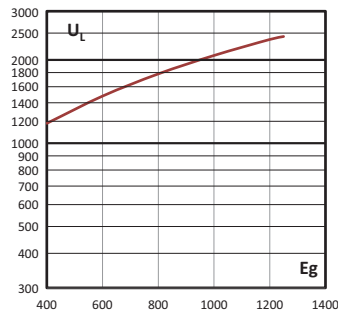

### Watts losses

Watts loss at rated current is given in the electrical characteristics. The curve allows the calculation of the watts losses at load currents lower than the rated current. The correction factor, K<sub>p</sub>, is given as a function of the RMS load current, I<sub>b</sub>, in percent of the rated current.

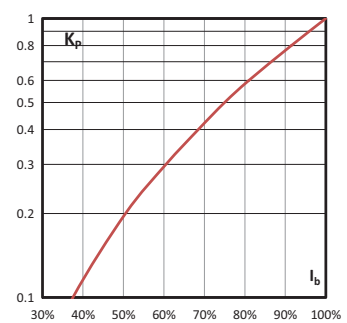

# Traction fuse links

## 170M - Size 1\*, Square body fuse links, 1200 V d.c. (IEC), 20 A to 215A

### Specifications

#### Description

Traction bolted tags square body high speed fuse links for superior protection of DC third rail applications up to 1200 V d.c.

#### Technical data

- Rated voltage: 1200 V d.c. (IEC)
- Rated current: 20 A to 215 A
- Tested breaking capacity: 100 kA at 1200 V d.c., L/R 15ms
- Operating class: aR

#### Standards / Agency information

IEC 60269

#### Catalogue numbers



Fuse link type	Fuse link body size	Rated voltage	Rated current (Amps)	I <sup>t</sup> (A <sup>2</sup> Sec)		Watts loss (W)		Catalogue numbers
				Pre-arcing	Clearing at 1200 V d.c.	0.8 I <sub>n</sub>	I <sub>n</sub>	
Single slot tag	1*	1200 V d.c. (IEC)	20	82	249	1	2	170M2100
			25	173	526	4	8	170M2101
			32	327	994	5	9	170M2102
			40	550	1675	1	9	170M2103
			50	950	2890	7	13	170M2104
			63	1310	3990	5	9	170M2105
			80	1970	6000	13	23	170M2106
			100	3800	11,600	14	26	170M2107
			125	8550	26,025	13	24	170M2108
			160	8770	26,700	24	44	170M2109
			200	15,200	46,300	29	52	170M2110
			215	16,430	50,000	32	58	170M2111

#### Dimensions (mm)

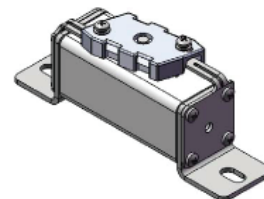
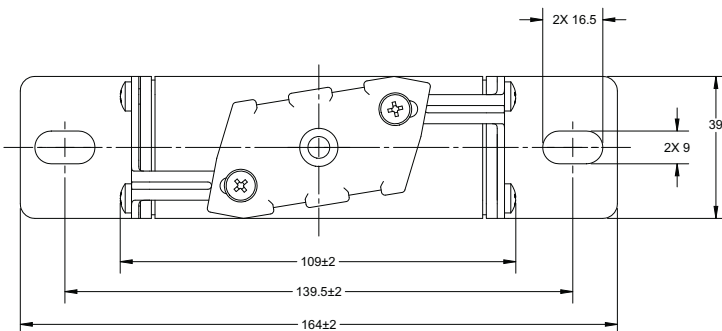
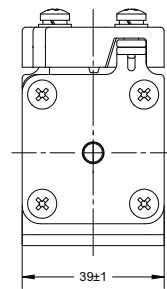
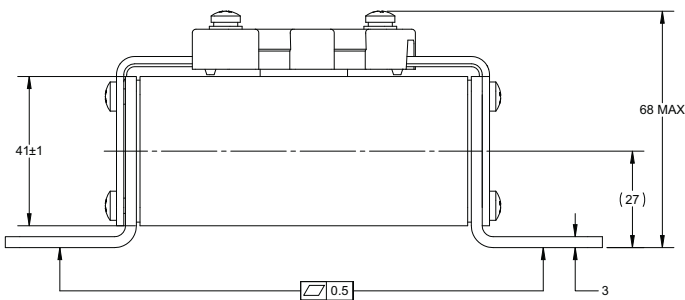

Data sheet: 5785523



**170M - Size 1\*, Square body fuse links, 1200 V d.c. (IEC), 20 A to 215A**

Time-current curve - 20 A to 215 A

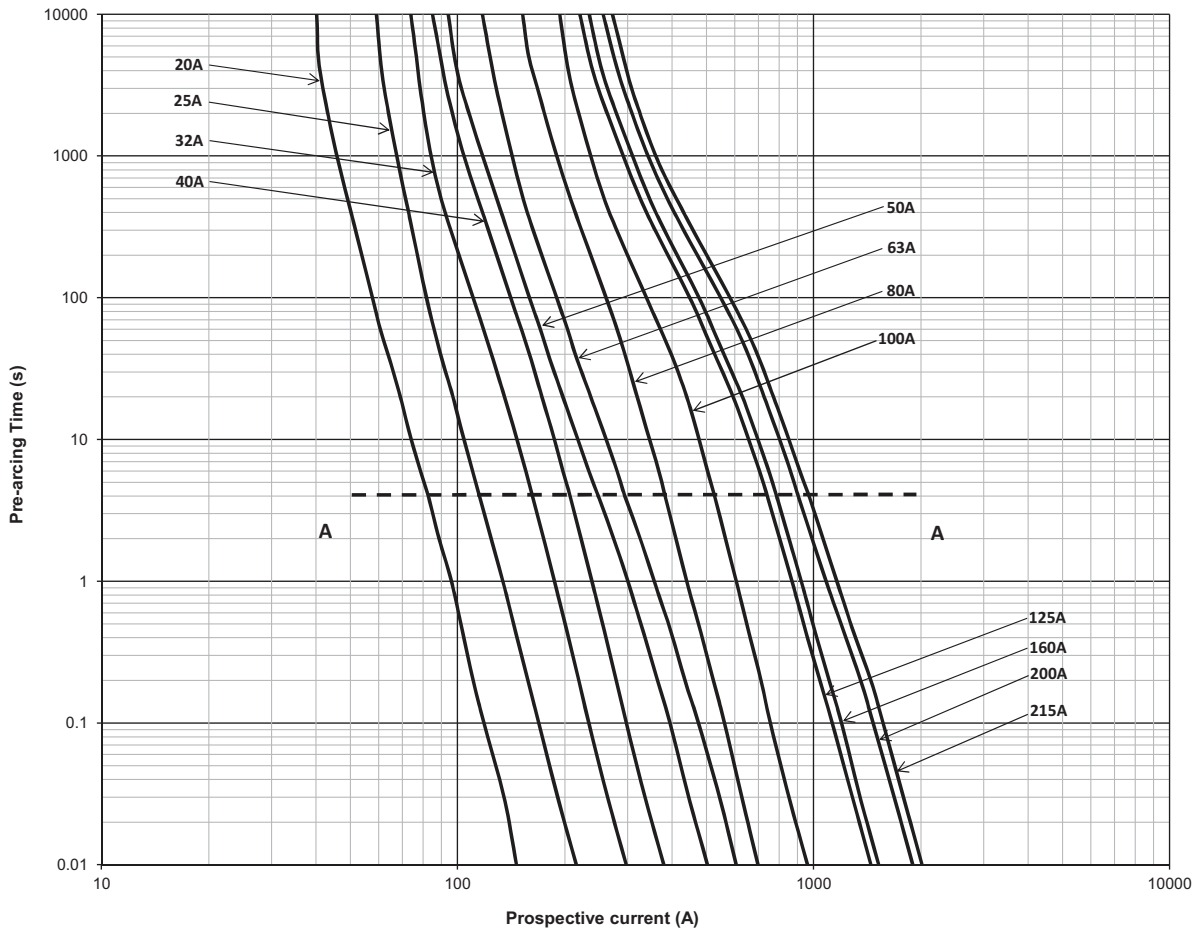

# Traction fuse links

## 170F - Size 2, Square body fuse links, 1200 V d.c. (IEC), 160 A to 420 A

### Specifications

#### Description

Traction bolted tags square body high speed fuse link for superior protection in DC traction applications up to 1200 V d.c.

#### Technical data

- Rated voltage:
  - 1200 V d.c. (IEC)
  - 1050 V d.c. (UL)
- Rated current: 160 A to 420 A
- Breaking capacity:
  - 100 kA at 1000 V d.c., L/R = 45ms
  - 100 kA at 1200 V d.c., L/R = 15ms
- Operating class: aR

#### Standards / Agency information

Contact Eaton [bulehighspeedtechnical@eaton.com](mailto:bulehighspeedtechnical@eaton.com)



#### Catalogue numbers

Fuse link type	Fuse link body size	Rated voltage	Rated current (Amps)	I <sub>t</sub> (A <sup>2</sup> Sec)		Watts loss (W)	Catalogue numbers
				1000 V d.c. L/R 15ms	1000 V d.c. L/R 45ms		
Double slotted tag	2	1200 V d.c. (IEC)	160	12,000	20,000	75	170F8230
			200	20,000	35,000	85	170F8231
			250	43,000	75,000	94	170F8232
		1050 V d.c. (UL)	315	87,000	150,000	104	170F8233
			400	180,000	310,000	120	170F8234
			420	215,000	375,000	122	170F8235

#### Dimensions (mm)

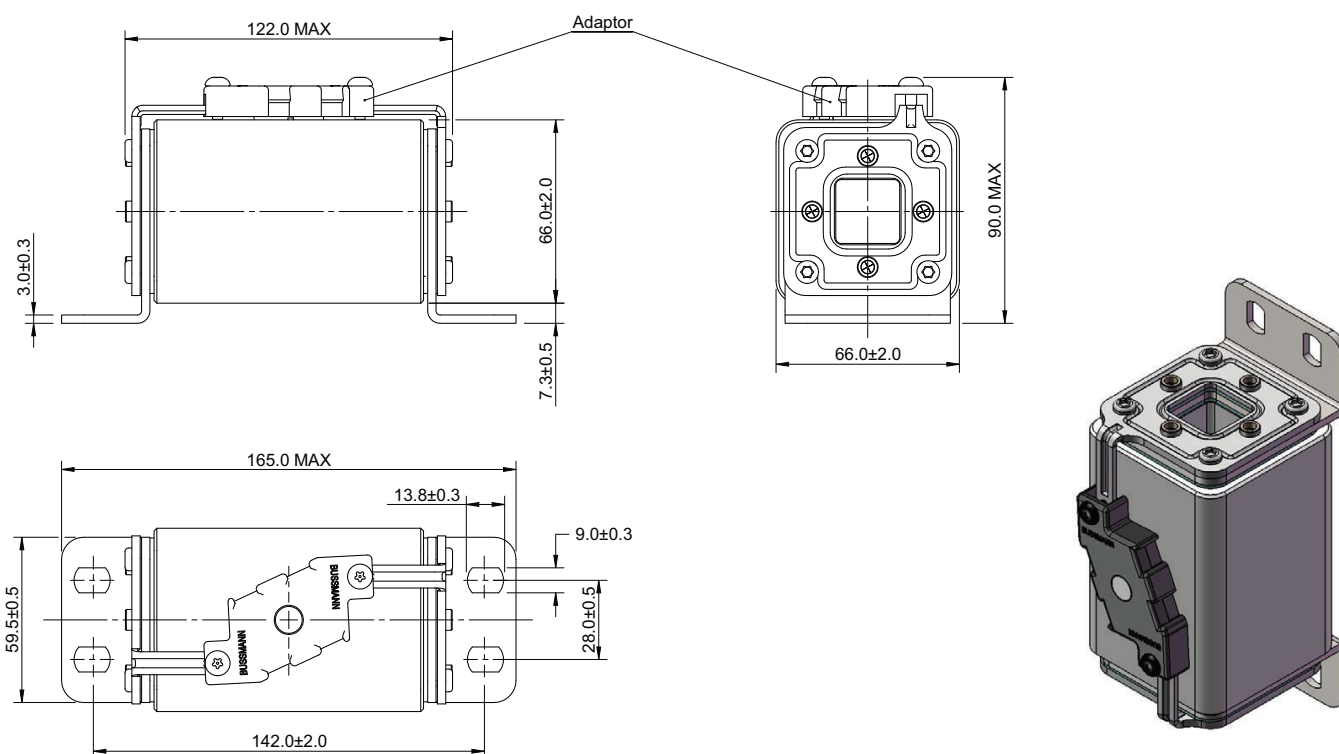

Data sheet: 170K5520

# 170F - Size 2, Square body fuse links, 1200 V d.c. (IEC), 160 A to 420 A

## Time-current curve - 160 A to 420 A

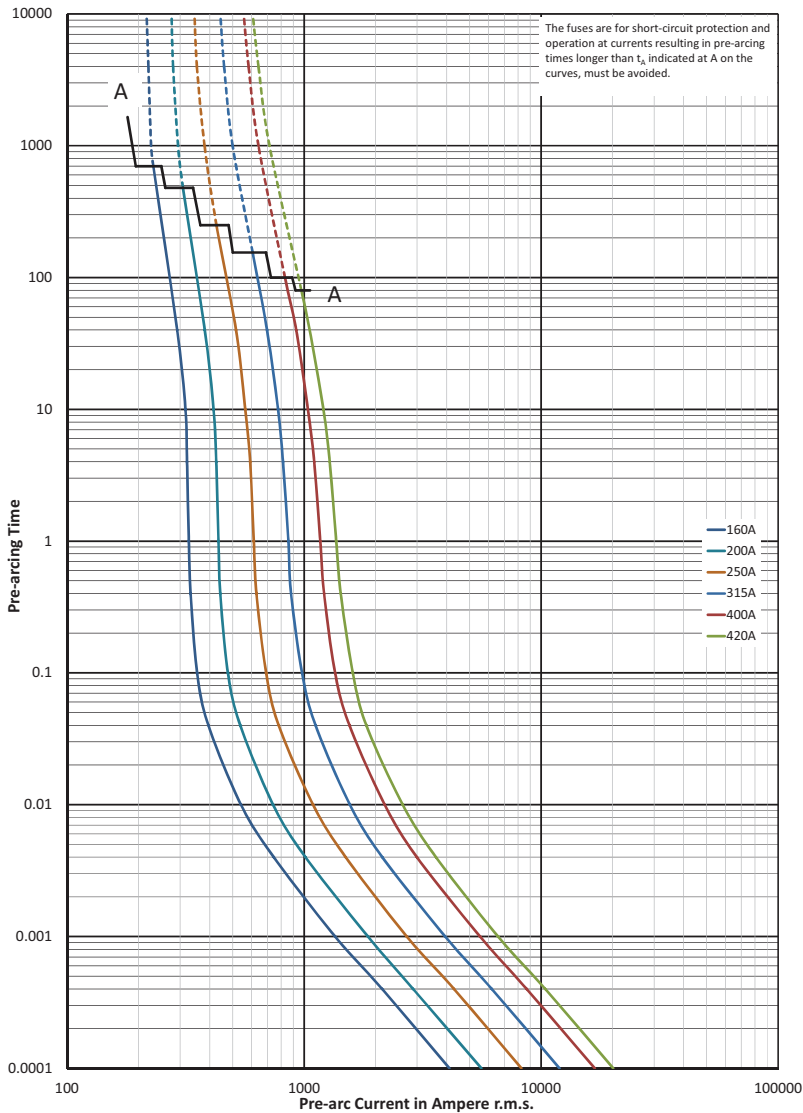

### Total clearing $I^2t$

The total clearing  $I^2t$  at rated voltage and at a power factor of 15 percent are given in the electrical characteristics. For other voltages, the clearing  $I^2t$  is found by multiplying by correction factor,  $K$ , given as a function of applied working voltage,  $E_g$ , (RMS).

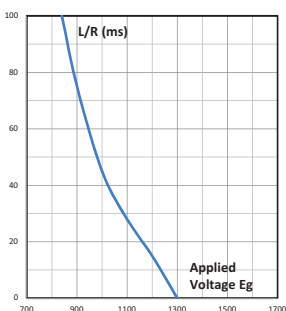

### Arc voltage

This curve gives the peak arc voltage,  $U_L$ , which may appear across the fuse during its operation as a function of the applied working voltage,  $E_g$ , (RMS) at a power factor of 15 percent.

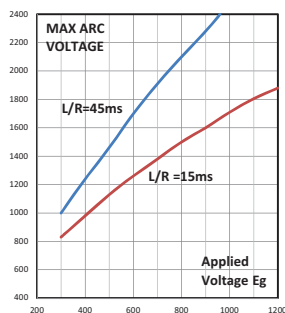

### Watts losses

Watts loss at rated current is given in the electrical characteristics. The curve allows the calculation of the watts losses at load currents lower than the rated current. The correction factor,  $K_p$ , is given as a function of the RMS load current,  $I_b$ , in percent of the rated current.

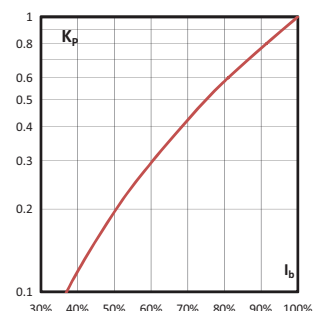

# Traction fuse links

## 170E - Size 1\*, Square body fuse links, 2000 V d.c. (IEC), 10 A to 80 A

### Specifications

#### Description

Traction bolted tags square body high speed fuse link which provides superior protection in DC traction applications up to 2000 V d.c.

#### Technical data

- Rated voltage: 2000 V d.c. (IEC)
- Rated current: 10 A to 80 A
- Tested breaking capacity: 40 kA at 2000 V d.c., L/R 30ms
- Operating class: gR

#### Standards / Agency information

Contact Eaton [bulehighspeedtechnical@eaton.com](mailto:bulehighspeedtechnical@eaton.com)



#### Catalogue numbers

Fuse link type	Fuse link body size	Rated voltage	Rated current (Amps)	Watts loss (W)	Catalogue numbers
Knife blade style 1*		2000 V d.c.(IEC)	10	7	170E3977
			12	8	170E3982
			16	11	170E3971
			20	13	170E3906
			25	17	170E3907
			32	22	170E3908
			40	27	170E3909
			50	34	170E3910
			63	43	170E3911
			80	50	170E3912

#### Dimensions (mm)

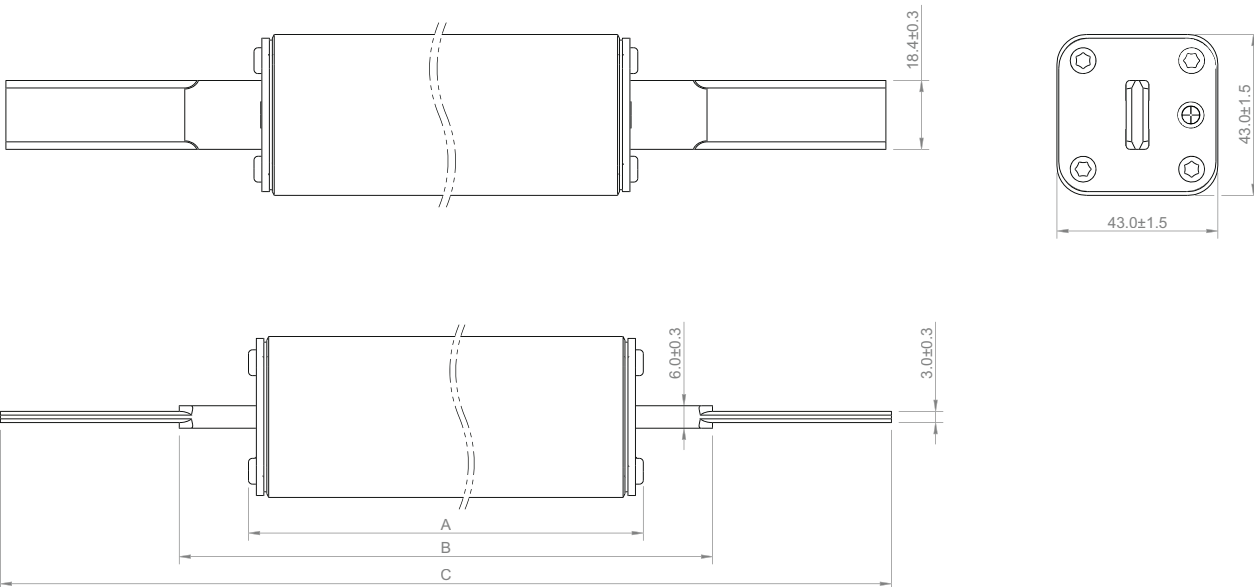

A	B	C
215 ± 2.5	250.5 ± 3.2	245.5 ± 3.5

Data sheet: 170K4538

**170E - Size 1\*, Square body fuse links, 2000 V d.c. (IEC), 10 A to 80 A**

Time-current curve - 10 A to 80 A

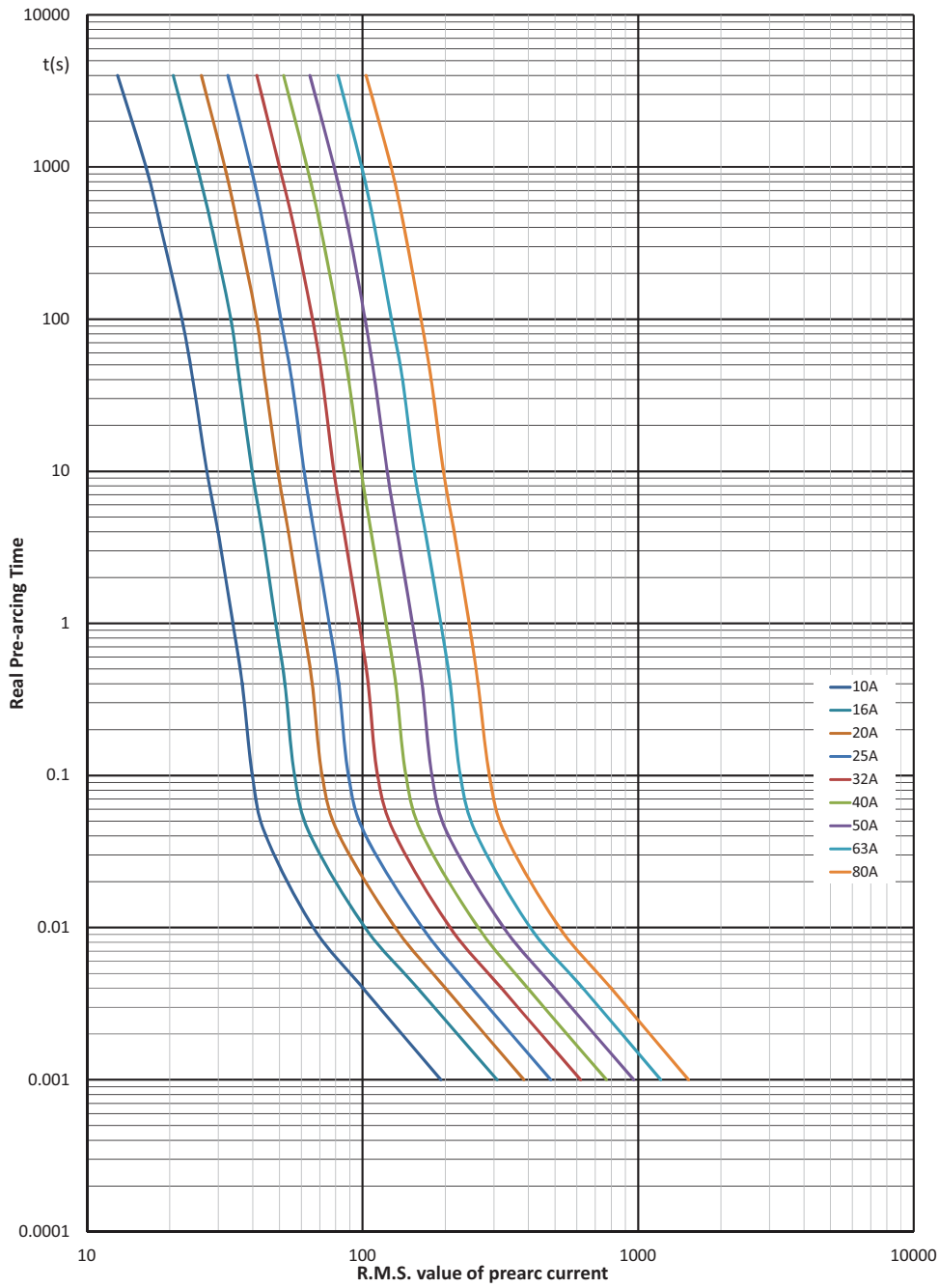

# Traction fuse links

## 170E - Size 1\*, Square body fuse links, 2000 V d.c. (IEC), 10 A to 80 A

### Cut-off curve - 10 A to 80 A

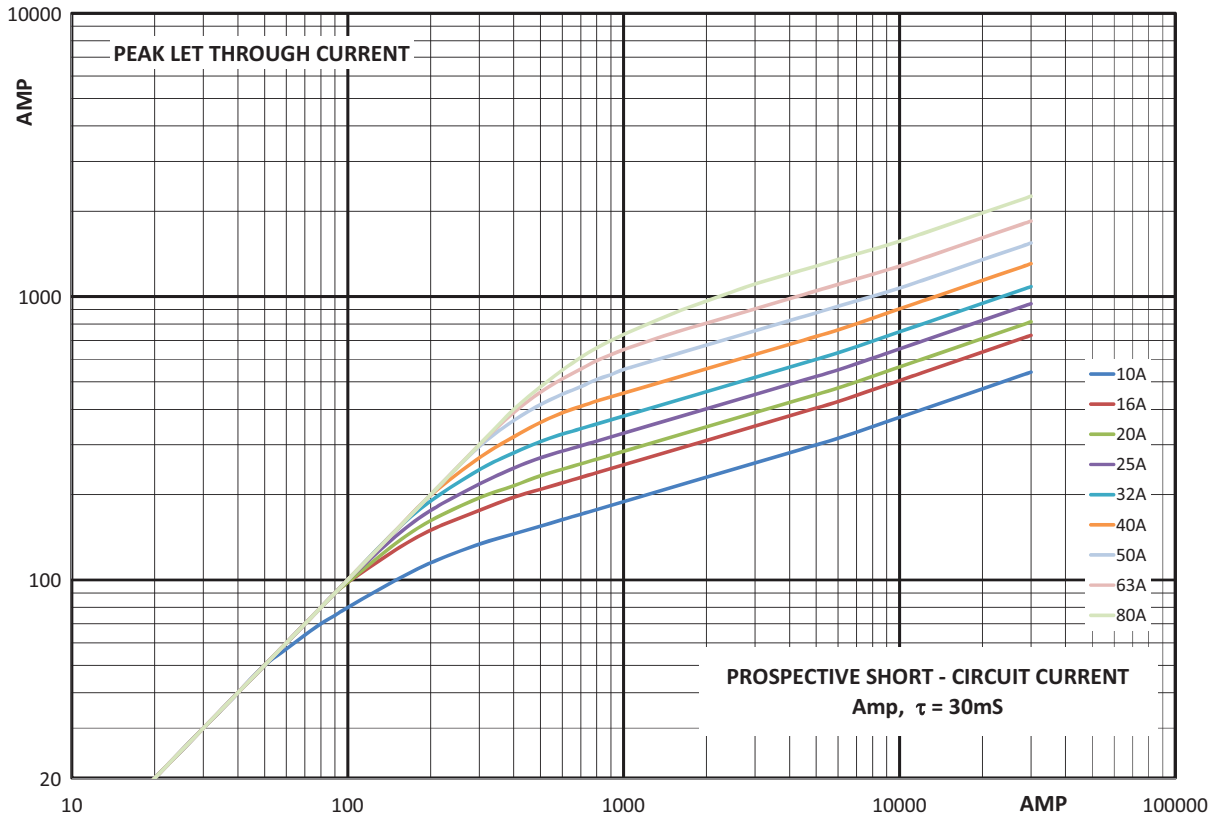

### Total clearing $I^2t$

The total clearing  $I^2t$  at rated voltage and at a power factor of 15 percent are given in the electrical characteristics. For other voltages, the clearing  $I^2t$  is found by multiplying by correction factor, K, given as a function of applied working voltage,  $E_g$ , (RMS).

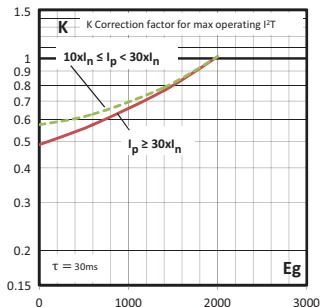

### Arc voltage

This curve gives the peak arc voltage,  $U_L$ , which may appear across the fuse during its operation as a function of the applied working voltage,  $E_g$ , (RMS) at a power factor of 15 percent.

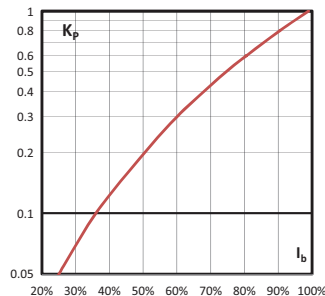

### Watts losses

Watts loss at rated current is given in the electrical characteristics. The curve allows the calculation of the watts losses at load currents lower than the rated current. The correction factor,  $K_b$ , is given as a function of the RMS load current,  $I_b$ , in percent of the rated current.

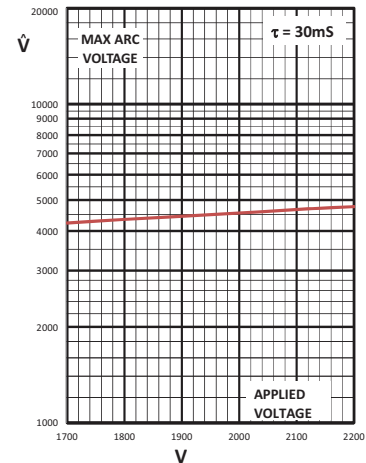

## 170E - Size 1\*, Square body fuse links, 2000 V d.c. (IEC), 10 A to 125 A

### Specifications

#### Description

Traction bolted tags square body high speed fuse link which provides superior protection in DC traction applications up to 2000 V d.c..

#### Technical data

- Rated voltage: 2000 V d.c. (IEC)
- Rated current: 10 A to 125 A
- Tested breaking capacity: 40 kA at 2000 V d.c., L/R 20ms
- Operating class: aR

#### Standards / Agency information

Contact Eaton [bulehighspeedtechnical@eaton.com](mailto:bulehighspeedtechnical@eaton.com)

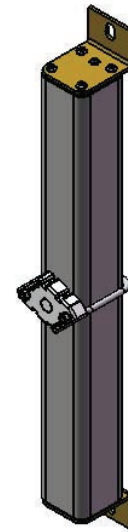

#### Catalogue numbers

Fuse link type	Fuse link body size	Rated voltage	Rated current (Amps)	Watts loss (W)	Catalogue numbers
Bolted blade Style	1*	2000 V d.c. (IEC)	20	13	170E3937
			25	16	170E3938
			32	20	170E3939
			40	25	170E3940
			50	32	170E3941
			63	40	170E3942
			80	51	170E3943
			100	64	170E3944
			125	80	170E3945
			10	7	170E3976
			16	11	170E3970
			20	13	170E3950
			25	17	170E3951
			32	22	170E3952
			40	27	170E3953
			50	34	170E3954
			63	43	170E3955
			80	50	170E3956

#### Dimensions (mm)

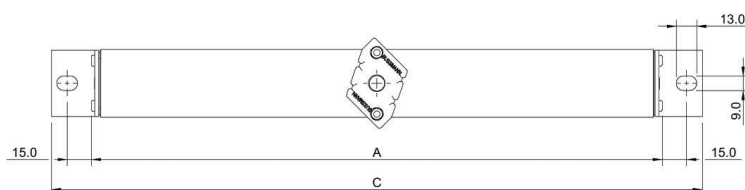
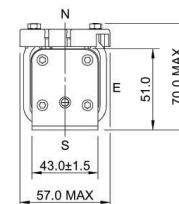
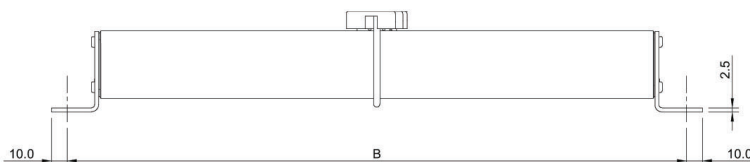

A	B	C
217	246	266

Data sheets: 170K4538 (10 A to 80 A), 170K4900 (20 A to 125 A)

# Traction fuse links

## 170E - Size 1\*, Square body fuse links, 2000 V d.c. (IEC), 10 A to 125 A

Time-current curve - 10 A to 80 A

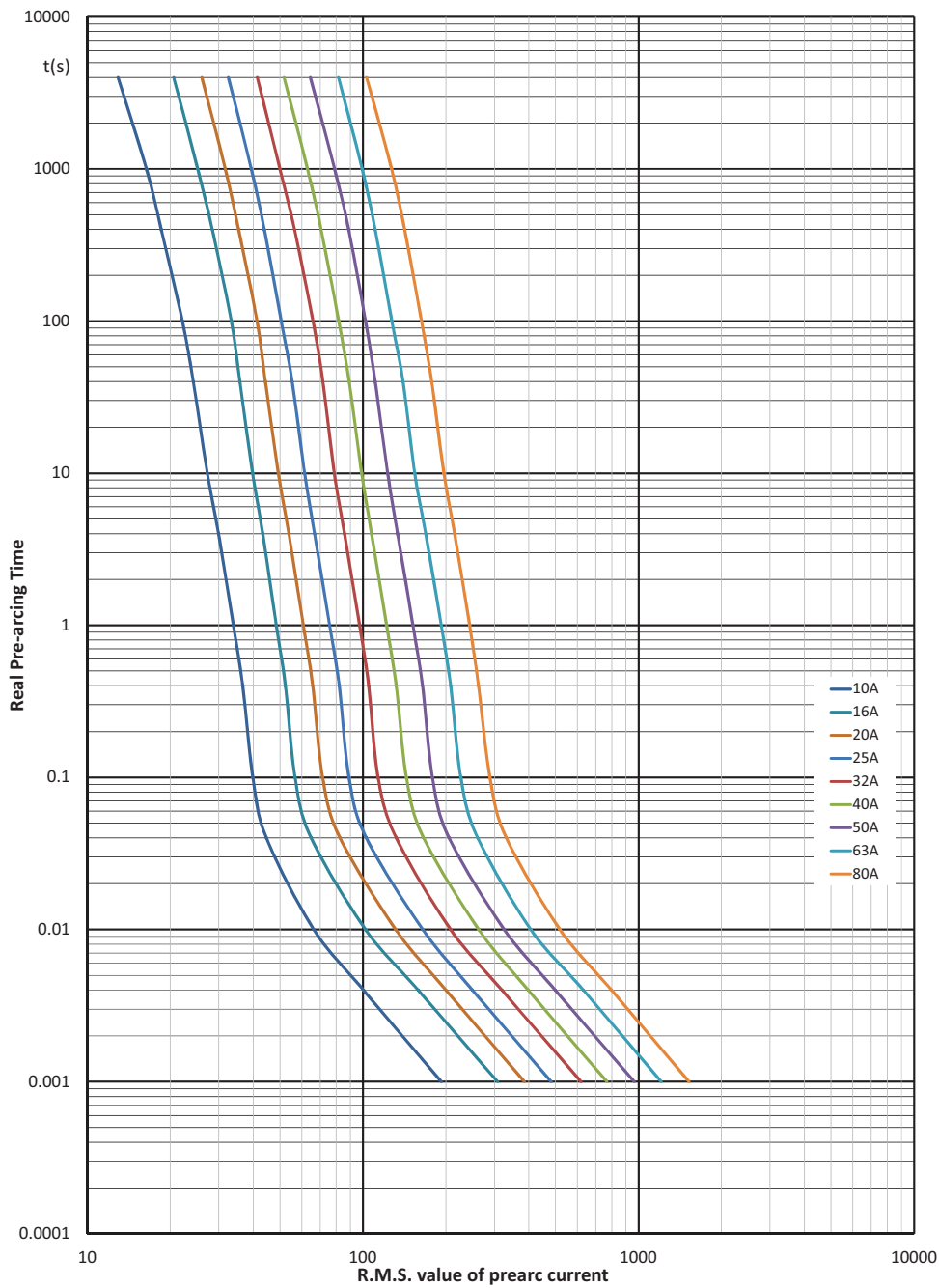

Data sheets: 170K4538 (10 A to 80 A), 170K4900 (20 A to 125 A)



# 170E - Size 1\*, Square body fuse links, 2000 V d.c. (IEC), 10 A to 125 A

## Cut-off curve - 10 A to 80 A

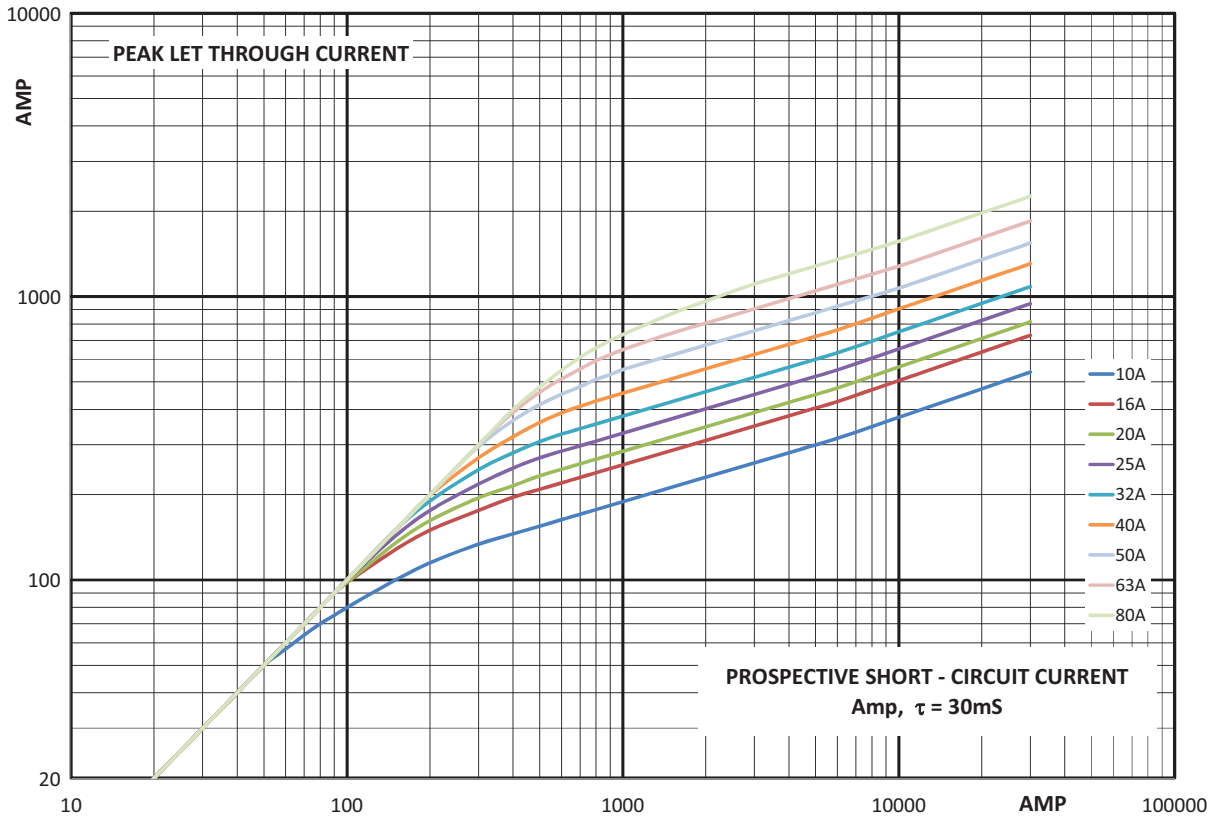

### Total clearing $I^2t$

The total clearing  $I^2t$  at rated voltage and at a power factor of 15 percent are given in the electrical characteristics. For other voltages, the clearing  $I^2t$  is found by multiplying by correction factor,  $K$ , given as a function of applied working voltage,  $E_g$ , (RMS).

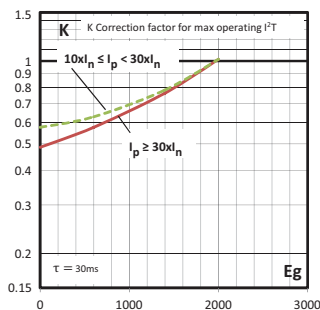

### Arc voltage

This curve gives the peak arc voltage,  $U_L$ , which may appear across the fuse during its operation as a function of the applied working voltage,  $E_g$ , (RMS) at a power factor of 15 percent.

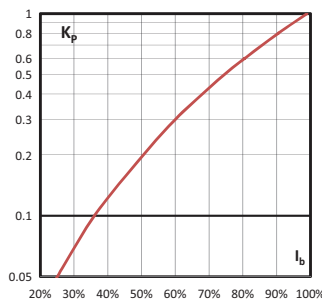

### Watts losses

Watts loss at rated current is given in the electrical characteristics. The curve allows the calculation of the watts losses at load currents lower than the rated current. The correction factor,  $K_p$ , is given as a function of the RMS load current,  $I_b$ , in percent of the rated current.

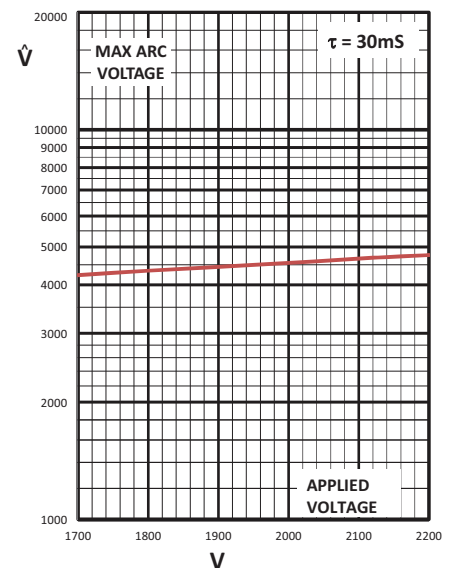

Data sheets: 170K4538 (10 A to 80 A), 170K4900 (20 A to 125 A)

# Traction fuse links

## 170E - Size 1\*, Square body fuse links, 2000 V d.c. (IEC), 10 A to 125 A

### Time-current curve - 20 A to 125 A

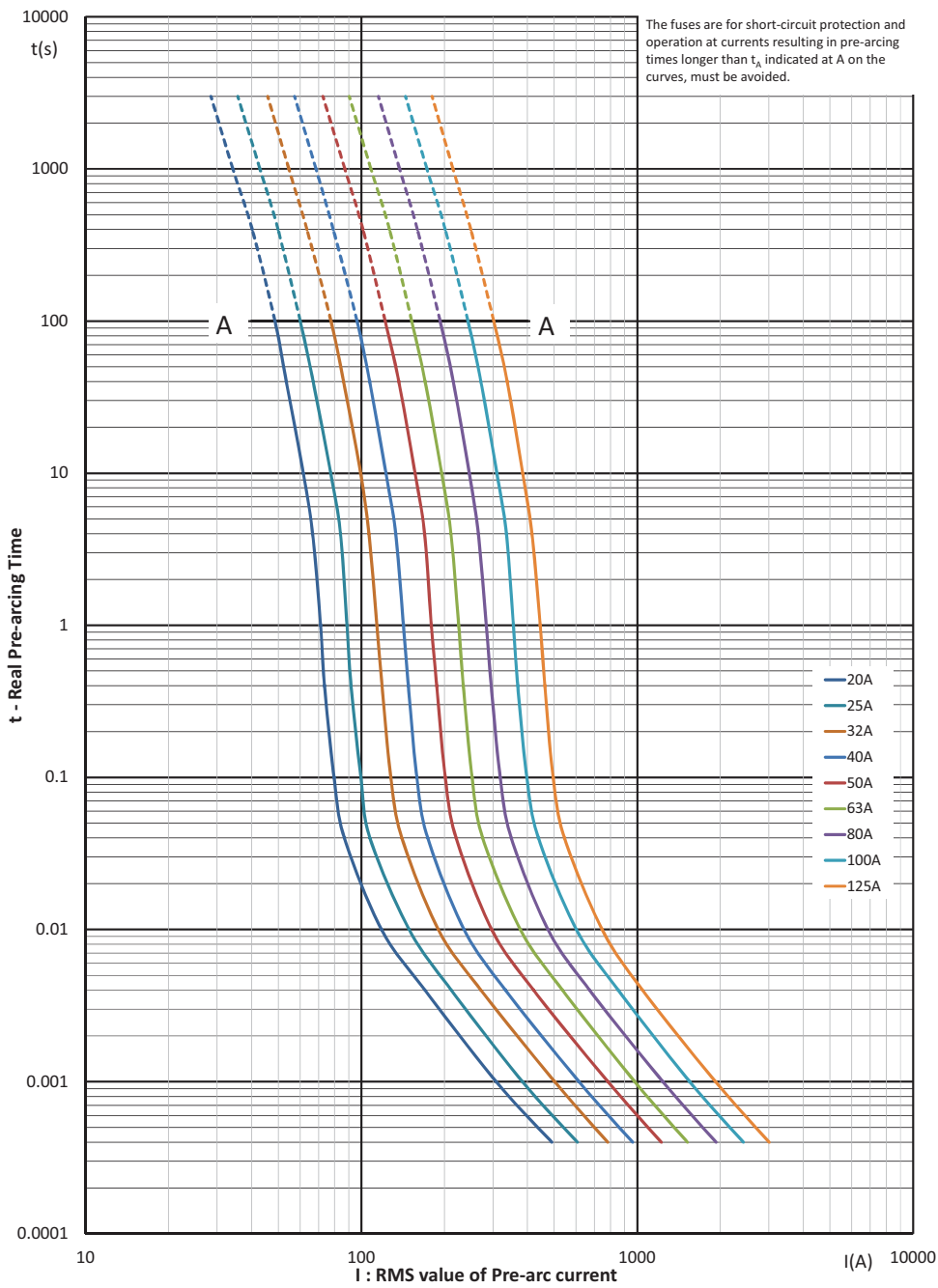

Data sheets: 170K4538 (10 A to 80 A), 170K4900 (20 A to 125 A)

## 170E - Size 1\*, Square body fuse links, 2000 V d.c. (IEC), 10 A to 125 A

### Cut-off curve - 20 A to 125 A

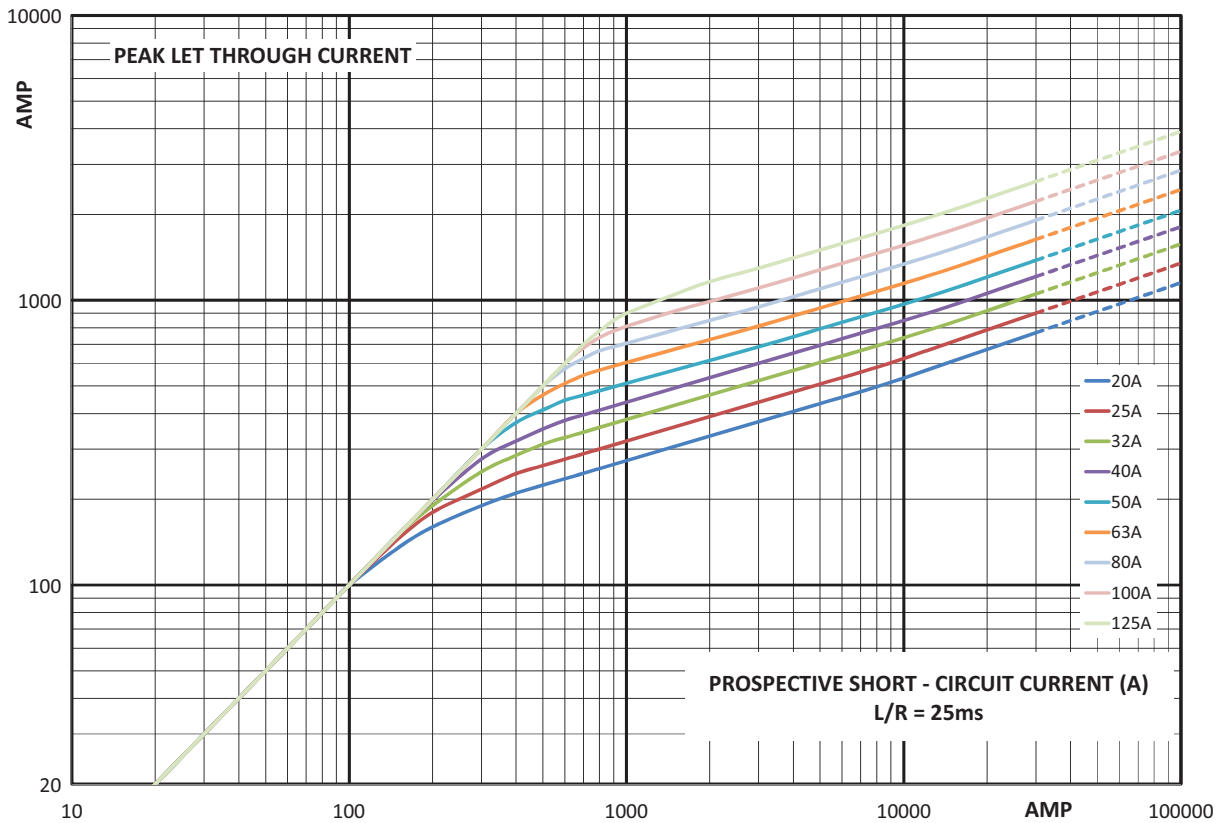

### Total clearing $I^2t$

The total clearing  $I^2t$  at rated voltage and at a power factor of 15 percent are given in the electrical characteristics. For other voltages, the clearing  $I^2t$  is found by multiplying by correction factor,  $K$ , given as a function of applied working voltage,  $E_g$ , (RMS).

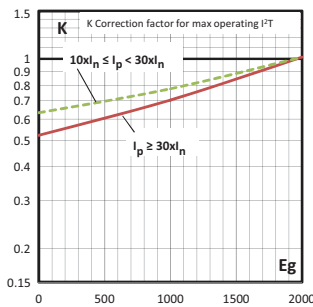

### Arc voltage

This curve gives the peak arc voltage,  $U_l$ , which may appear across the fuse during its operation as a function of the applied working voltage,  $E_g$ , (RMS) at a power factor of 15 percent.

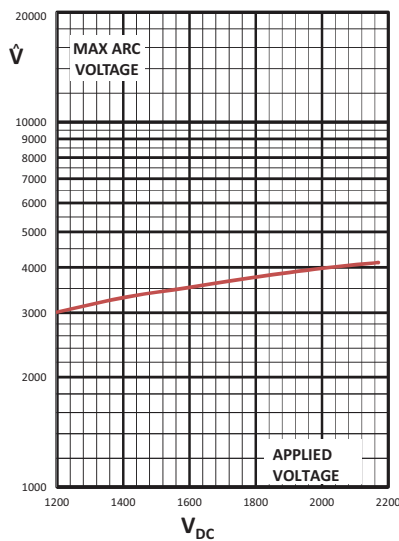

### Watts losses

Watts loss at rated current is given in the electrical characteristics. The curve allows the calculation of the watts losses at load currents lower than the rated current. The correction factor,  $K_p$ , is given as a function of the RMS load current,  $I_b$ , in percent of the rated current.

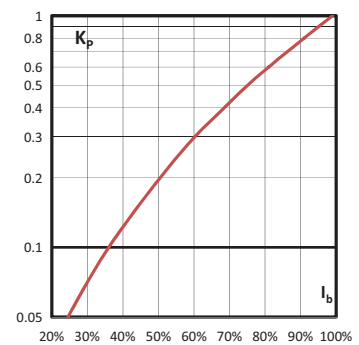

# Traction fuse links

## 170M - Square body fuse links, 2000 V d.c. (IEC), 20 A to 600 A

### Specifications

#### Description

Traction bolted tags square body high speed fuse links which provides superior protection for DC traction third rail applications up to 2000 V d.c.

#### Technical data

- Rated voltage: 2000 V d.c. (IEC)
- Rated current:
  - 20 A to 215 A Single slot tag
  - 160 A to 400 A Double slot tag
  - 500 A to 600 A Parallel double slot tag
- Breaking capacity:
  - 100 kA at 2000 V d.c., L/R <15ms
  - 100 kA at 1500 V d.c., L/R <45ms
- Operating class: aR

#### Standards / Agency information

Tested in line with IEC 60269



#### Catalogue numbers

Fuse link type	Rated voltage	Rated current (Amps)	I <sup>2</sup> t (A <sup>2</sup> Sec)		Watts loss (W)		Catalogue numbers
			Pre-arcing	Total at 2000 V d.c.	0.8 I <sub>n</sub>	I <sub>n</sub>	
Single slot tag	2000 V d.c. (IEC)	20	85	240	9	12	170M2046
		25	130	390	9	16	170M2047
		32	220	645	11	18	170M2048
		40	390	1140	12	20	170M2049
		50	610	1780	17	33	170M2050
		63	1030	3000	20	39	170M2051
	1500 V d.c. (UL)	80	1555	4550	28	53	170M2052
		100	2680	7840	33	63	170M2053
		125	4110	12,020	42	79	170M2054
		160	6620	19,360	45	87	170M2055
		200	10,720	31,360	50	95	170M2056
		215	21,870	64,000	51	97	170M2057
Double slot tag	2000 V d.c. (IEC)	160	7900	42,000	68	91	170M2039
		200	12,300	66,000	85	113	170M2040
		250	21,900	120,000	100	133	170M2041
		315	38,900	210,000	119	158	170M2042
		400	65,700	350,000	148	176	170M2043
Parallel double slot tag	2000 V d.c. (IEC)	500	105,851	163,010	109	230	170M2044
		600	188,179	289,796	153	305	170M2045

Data sheets: 720142, 5785522 (Single slot, 5785519 Double slot tag, 5785526 Parallel double slot tag)

**170M - Square body fuse links, 2000 V d.c. (IEC), 20 A to 600 A**

Dimensions (mm) - 170M2046 to 170M2057, Single slot tag

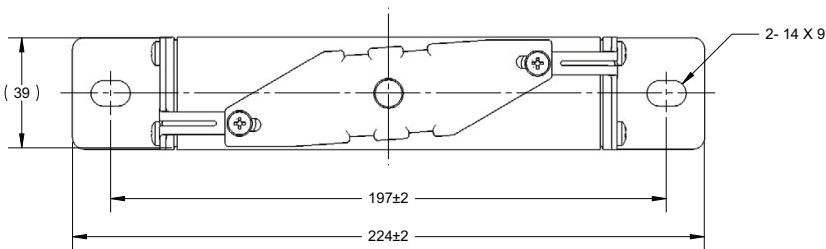
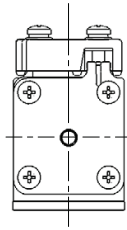
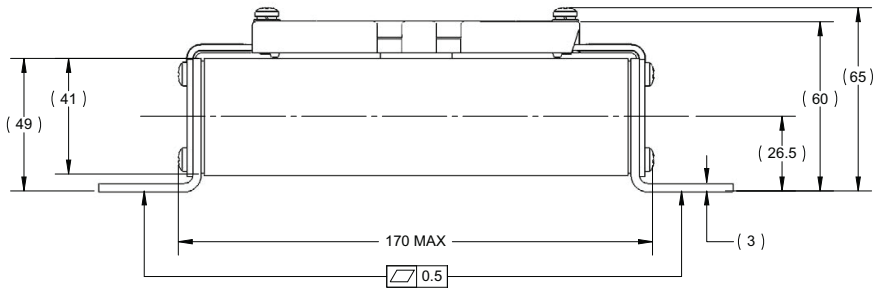

Dimensions (mm) - 170M2039 to 170M2043, Double slot tag

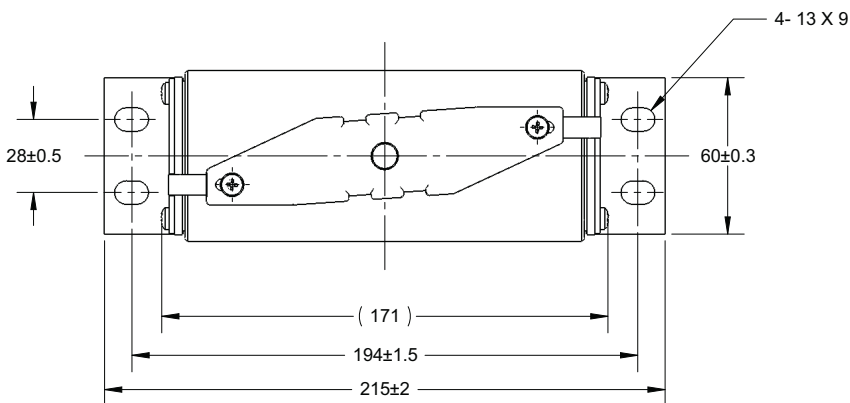
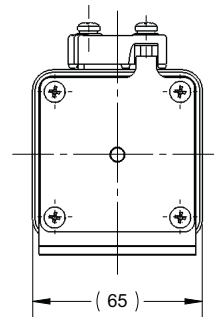
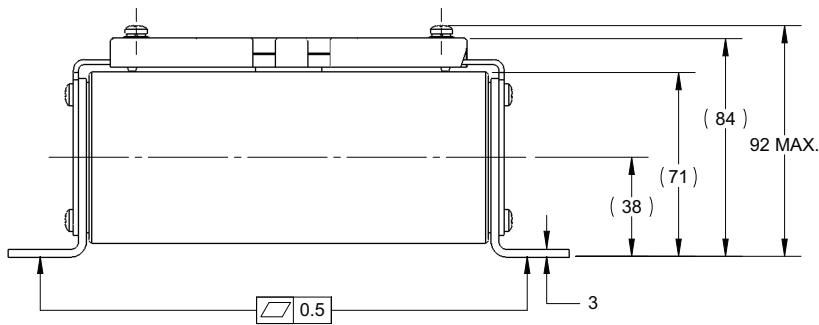

Data sheets: 720142, 5785522 (Single slot, 5785519 Double slot tag, 5785526 Parallel double slot tag)

# Traction fuse links

## 170M - Square body fuse links, 2000 V d.c. (IEC), 20 A to 600 A

Dimensions (mm) - 170M2044 and 170M2045, Parallel, double slot tag

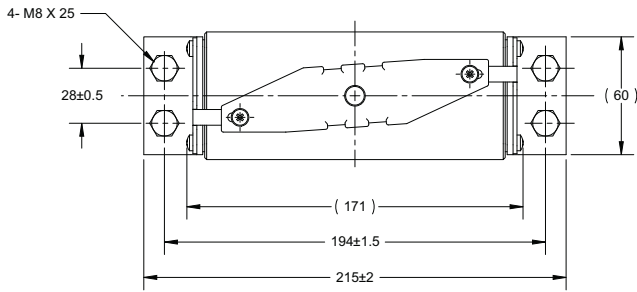
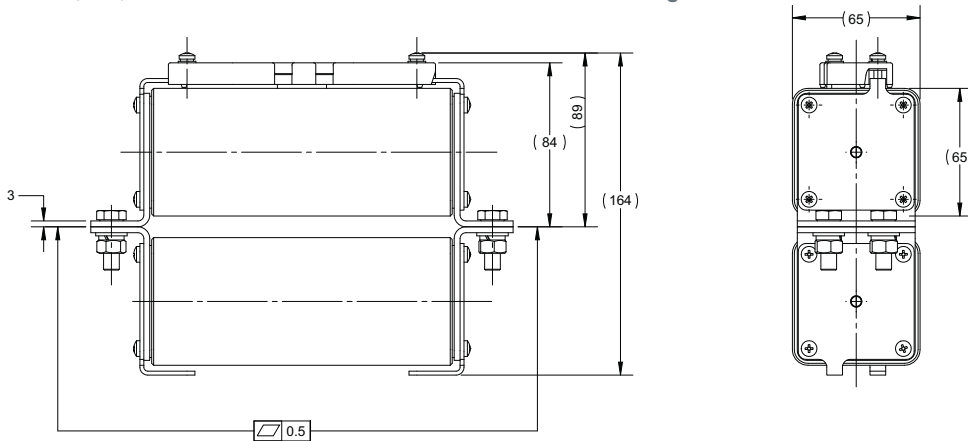

Time-current curve - 170M2046 to 170M2056, 20 A to 215 A

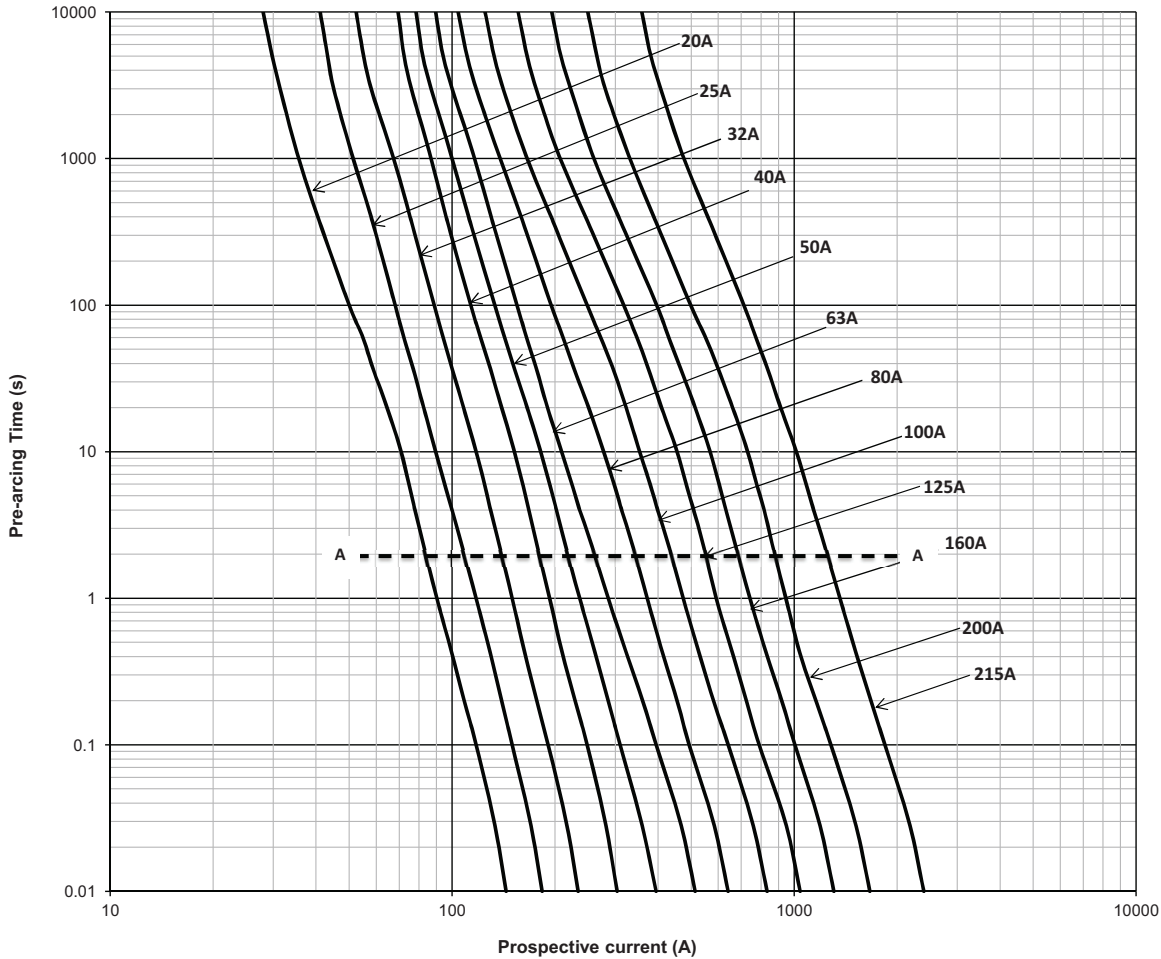

Data sheets: 720142, 5785522 (Single slot, 5785519 Double slot tag, 5785526 Parallel double slot tag)

## 170M - Square body fuse links, 2000 V d.c. (IEC), 20 A to 600 A

Time-current curve - 170M2039 to 170M2043, 160 A to 400 A

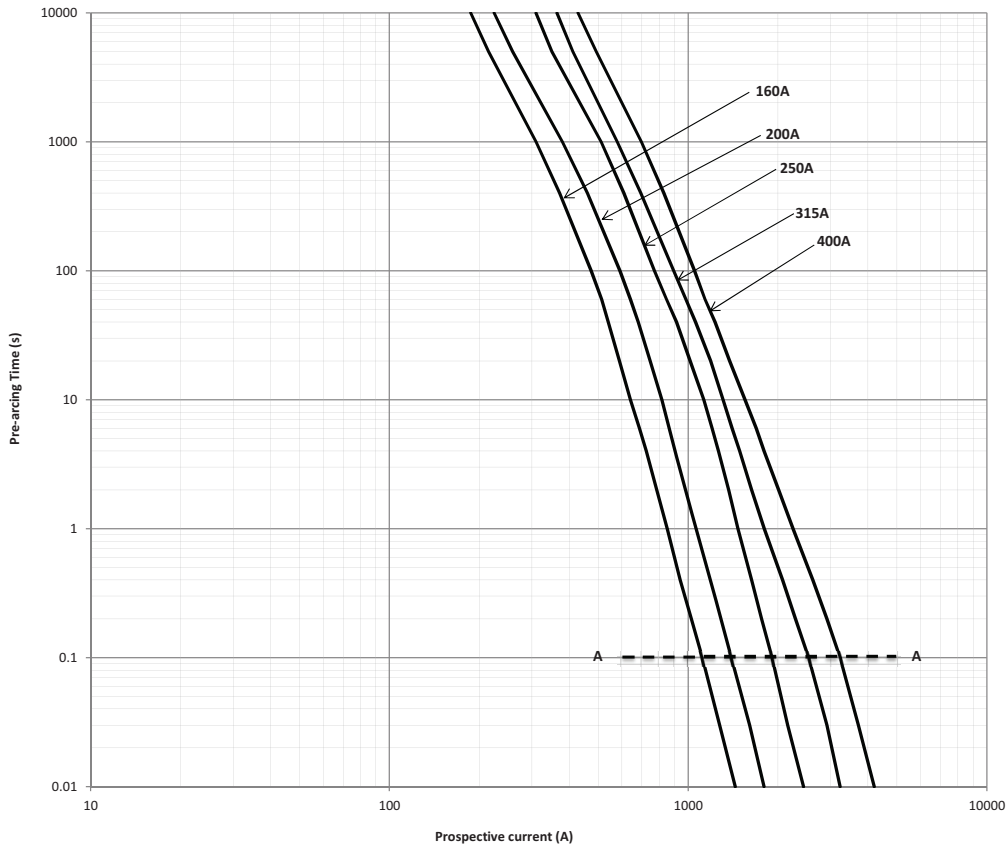

Time-current curve - 170M2044 to 170M2045, 500 A and 600 A

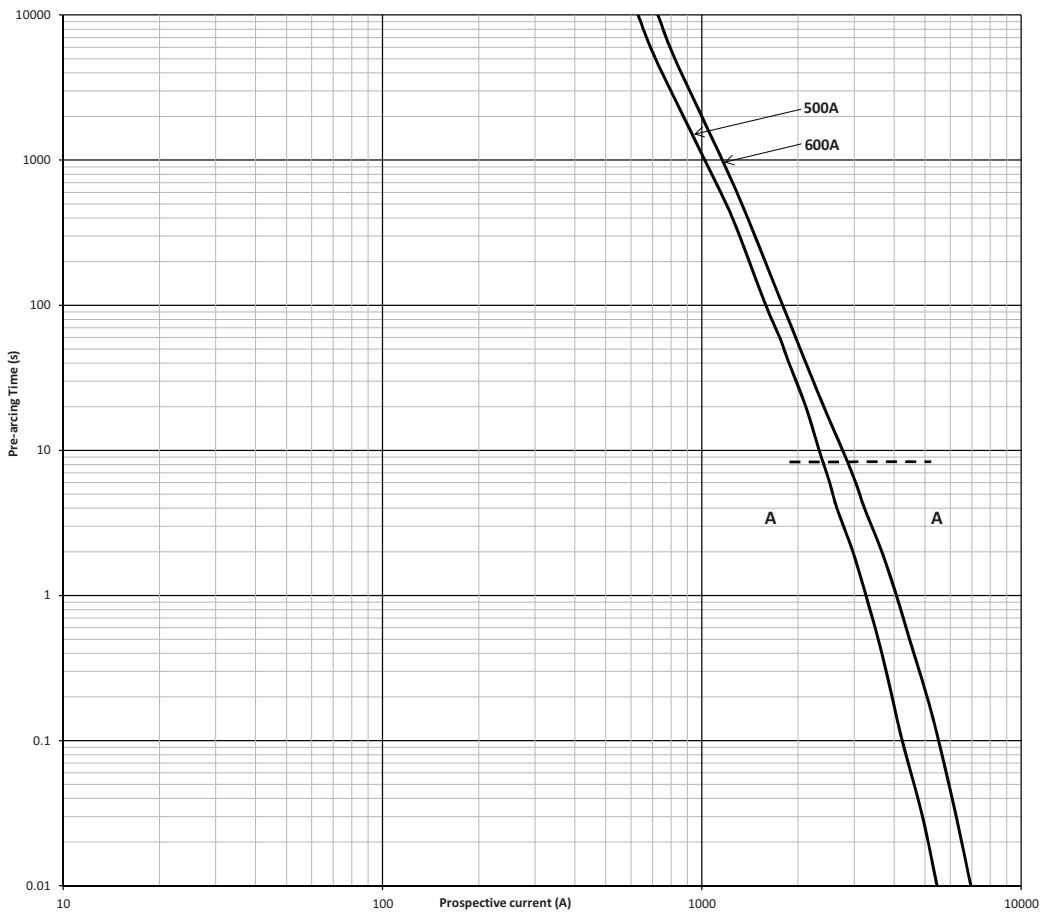

Data sheets: 720142, 5785522 (Single slot, 5785519 Double slot tag, 5785526 Parallel double slot tag)

# Traction fuse links

## 170M - Size 3, Square body fuse links, 2400 V d.c. (IEC), 100 A to 400 A

### Specifications

#### Description

Traction bolted tags square body high speed fuse links for superior protection of DC third rail applications up to 2400 V d.c.

#### Technical data

- Rated voltage: 2400 V d.c. (IEC)
- Rated current: 100 A to 400 A
- Tested breaking capacity:
  - 100 kA at 2400 V d.c., L/R < 15ms
  - 100 kA at 2000 V d.c., L/R < 45ms
- Operating class: aR

#### Standards / Agency information

Tested in line with IEC 60269



#### Catalogue numbers

Fuse link type	Fuse link body size	Rated voltage	Rated current (Amps)	I <sup>t</sup> (A <sup>2</sup> Sec)		Watts loss (W)		Catalogue numbers
				Pre-arcing	Total at 2000 V d.c.	0.8 I <sub>n</sub>	I <sub>n</sub>	
Double slot tag	3	2400 V d.c. (IEC)	100	5468	15,457	20	39	170M2090
			160	16,427	46,439	43	84	170M2091
			200	25,667	72,561	53	97	170M2092
			250	36,960	104,488	60	103	170M2093
			315	66,977	189,346	82	162	170M2094
			350	87,480	247,309	89	175	170M2095
			400	110,717	313,000	103	203	170M2096

#### Dimensions (mm)

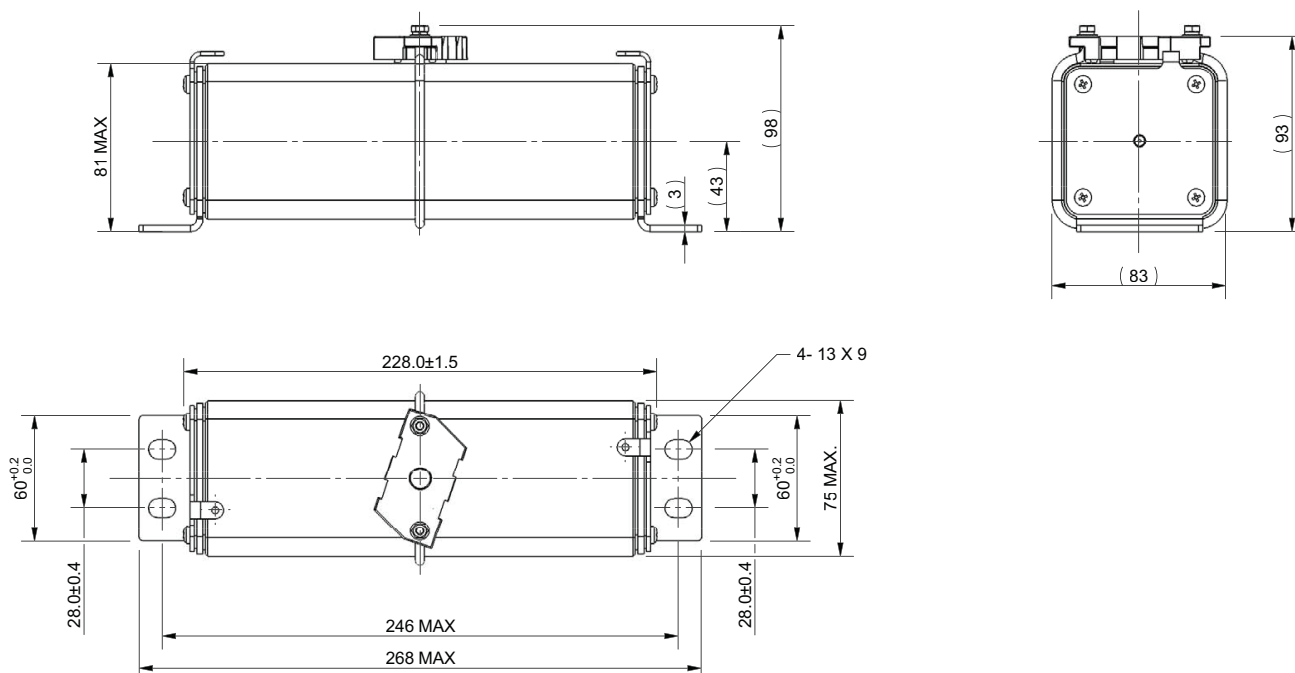



**170M - Size 3, Square body fuse links, 2400 V d.c. (IEC), 100 A to 400 A**

Time-current curve - 100 A to 400 A

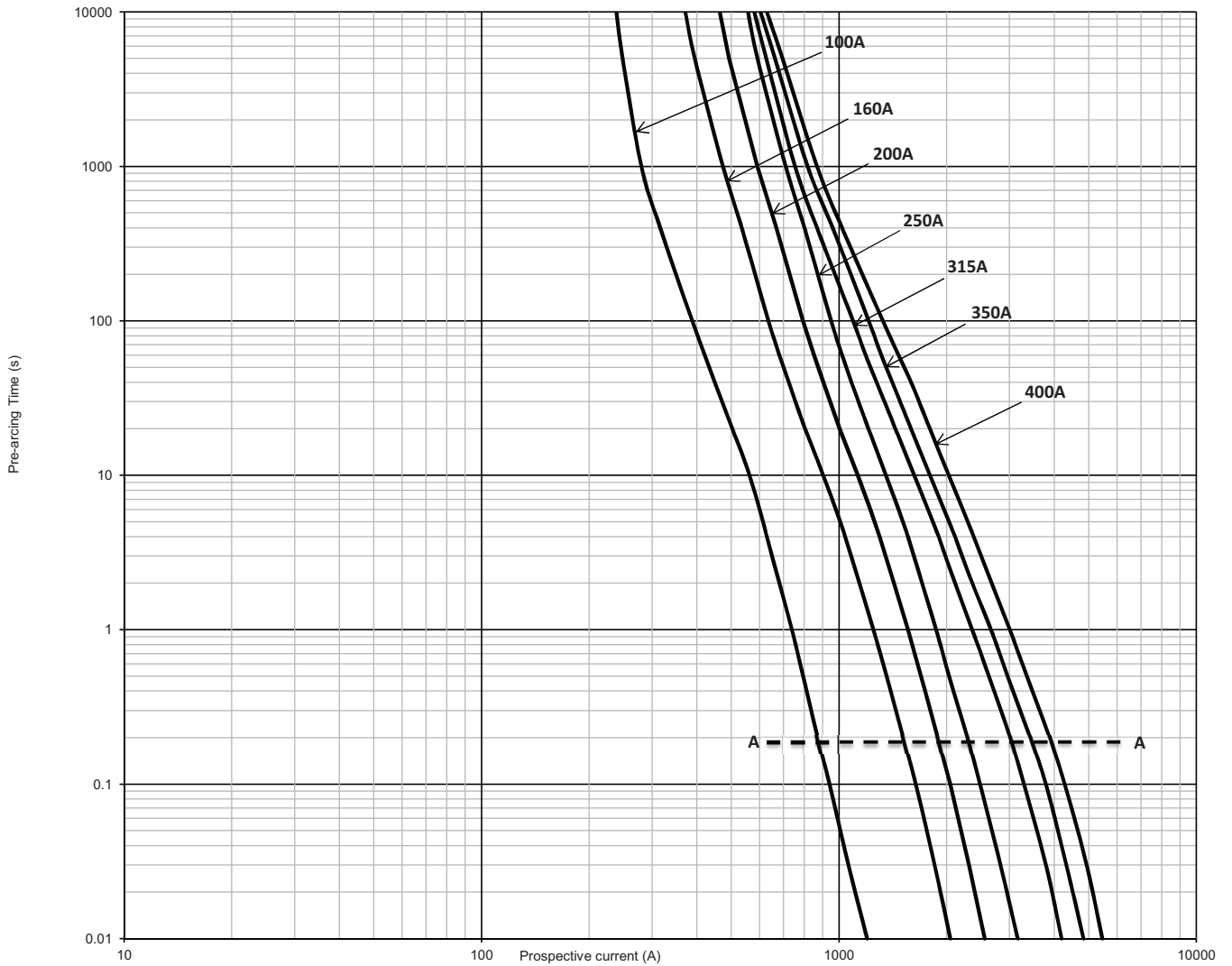

# Traction fuse links

## 170E - Size 1\*, Square body fuse links, 4000 V d.c. (IEC), 20 A to 125 A

### Specifications

#### Description

Traction bolted tags square body high speed fuse link for superior protection in DC traction applications up to 4000 V d.c.

#### Technical data

- Rated voltage: 4000 V d.c. (IEC)
- Rated current: 20 A to 125 A
- Tested breaking capacity: 50 kA at 4000 V d.c., L/R 10ms
- Operating class: aR

#### Standards / Agency information

Consult Eaton [bulehighspeedtechnical@eaton.com](mailto:bulehighspeedtechnical@eaton.com)



### Catalogue numbers

Fuse link body size	Rated voltage	Rated current (Amps)	Watts loss (W)	Catalogue numbers
1*	4000 V d.c. (IEC)	20	23	170E3924
		25	28	170E3925
		32	34	170E3926
		40	45	170E3927
		50	57	170E3928
		63	72	170E3929
		80	91	170E3930
		100	114	170E3931
		125	143	170E3932

### Dimensions (mm)

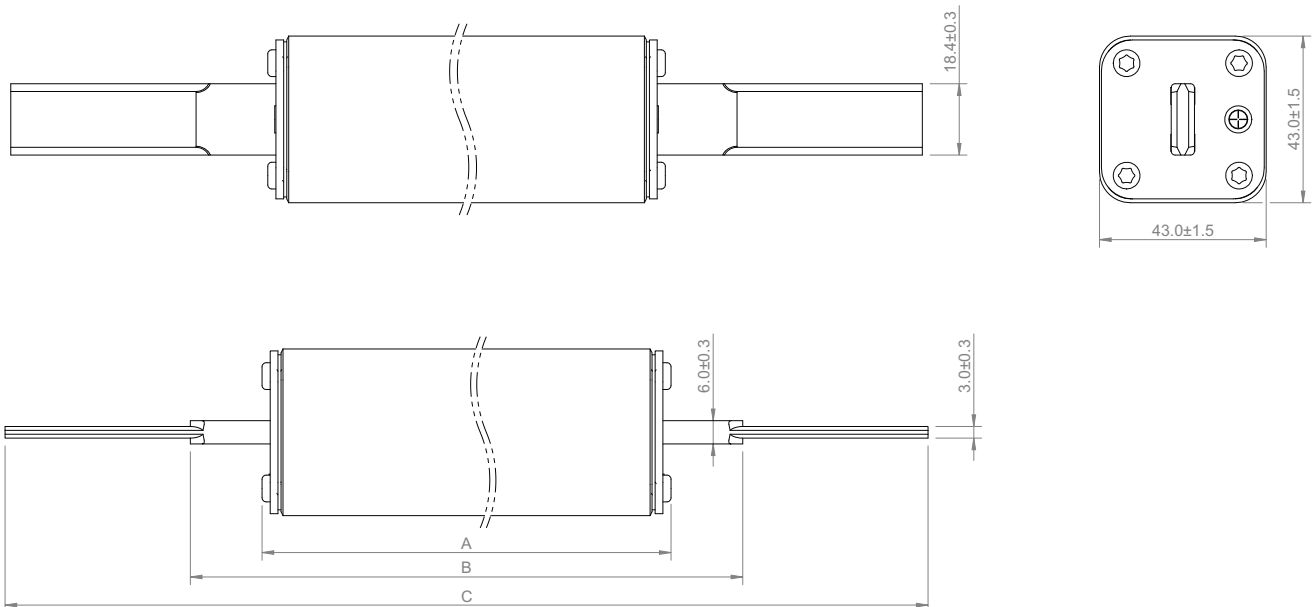

**170E - Size 1\*, Square body fuse links, 4000 V d.c. (IEC), 20 A to 125 A**

Time-current curve - 20 A to 125 A

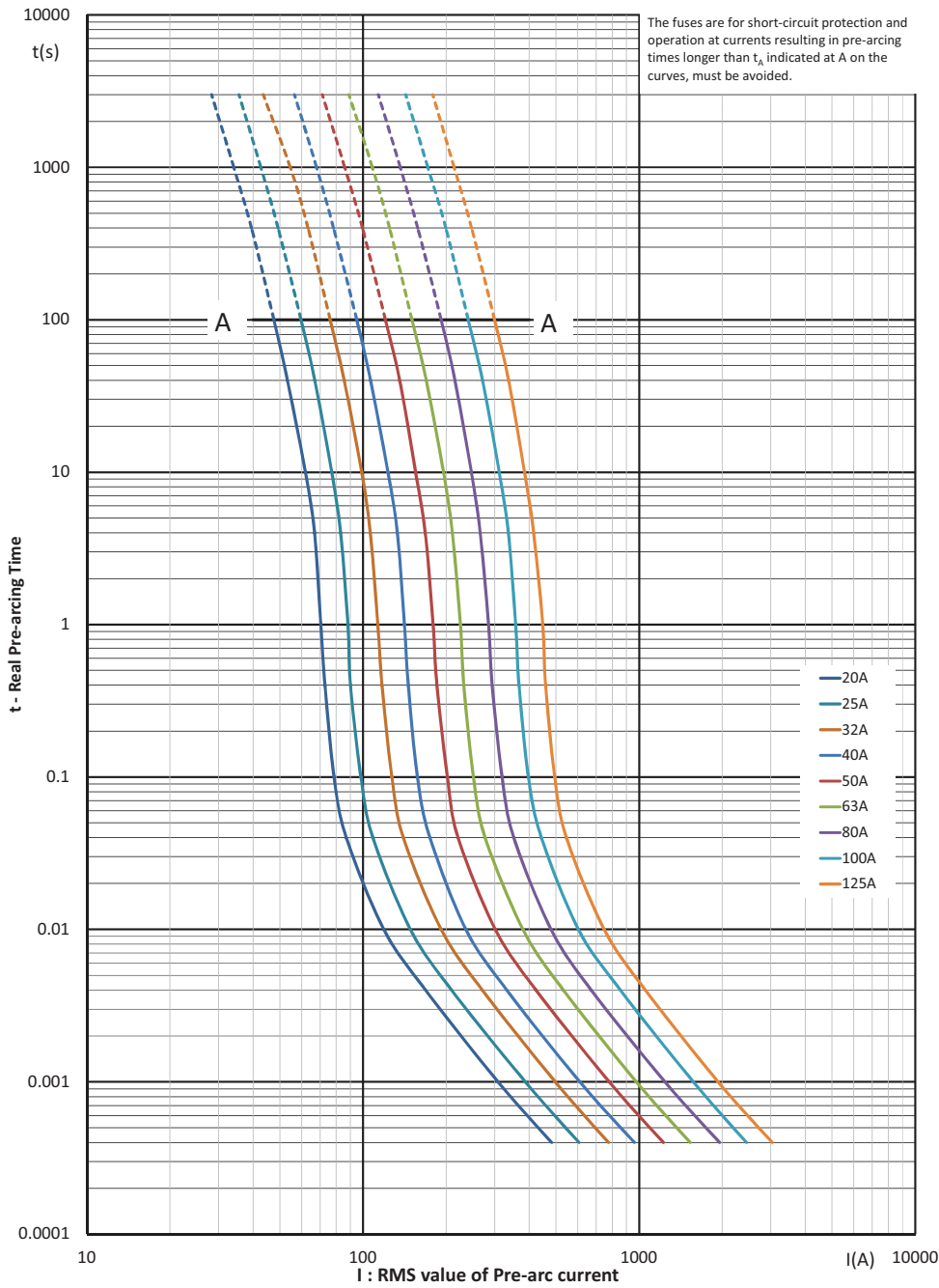

# Traction fuse links

## 170E - Size 1\*, Square body fuse links, 4000 V d.c. (IEC), 20 A to 125 A

### Cut-off curve - 20 A to 125 A

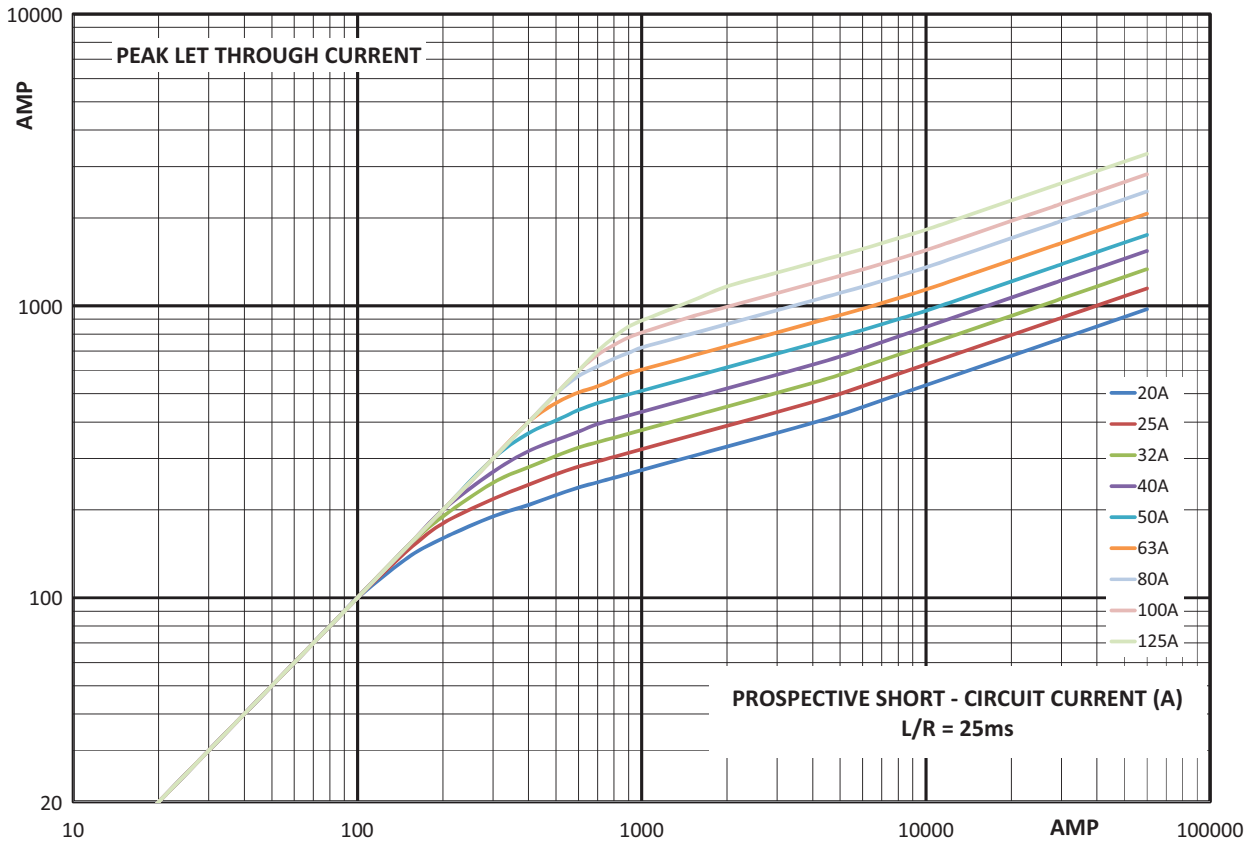

### Total clearing $I^2t$

The total clearing  $I^2t$  at rated voltage and at a power factor of 15 percent are given in the electrical characteristics. For other voltages, the clearing  $I^2t$  is found by multiplying by correction factor,  $K$ , given as a function of applied working voltage,  $E_g$ , (RMS).

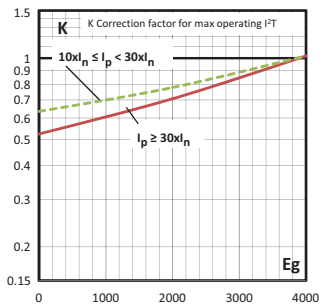

### Arc voltage

This curve gives the peak arc voltage,  $U_L$ , which may appear across the fuse during its operation as a function of the applied working voltage,  $E_g$ , (RMS) at a power factor of 15 percent.

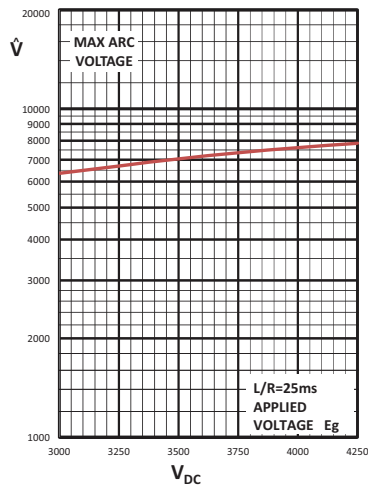

### Watts losses

Watts loss at rated current is given in the electrical characteristics. The curve allows the calculation of the watts losses at load currents lower than the rated current. The correction factor,  $K_p$ , is given as a function of the RMS load current,  $I_b$ , in percent of the rated current.

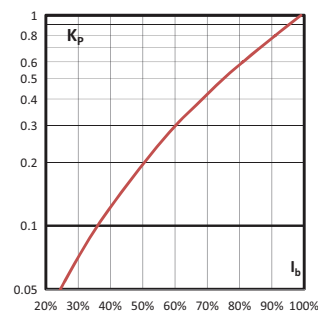

## 170E - Sizes 1\*, 2 and 2//2, Square body fuse links, 4000 V d.c. (IEC), 20 A to 450 A

### Specifications

#### Description

Traction bolted tags square body high speed fuse link for superior protection in DC traction applications up to 4000 V d.c..

#### Technical data

- Rated voltage: 4000 V d.c. (IEC)
- Rated current: 20 A to 500 A
- Breaking capacity: 60 kA at 4000 V d.c., L/R 25ms
- Operating class: aR

#### Standards / Agency information

Contact Eaton [bulehighspeedtechnical@eaton.com](mailto:bulehighspeedtechnical@eaton.com)

#### Catalogue numbers

Fuse link body size	Rated voltage	Rated current (Amps)	Watts loss (W)	Catalogue numbers
1*	4000 V d.c. (IEC)	20	23	170E3914
		25	28	170E3915
		32	34	170E3916
		40	45	170E3917
		50	57	170E3918
		63	72	170E3919
		80	91	170E3984
		100	114	170E3933
		125	143	170E3922
2	4000 V d.c. (IEC)	160	182	170E8882
		200	228	170E8883
		250	285	170E8884
		315	360	170E8885
		350	400	170E8886
2//2	4000 V d.c. (IEC)	400	455	170E8887
		450	515	170E8888
		500	600	170E8889

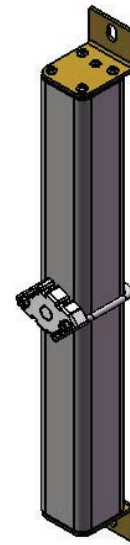

#### Dimensions (mm) - Size 1\*

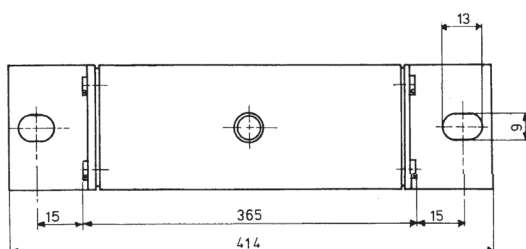
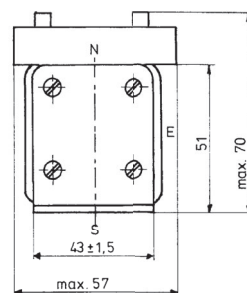
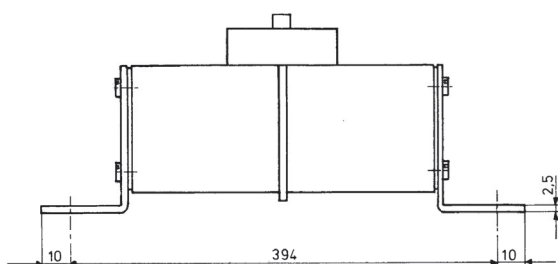

Data sheets: 1\* 170K6600, 2 and 2//2 170K6604

# Traction fuse links

## 170E - Sizes 1\*, 2 and 2//2, Square body fuse links, 4000 V d.c. (IEC), 20 A to 450 A

### Dimensions (mm) - Size 2

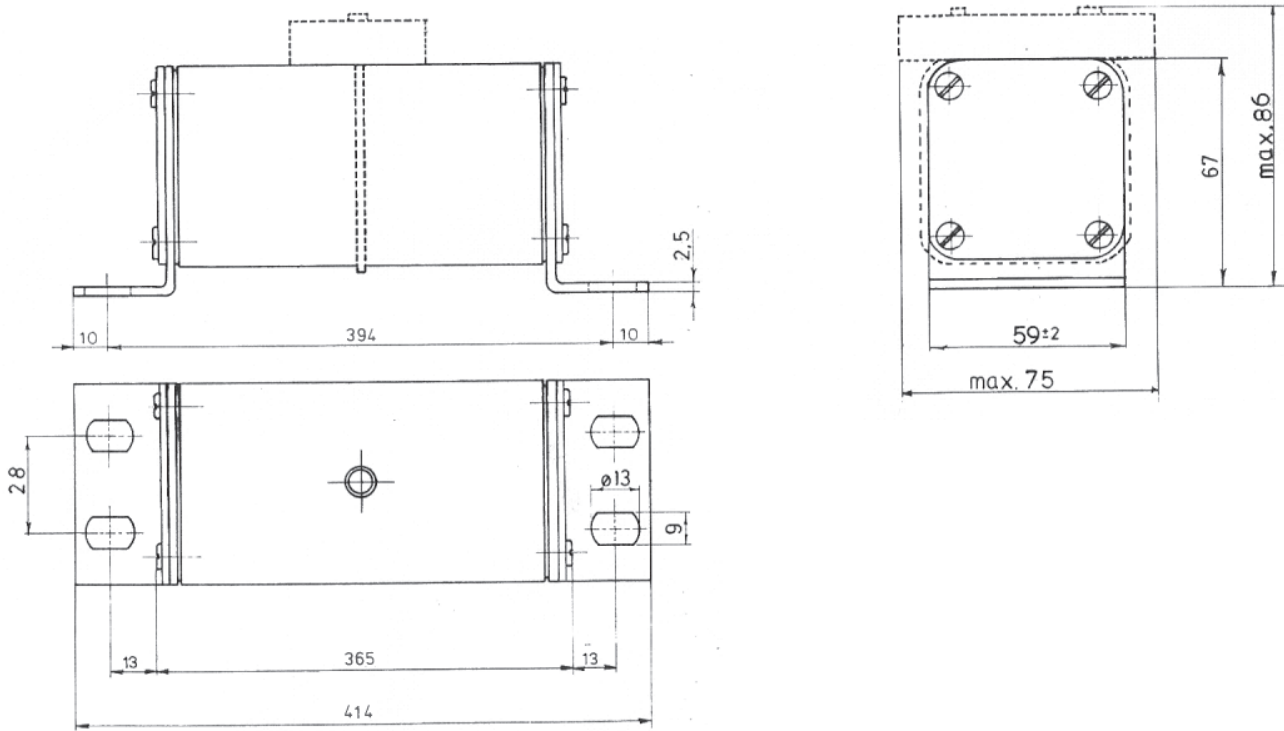

### Dimensions (mm) - Size 2//2

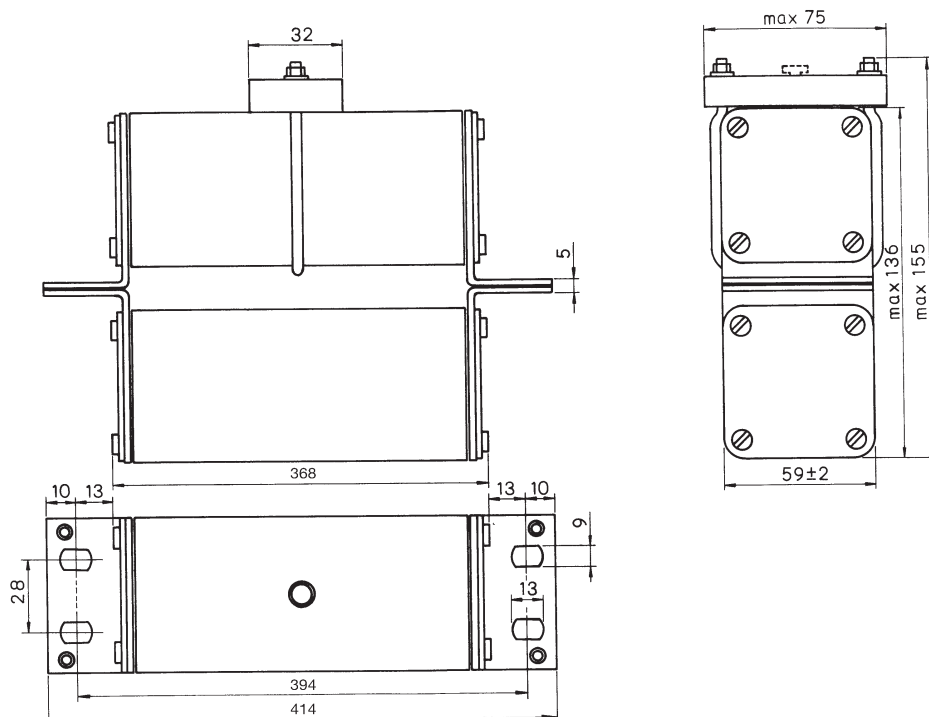

Data sheets: 1\* 170K6600, 2 and 2//2 170K6604

**170E - Sizes 1\*, 2 and 2//2, Square body fuse links, 4000 V d.c. (IEC), 20 A to 450 A**

Time-current curve - Size 1\*, 20 A to 125 A

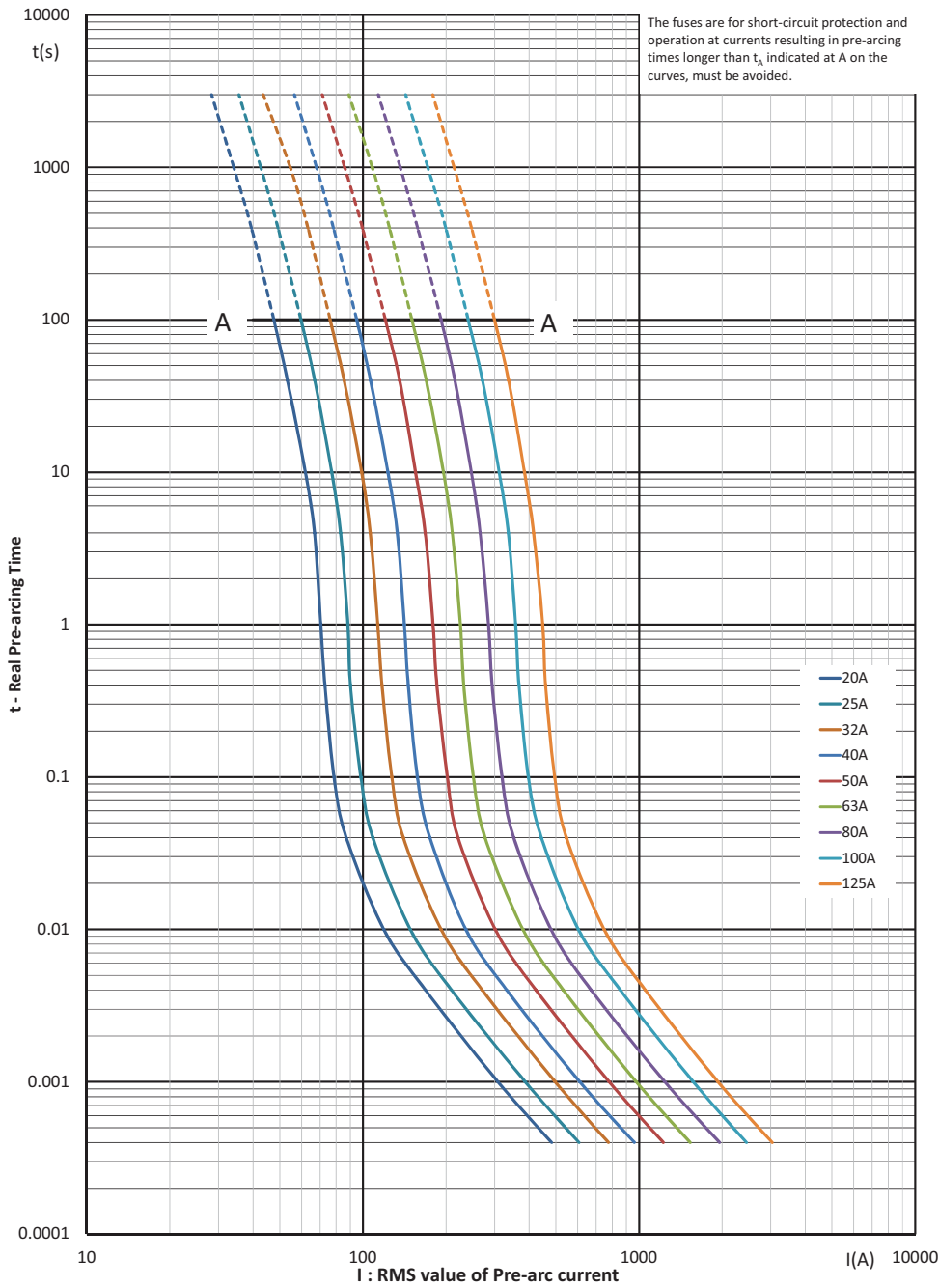

# Traction fuse links

## 170E - Sizes 1\*, 2 and 2//2, Square body fuse links, 4000 V d.c. (IEC), 20 A to 450 A

### Cut-off curve - Size 1\*, 20 A to 125 A

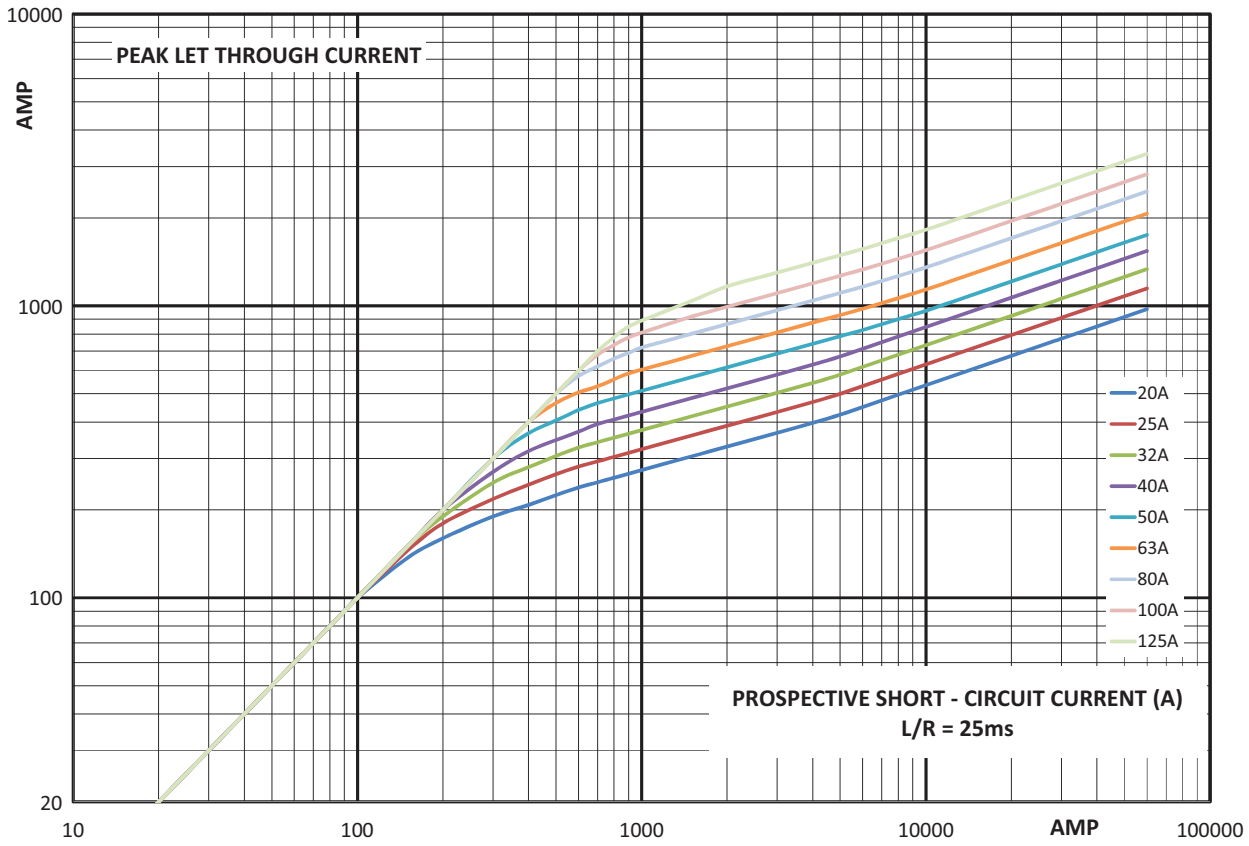

### Total clearing $I^2t$

The total clearing  $I^2t$  at rated voltage and at a power factor of 15 percent are given in the electrical characteristics. For other voltages, the clearing  $I^2t$  is found by multiplying by correction factor,  $K$ , given as a function of applied working voltage,  $E_g$ , (RMS).

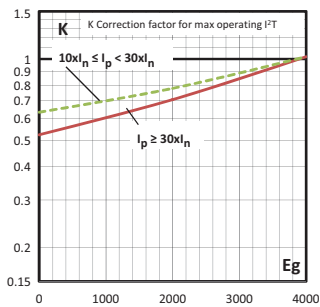

### Arc voltage

This curve gives the peak arc voltage,  $U_L$ , which may appear across the fuse during its operation as a function of the applied working voltage,  $E_g$ , (RMS) at a power factor of 15 percent.

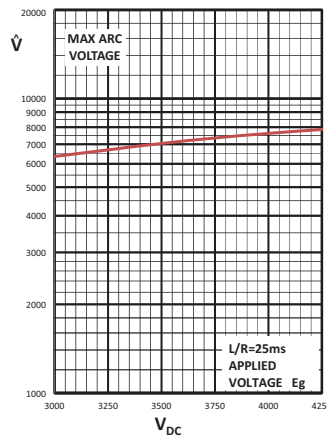

### Watts losses

Watts loss at rated current is given in the electrical characteristics. The curve allows the calculation of the watts losses at load currents lower than the rated current. The correction factor,  $K_b$ , is given as a function of the RMS load current,  $I_b$ , in percent of the rated current.

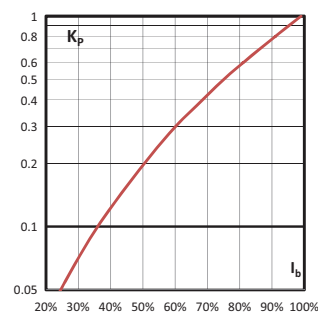



**170E - Sizes 1\*, 2 and 2//2, Square body fuse links, 4000 V d.c. (IEC), 20 A to 450 A**

Time-current curve - Sizes 2 and 2//2, 160 A to 500 A

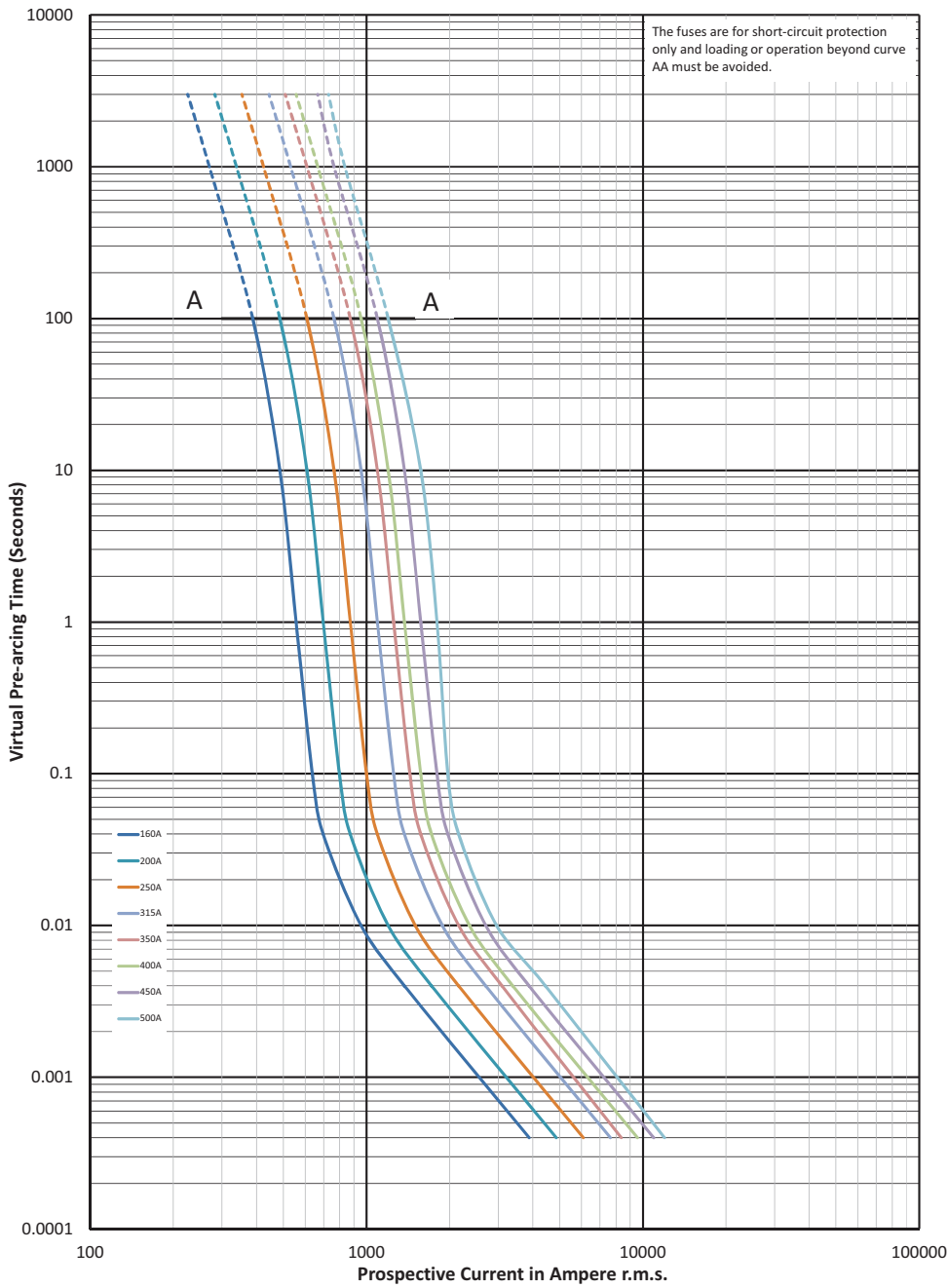

Data sheets: 1\* 170K6600, 2 and 2//2 170K6604

# Traction fuse links

## 170E - Sizes 1\*, 2 and 2//2, Square body fuse links, 4000 V d.c. (IEC), 20 A to 450 A

### Cut-off curve - Sizes 2 and 2//2, 160 A to 500 A

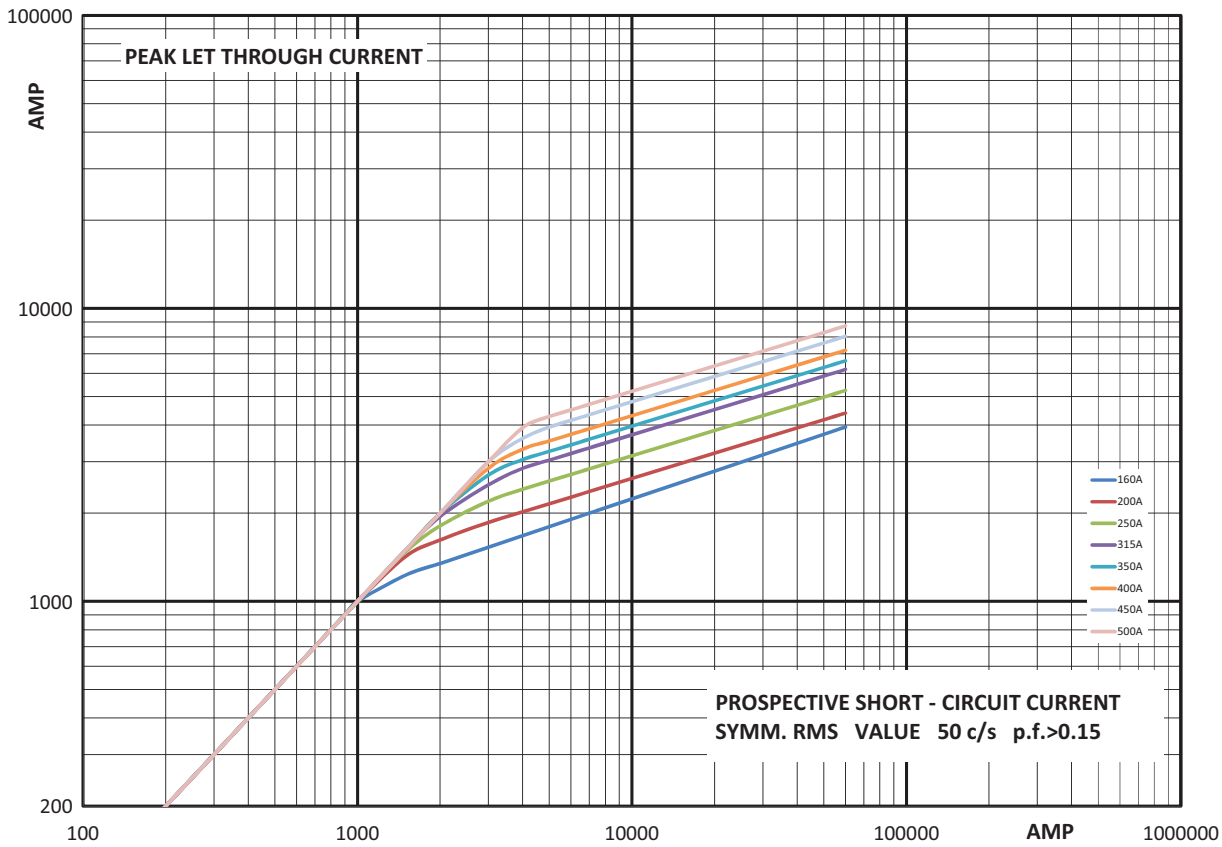

### Total clearing $I^2t$

The total clearing  $I^2t$  at rated voltage and at a power factor of 15 percent are given in the electrical characteristics. For other voltages, the clearing  $I^2t$  is found by multiplying by correction factor,  $K$ , given as a function of applied working voltage,  $E_g$ , (RMS).

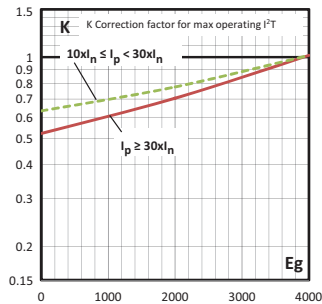

### Arc voltage

This curve gives the peak arc voltage,  $U_L$ , which may appear across the fuse during its operation as a function of the applied working voltage,  $E_g$ , (RMS) at a power factor of 15 percent.

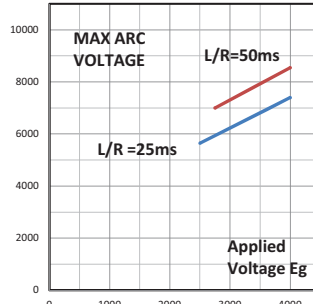

### Watts losses

Watts loss at rated current is given in the electrical characteristics. The curve allows the calculation of the watts losses at load currents lower than the rated current. The correction factor,  $K_p$ , is given as a function of the RMS load current,  $I_b$ , in percent of the rated current.

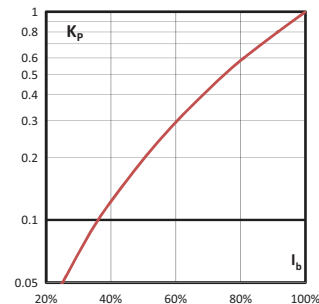

## FWK - 20 x 127 and 25 x 146 mm, Ferrule fuse links, 750 V d.c. (IEC), 5 A to 60 A

### Specifications

#### Description

Ferrule high speed fuse links for light rail applications in auxiliary power and distribution equipment.

#### Technical data

- Rated voltage: 750 V d.c. (IEC)
- Rated current:
  - 5 A to 30 A (20 x 127 mm)
  - 35 A to 60 A (25 x 146 mm)
- Breaking capacity: 50 kA at 750 V d.c., L/R 10-15ms
- Operating class: gG

#### Standards / Agency information

Tested in line with IEC 60269

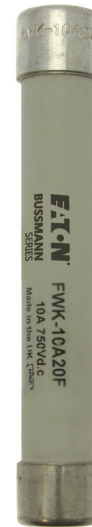

#### Catalogue numbers

Fuse link size	Rated voltage	Rated current (Amps)	I <sup>2</sup> t (A <sup>2</sup> Sec)		Watts loss (W)	Catalogue numbers
			Pre-arcing	Clearing at 750 V d.c.		
20 x 127 mm (1 <sup>3</sup> / <sub>16</sub> " x 5")	750 V d.c. (IEC)	5	8.5	16	6.7	FWK-5A20F
		8	50	100	8.8	FWK-8A20F
		10	95	200	8.5	FWK-10A20F
		15	100	240	5	FWK-15A20F
		20	125	315	7.8	FWK-20A20F
		25	400	1100	6.5	FWK-25A20F
		30	800	2600	6.5	FWK-30A20F
25 x 146 mm (1" x 5 <sup>3</sup> / <sub>4</sub> " )	750 V d.c. (IEC)	35	1300	4300	6	FWK-35A25F
		40	1600	5300	6.8	FWK-40A25F
		50	3100	12000	7.3	FWK-50A25F
		60	5900	24000	7.7	FWK-60A25F

#### Dimensions mm (in) - 5 A to 30 A

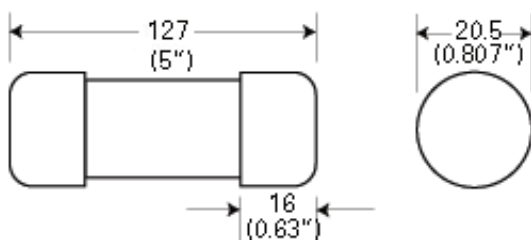

#### Dimensions mm (in) - 35 A to 60 A

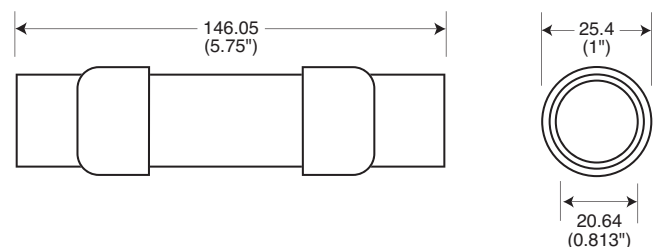

# Traction fuse links

## LRC750 - Ferrule fuse links, 750 V d.c. (IEC), 30 A to 50 A

### Specifications

#### Description

Ferrule high speed fuse links for light rail applications in auxiliary power and distribution equipment. Also suitable for heavy rails applications in instrumentation and control circuits equipment.

#### Technical data

- Rated voltage: 750 V d.c. (IEC)
- Rated current: 30 A to 50 A
- Breaking capacity: 50 kA at 750 V d.c., L/R 15-20ms
- Operating class: gR

#### Standards / Agency information

Tested in line with IEC 60269



#### Catalogue numbers

Fuse link type	Rated voltage	Rated current (Amps)	I <sup>2</sup> t (A <sup>2</sup> Sec)		Watts loss (W)	Catalogue numbers
			Pre-arcing	Clearing at 750 V d.c.		
LRC750	750 V d.c. (IEC)	30	700	2250	4.5	30LRC750
		40	1800	5300	5.8	40LRC750
		50	3100	12000	9.4	50LRC750

#### Dimensions (mm)

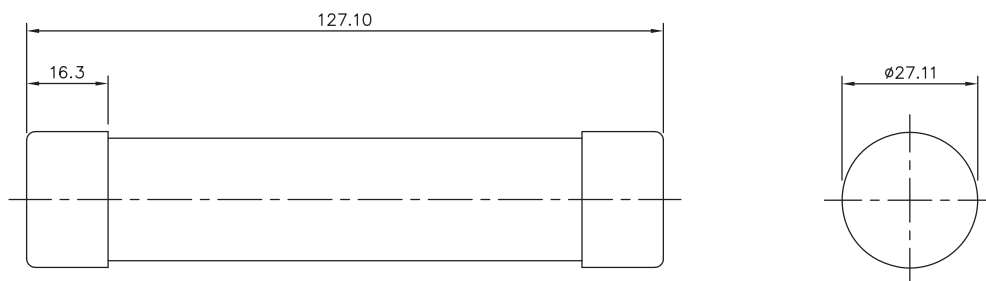

## FWL and FWS - 20 x 127 mm, Ferrule fuse links, 1200-1400-2000 V a.c. (IEC), 1000 V d.c. (IEC), 2 A to 30 A

### Specifications

#### Description

Ferrule high speed fuse links for light rail applications in auxiliary power and distribution equipment.

#### Technical data

- Rated voltage:
  - FWL: 1200 V a.c. (IEC) / 1000 V d.c.
  - FWS: 2000 V a.c. / 1000 V d.c. (IEC, 2 A to 8 A)  
1400 V a.c. / 1000 V d.c. (IEC 10 A to 15 A)
- Rated current: 2 A to 30 A
- Breaking capacity: 50 kA at 1000 V d.c., L/R 15ms
- Operating class: gG

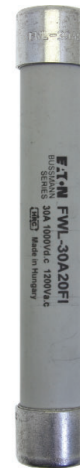

#### Standards / Agency information

Consult Eaton [bulehighspeedtechnical@eaton.com](mailto:bulehighspeedtechnical@eaton.com)

#### Catalogue numbers

Fuse link size	Rated voltage	Rated current (Amps)	I <sup>2</sup> t (A <sup>2</sup> Sec)			Catalogue numbers	
			Pre-arcing	Clearing at 1000 V d.c.	Watts loss (W)	Without indicator	With indicator
20 x 127 mm (13/16" x 5)	2000 V a.c./ 1000 V d.c. (IEC)	2	0.8	2.4	4.4	FWS-2A20F	FWS-2A20FI
		6	27	81	6.7	FWS-6A20F	FWS-6A20FI
		8	64	192	7.6	FWS-8A20F	FWS-8A20FI
	1400 V a.c./ 1000 V d.c. (IEC)	10	118	277	3.0	FWS-10A20F	FWS-10A20FI
		12	170	380	3.4	FWS-12A20F	FWS-12A20FI
		15	209	500	5.0	FWS-15A20F	FWS-15A20FI
20 x 127 mm (13/16" x 5)	1200 V a.c./ 1000 V d.c. (IEC)	20	675	1550	5.9	FWL-20A20F	FWL-20A20FI
		25	1200	2760	6.5	FWL-25A20F	FWL-25A20FI
		30	1850	4300	7.5	FWL-30A20F	FWL-30A20FI

#### Dimensions (mm)

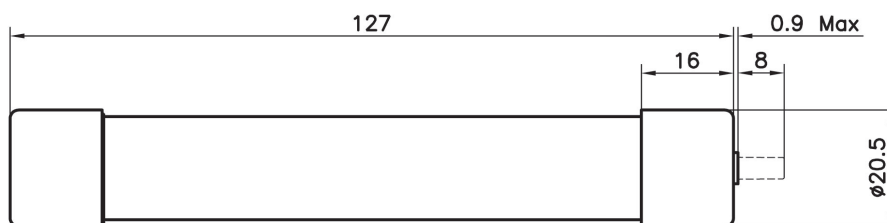

# Traction fuse links

## KC36 - Round body fuse links, 750 V d.c. (IEC), 5 A to 60 A

### Specifications

#### Description

Ferrule high speed fuse links for light rail applications in auxiliary power and distribution equipment. Also suitable for heavy rails applications in instrumentation and control circuits equipment.

#### Technical data

- Rated voltage: 750 V d.c. (IEC)
- Rated current: 5 A to 60 A
- Breaking capacity: 50 kA at 750 V d.c., L/R 15-20ms
- Operating class: gR

#### Standards / Agency information

Tested in line with IEC 60269



### Catalogue numbers

Fuse link type	Rated voltage	Rated current (Amps)	I <sup>2</sup> t (A <sup>2</sup> Sec)		Watts loss (W)	Catalogue numbers
			Pre-arcing	Clearing at 750 V d.c.		
KC36	750 V d.c. (IEC)	5	8.5	16	6.7	5KC36
		8	50	100	8.8	8KC36
		10	95	200	8.5	10KC36
		15	100	240	5	15KC36
		20	125	315	7.8	20KC36
		25	400	1100	6.5	25KC36
		30	800	2600	6.5	30KC36
		35	1300	4300	6	35KC36
		40	1600	5300	6.8	40KC36
		50	3100	12,000	7.3	50KC36
		60	5900	24,000	7.7	60KC36

### Dimensions (mm)

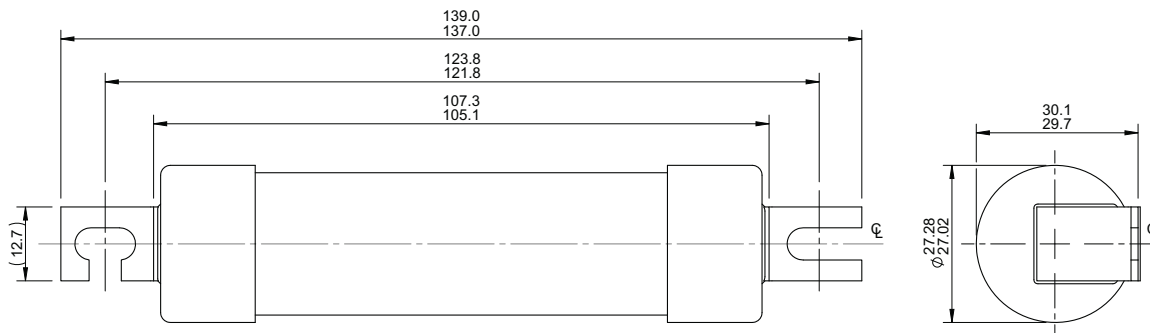

## RC - Round body fuse links, 750 V d.c. (IEC), 200 A to 400 A

### Specifications

#### Description

Round bodied bolted tags high speed traction fuse links which provides protection for DC traction third rail applications.

#### Technical data

- Rated voltage: 750 V d.c. (IEC)
- Rated current: 200 A to 400 A
- Breaking capacity: Consult Eaton  
bulehighspeedtechnical@eaton.com
- Operating class: gG

#### Standards / Agency information

Consult Eaton bulehighspeedtechnical@eaton.com



#### Catalogue numbers

Rated voltage	Rated current (Amps)	I <sup>2</sup> t (A <sup>2</sup> s)	Watts loss (W)	Catalogue numbers
750 V d.c. (IEC)	200	85,000	31	200RC
	250	225,000	33	250RC
	300	340,000	37	300RC
	350	530,000	41	350RC
	400	765,000	48	400RC

#### Dimensions (mm)

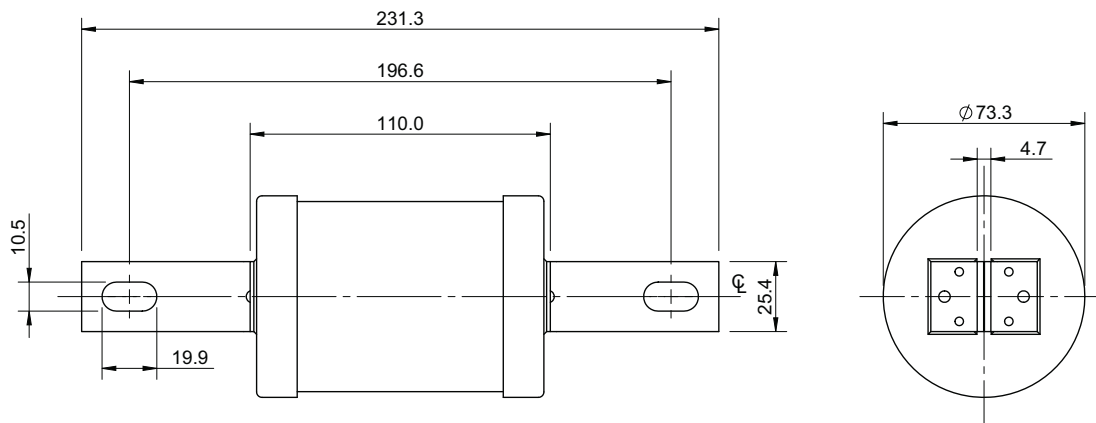

# Traction fuse links

## NBC - Round body fuse links, 1500 V d.c. (IEC), 25 A to 200 A

### Specifications

#### Description

A range of round body bolted tags high speed fuse links for heavy rail applications such as auxiliary and distribution equipment.

#### Technical data

- Rated voltage: 1500 V d.c. (IEC)
- Rated current: 25 A to 200 A
- Breaking capacity: Consult Eaton for interrupting rating and time constant capabilities.
- Operating class: gR

#### Standards / Agency information

Consult Eaton [bulehighspeedtechnical@eaton.com](mailto:bulehighspeedtechnical@eaton.com)



#### Catalogue numbers

Fuse link type	Rated voltage	Rated current (Amps)	Catalogue numbers
NBC	1500 V d.c. (IEC)	25	NBC-25
		60	NBC-60
		70	NBC-70
		100	NBC-100
		150	NBC-150
		200	NBC-200

Consult Eaton [bulehighspeedtechnical@eaton.com](mailto:bulehighspeedtechnical@eaton.com) for dimensions drawings:

25 and 60 Amps: BU-NBC-25-60

70 and 100 Amps: BU-NBC-70-100

150 and 200 Amps: BU-NBC-150 and 200



## PVM - 10 x 38 mm, 600 V d.c. (UL), 4 A to 30 A

### Specifications

#### Description

A range of UL 2579 fast-acting 600 V d.c. midget fuse links specifically designed to protect solar power systems in extreme ambient temperature, high cycling and low level fault Rated current conditions (reverse rated current, multi-array fault).

#### Technical data

- Rated voltage: 600 V d.c. to UL 2579
- Rated current: 4 A to 30 A
- Breaking capacity: 50 kA DC (4 A to 30 A)

#### Compatible fuse holder

CHPV

#### Standards / Agency information

UL Listed 2579, Guide JFGA, File E335324, CSA Component Certified C22.2

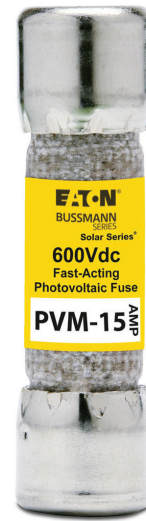

#### Catalogue numbers

Rated voltage	Rated current (Amps)	Power Loss (W)		Catalogue numbers
		0.8 x I <sub>n</sub>	1 x I <sub>n</sub>	
600 V d.c. (UL)	4			PVM-4
	5			PVM-5
	6			PVM-6
	7			PVM-7
	8			PVM-8
	9			PVM-9
	10	1	1.9	PVM-10
	12			PVM-12
	15	1	1.7	PVM-15
	20			PVM-20
	25			PVM-25
	30	1.6	2.9	PVM-30

Please contact [FUSETECH@eaton.com](mailto:FUSETECH@eaton.com) for further information

#### Dimensions in (mm)

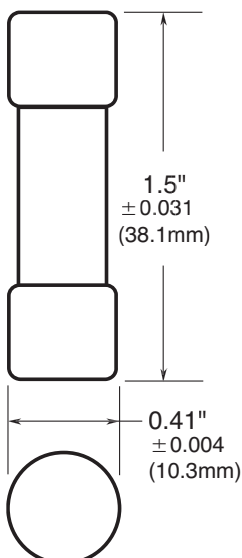

# Photovoltaic fuse links, fuse bases and holders

## PVM - 10 x 38 mm, 600 V d.c. (UL), 4 A to 30 A

Time-current curve - 5 A to 30 A

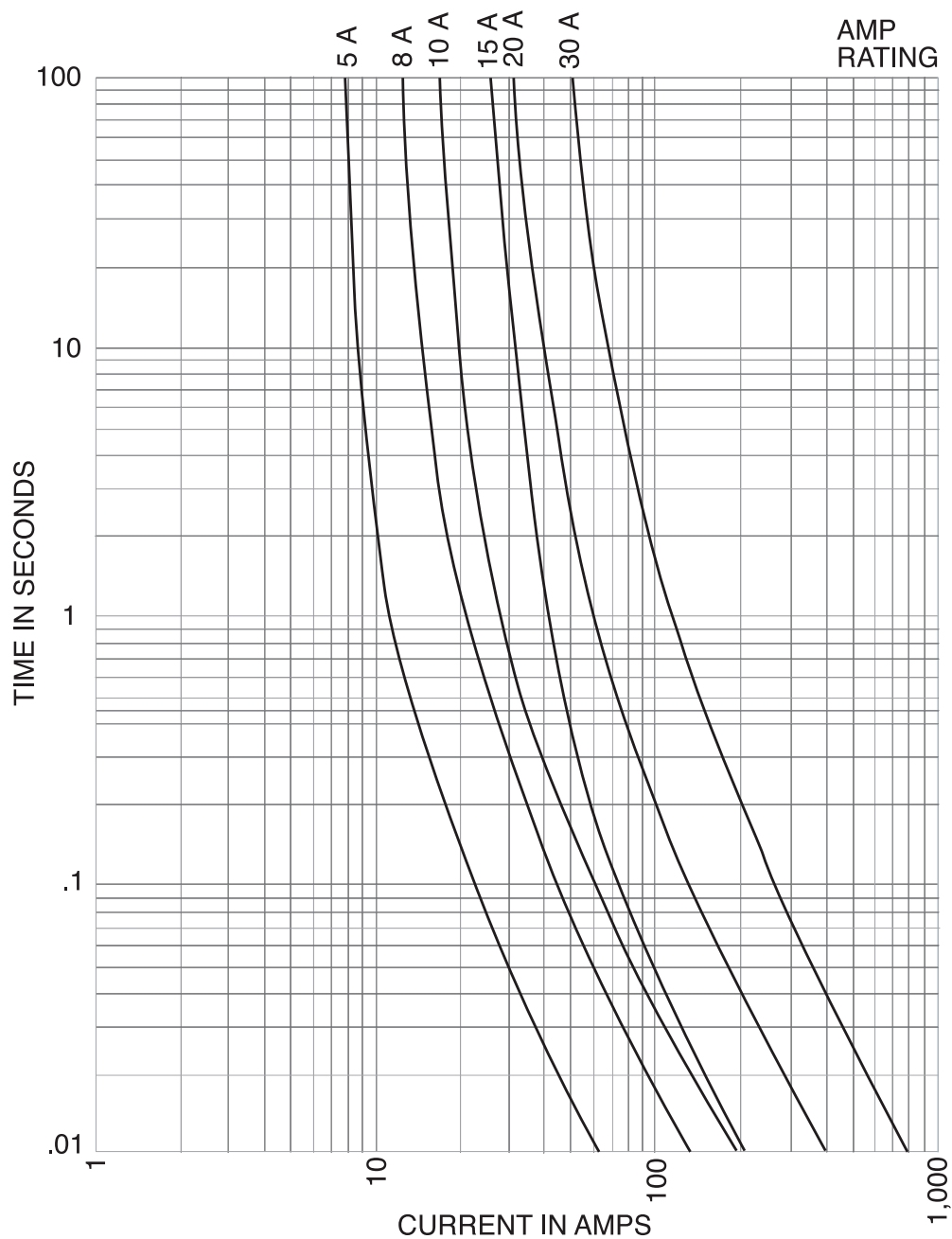

Please contact [FUSETECH@eaton.com](mailto:FUSETECH@eaton.com) for further information

**PV-A10 - 10 x 38 mm, 1000 V d.c. (IEC/UL), 1 A to 20 A**
**Specifications**
**Description**

A range of fuse links in a 10 x 38 mm package specifically designed for the protection and isolation of photovoltaic strings. The fuse links are capable of interrupting low over rated currents associated with faulted PV (reverse rated current, multi-array fault) string arrays.

**Technical data**

- Rated voltage: 1000 V d.c. (IEC/UL)
- Rated current: 1 A to 20 A
- Breaking capacity: 50 kA
- Operating class: gPV and UL PV fuse links

**Compatible fuse holder**

CHPV

**Standards / Agency information**

IEC 60269-6, UL Recognised 2579 (File number E335324), CSA, CCC (1-15A), RoHS compliant.

**Catalogue numbers - Cylindrical and bolt fixing fuse links**

Rated voltage	Rated current (Amps)	I <sup>2</sup> t (A <sup>2</sup> Sec)		Watts loss (W)		Catalogue numbers	
		Pre-arcing	Total at 1000 V d.c.	0.8 I <sub>n</sub>	I <sub>n</sub>	Cylindrical	Bolt fixing
1000 V d.c. (UL/IEC)	1	0.2	0.4	0.8	1.5	PV-1A10F	PV-1A10-T
	2	1.2	4	0.6	1.0	PV-2A10F	PV-2A10-T
	2.5	3	9	0.6	1.0	PV-2-5A10F	PV-2-5A10-T
	3	4	11	0.8	1.3	PV-3A10F	PV-3A10-T
	3.5	6.6	18	0.9	1.4	PV-3-5A10F	PV-3-5A10-T
	4	9.5	26	1.0	1.5	PV-4A10F	PV-4A10-T
	5	19	50	1.0	1.6	PV-5A10F	PV-5A10-T
	6	30	90	1.1	1.8	PV-6A10F	PV-6A10-T
	8	3	32	1.2	2.1	PV-8A10F	PV-8A10-T
	10	7	70	1.2	2.3	PV-10A10F	PV-10A10-T
	12	12	120	1.5	2.7	PV-12A10F	PV-12A10-T
	15	15	160	1.7	2.9	PV-15A10F	PV-15A10-T
	16	19	200	1.8	3	PV-16A10F	PV-16A10-T
	20	34	350	2.1	3.6	PV-20A10F	PV-20A10-T

**Catalogue numbers - PCB fixing fuse links**

Rated voltage	Rated current (Amps)	I <sup>2</sup> t (A <sup>2</sup> Sec)		Watts loss (W)		Catalogue numbers		
		Pre-arcing	Total at 1000 V d.c.	0.8 I <sub>n</sub>	I <sub>n</sub>	PCB fixing single pin	PCB fixing double pin	PCB fixing double pin silver cap
1000 V d.c. (UL/IEC)	1	0.2	0.4	0.8	1.5	PV-1A10-1P	PV-1A10-2P	PV-1A10-2P-S
	2	1.2	4	0.6	1.0	PV-2A10-1P	PV-2A10-2P	PV-2A10-2P-S
	2.5	3	9	0.6	1.0	PV-2-5A10-1P	PV-2-5A10-2P	PV-2-5A10-2P-S
	3	4	11	0.8	1.3	PV-3A10-1P	PV-3A10-2P	PV-3A10-2P-S
	3.5	6.6	18	0.9	1.4	PV-3-5A10-1P	PV-3-5A10-2P	PV-3-5A10-2P-S
	4	9.5	26	1.0	1.5	PV-4A10-1P	PV-4A10-2P	PV-4A10-2P-S
	5	19	50	1.0	1.6	PV-5A10-1P	PV-5A10-2P	PV-5A10-2P-S
	6	30	90	1.1	1.8	PV-6A10-1P	PV-6A10-2P	PV-6A10-2P-S
	8	3	32	1.2	2.1	PV-8A10-1P	PV-8A10-2P	PV-8A10-2P-S
	10	7	70	1.2	2.3	PV-10A10-1P	PV-10A10-2P	PV-10A10-2P-S
	12	12	120	1.5	2.7	PV-12A10-1P	PV-12A10-2P	PV-12A10-2P-S
	15	15	160	1.7	2.9	PV-15A10-1P	PV-15A10-2P	PV-15A10-2P-S
	16	19	200	1.8	3	PV-16A10-1P	PV-16A10-2P	PV-16A10-2P-S
	20	34	350	2.1	3.6	PV-20A10-1P	PV-20A10-2P	PV-20A10-2P-S

Data sheet: 720110

# Photovoltaic fuse links, fuse bases and holders

## PV-A10 - 10 x 38 mm, 1000 V d.c. (IEC/UL), 1 A to 20 A

### Dimensions (mm) - PV-\*\*A10F, Cylindrical

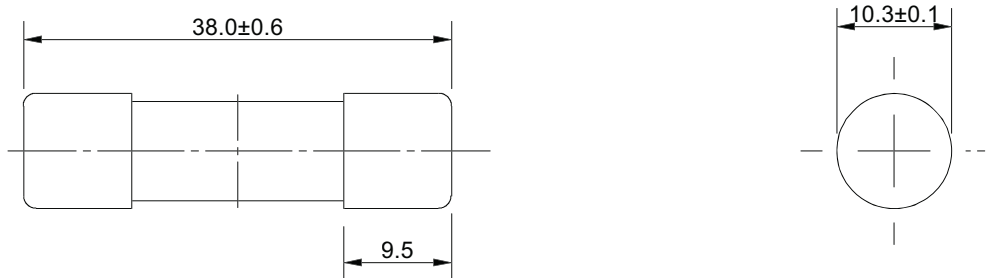

### Dimensions (mm) - PV-\*\*A10-xP, PCB fixing

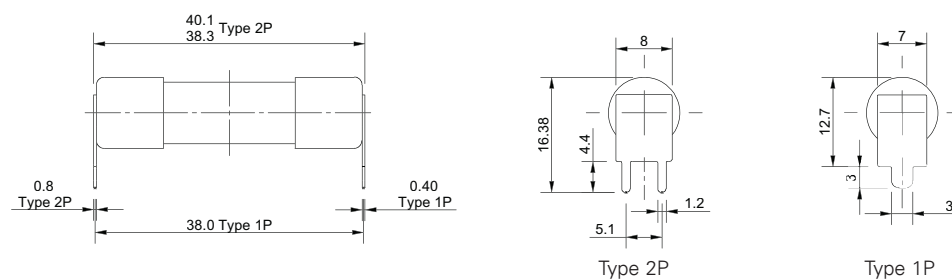

### Dimensions (mm) - PV-\*\*A10-T, Bolt fixing

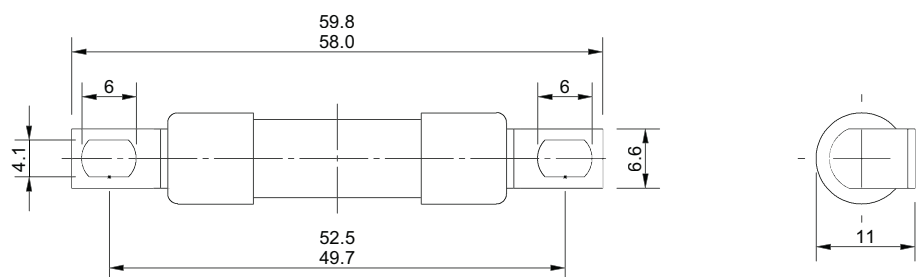

**PV-A10 - 10 x 38 mm, 1000 V d.c. (IEC/UL), 1 A to 20 A**

Time-current curve - 1 A to 20 A

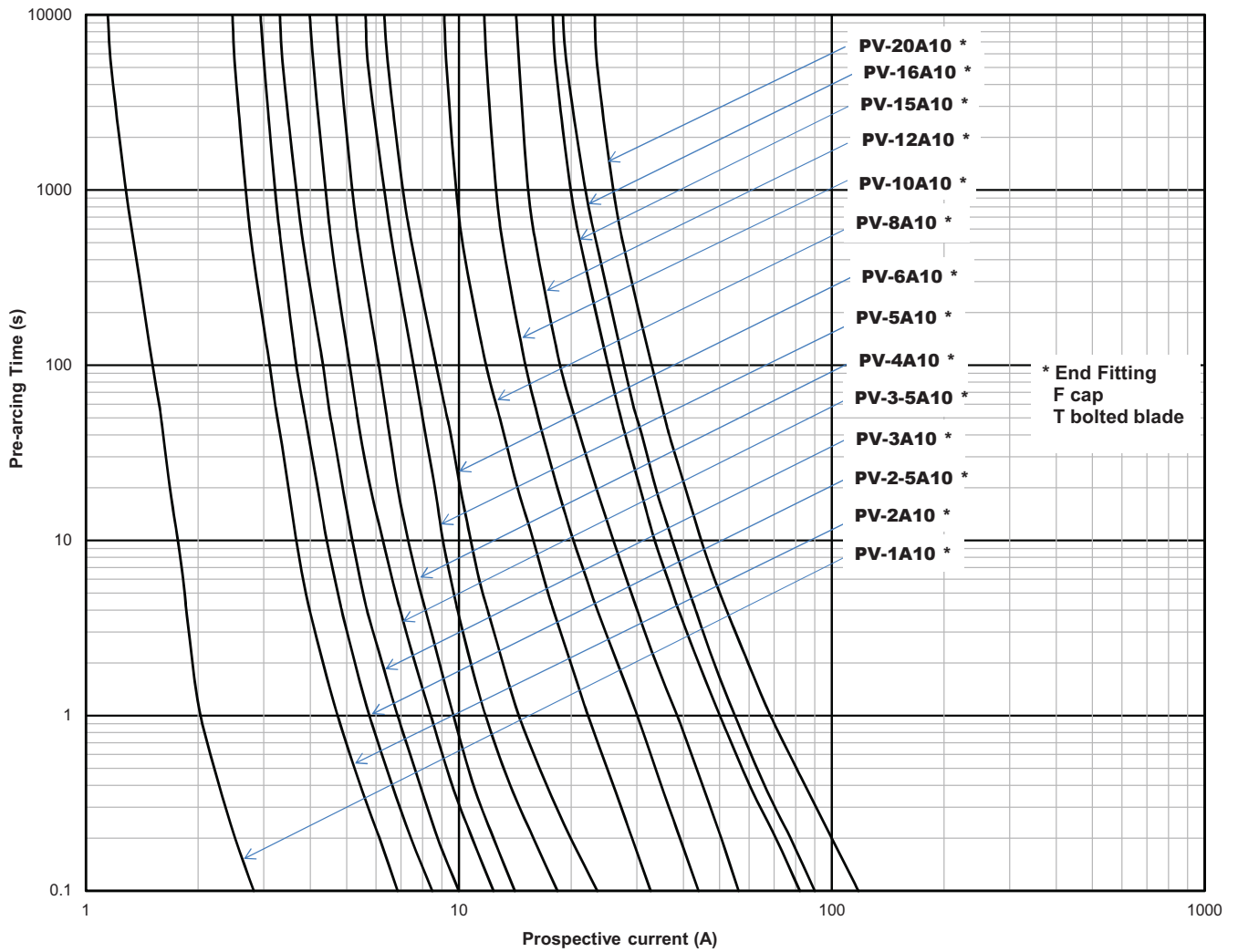

Temperature deratings

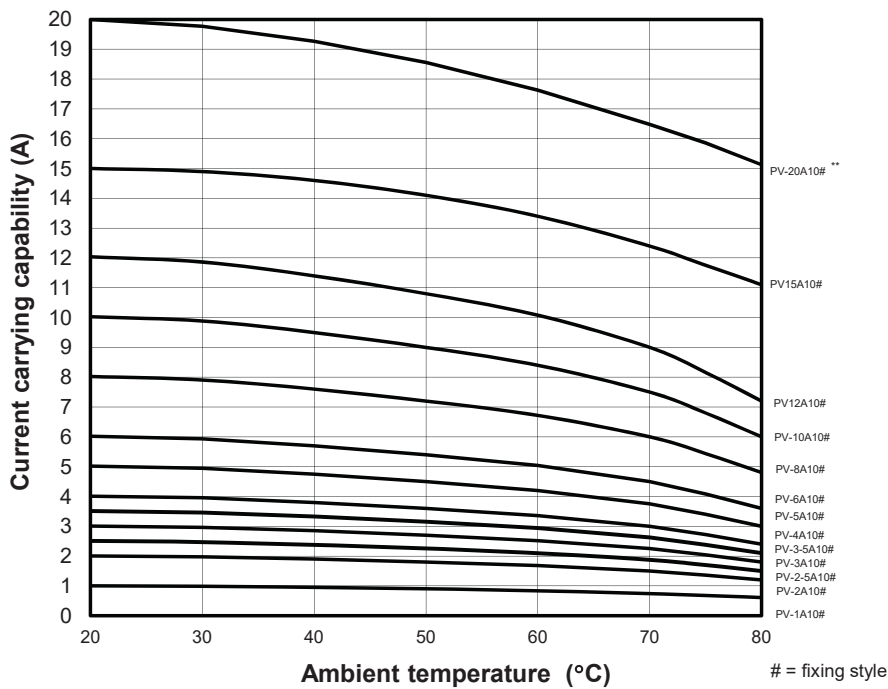

# Photovoltaic fuse links, fuse bases and holders

## CHPV - Modular fuse holders, 1000 V d.c. (IEC/UL), 32 A (IEC), 30 A (UL)

### Specifications

#### Description

Compact DIN-Rail mounting fuse holders specifically designed for 10 x 38 mm photovoltaic fuse links.

#### Catalogue numbers

- CHPV1U 1-pole modular fuse holder
- CHPV2U 2-pole modular fuse holder
- CHPV1IU 1-pole modular fuse holder with neon indicator
- CHPV2IU 2-pole modular fuse holder with neon indicator



#### Technical data

IEC		UL		Terminal rating	Rated breaking withstand capacity	Compatible Bussmann series fuse links
Rated voltage	Rated current	Rated voltage	Rated current			
1000 V d.c.	32 A	1000 V d.c.	30 A	IEC 1 to 25 mm <sup>2</sup> 70°C PVC Copper cable (solid stranded or fine stranded) Spade lug Comb bus bar	33 kA rms sym	Solar PV range: PVM, PV-A10F

#### Standards / Agency information

IEC	UL	CSA	CCC	CE
IEC 60269-1	UL 4248-1 UL4248-19 UL file E14853	C22.2 No 4248.1 C22.2 No 4248.19	GB 13539.1	DCB 272

#### Dimensions mm (in)

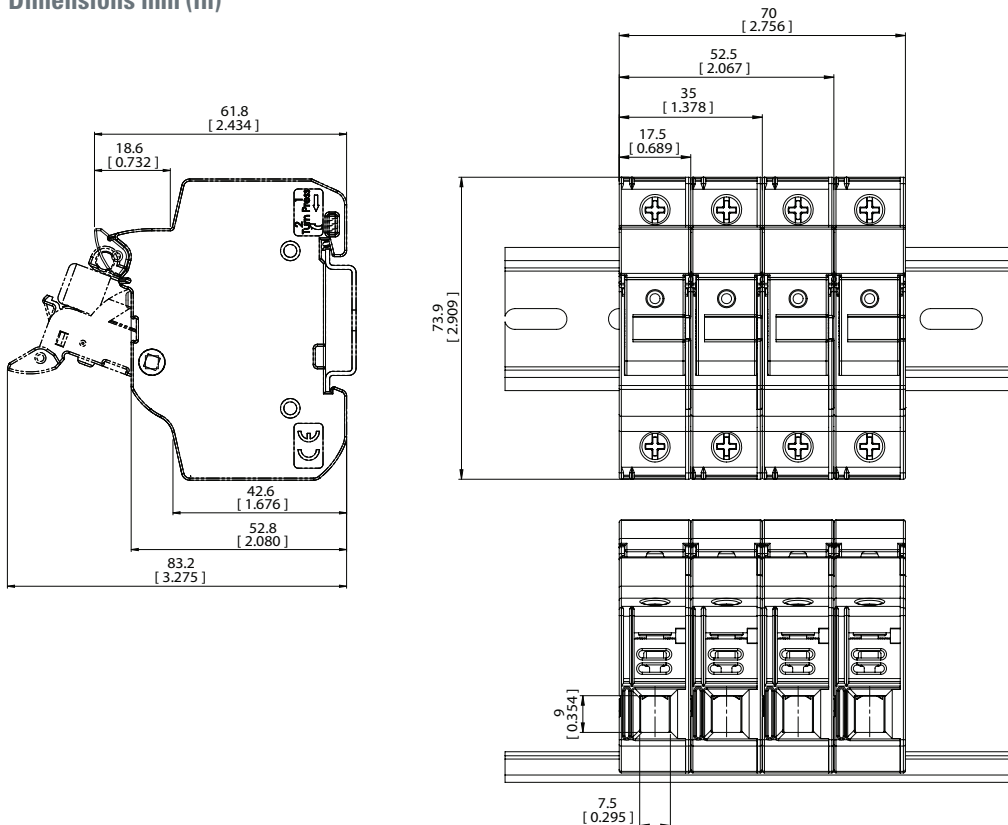

## PV-A10F85L - 10 x 85 mm, 1500 V d.c. (IEC/UL), 2.25 A to 30 A

### Specifications

#### Description

A range of fuse links in a 10 x 85 mm package specifically designed for the protection and isolation of photovoltaic strings.

#### Technical data

- Rated voltage: 1500 V d.c.
- Rated current: 2.25 A to 30 A
- Breaking capacity: 30 kA 1 ms
- Operating class: gPV

#### Compatible fuse holder

CHPV15L85

#### Standards / Agency information

IEC 60269-6, UL 248-19, RoHS compliant



#### Catalogue numbers

Rated voltage	Rated current (Amps)	I <sup>2</sup> t (A <sup>2</sup> Sec)		Watts loss (W)		Catalogue numbers
		Pre-arcing	Total at 1500 V d.c.	0.8 I <sub>n</sub>	I <sub>n</sub>	
1500 V d.c. (IEC/UL)	2.25	3	10	1.4	2.4	PV-2-25A10F85L
	2.5	4	10	1.3	2.1	PV-2.5A10F85L
	3	7	20	1.3	2.2	PV-3A10F85L
	3.5	10	20	1.6	2.6	PV-3.5A10F85L
	4	15	30	1.7	2.8	PV-4A10F85L
	5	33	60	1.7	2.8	PV-5A10F85L
	12	19	240	2.1	3.5	PV-12A10F85L
	15	42	300	2.2	3.6	PV-15A10F85L
	16	48	350	2.1	3.5	PV-16A10F85L
	20	108	800	2.7	4.5	PV-20A10F85L
	25	190	1400	3.4	5.6	PV-25A10F85L
	30	485	3500	4	6.6	PV-30A10F85L

#### Dimensions (mm)

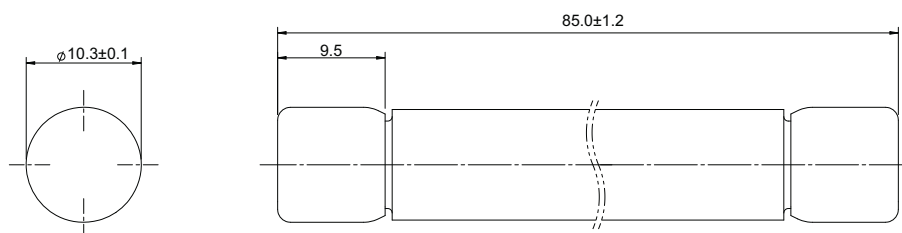

# Photovoltaic fuse links, fuse bases and holders

## PV-A10F85L - 10 x 85 mm, 1500 V d.c. (IEC/UL), 2.25 A to 30 A

Time-current curve - 2.25 A to 30 A

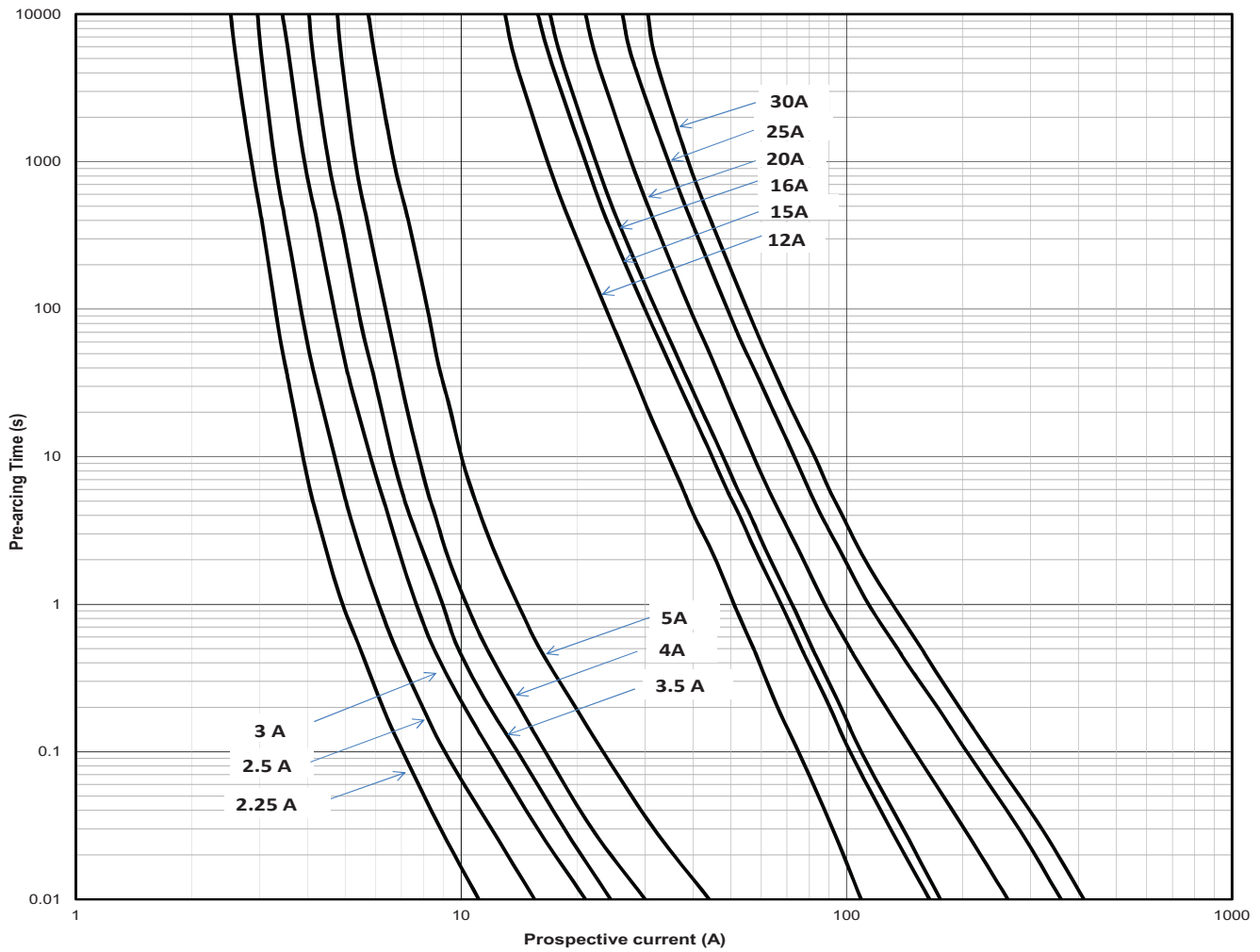



## CHPV15H85 -10 x 85 mm fuse holder, 1500 V d.c.. 32 A (IEC/UL)

### Specifications

#### Description

Eaton's Bussmann series 10 x 85 mm fuse holders are suitable for use with 10 x 85 mm and 14 x 85 mm cylindrical gPV fuse links. The unique design offers high degree of safety. There is no possibility of any accidental contact with live parts during replacement of the fuse links. When the fuse carrier is extracted, a spring loaded cover moves out covering the live parts hence protecting against accidental damage.

#### Catalogue symbol

CHPV15H85

#### Compatible fuse links

- 10 x 85 mm fuse links - PV-A10F85L
- 14 x 85 mm fuse links - PV-A14LF

#### Technical data

- Rated voltage: 1500 V d.c.
- Rated current: 32 A (IEC/UL)
- Breaking capacity: 50 kA

#### Standards / Agency information

- IIEC 60269-1
- IEC 60269-6
- UL 4248-1 Edition 1 (File number 348242)
- UL 4248-19 Edition 1



#### Dimensions (mm)

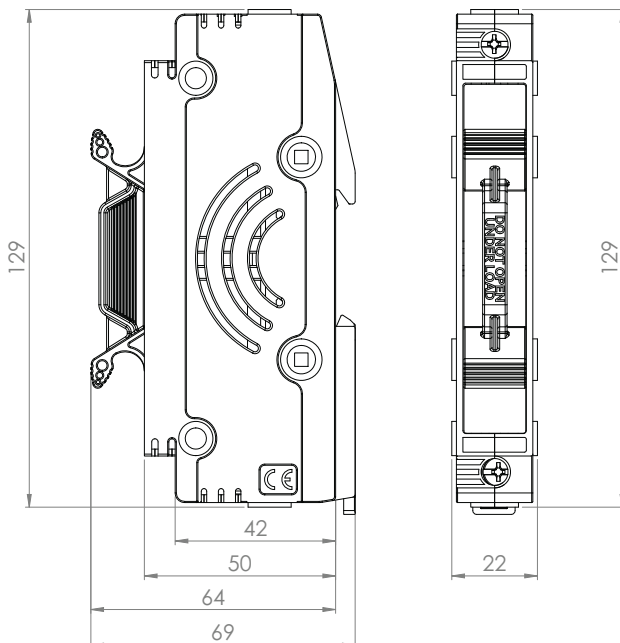

# Photovoltaic fuse links, fuse bases and holders

## PV-14F - 14 x 51 mm, 1000 and 1100 V d.c. (IEC/UL), 15 A to 32 A

### Specifications

#### Description

A range of fuse links in a 14 x 51 mm package specifically designed for the protection and isolation of photovoltaic strings. The fuse links are capable of interrupting low overrated currents associated with faulted PV (reverse rated current, multi-array fault).

#### Technical data

- Rated voltage:
  - 1100 V d.c. (IEC and UL, 15 A and 20 A)
  - 1000 V d.c. (IEC and UL, 25 A and 32 A)
- Rated current: 15 A to 32 A
- Breaking capacity: 30 kA
- Operating class: gPV and UL PV fuse links

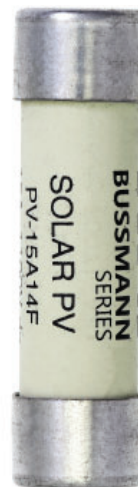

#### Compatible fuse holder

- CHPV14

#### Standards / Agency information

IIEC 60269-6, UL Recognised 2579 (File number E335324), RoHS compliant. Pending: CCC

#### Catalogue numbers

Rated voltage	Rated current (Amps)	I <sup>2</sup> t (A <sup>2</sup> Sec)		Watts loss (W)		Catalogue numbers
		Pre-arcing	Total at rated voltage	0.8 I <sub>n</sub>	I <sub>n</sub>	
1100 V d.c. (IEC/UL)	15	14	270	2.1	4	PV-15A14F
	20	27	570	2.9	5.5	PV-20A14F
1000 V d.c. (IEC/UL)	25	65	950	2.8	5.3	PV-25A14F
	32	120	1750	4	7.5	PV-32A14F

#### Dimensions (mm)

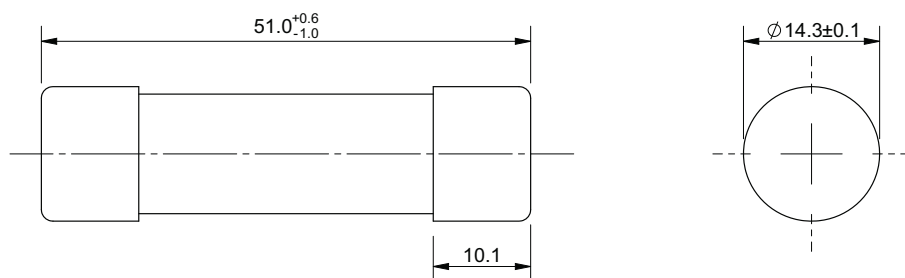

**PV-14F - 14 x 51 mm, 1000 and 1100 V d.c. (IEC/UL), 15 A to 32 A**

Time-current curve - 15 A to 32 A

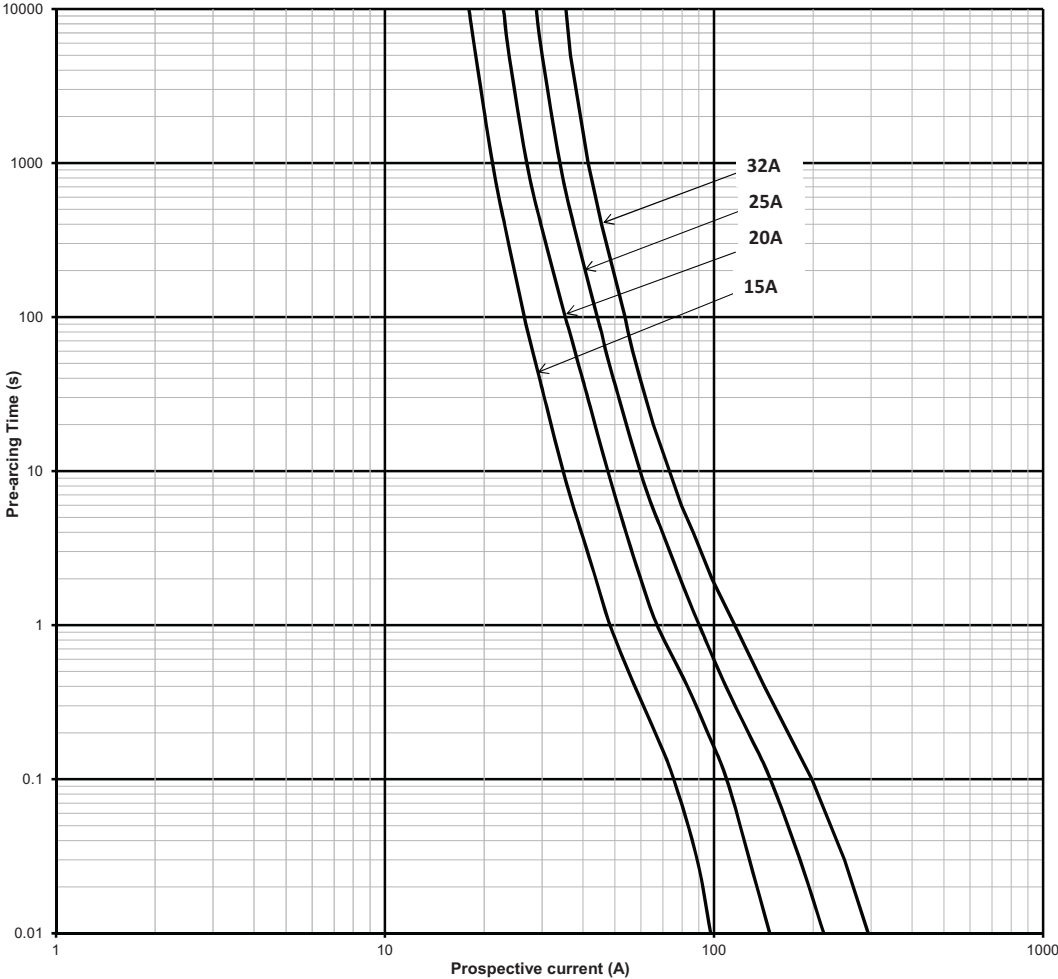

# Photovoltaic fuse links, fuse bases and holders

## CHPV14 - 14 x 51 mm, Modular fuse holders, 1500 V d.c., 50 A

### Specifications

#### Description

Compact DIN-Rail mounting fuse holders specifically designed for 14 x 51 mm photovoltaic fuse links.

#### Catalogue numbers

- CHPV141U 1-pole without indicator
- CHPV142 2-pole without indicator
- CHPV141IU 1-pole with indicator
- CHPV142IU 2-pole with indicator

#### Standards / Agency information

IEC 60269-1 and 2, UL Listed file number E348242



### Technical data

Rated voltage	Rated current	Agency markings	Terminal rating	Rated breaking withstand capacity	Compatible Bussmann series fuse links
1500 V d.c.	32 A	IEC 60269-1 and 2 UL Listed file number E348242	Cable size: 1.5-50 mm <sup>2</sup> Recommended torque setting: 3.5 Nm Maximum torque setting: 3.5Nm Mounting 35 mm DIN-Rail or 2 x M4 panel mounting screws	10 kA d.c.	PV-A14F

### Accessories

Catalogue numbers	Description	Unit packing
JV-L	Multi-pole connector kit. One kit will gang up to 4-poles together	12
CH14-CTP	IP20 Protection accessory, provides IP20 protection to terminals with 10mm <sup>2</sup> or less cable	12

### Dimensions (mm)

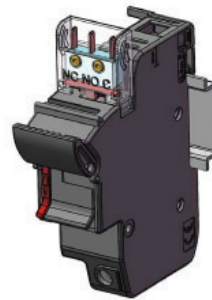
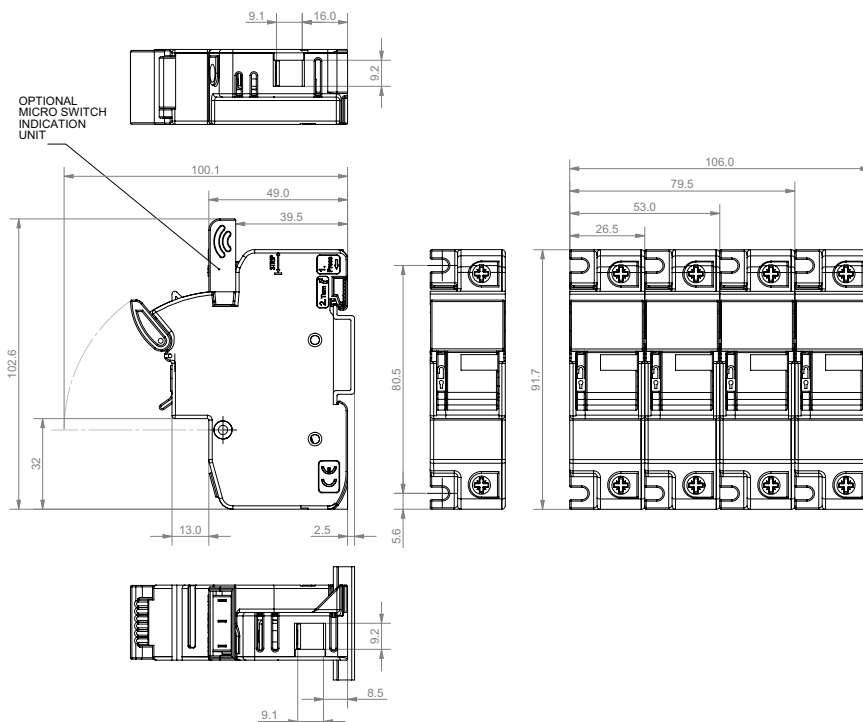

Data sheet: 10080

## PV-14L - 14 x 65 mm, 1300-1500 V d.c. (IEC and UL), 2.25 A to 32 A

### Specifications

#### Description

A range of fuse links in a 14 x 65 mm package specifically designed for the protection and isolation of photovoltaic strings. The fuse links are capable of interrupting low overrated currents associated with faulted PV (reverse rated current, multi-array fault).

#### Technical data

- Rated voltage:
  - 1500 V d.c. (IEC and UL, 2.25 A to 20 A)
  - 1300 V d.c. (IEC and UL, 25 A and 32 A)
- Rated current: 2.25 A to 32 A
- Breaking capacity: 10 kA
- Operating class: gPV and UL PV fuse links



#### Compatible fuse holder for PV-A14LF10F

CHPV15L85

#### Standards / Agency information

IEC 60269-6, UL Recognised 2579 (File number E335324), RoHS compliant, Pending: CCC.

#### Catalogue numbers

Rated voltage	Rated current (Amps)	I <sup>2</sup> t (A <sup>2</sup> Sec)		Watts loss (W)		Catalogue numbers		
		Pre-arcing	Total at rated voltage	0.8 I <sub>n</sub>	I <sub>n</sub>	Cylindrical	Cylindrical with tags	Cylindrical with 10mm fixings
1500 V d.c. (IEC/UL)	2.25	4	8	1.4	2.3	PV-2.25A14LF	N/A	PV-2.25A14LF10F
	2.5	5	10	1.5	2.5	PV-2.5A14LF	PV-2.5A14L-T	PV-2.5A14LF10F
	3	8	14	1.7	2.8	PV-3A14LF	PV-3A14L-T	PV-3A14LF10F
	3.5	12	23	1.8	3.0	N/A	N/A	PV-3.5A14LF10F
	4	18	34	2	3.3	PV-4A14LF	PV-4A14L-T	PV-4A14LF10F
	15	16	190	2.9	5.1	PV-15A14LF	PV-15A14L-T	PV-15A14LF10F
1300 V d.c. (IEC/UL)	20	34	400	3.8	6.9	PV-20A14LF	PV-20A14L-T	PV-20A14LF10F
	25	65	550	4.1	7.5	PV-25A14LF	PV-25A14L-T	PV-25A14LF10F
	32	105	900	5.7	10.4	PV-32A14LF	PV-32A14L-T	PV-32A14LF10F

# Photovoltaic fuse links, fuse bases and holders

## PV-14L - 14 x 65 mm, 1300-1500 V d.c. (IEC and UL), 2.25 A to 32 A

### Dimensions (mm) - PV-\*A14LF, Cylindrical

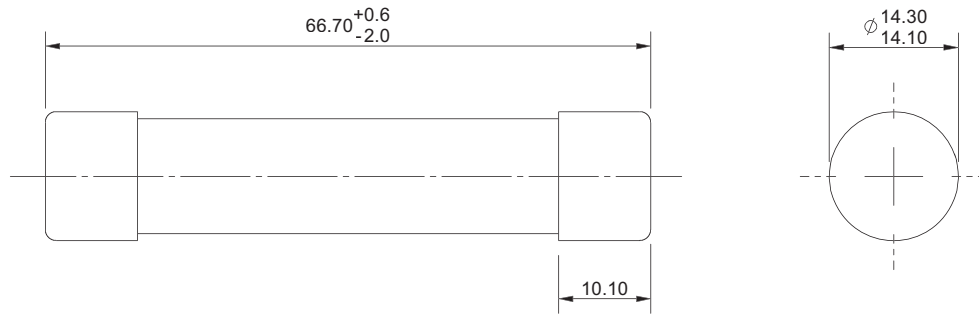

### Dimensions (mm) - PV-\*A14LF10F, Cylindrical with 10 mm Fixings

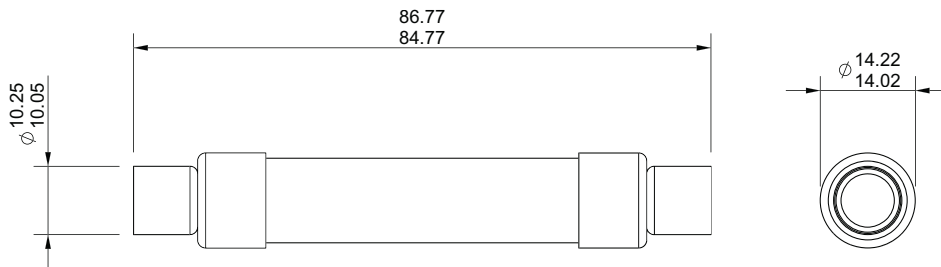

### Dimensions (mm) - PV-\*A14L-T, Cylindrical with tags

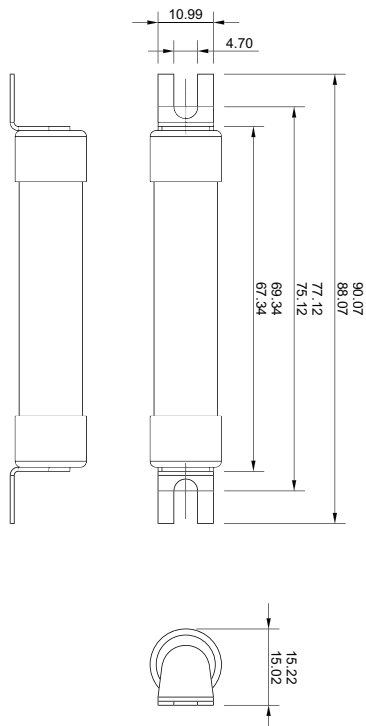

**PV-14L - 14 x 65 mm, 1300-1500 V d.c. (IEC and UL), 2.25 A to 32 A**

**Time-current curve - 2.25 A to 4 A**

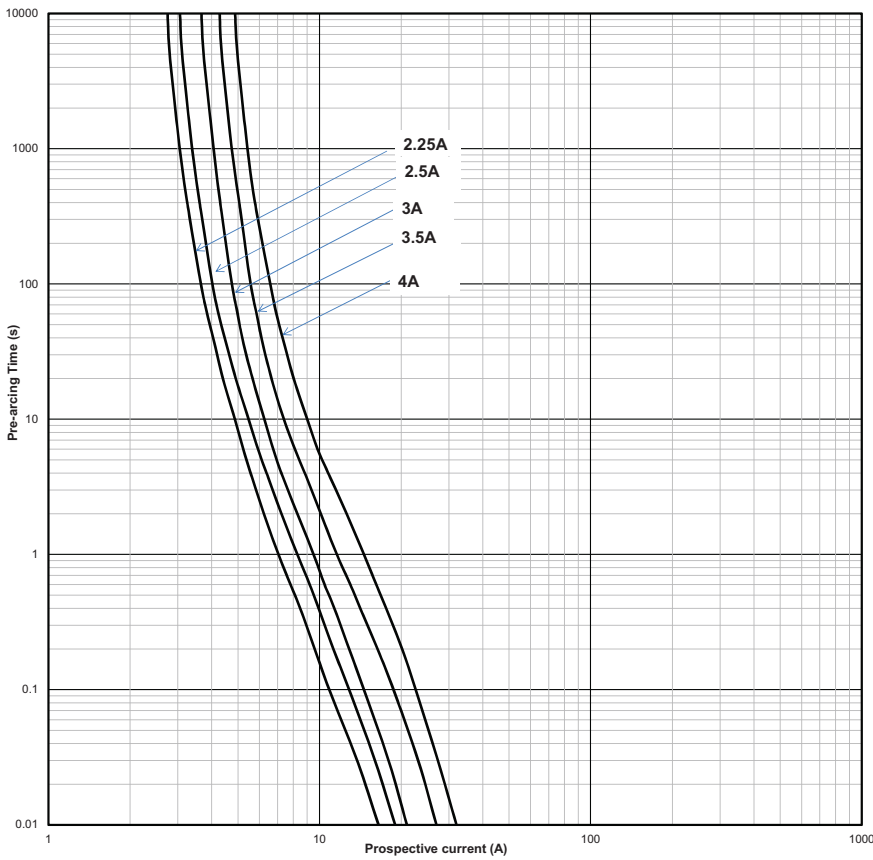

**Time-current curve - 3.5 A to 32 A**

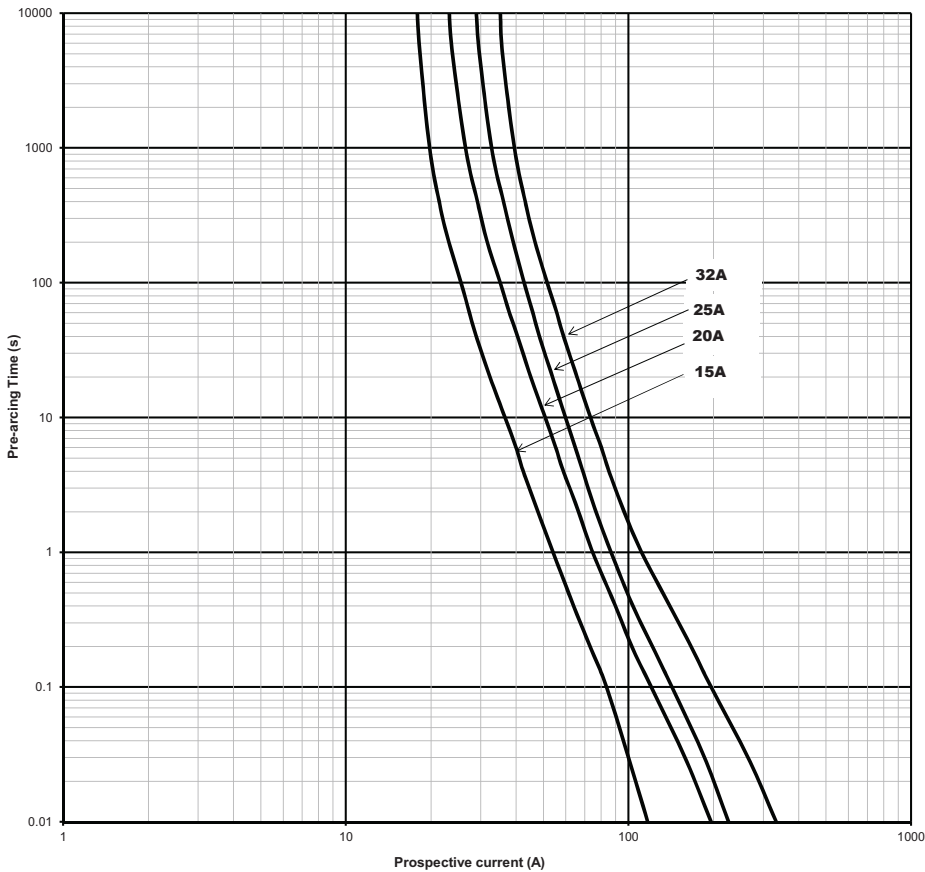

Data sheet: 720139, 5785579

# Photovoltaic fuse links, fuse bases and holders

## NH 170M - 800 V a.c. (IEC/UL), 32 A to 400 A

### Specifications

#### Description

Eaton's Bussmann series NH size 800 V a.c. fuse links are specifically designed to meet the needs of branch circuit and transformer protection in photovoltaic inverter systems. The fuse links are capable of interrupting low overcurrents associated with faulted PV systems (reverse current, multi-array fault).

#### Technical data

- Rated voltage: 800 V a.c.
- Rated current: 32 A to 400 A
- Breaking capacity: 65 kA
- Operating class: gR

#### Compatible fuse base

SD-D-PV see details page 352

#### Microswitches, for use with bladed version

- 170H0236
- 170H0238

#### Standards / Agency information

UL 248-13 (file number E125085), IEC 60269-4 (see details below)

#### Catalogue numbers

Fuse link body size	Rated voltage	Rated current (Amps)	I <sup>t</sup> (A <sup>2</sup> Sec)		Watts loss (W)	Catalogue numbers	
			Pre-arcing	Total at 800 V a.c.		Bladed with lugs	Blade with bolt holes no lugs
NH1	800 V a.c.	32	80	2000	8	170M7350	
		40	185	3000	9	170M7351	
		50	400	6000	11	170M7352	
		63	470	7000	12	170M7353*	170M7353-B*
		80	640	9000	15	170M7354	170M7354-B
		100	1300	17000	16	170M7355	170M7355-B
		125	2600	34000	17	170M7356*	170M7356-B*
		160	5200	68000	27	170M7357*	170M7357-B*
		200	10200	140000	25	170M7358*	170M7358-B*
NH2	800 V a.c.	160	4600	36800	28	170M7397	170M7397-B
		200	9500	76000	32	170M7398	170M7398-B
		250	17000	136000	38	170M7399	170M7399-B
		315	32000	230000	44	170M7400*	170M7400-B*
NH3	800 V a.c.	355	44500	320000	46	170M7401*	
		400	67500	480000	50	170M7402*	
		355	38000	270000	48		170M7401-B*
		400	61000	430000	50		170M7402-B*

\*UL 248-13 and IEC 60269-4





**NH 170M - 800 V a.c. (IEC/UL), 32 A to 400 A**

Dimensions (mm) - NH1, bladed with lugs

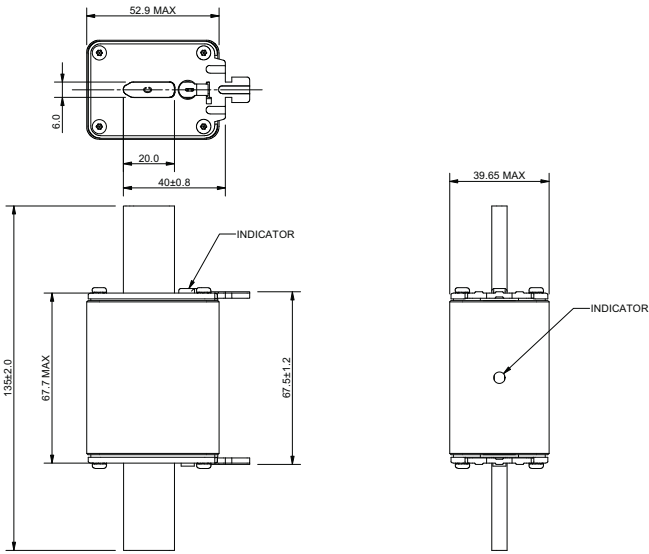

Dimensions (mm) - NH2, bladed with lugs

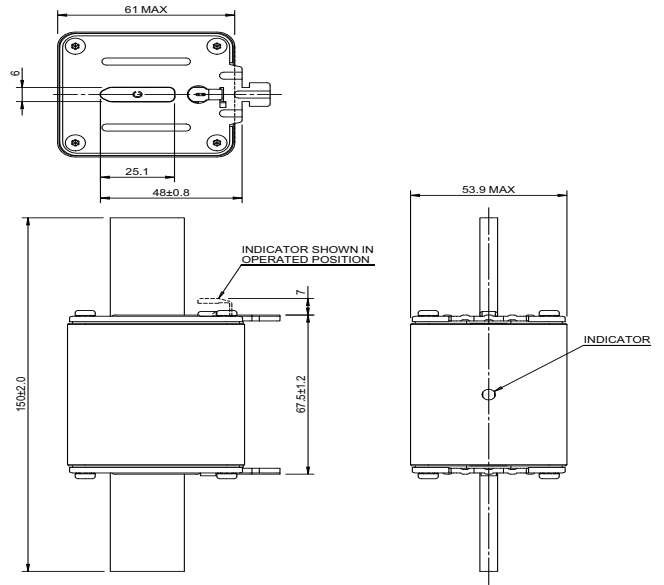

Dimensions (mm) - NH3, bladed with lugs

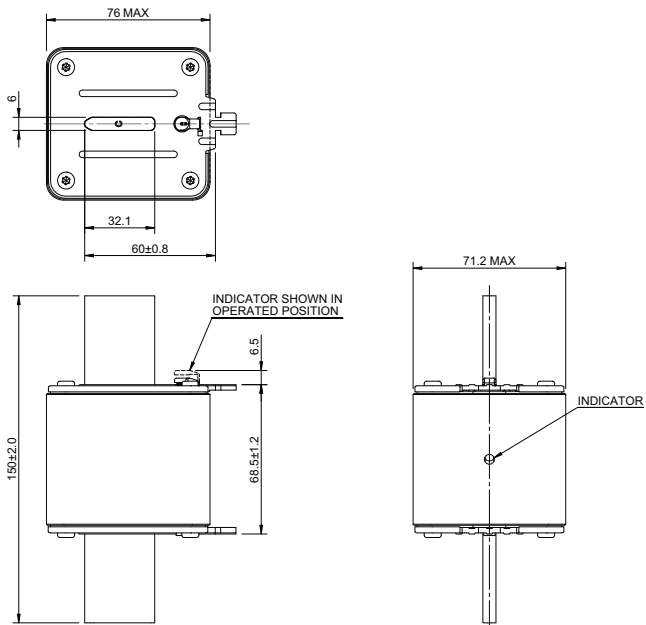

# Photovoltaic fuse links, fuse bases and holders

## NH 170M - 800 V a.c. (IEC/UL), 32 A to 400 A

Dimensions (mm) - NH1, bolt holes no lugs

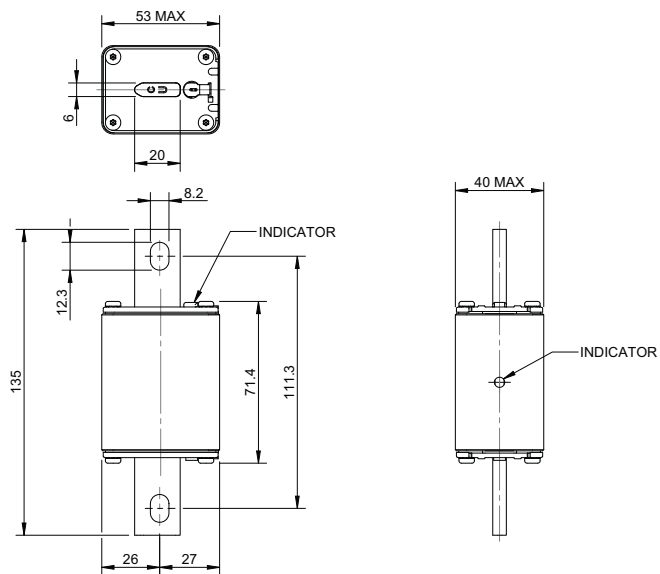

Dimensions (mm) - NH2, bolt holes no lugs

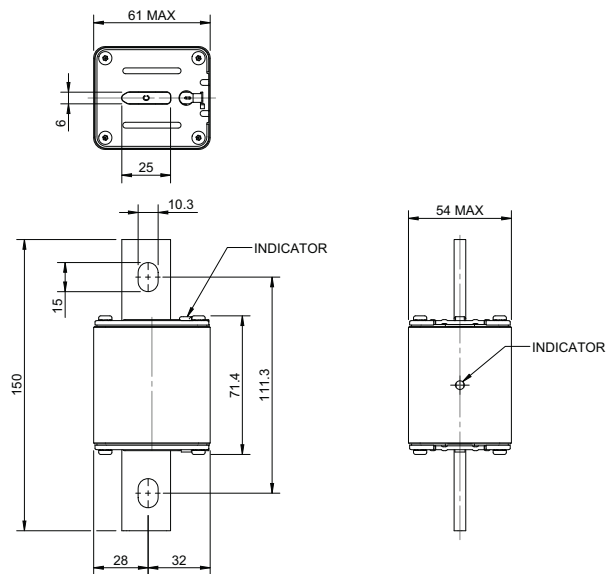

Dimensions (mm) - NH3, bolt holes no lugs

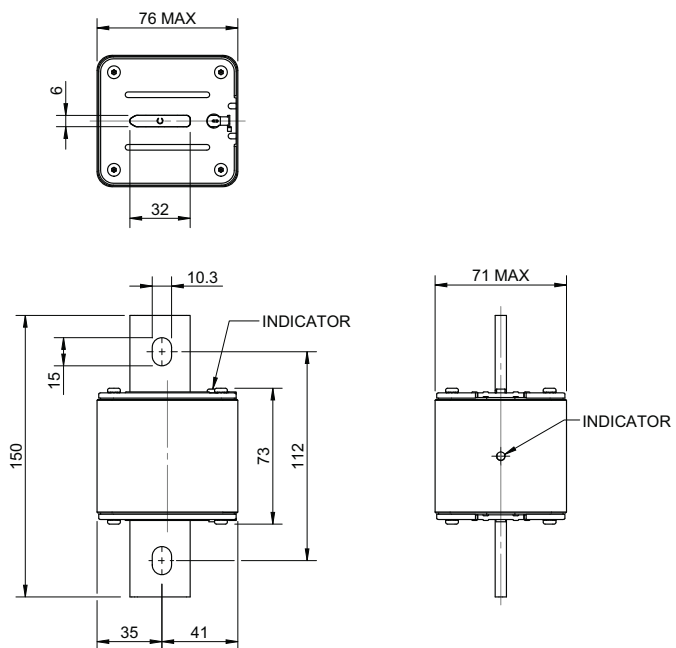

**NH 170M - 800 V a.c. (IEC/UL), 32 A to 400 A**

**Time-current curve - Size 1, 32 A to 200 A**

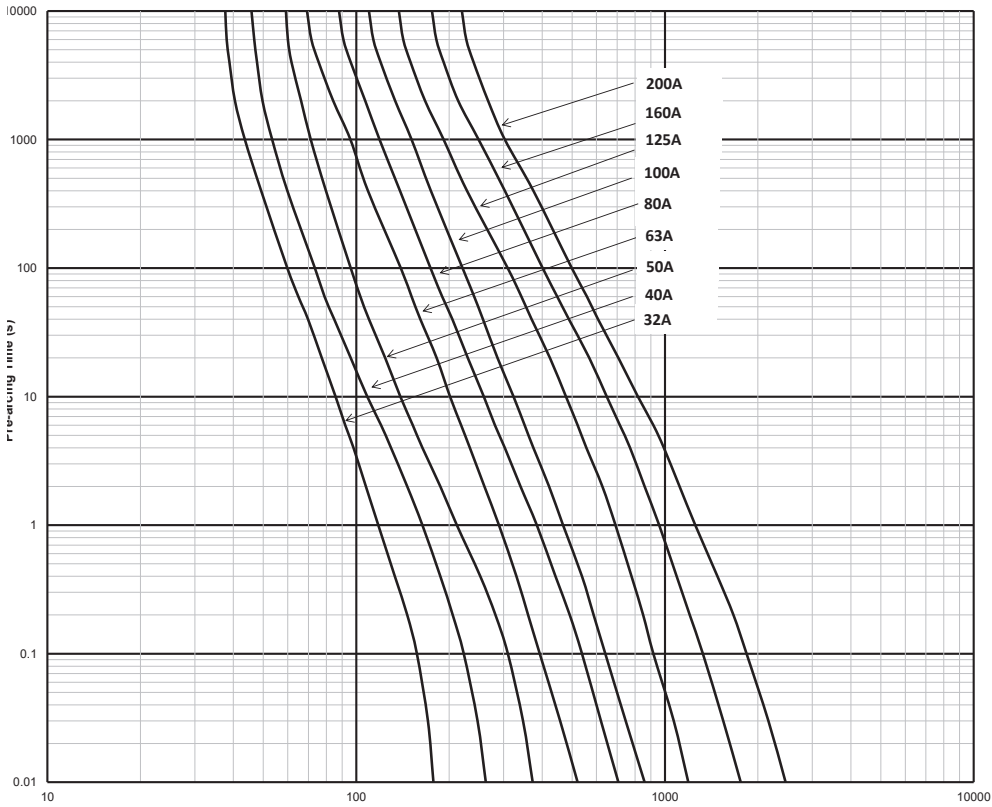

**Time-current curve - Size 2, 160 A to 250 A**

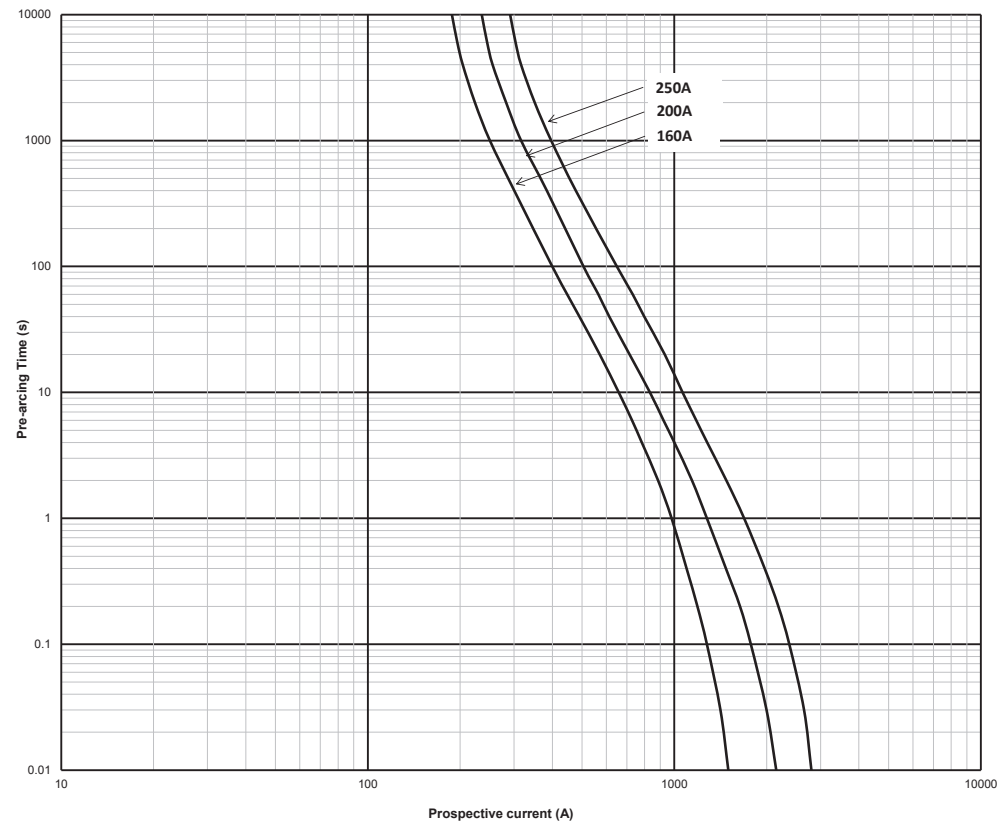

# Photovoltaic fuse links, fuse bases and holders

## NH 170M - 800 V a.c. (IEC/UL), 32 A to 400 A

### Time-current curve - Size 3, 315 A to 400 A

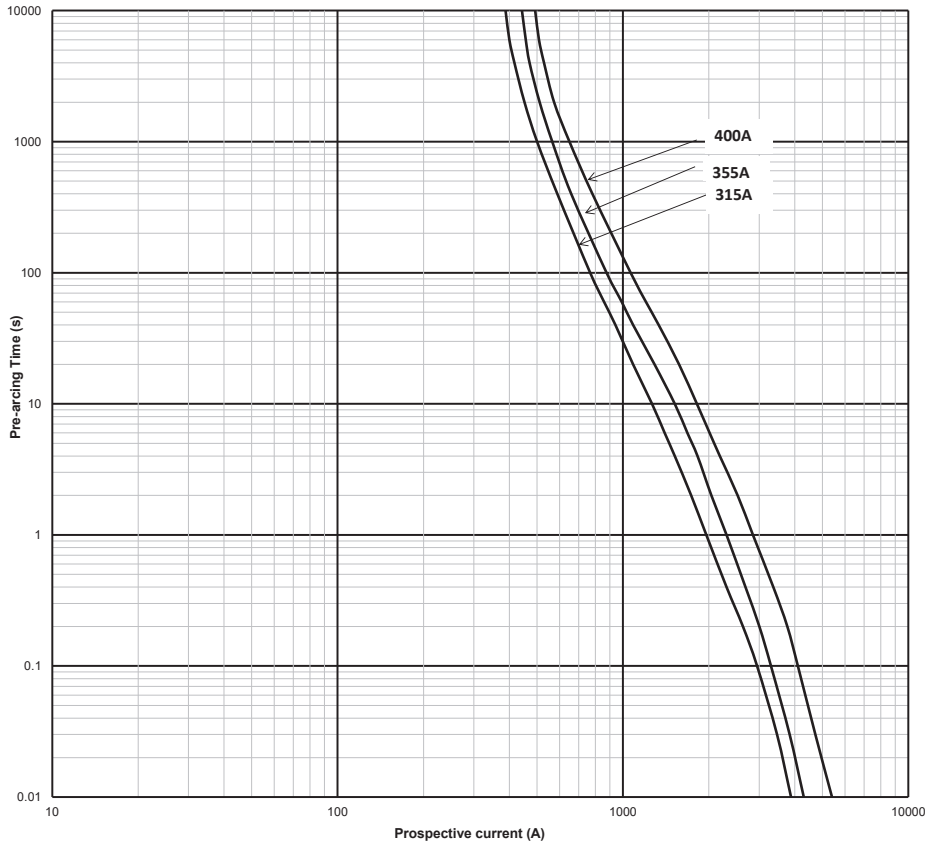

### Temperature derating curve

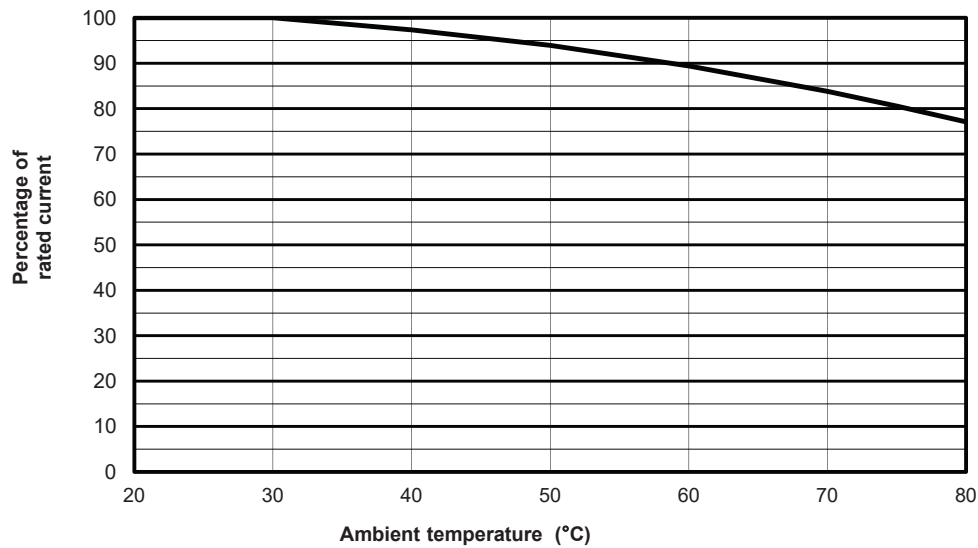

**NH 170M - 800 V a.c. (IEC/UL), 32 A to 400 A**

**Cut-off curve - Size 1, 32 A to 200 A**

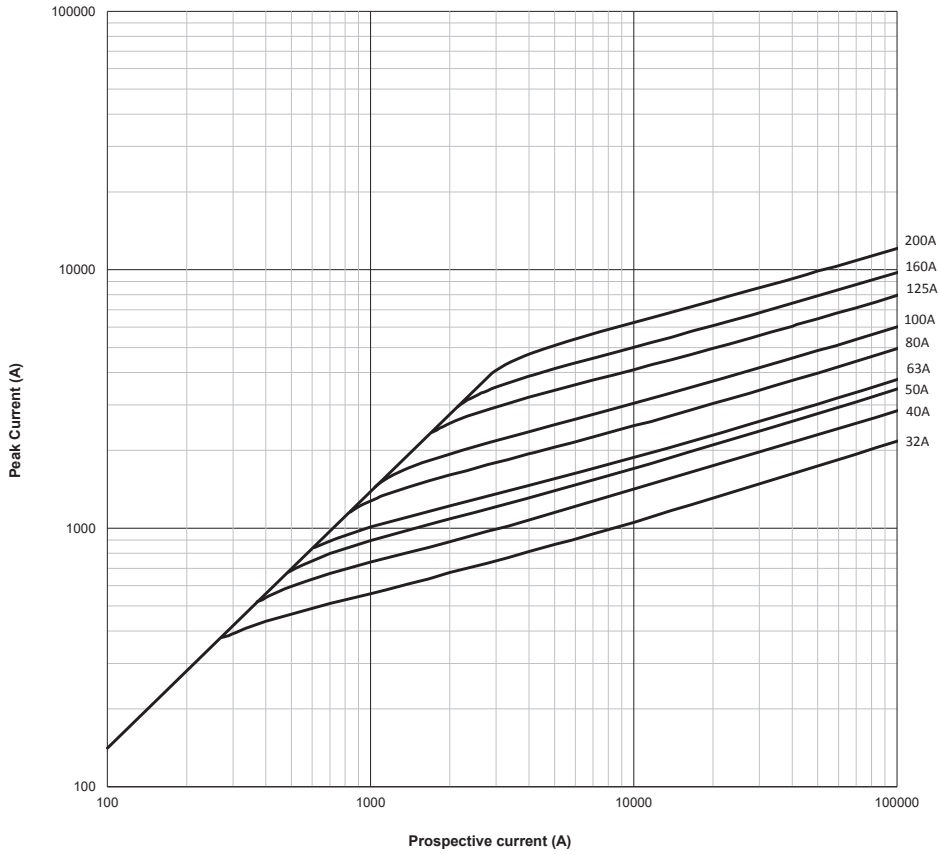

**Cut-off peak current curve - Size 2, 160 A to 250 A**

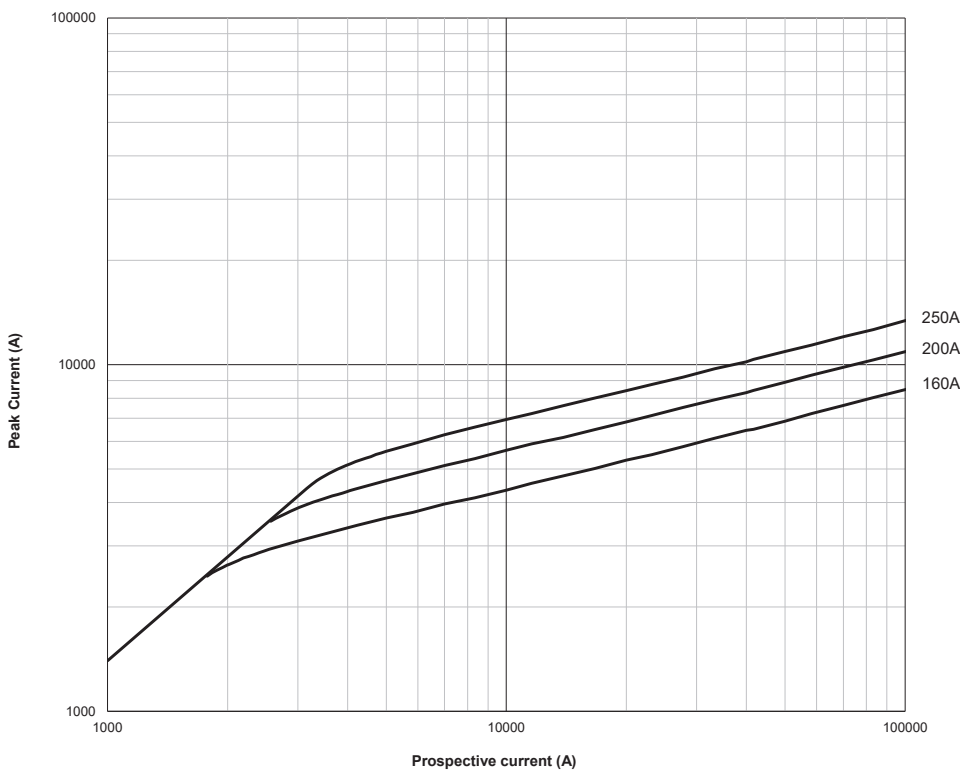

PEAK CURRENT SHOWN FOR SYMMETRICAL FAULTS ONLY

Data sheet: 1U/84

# Photovoltaic fuse links, fuse bases and holders

## NH 170M - 800 V a.c. (IEC/UL), 32 A to 400 A

### Cut-off peak current curve - Size 3, 315 A to 400 A

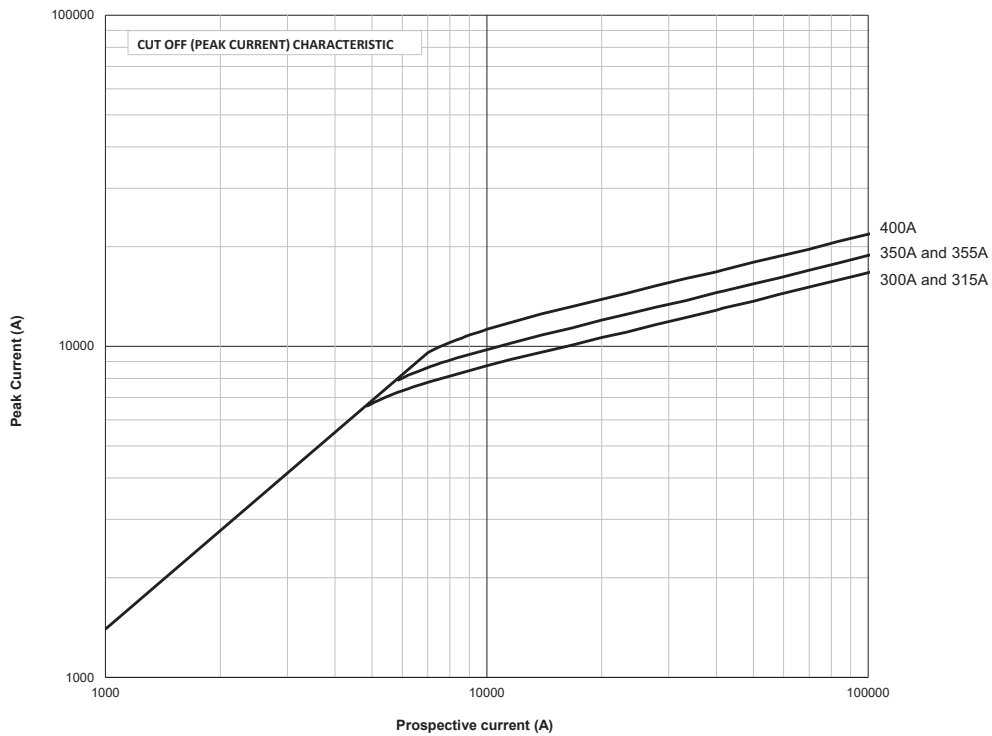

PEAK CURRENT SHOWN FOR SYMMETRICAL FAULTS ONLY

## NH PV-ANH - 1000 V d.c. (IEC/UL), 32 A to 400 A

### Specifications

#### Description

A range of NH size bladed fuse links specifically designed for protecting and isolating photovoltaic array combiners and disconnects. These fuse links are capable of interrupting low overrated currents associated with faulted PV systems (reverse rated current, multi-array fault).

#### Technical data

- Rated voltage: 1000 V d.c. (IEC and UL)
- Rated current: 32 A to 400 A
- Breaking capacity: 50 kA
- Operating class: gPV and UL PV fuse links

#### Compatible fuse base

SD-D-PV see page 352

#### Standards / Agency information

IEC 60269-6, UL Recognised file 2579 E335324 for size 1 only, RoHS compliant



#### Catalogue numbers

Fuse link body size	Rated voltage	Rated current (Amps)	I <sup>2</sup> t (A <sup>2</sup> Sec)		Watts loss (W)		Catalogue numbers				
			Pre-arcing	Total at 1000 V d.c.	0.8 I <sub>n</sub>	I <sub>n</sub>	Blade without bolt holes	Blade with bolt holes	Blade with bolt holes and lugs		
NH1	1000 V d.c. (IEC/UL)	32	80	720	4	8	PV-32ANH1	PV-32ANH1-B			
		40	185	1670	5	9	PV-40ANH1	PV-40ANH1-B			
		50	400	3600	6	11	PV-50ANH1	PV-50ANH1-B			
		63	470	4300	6	12	PV-63ANH1				
		80	640	5760	8	15	PV-80ANH1				
		100	1300	11700	8	16	PV-100ANH1				
		110	2100	18900	9	18.5	PV-110ANH1				
		125	2600	23400	9	17	PV-125ANH1				
		160	5200	46800	14	27	PV-160ANH1				
		175	8300	74700	15	29	PV-175ANH1				
NH2	1000 V d.c. (IEC/UL)	200	10200	82000	13	25	PV-200ANH1				
		160	4600	37000	14	28	PV-160ANH2				
		200	9500	76000	16	32	PV-200ANH2				
NH3	1000 V d.c. (IEC/UL)	250	17000	136000	19	38	PV-250ANH2				
		300	32000	260000	24	40	PV-300ANH3				
		315	32000	260000	26	44	PV-315ANH3				
		350	44500	370000	27	45	PV-350ANH3				
NH1	1000 V d.c. (IEC/UL)	355	44500	370000	28	46	PV-355ANH3				
		400	67500	550000	30	50	PV-400ANH3				
		63	470	4300	6	12		PV-63ANH1-B	PV-63ANH1-BL		
		80	640	5760	8	15		PV-80ANH1-B	PV-80ANH1-BL		
		100	1300	11700	8	16		PV-100ANH1-B	PV-100ANH1-BL		
		125	2600	23400	9	17		PV-125ANH1-B	PV-125ANH1-BL		
		160	5200	46800	14	27		PV-160ANH1-B	PV-160ANH1-BL		
		200	10200	82000	13	25		PV-200ANH1-B	PV-200ANH1-BL		
		NH2	1000 V d.c. (IEC/UL)	160	4600	37000	14	28		PV-160ANH2-B	PV-160ANH2-BL
				200	9500	76000	16	32		PV-200ANH2-B	PV-200ANH2-BL
250	17000			136000	19	38		PV-250ANH2-B	PV-250ANH2-BL		
NH3	1000 V d.c. (IEC/UL)	315	32000	260000	26	44		PV-315ANH3-B	PV-315ANH3-BL		
		355	38000	310000	29	48		PV-355ANH3-B	PV-355ANH3-BL		
		400	61000	490000	32	50		PV-400ANH3-B	PV-400ANH3-BL		

Data sheet: 720133

# Photovoltaic fuse links, fuse bases and holders

## NH PV-ANH - 1000 V d.c. (IEC/UL), 32 A to 400 A

### Dimensions (mm) - NH1, blade without bolt holes

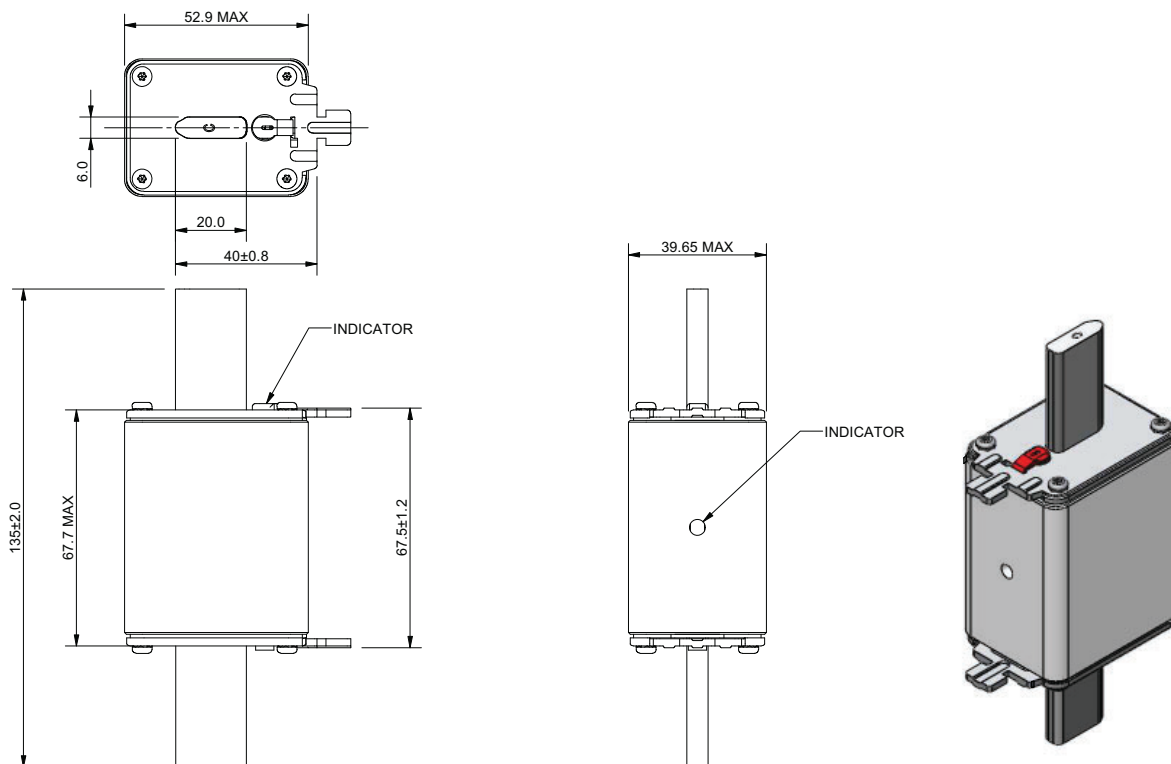

### Dimensions (mm) - NH2, blade without bolt holes

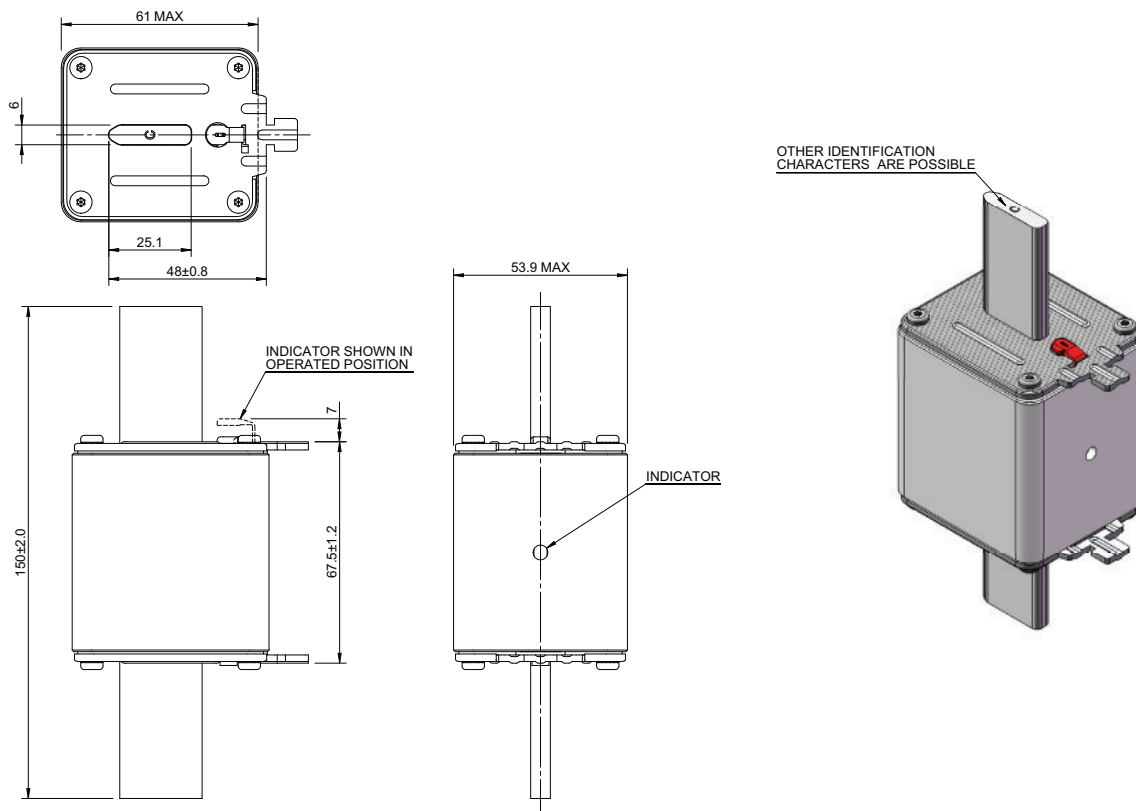



**NH PV-ANH - 1000 V d.c. (IEC/UL), 32 A to 400 A**

**Dimensions (mm) - NH3, blade without bolt holes**

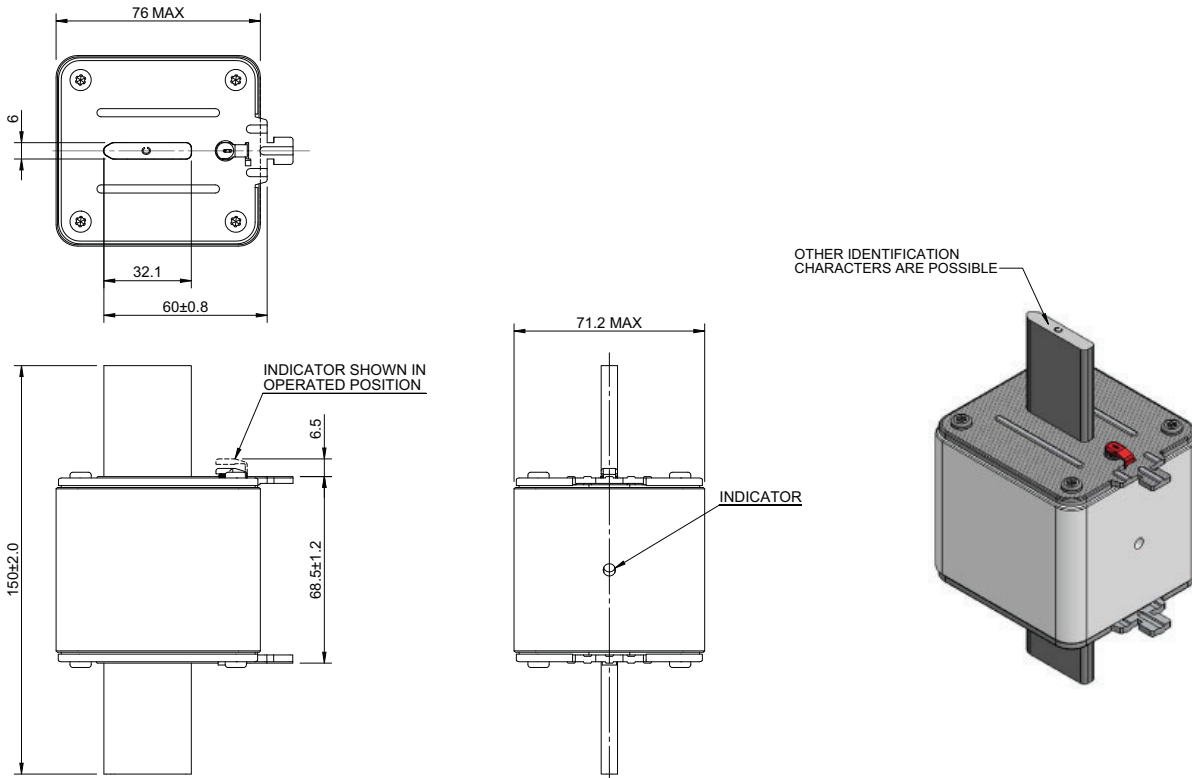

**Dimensions (mm) - NH1, blade with bolt holes**

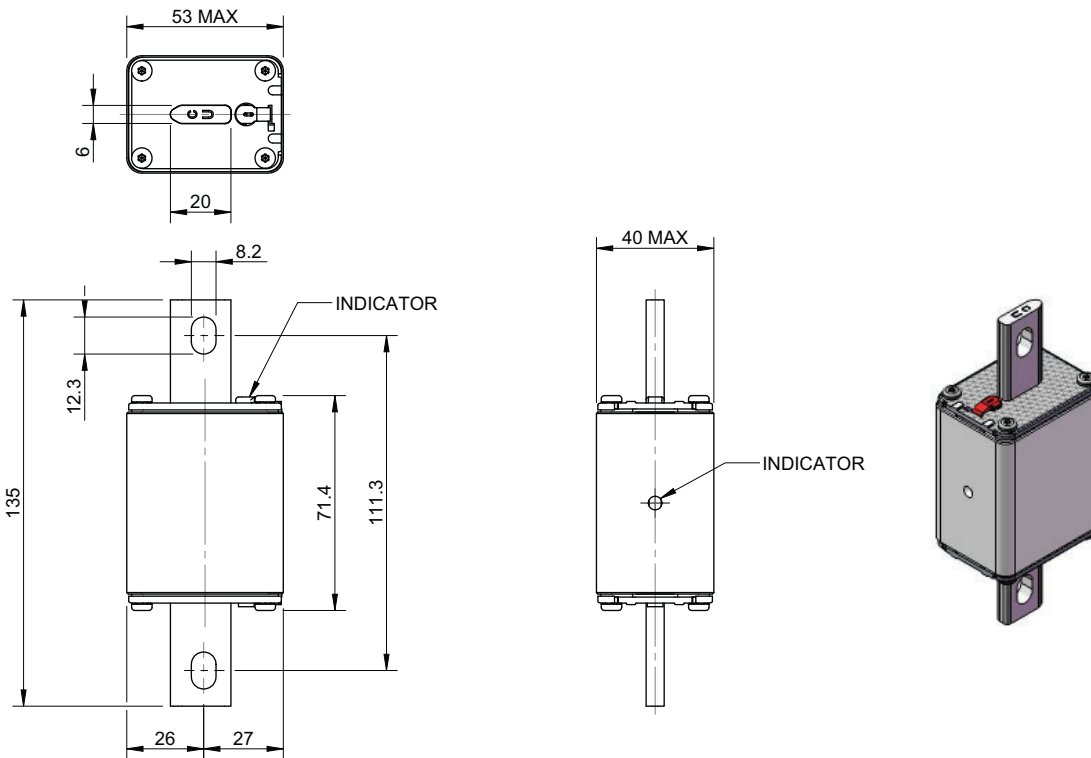

# Photovoltaic fuse links, fuse bases and holders

## NH PV-ANH - 1000 V d.c. (IEC/UL), 32 A to 400 A

### Dimensions (mm) - NH2, blade with bolt holes

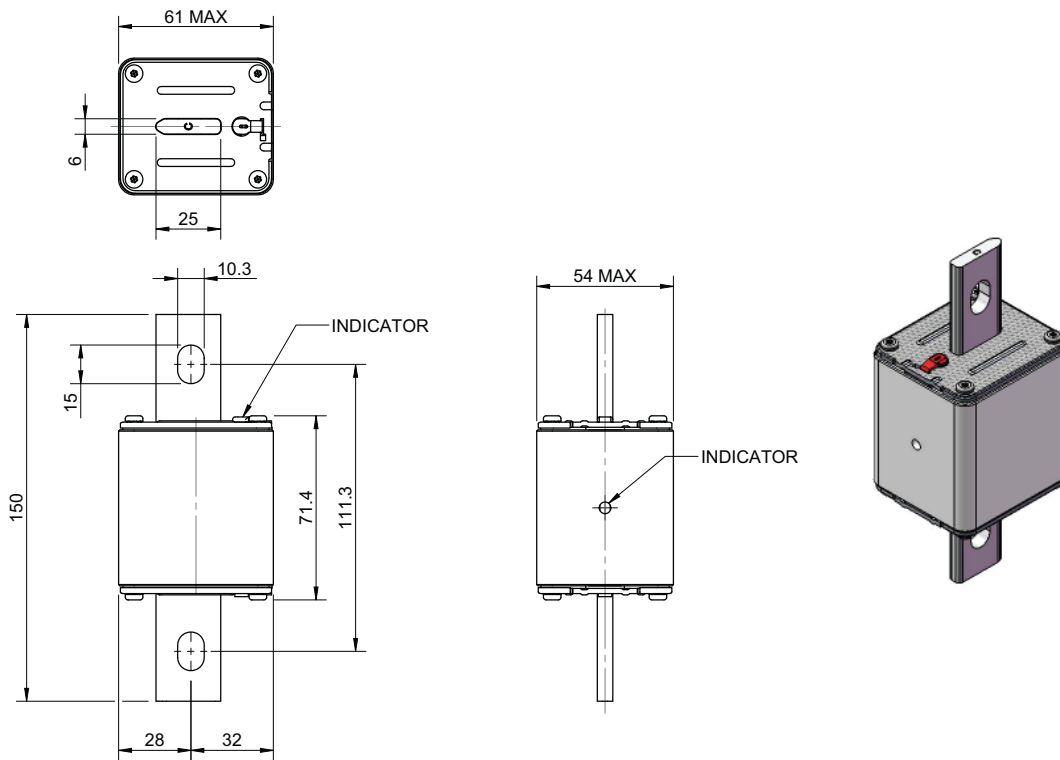

### Dimensions (mm) - NH3, blade with bolt holes

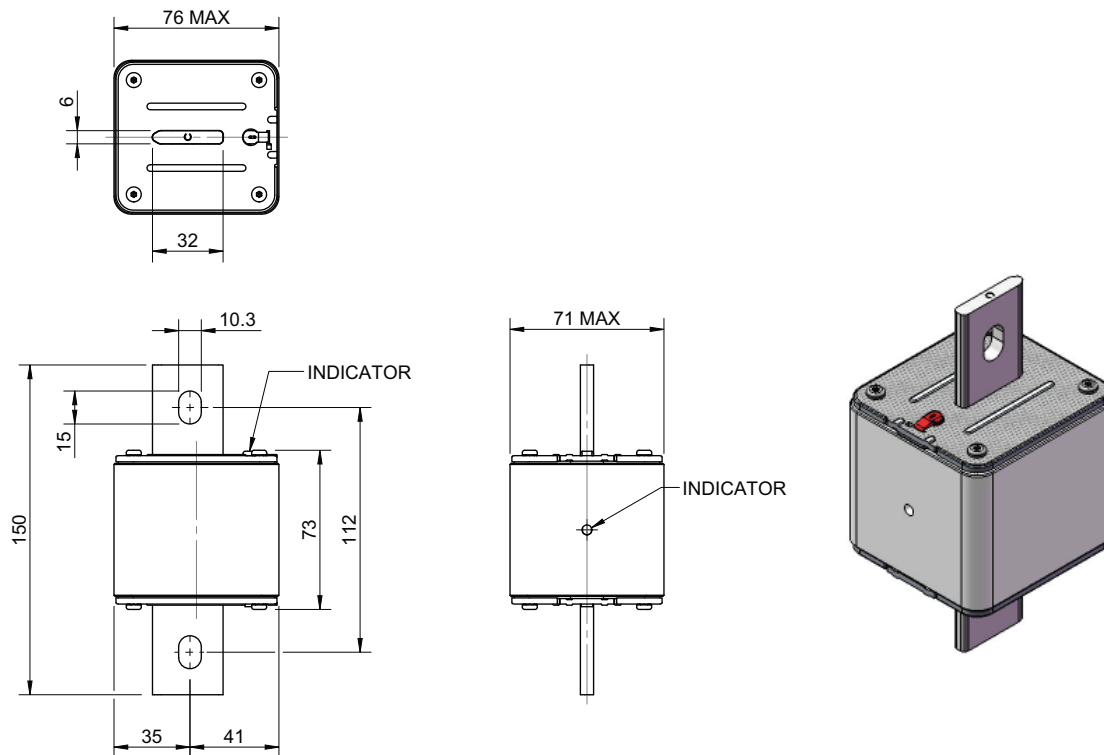

**NH PV-ANH - 1000 V d.c. (IEC/UL), 32 A to 400 A**

**Dimensions (mm) - NH1, blade with bolt holes and lugs**

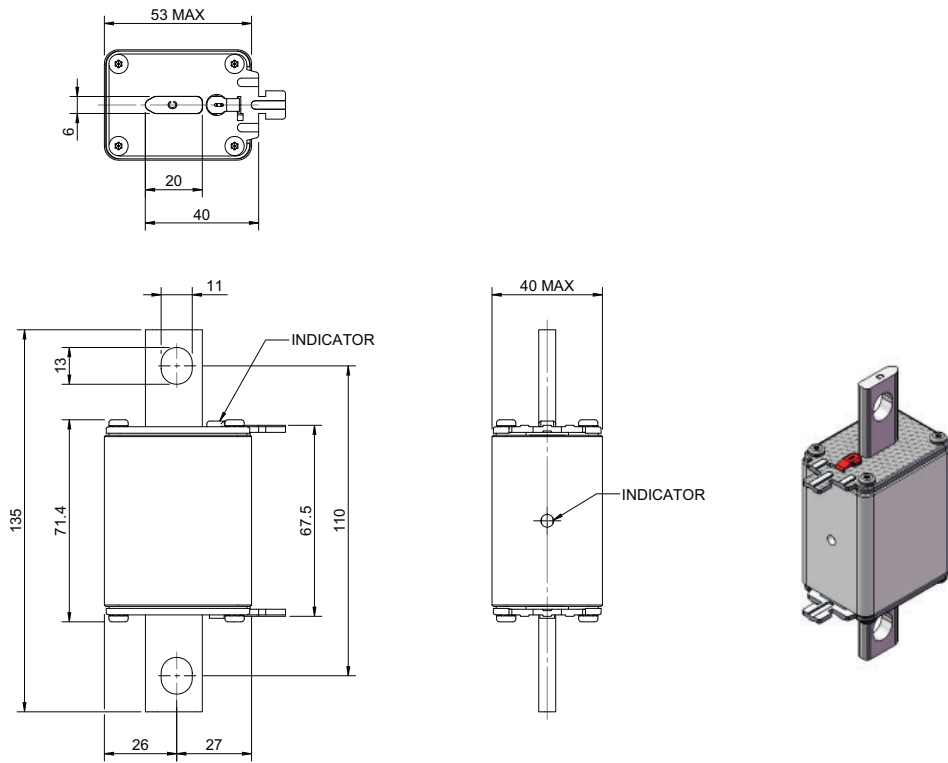

**Dimensions (mm) - NH2, blade with bolt holes and lugs**

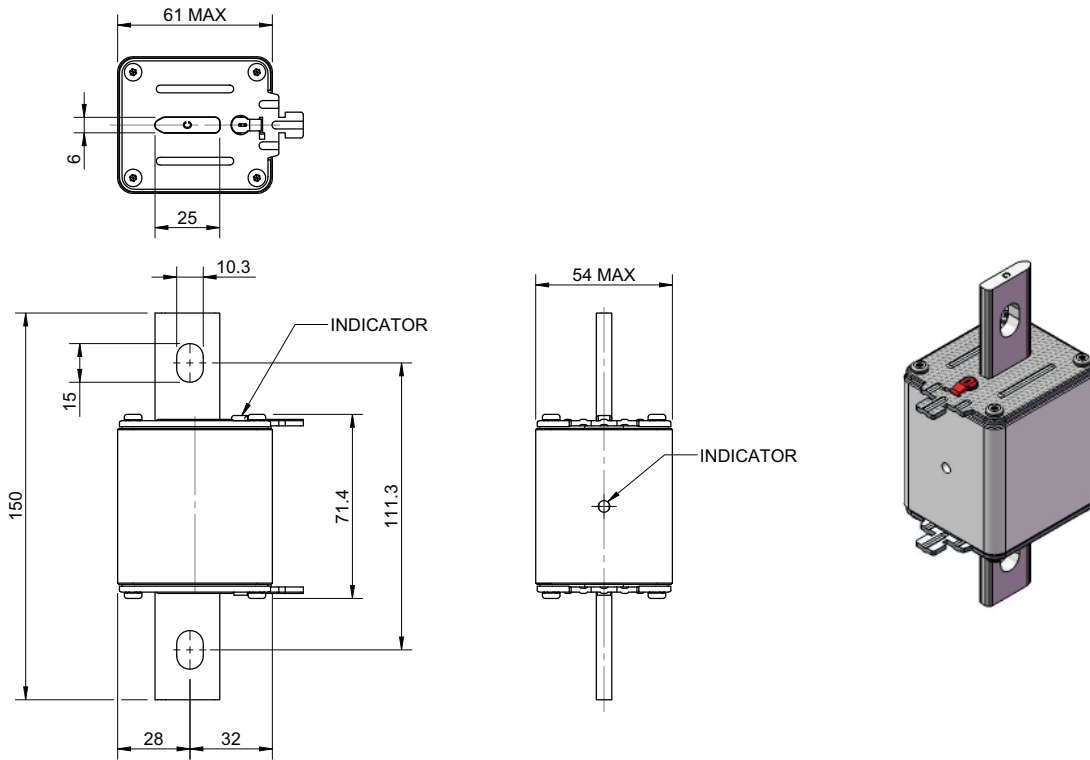

# Photovoltaic fuse links, fuse bases and holders

## NH PV-ANH - 1000 V d.c. (IEC/UL), 32 A to 400 A

Dimensions (mm) - NH3, blade with bolt holes and lugs

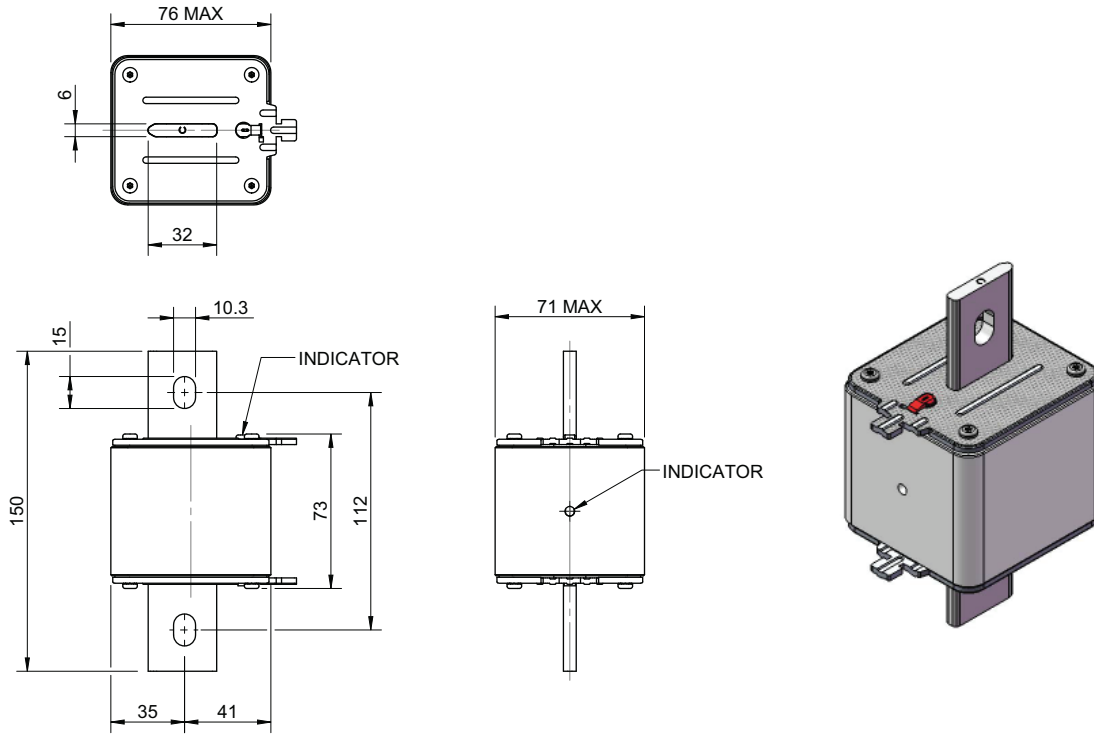

### Time-current curve - Size 1, 32 A to 200 A

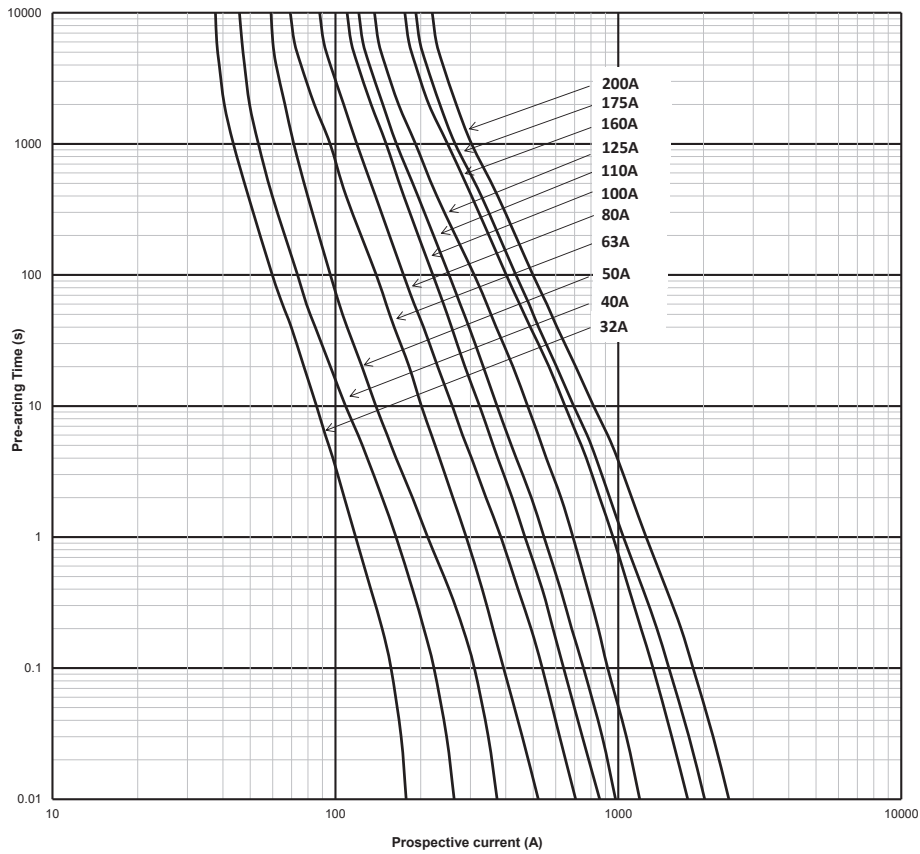

**NH PV-ANH - 1000 V d.c. (IEC/UL), 32 A to 400 A**

**Time-current curve - Size 2, 160 A to 250 A**

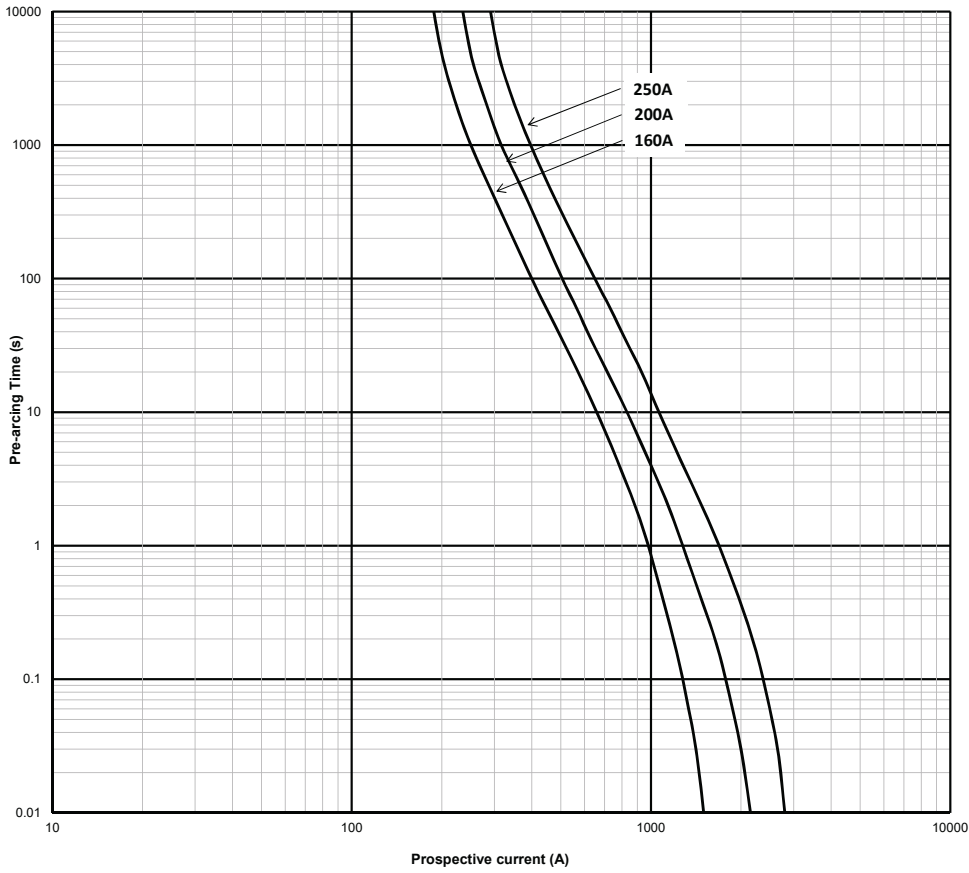

**Time-current curve - Size 3, 300 A to 400 A**

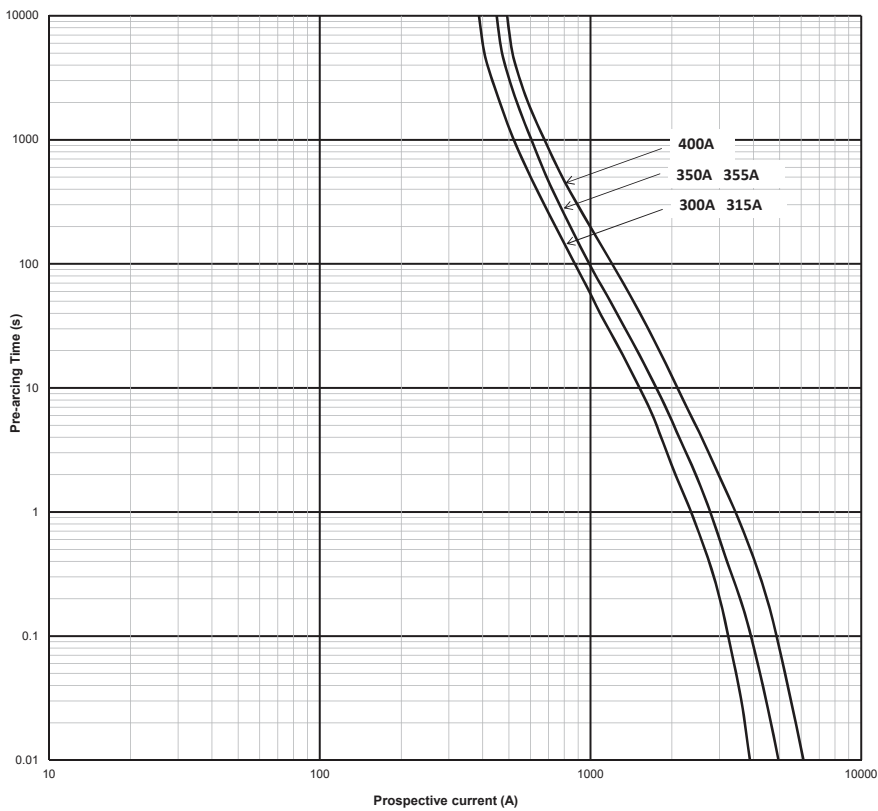

# Photovoltaic fuse links, fuse bases and holders

## NH PV-ANH - 1000 V d.c. (IEC/UL), 32 A to 400 A

Temperature derating curve - Sizes 1 to 3

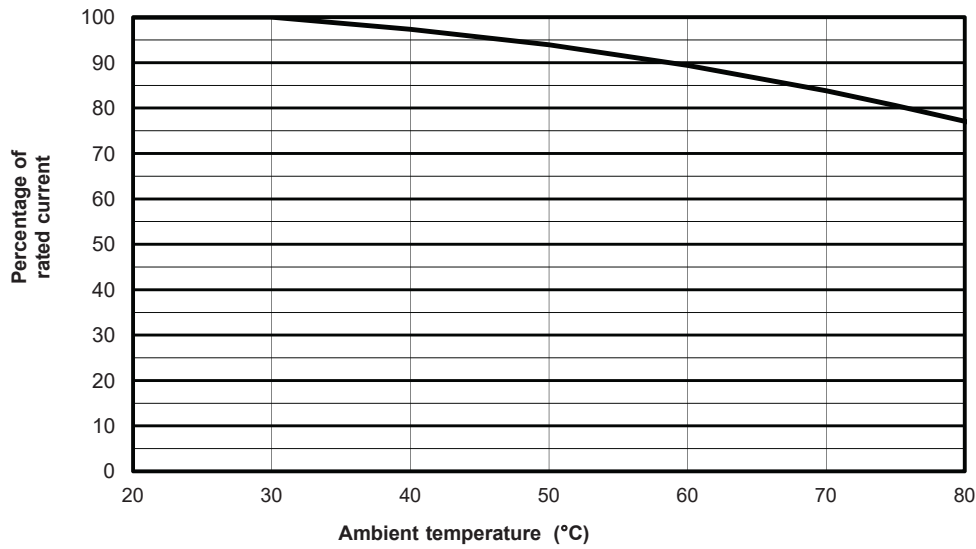

Cut-off curve - Size 1, 32 A to 200 A

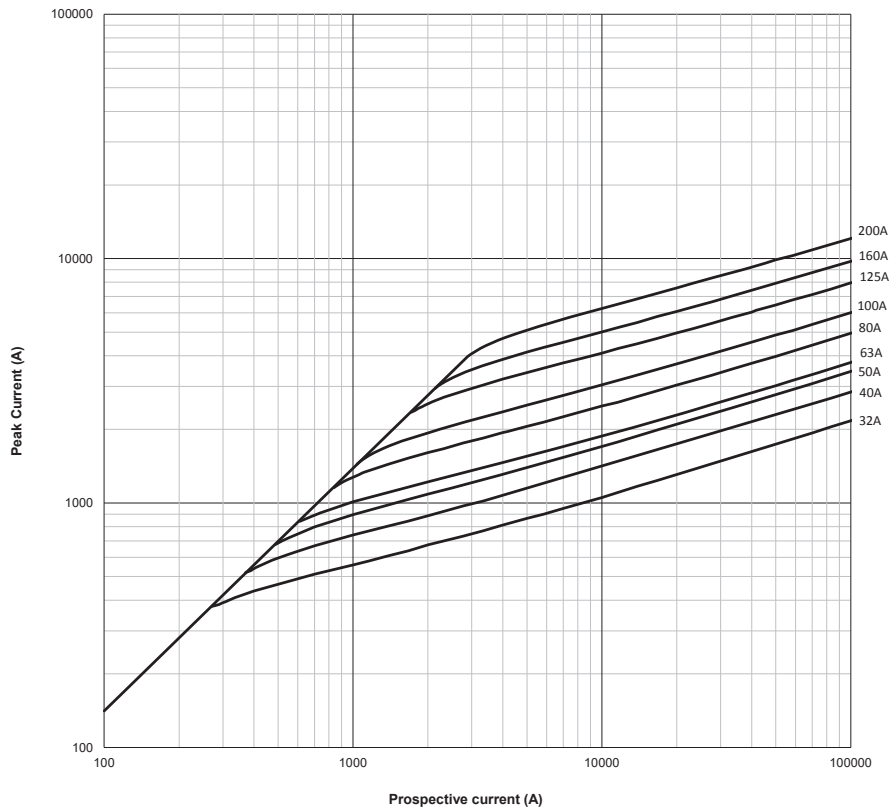

**NH PV-ANH - 1000 V d.c. (IEC/UL), 32 A to 400 A**

**Cut-off curve - Size 2, 160 A to 250 A**

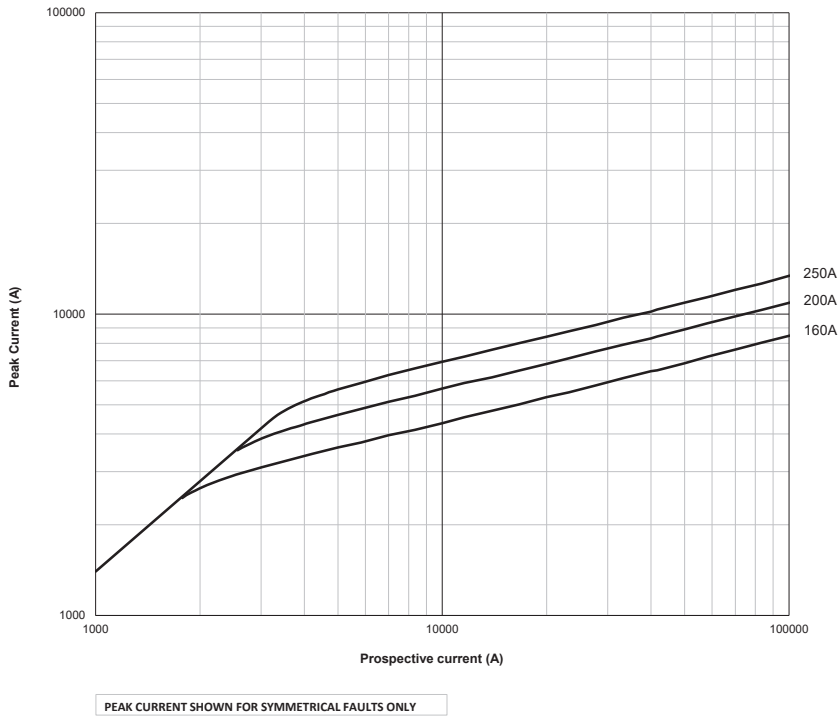

**Cut-off curve - Size 3, 300 A to 400 A**

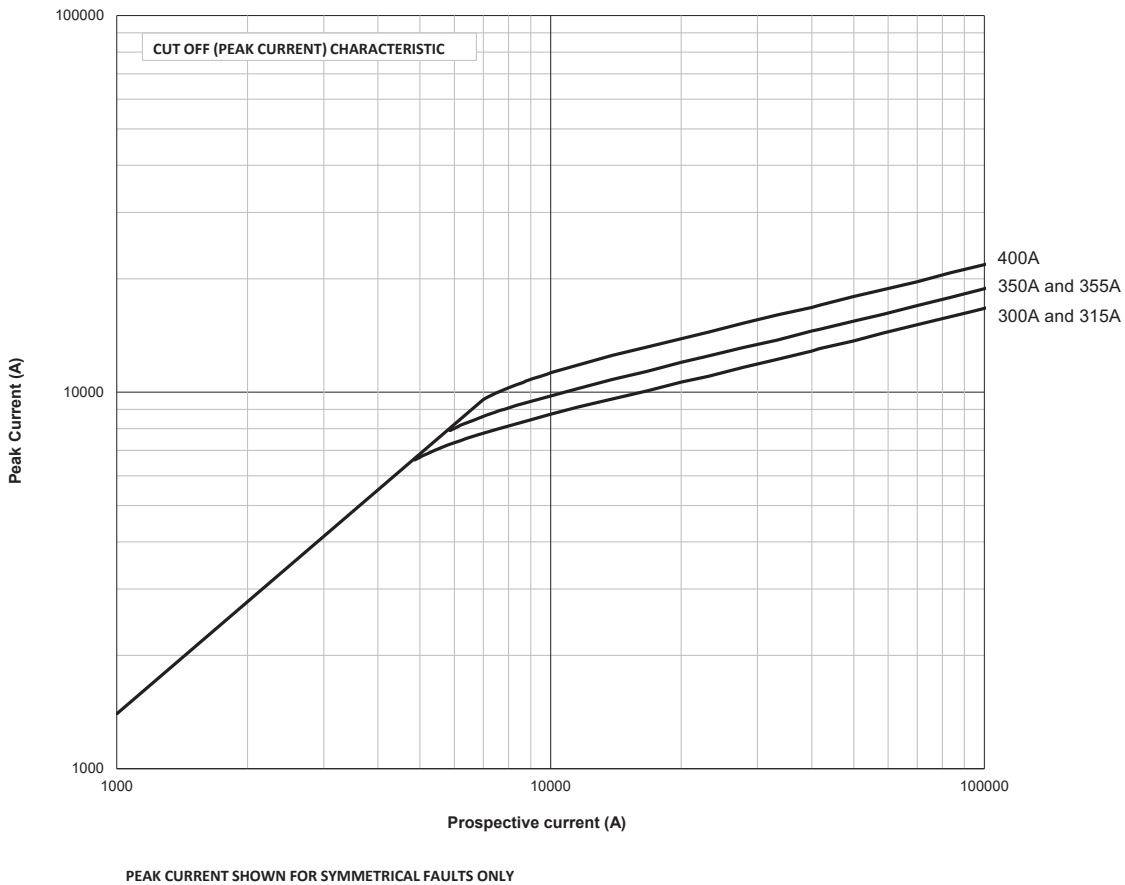

# Photovoltaic fuse links, fuse bases and holders

## SD-D-PV - NH fuse bases, 1500 V d.c. (IEC), 1000 V d.c. (UL/CSA) 250 A to 630 A, sizes 1 to 3

### Specifications

#### Description

Sizes 1 to 3 NH Fuse bases specifically designed for use with Bussmann series range of NH PV (Photovoltaic) fuse links.

#### Technical data

- Rated voltage:
  - 1500 V d.c. (IEC)
  - 1000 V d.c. (UL/CSA)
- Rated current:
  - 250 A (SD1)
  - 400 A (SD2)
  - 630 A (SD3)
- Fuse base sizes: 1 to 3
- Withstand: 50 kA
- Power acceptance
  - SD1: 32 W
  - SD2: 45 W
  - SD3: 60 W



#### Standards / Agency information

IEC 60269-1, UL Listed - UL File #E348242, CSA file #47235

#### Accessories:

- Microswitches - 170H0236, 170H0238 and BVL50
- IP20 Finger-Safe Protection Kit - TD1-IP20, TD2-IP20, TD3-IP20
- Fuse extraction handle
- Shroud kits

#### Dimensions (mm) - 1-pole with phase barriers

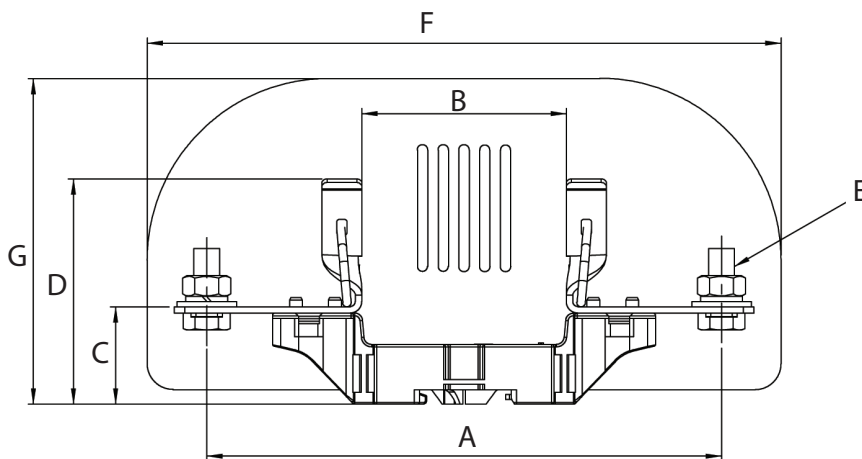

Catalogue numbers	Poles/Type	A	B	C	D	E	F	G
SD1-D-PV	1-pole	175	79	37	78	M10x25	245	125.5
SD2-D-PV	1 pole	199	79	37.5	86	M10x25	245	125.5
SD3-D-PV	1-pole	209	82	37.5	88	M12x30	260	137.5



**SD-D-PV - NH fuse bases, 1500 V d.c. (IEC), 1000 V d.c. (UL/CSA) 250 A to 630 A, sizes 1 to 3**

Dimensions (mm) - 1-pole without phase barriers

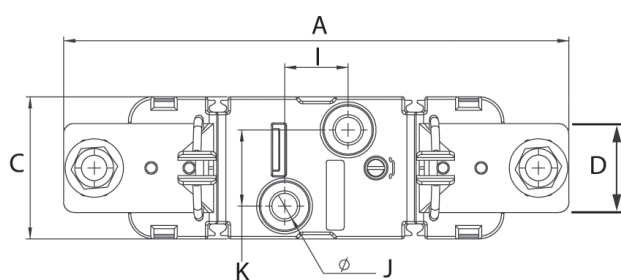
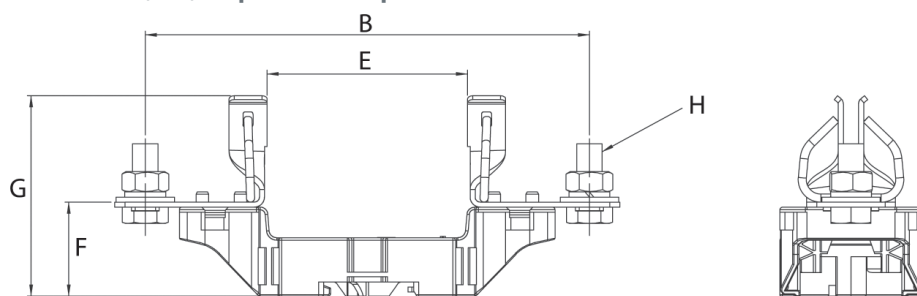

Catalogue numbers	Poles	A	B	C	D	E	F	G	H	I	J	K
SD1-D-PV	1-pole	199	175	56	35	79	37	78	M10x25	25	10	30
SD2-D-PV	1 pole	224	199	56	35	79	37.5	86	M10x25	25	10	30
SD3-D-PV	1-pole	239	209	56	36	82	37.5	88	M12x30	25	10	30

# Photovoltaic fuse links, fuse bases and holders

## PV-AF - Flush end, 1000 V d.c. (IEC/UL), 160 A to 400 A

### Specifications

#### Description

A range of flush end fuse links specifically designed for protecting and isolating photovoltaic array combiners and disconnects. These fuse links are capable of interrupting low overrated currents associated with faulted PV systems (reverse rated current, multi-array fault).

#### Technical data

- Rated voltage: 1000 V d.c. (IEC and UL)
- Rated current: 160 A to 400 A
- Breaking capacity: 50 kA
- Operating class: gPV and UL PV fuse links



#### Standards / Agency information

IEC 60269-6, UL 2579 (file number E335324), CSA Listed, RoHS compliant

#### Catalogue numbers

Fuse link type	Fuse link body size	Rated voltage	Rated current (Amps)	I <sub>t</sub> (A <sup>2</sup> Sec)		Watts loss (W)		Catalogue numbers
				Pre-arcing	Total at 1000 V d.c.	0.8 I <sub>n</sub>	I <sub>n</sub>	
Flush end	2	1000 V d.c.(IEC/UL)	160	4600	37,000	15	30	PV-160AF2
			200	9500	76,000	17	34	PV-200AF2
			250	17,000	136,000	19	38	PV-250AF2
	3	1000 V d.c.(IEC/UL)	315	27,000	240,000	30	49	PV-315AF3
			355	37,000	350,000	31	51	PV-355AF3
			400	61,500	550,000	32	52	PV-400AF3

#### Dimensions (mm) - Size 2

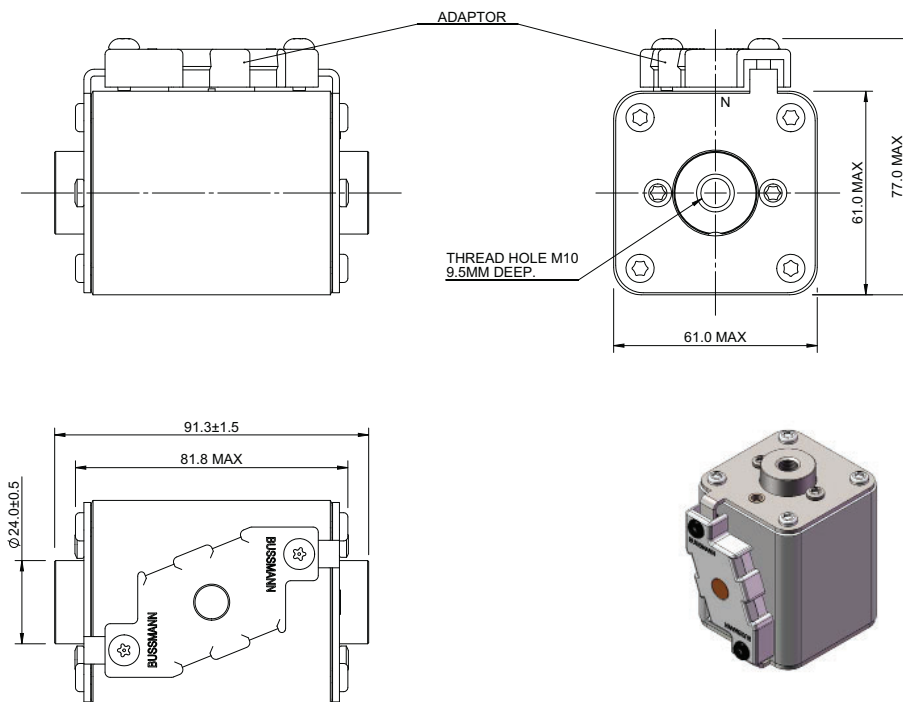

Data sheet: 10370

**PV-AF - Flush end, 1000 V d.c. (IEC/UL), 160 A to 400 A**

**Dimensions (mm) - Size 3**

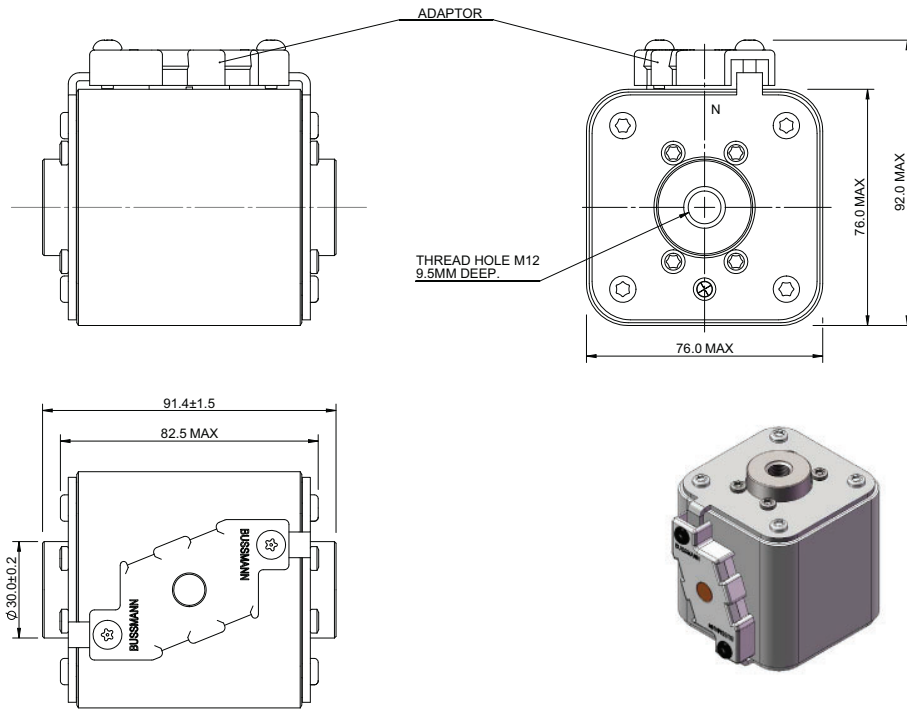

**Time-current curve - Size 2, 160 A to 250 A**

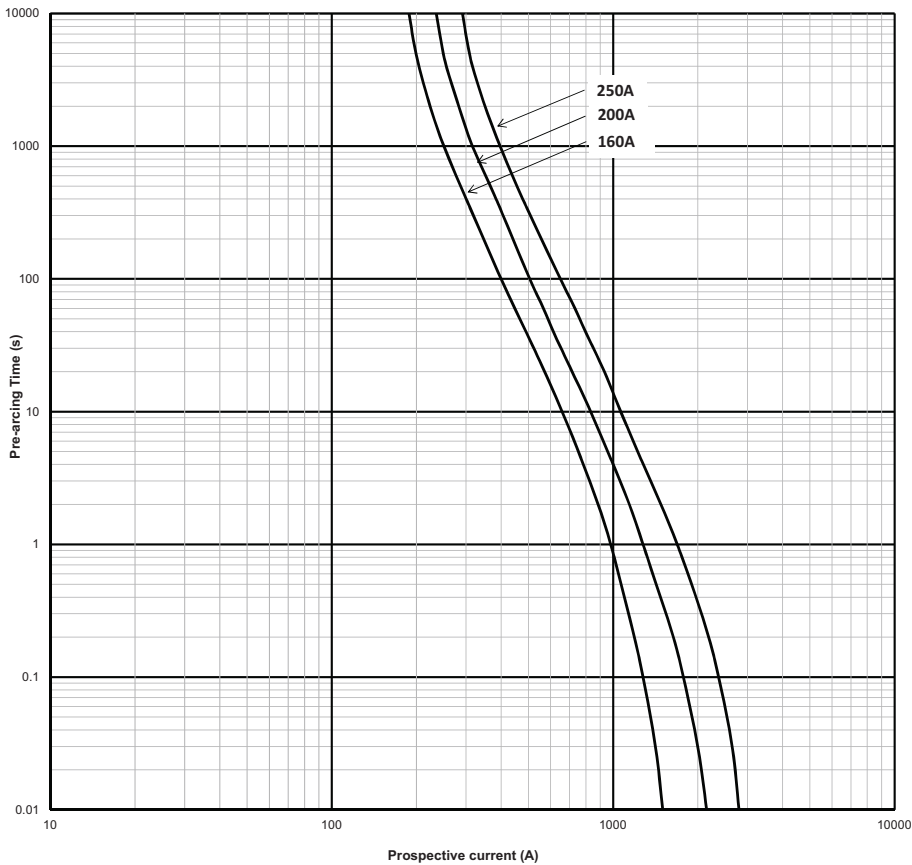

# Photovoltaic fuse links, fuse bases and holders

## PV-AF - Flush end, 1000 V d.c. (IEC/UL), 160 A to 400 A

### Time-current curve - Size 3, 315 A to 400 A

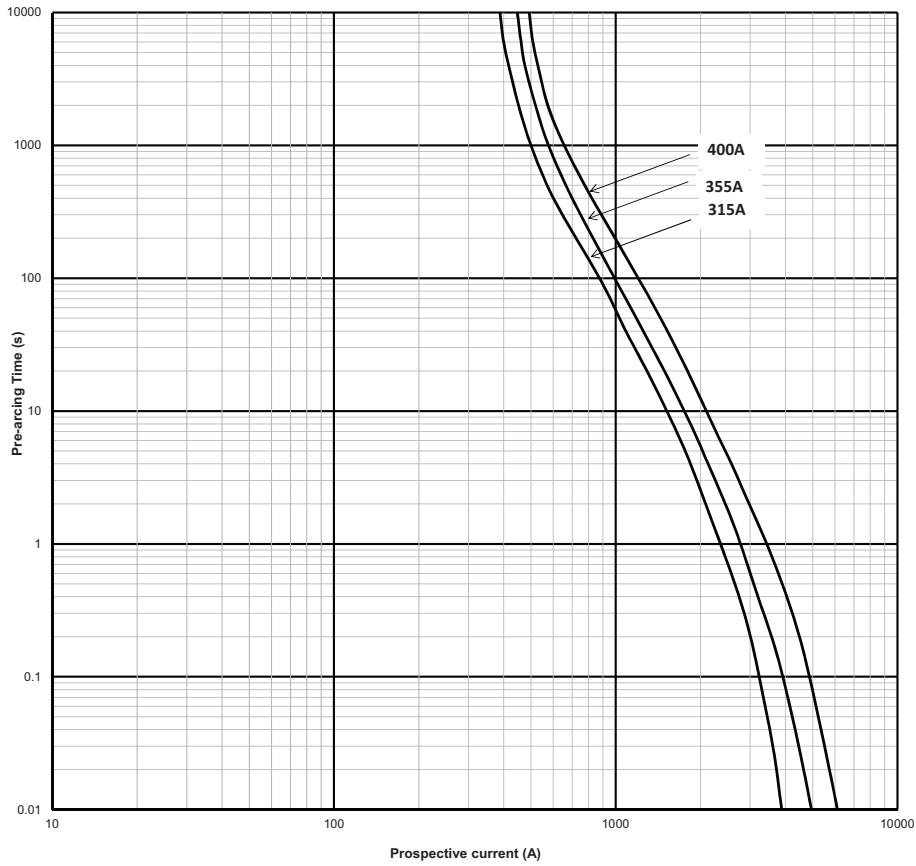

## PV-XL - XL Style, 1000-1500 V d.c. (IEC/UL), 50 A to 600 A

### Specifications

#### Description

A range of XL package bladed fuse links specifically designed for protecting and isolating photovoltaic array combiners and disconnects. These fuse links are capable of interrupting low overrated currents associated with faulted PV systems (reverse rated current, multi-array fault).

#### Technical data

- Rated voltage:
  - 1000 V d.c. (IEC and UL 63 to 600 A)
  - 1500 V d.c. (IEC and UL 50 to 400 A)
- Rated current: 50 A to 600 A
- Breaking capacity: see catalogue numbers tables
- Operating class: gPV and UL PV fuse links

#### Compatible fuse base

- SD-S-PV

#### Microswitches

- For bladed fuse links
  - 170H0235 or 170H0237 for 01XL
  - 170H0236 or 170H0238 for 1XL, 2XL and 3L
- For bolted fuse links
  - 170H0069 for all sizes

#### Standards / Agency information

IEC 60269-6, UL Recognised file 2579 E335324, RoHS compliant



#### Catalogue numbers - PV-XL fuse links, 1000 V d.c.

Fuse link body size	Rated voltage	Rated current (Amps)	Breaking capacity (IEC/UL) (kA)	I <sup>2</sup> t (A <sup>2</sup> Sec)		Watts loss (W)		Catalogue numbers	
				Pre-arcing	Total at 1000 V d.c.	0.7 I <sub>n</sub>	I <sub>n</sub>	Bladed version	Bolted version
01	1000 V d.c.	63	50	260	1900	10	24	PV-63A-01XL	PV-63A-01XL-B
		80	50	490	3600	12	29	PV-80A-01XL	PV-80A-01XL-B
		100	50	870	6300	13	32	PV-100A-01XL	PV-100A-01XL-B
		125	50	1930	13,900	16	40	PV-125A-01XL	PV-125A-01XL-B
		160	50	3900	28,100	18	44	PV-160A-01XL	PV-160A-01XL-B
		160	33	2780	21,000	18	44	PV-160A-2XL	PV-160A-2XL-B
		200	33	4950	37,000	20	50	PV-200A-2XL	PV-200A-2XL-B
		250	33	9450	70,000	24	60	PV-250A-2XL	PV-250A-2XL-B
2	1000 V d.c.	315	33	16,600	123,000	26	66	PV-315A-2XL	PV-315A-2XL-B
		355	33	26,000	192,000	27	68	PV-355A-2XL	PV-355A-2XL-B
		160	33	2780	21,000	18	44		PV-160A-2XL-3B <sup>1</sup>
		200	33	4950	37,000	20	50		PV-200A-2XL-3B <sup>1</sup>
		250	33	9450	70,000	24	60		PV-250A-2XL-3B <sup>1</sup>
		315	33	16,600	123,000	26	66		PV-315A-2XL-3B <sup>1</sup>
3	1000 V d.c.	355	33	26,000	192,000	27	68		PV-355A-2XL-3B <sup>1</sup>
		350	50	31,000	161,200	26	65	PV-350A-3L	PV-350A-3L-B
		400	50	44,500	231,400	33	82	PV-400A-3L	PV-400A-3L-B
		500	50	85,000	442,000	34	85	PV-500A-3L	PV-500A-3L-B
		600	50	137,000	712,400	43	108	PV-600A-3L	PV-600A-3L-B

<sup>1</sup> PV-\*A-2XL-3B and PV-\*A-2XL-3B-15 have revised bolting patterns, which are identical to size 3L bolting pattern. This allows utilisation of both size 2XL and size 3L fuse links without changing the dimensional layout of the inverter, combiners and disconnects.

# Photovoltaic fuse links, fuse bases and holders

## PV-XL - XL Style - 1000-1500 V d.c. (IEC/UL), 50 A to 600 A

Catalogue numbers - PV-XL fuse links, 1500 V d.c.

Fuse link body size	Rated voltage	Rated current (Amps)	Breaking capacity (IEC/UL) (kA)	I <sup>2</sup> t (A <sup>2</sup> Sec)		Watts loss (W)		Catalogue numbers			
				Pre-arcing	Total at 1500 V <sup>1</sup>	0.7 I <sub>n</sub>	I <sub>n</sub>	Bladed with top indicator	Bladed without top indicator	Bolted version with side indicator	Bolted without side indicator
01	1500 V d.c.	50	30	175	1000	10	25	PV-50A-01XL-15		PV-50A-01XL-B-15	
		63	30	362	2250	10	26	PV-63A-01XL-15		PV-63A-01XL-B-15	
		80	30	565	3300	14	35	PV-80A-01XL-15		PV-80A-01XL-B-15	
		100	30	1100	6600	16	40	PV-100A-01XL-15		PV-100A-01XL-B-15	
		125	30	2200	10,500	18	44	PV-125A-01XL-15		PV-125A-01XL-B-15	
1	1500 V d.c.	100	30	1250	6000	24	43	PV-100A-1XL-15		PV-100A-1XL-B-15	
		125	30	1950	9360	25	52	PV-125A-1XL-15		PV-125A-1XL-B-15	
		160	30	4200	20,160	26	54	PV-160A-1XL-15		PV-160A-1XL-B-15	
		200	30	9400	45,120	31	60	PV-200A-1XL-15		PV-200A-1XL-B-15	
		125	30	2200	15,000	18	44	PV-125A-2XL-15	PV-125A-2XL-U-15	PV-125A-2XL-B-15	PV-125A-2XL-BU-15
2	1500 V d.c.	160	30	5000	32,000	19	48	PV-160A-2XL-15	PV-160A-2XL-U-15	PV-160A-2XL-B-15	PV-160A-2XL-BU-15
		200	30	8800	51,000	23	57	PV-200A-2XL-15	PV-200A-2XL-U-15	PV-200A-2XL-B-15	PV-200A-2XL-BU-15
		250	30	16,600	85,000	28	70	PV-250A-2XL-15	PV-250A-2XL-U-15	PV-250A-2XL-B-15	PV-250A-2XL-BU-15
		125	30	2200	15,000	18	44			PV-125A-2XL-3B-15 <sup>1</sup>	PV-125A-2XL-3BU-15 <sup>1</sup>
		160	30	5000	32,000	19	48			PV-160A-2XL-3B-15 <sup>1</sup>	PV-160A-2XL-3BU-15 <sup>1</sup>
3	1500 V d.c.	200	30	8800	51,000	23	57			PV-200A-2XL-3B-15 <sup>1</sup>	PV-200A-2XL-3BU-15 <sup>1</sup>
		250	30	16,600	85,000	28	70			PV-250A-2XL-3B-15 <sup>1</sup>	PV-250A-2XL-3BU-15 <sup>1</sup>
		250	100 <sup>2</sup>	74,000	263,000	20	49	PV-250A-3L-15	PV-250A-3L-U-15	PV-250A-3L-B-15	PV-250A-3L-BU-15
		315	100 <sup>2</sup>	150,000	533,000	21	52	PV-315A-3L-15	PV-315A-3L-U-15	PV-315A-3L-B-15	PV-315A-3L-BU-15
		350	100 <sup>2</sup>	195,000	693,000	24	59	PV-350A-3L-15	PV-350A-3L-U-15	PV-350A-3L-B-15	PV-350A-3L-BU-15
	1500 V d.c.	355	100 <sup>2</sup>	195,000	693,000	24	59	PV-355A-3L-15	PV-355A-3L-U-15	PV-355A-3L-B-15	PV-355A-3L-BU-15
		400	100 <sup>2</sup>	296,000	1,060,000	24	61	PV-400A-3L-15	PV-400A-3L-U-15	PV-400A-3L-B-15	PV-400A-3L-BU-15
		450	100 <sup>2</sup>	412,000	1,470,000	27	67	PV-450A-3L-15	PV-450A-3L-U-15	PV-450A-3L-B-15	PV-450A-3L-BU-15
		500	100 <sup>2</sup>	532,000	1,890,000	29	73	PV-500A-3L-15	PV-500A-3L-U-15	PV-500A-3L-B-15	PV-500A-3L-BU-15

<sup>1</sup> PV-\*A-2XL-3B and PV-\*A-2XL-3B-15 have revised bolting patterns, which are identical to size 3L bolting pattern. This allows utilisation of both size 2XL and size 3L fuse links without changing the dimensional layout of the inverter, combiners and disconnects.

<sup>2</sup> 100 kA at time constant 6 ms.

### Dimensions (mm) - Size 01, bladed

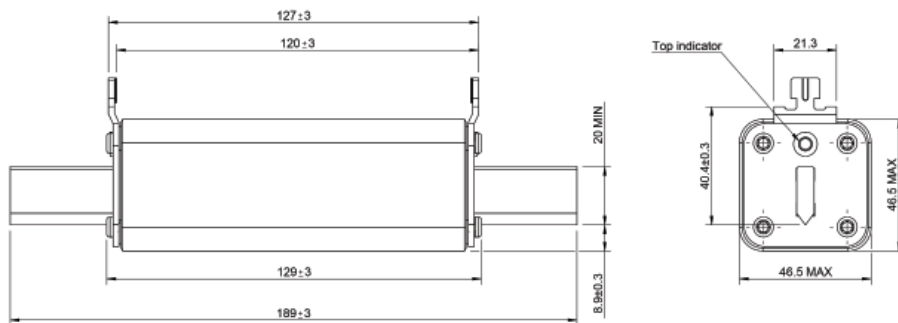

**PV-XL - XL Style - 1000-1500 V d.c. (IEC/UL), 50 A to 600 A**

**Dimensions (mm) - Size 1, bladed**

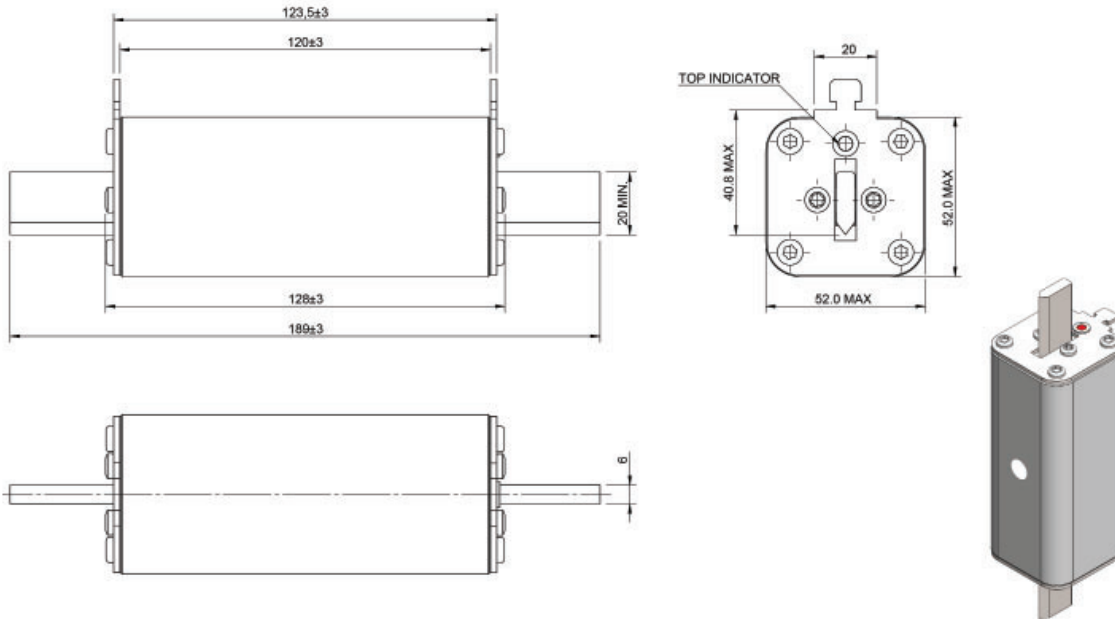

**Dimensions (mm) - Size 2, bladed**

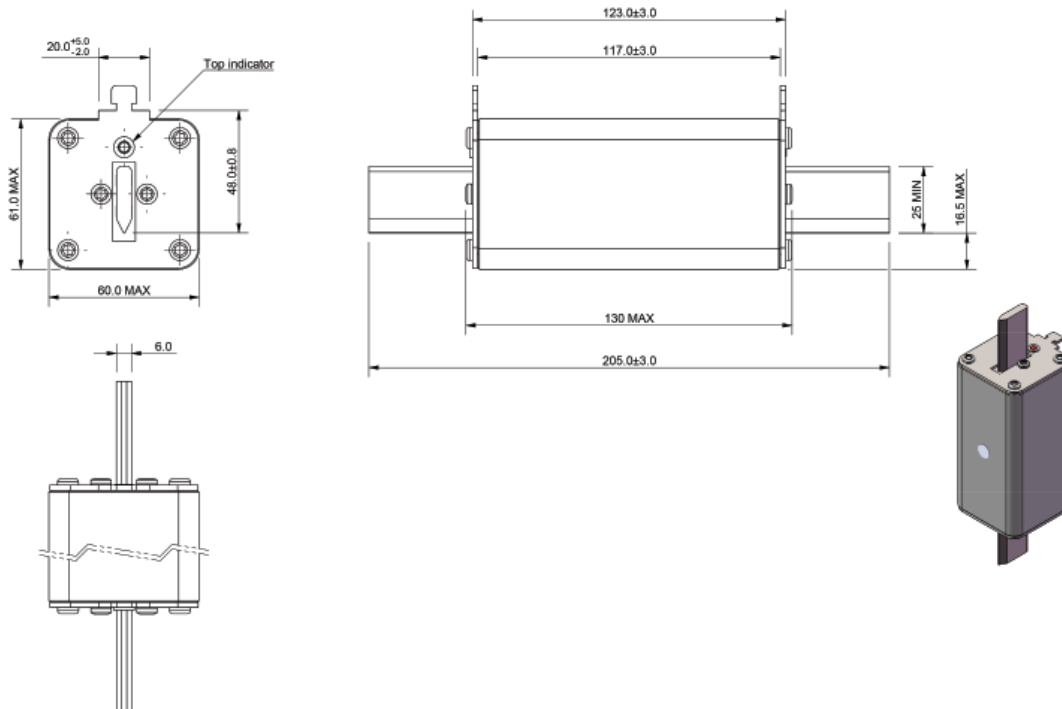

# Photovoltaic fuse links, fuse bases and holders

## PV-XL - XL Style - 1000-1500 V d.c. (IEC/UL), 50 A to 600 A

### Dimensions (mm) - Size 3, bladed

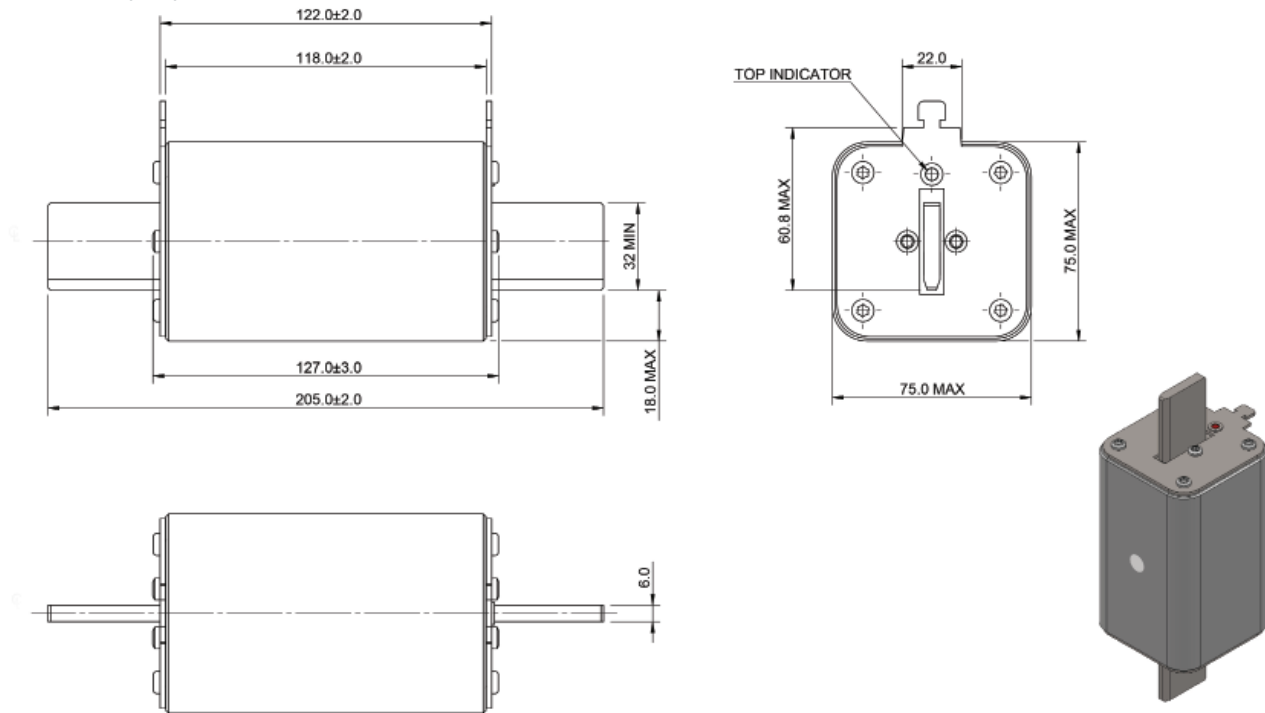

### Dimensions (mm) - Size 01, bolted

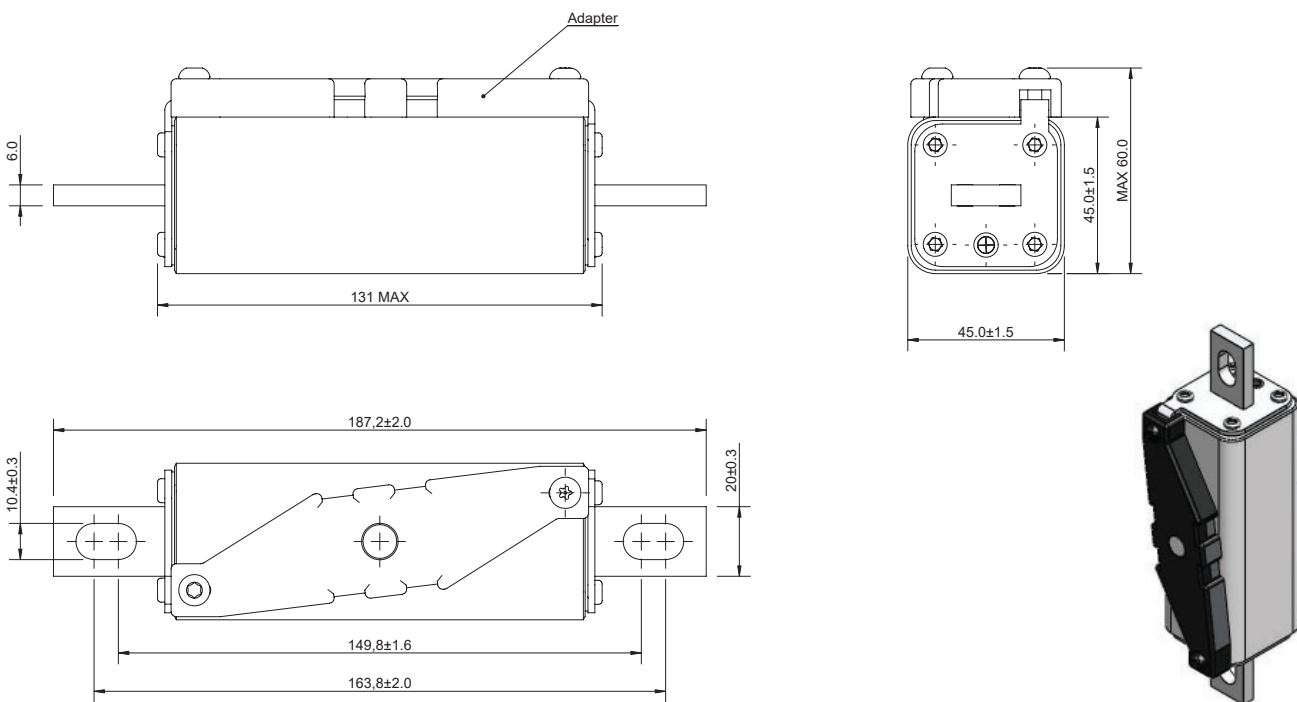



**PV-XL - XL Style - 1000-1500 V d.c. (IEC/UL), 50 A to 600 A**

**Dimensions (mm) - Size 1, bolted**

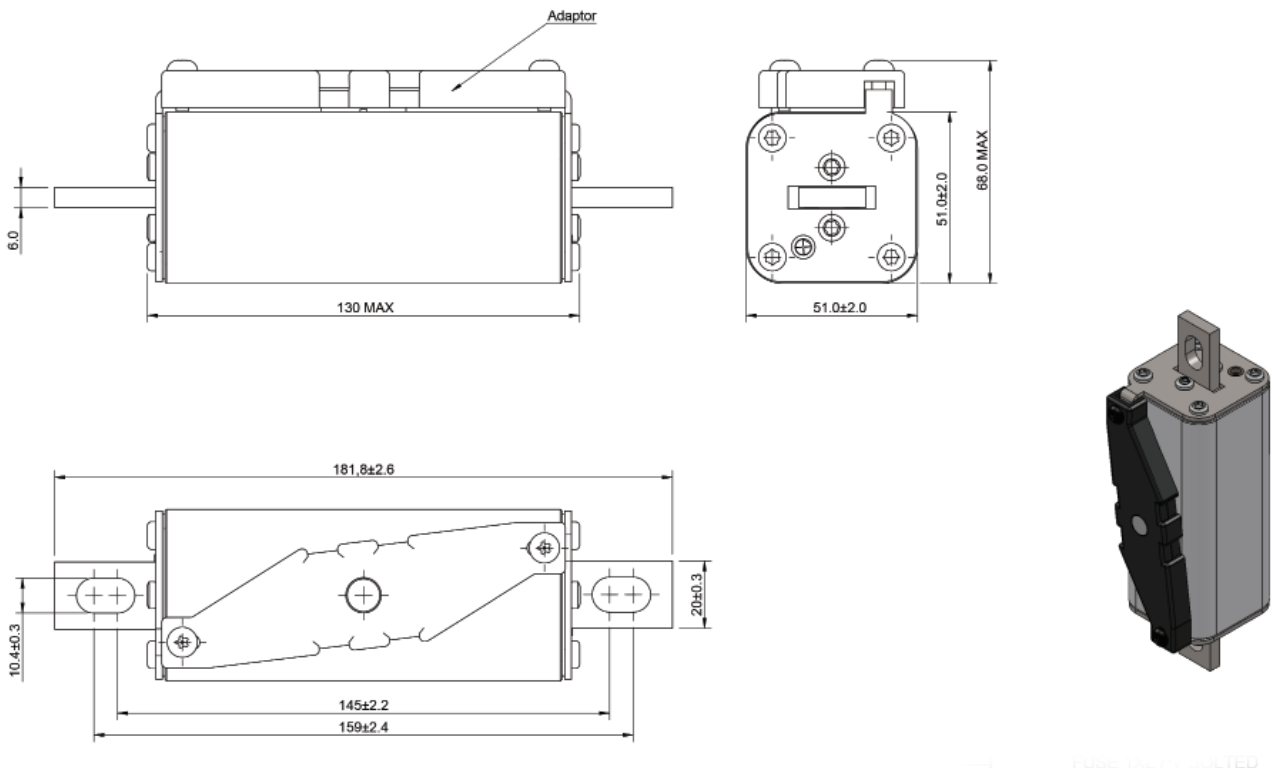

**Dimensions (mm) - Size 2, bolted**

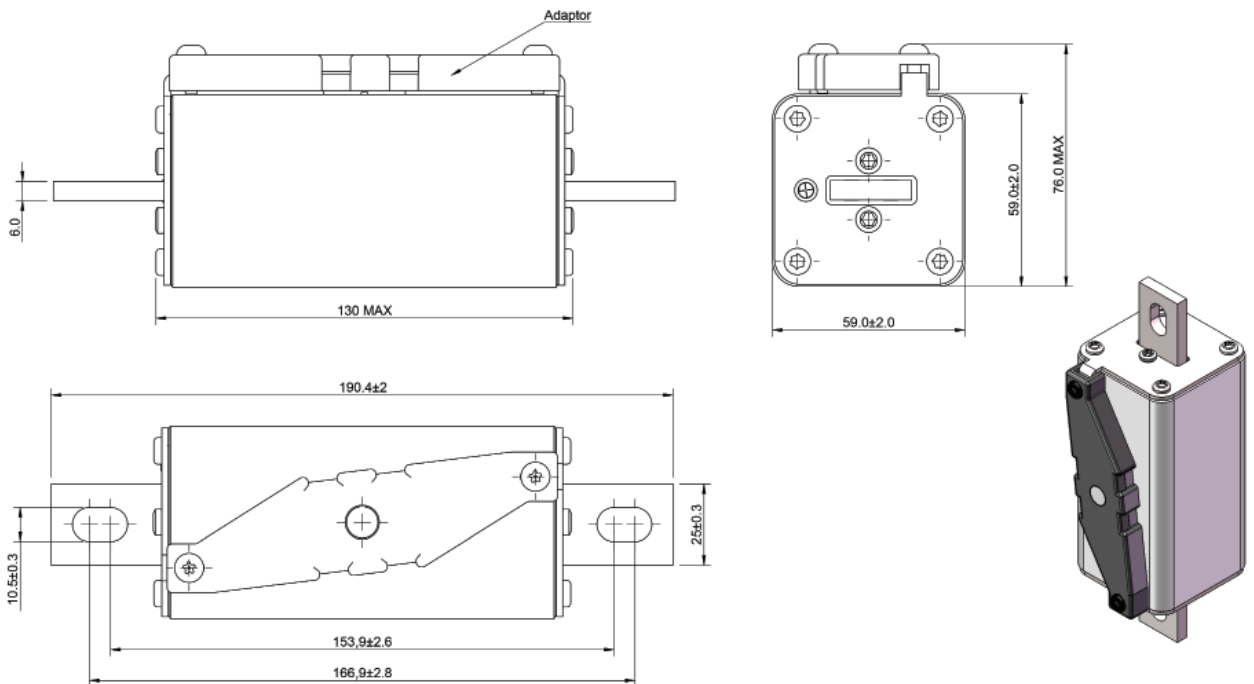

# Photovoltaic fuse links, fuse bases and holders

## PV-XL - XL Style - 1000-1500 V d.c. (IEC/UL), 50 A to 600 A

### Dimensions (mm) - Size 2XL-3B, bolted

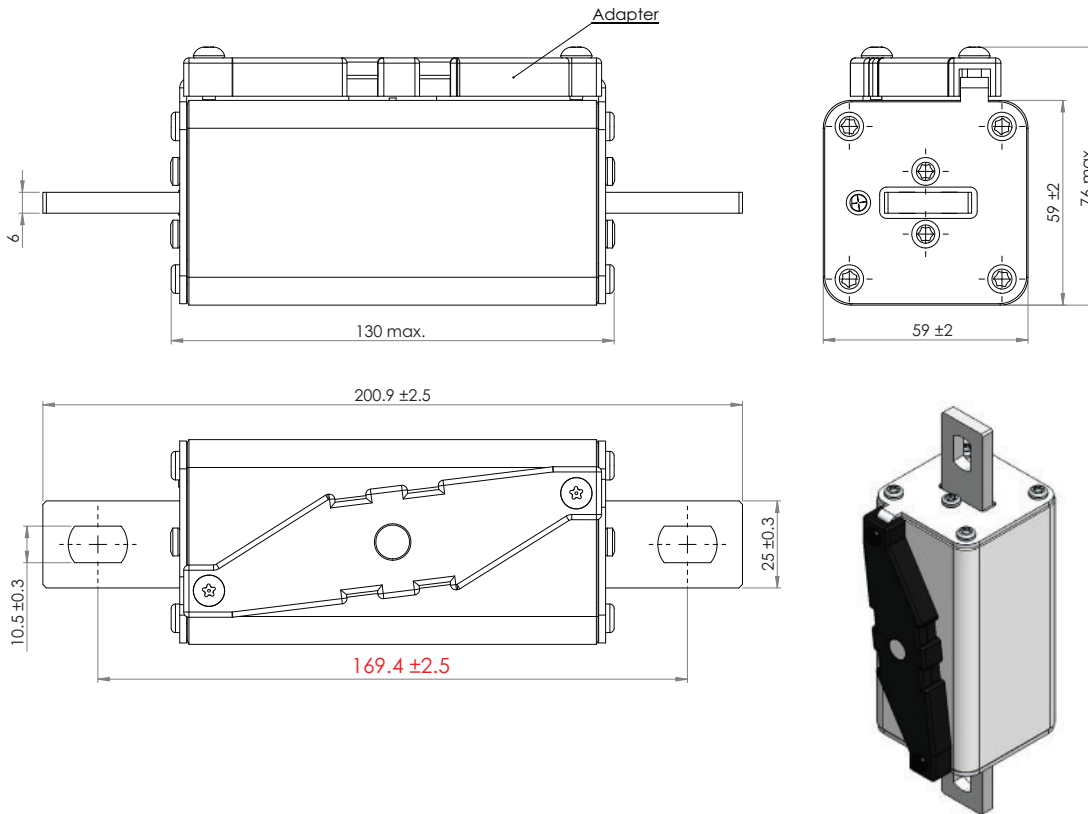

PV-\*A-2XL-3B and PV-\*A-2XL-3B-15 have revised bolting patterns, which are identical to size 3L bolting pattern. This allows utilisation of both size 2XL and size 3L fuse links without changing the dimensional layout of the inverter, combiners and disconnects.

Mounting dimensions comparison

2XL-3B	3L
169.4	170.8

### Dimensions (mm) - Size 3, bolted

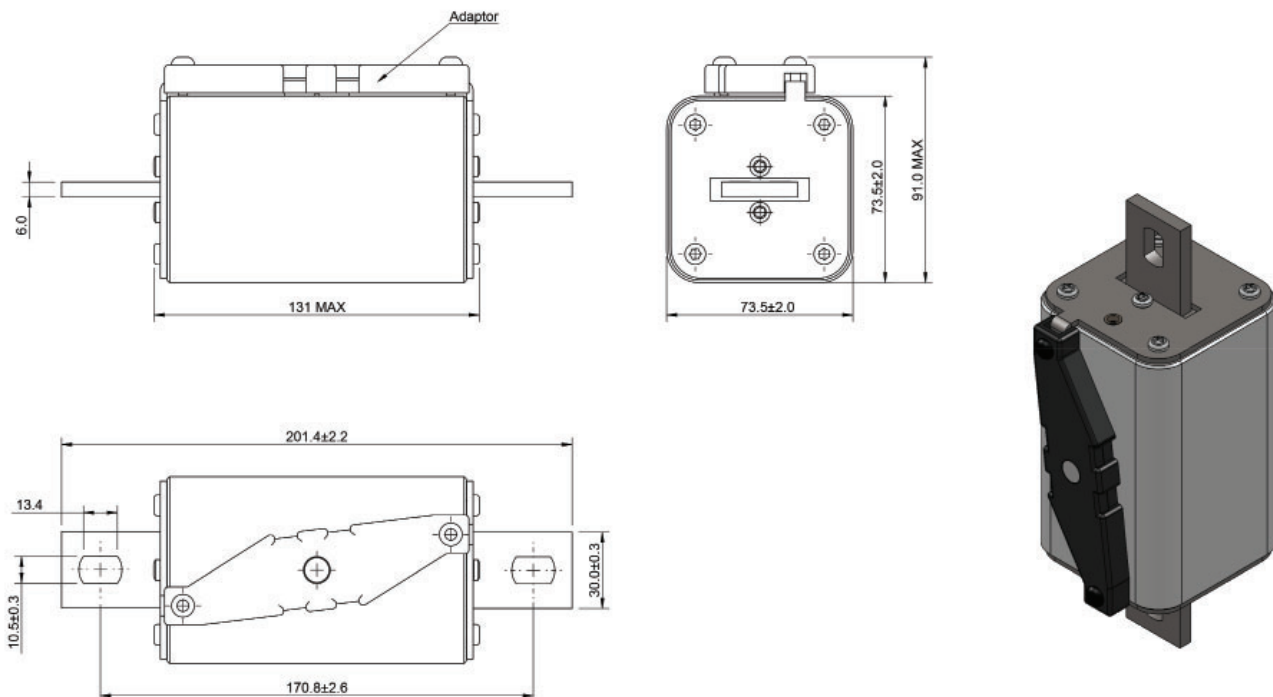

**PV-XL - XL Style - 1000-1500 V d.c. (IEC/UL), 50 A to 600 A**

**Time-current curve - Size 01XL, bladed and bolted, 1000 V d.c., 63 A to 160 A**

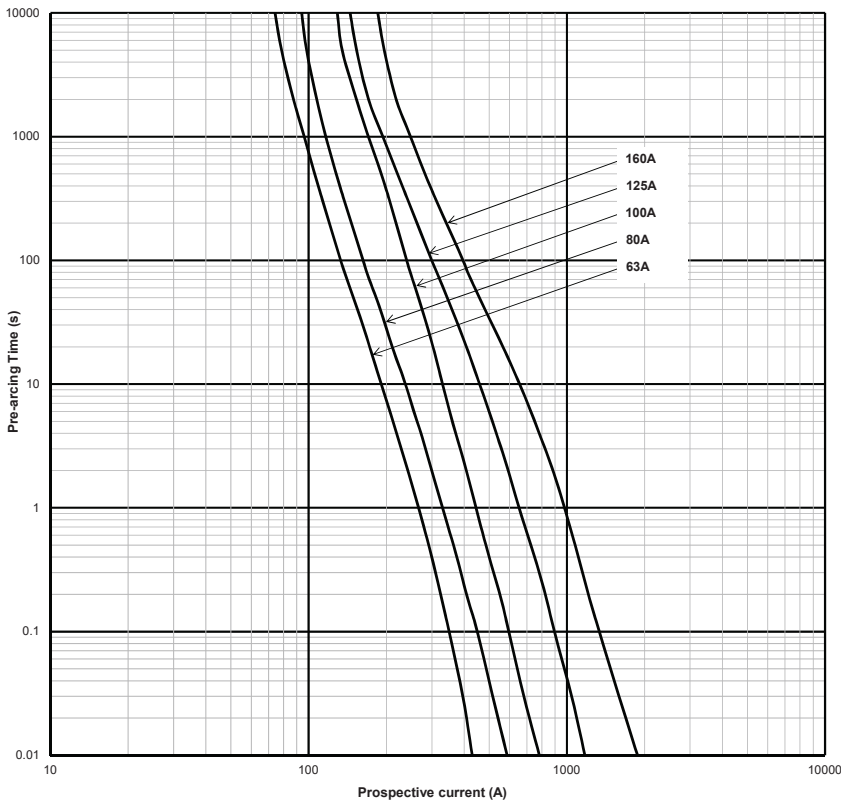

**Time-current curve - Size 2XL, bladed and bolted, 1000 V d.c., 160 A to 355 A**

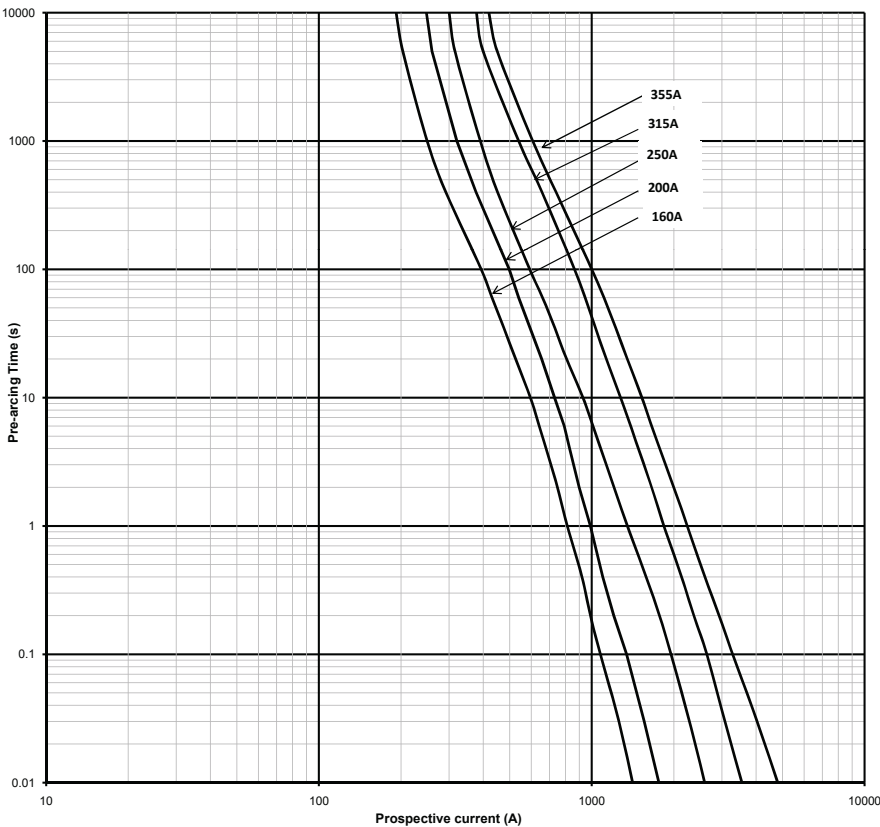

# Photovoltaic fuse links, fuse bases and holders

## PV-XL - XL Style - 1000-1500 V d.c. (IEC/UL), 50 A to 600 A

Time-current curve - Size 3L, bladed and bolted, 1000 V d.c., 350 A to 600 A

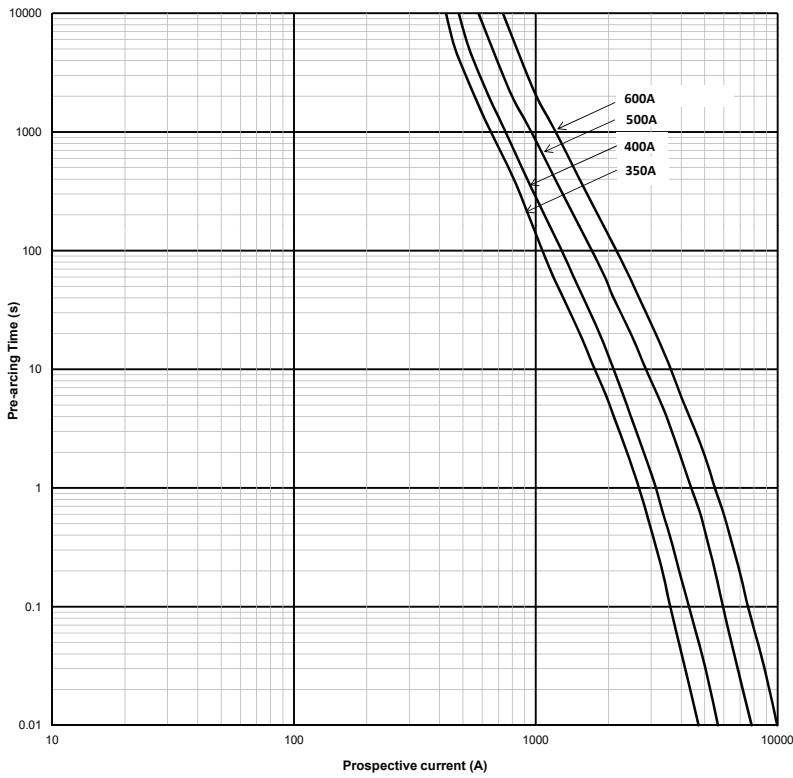

Time-current curve - Size 01XL, bladed and bolted, 1500 V d.c., 50 A to 125 A

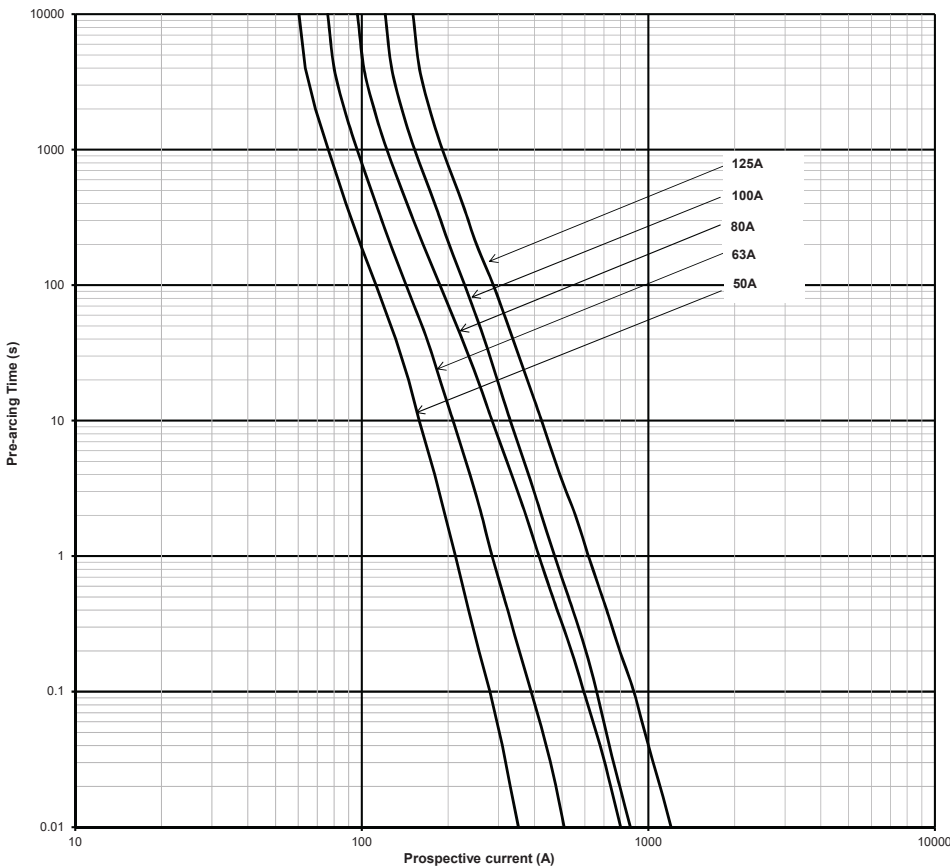

**PV-XL - XL Style - 1000-1500 V d.c. (IEC/UL), 50 A to 600 A**

**Time-current curve - Size 1XL, bladed and bolted, 1500 V d.c., 100 A to 200 A**

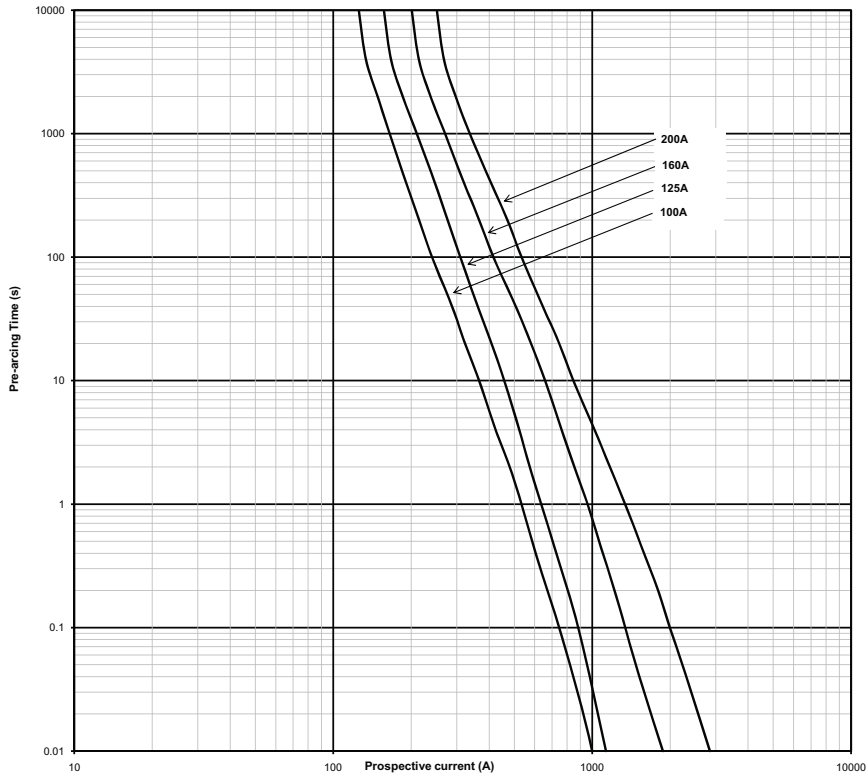

**Time-current curve - Size 2XL, bladed and bolted, 1500 V d.c., 125 A to 250 A**

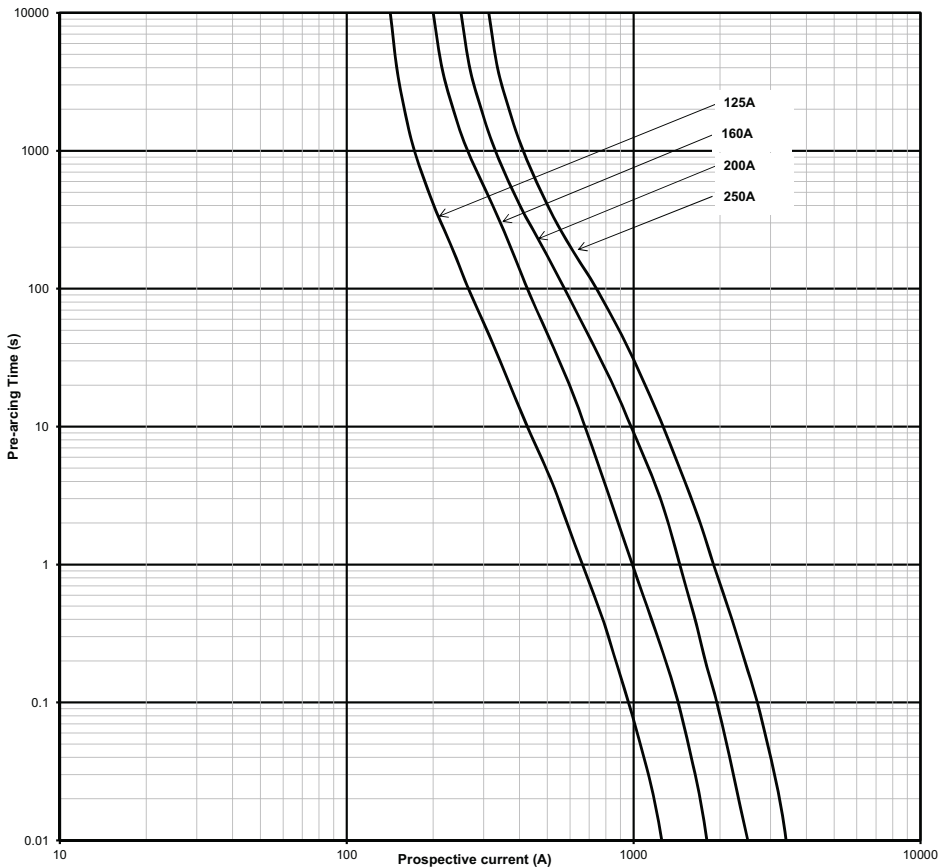

# Photovoltaic fuse links, fuse bases and holders

## PV-XL - XL Style - 1000-1500 V d.c. (IEC/UL), 50 A to 600 A

Time-current curve - Size 3L, bladed and bolted, 1500 V d.c., 250 A to 500 A

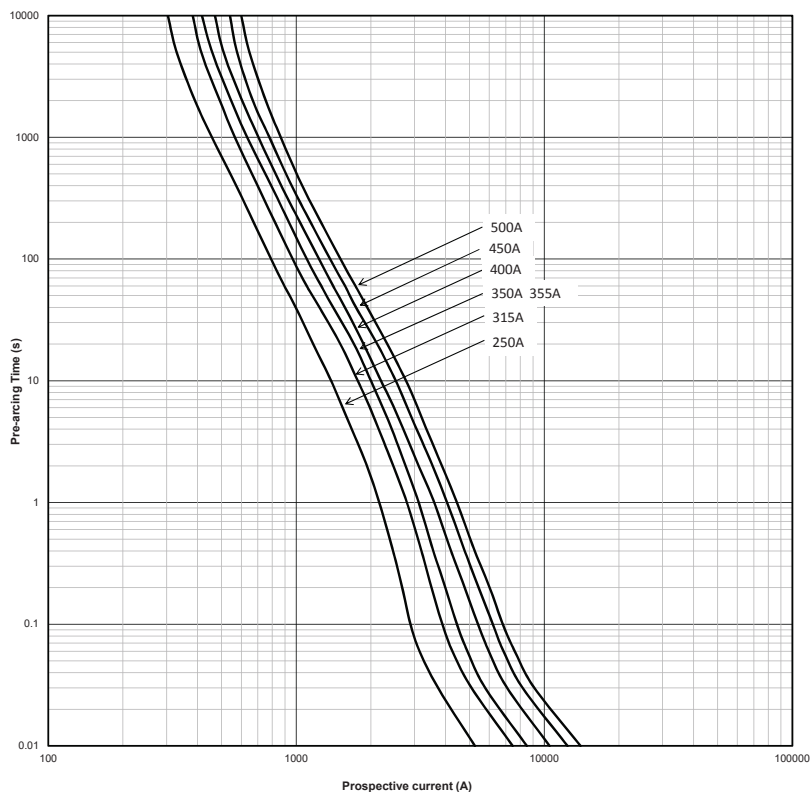

### Temperature derating curve

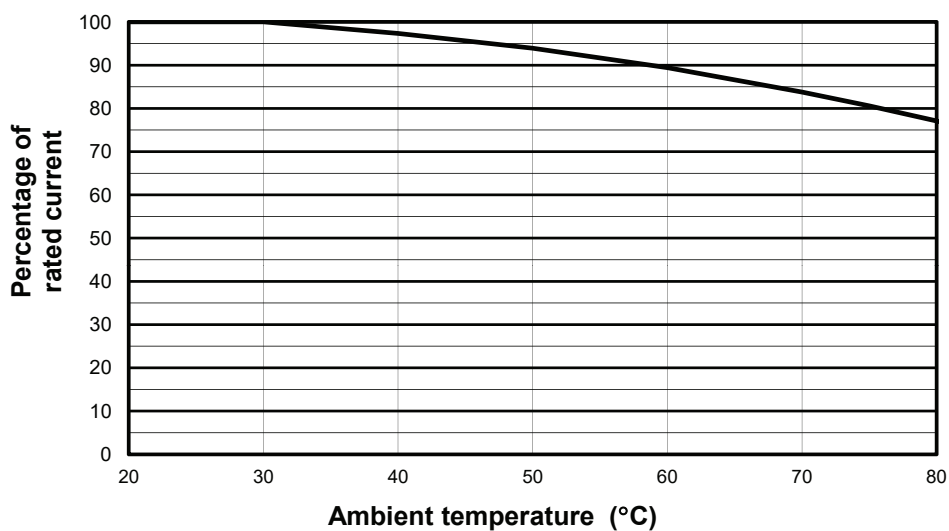

**SD-S-PV - XL fuse bases, 1500 V d.c. (IEC), 200 A to 500 A, sizes 1 to 3**

**Specifications**

**Description**

Sizes 1 to 3 XL Fuse bases specifically designed for use with the Bussmann series range of XL PV (Photovoltaic) fuse links.

**Technical data**

- Rated voltage: 1500 V d.c. (IEC)
- Rated current: 200 A, 400 A and 630 A
- Fuse base size: 1 to 3
- Compatible fuse links: PV XL

**Standards / Agency information**

- IEC 60269-1
- UL Listed (file number E348242)

**Accessories:**

Fuse extraction handle available in sizes 01XL to 3L

Part numbers: FEH1500B

Unit packing: 1



**Dimensions (mm)**

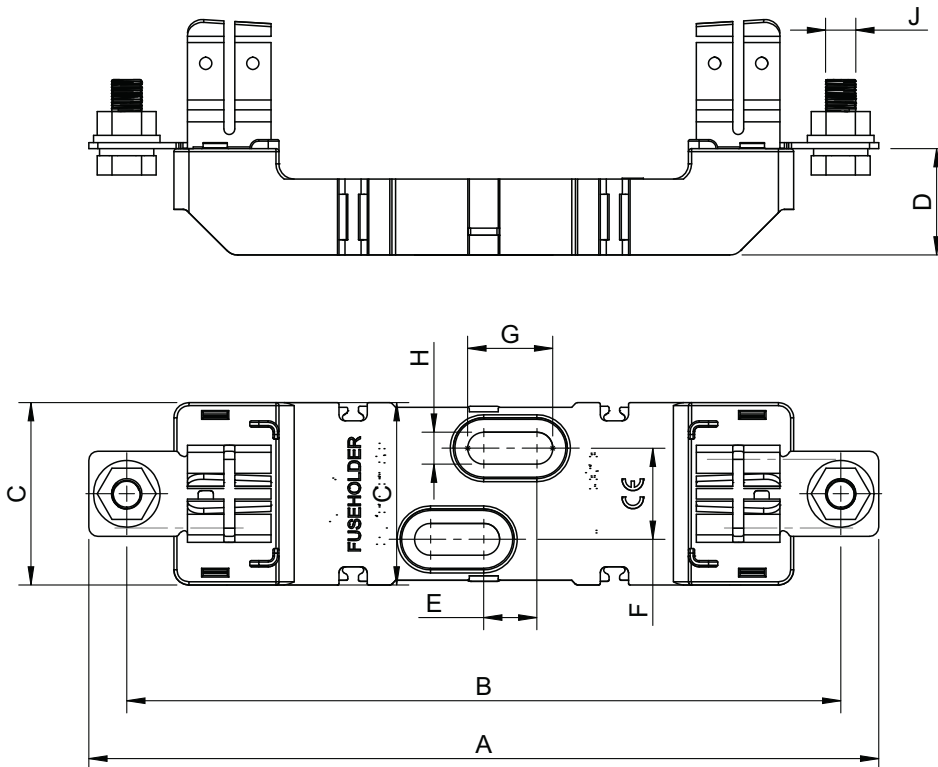

Catalogue numbers	XL Style fuse link size	Maximum fuse rated current (Amps)	Power acceptance	A	B	C	D	E	F	G	H	J
SD1XL-S-PV	01XL, 1XL	200	57W	260	235	60	35	17.5	30	28	10.5	M10
SD2XL-S-PV	2XL	400	75W	285	260	60	35	17.5	30	28	10.5	M12
SD3L-S-PV	3L	500	108W	300	270	60	35	17.5	30	28	10.5	M12

# Battery storage fuse links

## BSF-NH - NH Style, 1000 V d.c. (IEC/UL), 63 A to 400 A

### Specifications

#### Description

Eaton's Bussmann series NH battery storage fuses are specifically designed to protect and isolate battery array combiners and disconnects. These fuse links are capable of interrupting low overcurrents associated with faulted battery storage systems (reverse current, multi-array fault).

#### Technical data

- Rated voltage: 1000 V d.c.
- Rated current: 63 A to 400 A
- Operating class: gBat proposed for full range fuse links for protection of battery storage systems
- Breaking capacity: 100 kA
- Time constant: 4.5 ms at 100 kA

#### Microswitches

- For bladed fuse links only
  - 170H0236
  - 170H0238

#### Fuse holders

- For bladed fuse links only
  - SD1-D-PV
  - SD2-D-PV
  - SD3-D-PV

#### Standards / Agency information

IEC 60269-7 for battery storage fuse links is under preparation.



### Catalogue numbers

Fuse link body size	Rated voltage	Rated current (Amps)	I <sup>2</sup> t (A <sup>2</sup> Sec)		Watts loss (W)		Catalogue numbers	
			Pre-arcing	Total at 1000 V d.c.	0.7 I <sub>n</sub>	I <sub>n</sub>	Bladed version	Bolted version
1	1000 V d.c.	63	470	4300	5	12	BSF-063G-NH110	BSF-063G-NH110-B
		80	640	5760	6	15.5	BSF-080G-NH110	BSF-080G-NH110-B
		100	1300	11,700	7	16.5	BSF-100G-NH110	BSF-100G-NH110-B
		125	2600	23,400	7	17.5	BSF-125G-NH110	BSF-125G-NH110-B
		160	5200	46,800	11	27.5	BSF-160G-NH110	BSF-160G-NH110-B
		200	10,200	82,000	10	25	BSF-200G-NH110	BSF-200G-NH110-B
2	1000 V d.c.	160	4600	37,000	11	28	BSF-160G-NH210	BSF-160G-NH210-B
		200	9500	76,000	13	32	BSF-200G-NH210	BSF-200G-NH210-B
		250	17,000	136,000	15	38	BSF-250G-NH210	BSF-250G-NH210-B
3	1000 V d.c.	315	32,000	260,000	18	44	BSF-315G-NH310	BSF-315G-NH310-B
		355	44,500	370,000	18	46	BSF-355G-NH310	BSF-355G-NH310-B
		400	67,500	550,000	20	50	BSF-400G-NH310	BSF-400G-NH310-B



**BSF-NH - NH Style, 1000 V d.c. (IEC/UL), 63 A to 400 A**

**Dimensions (mm) - Size 1, bladed**

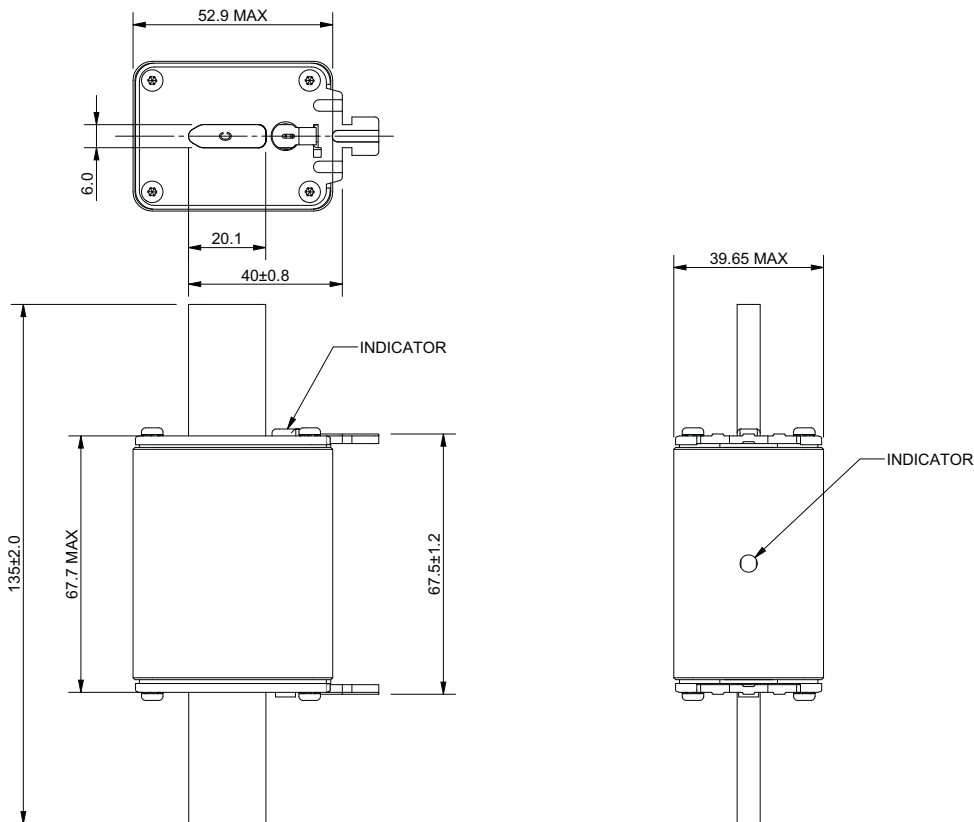

**Dimensions (mm) - Size 2, bladed**

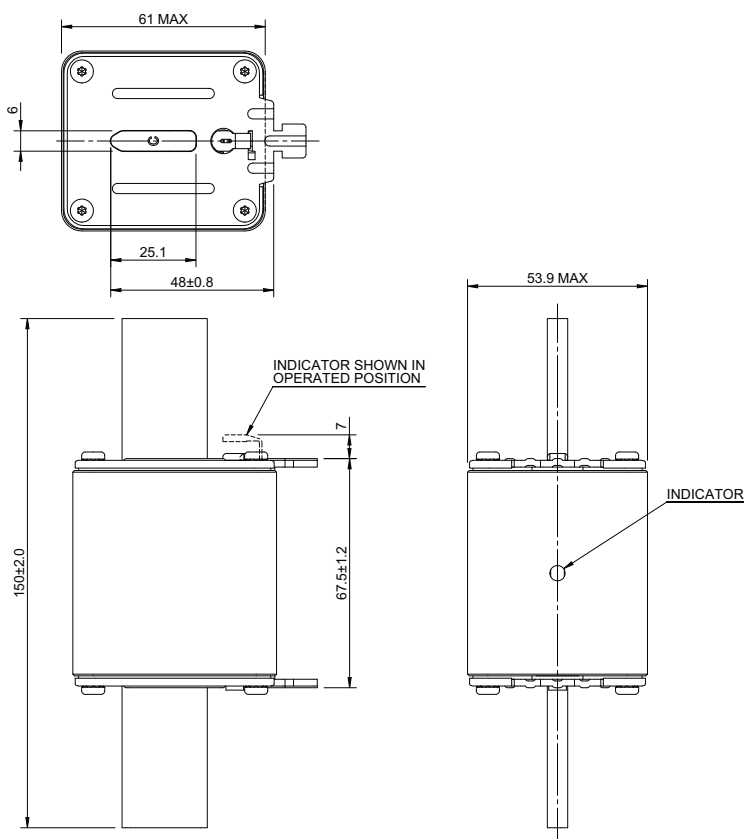

Data sheet: 135001

# Battery storage fuse links

## BSF-NH - NH Style, 1000 V d.c. (IEC/UL), 63 A to 400 A

### Dimensions (mm) - Size 3, bladed

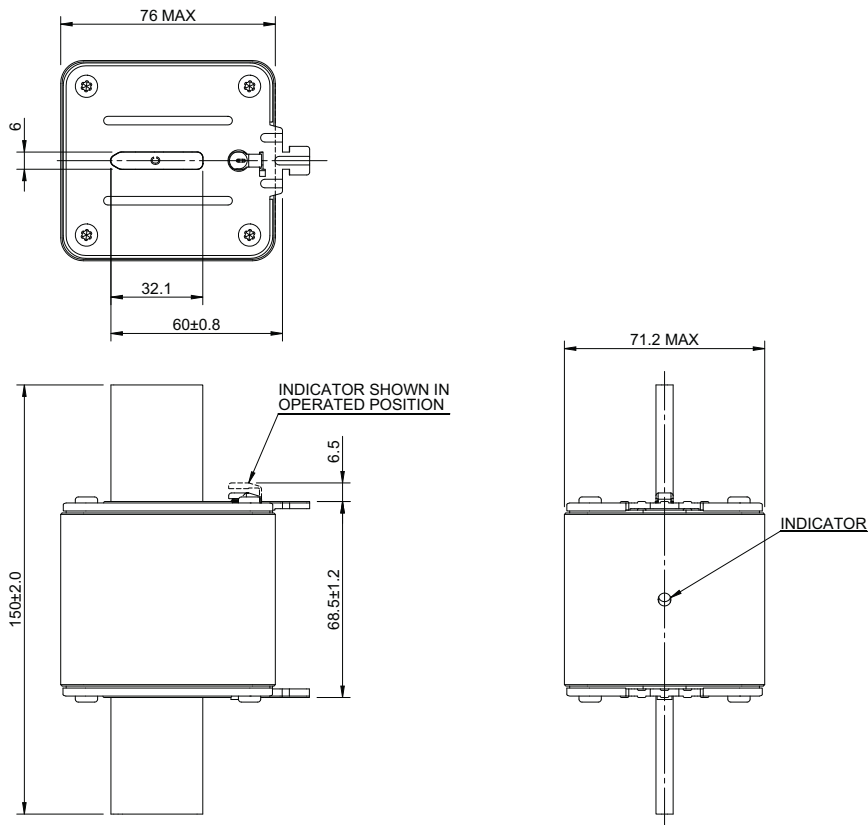

### Dimensions (mm) - Size 1, bolted

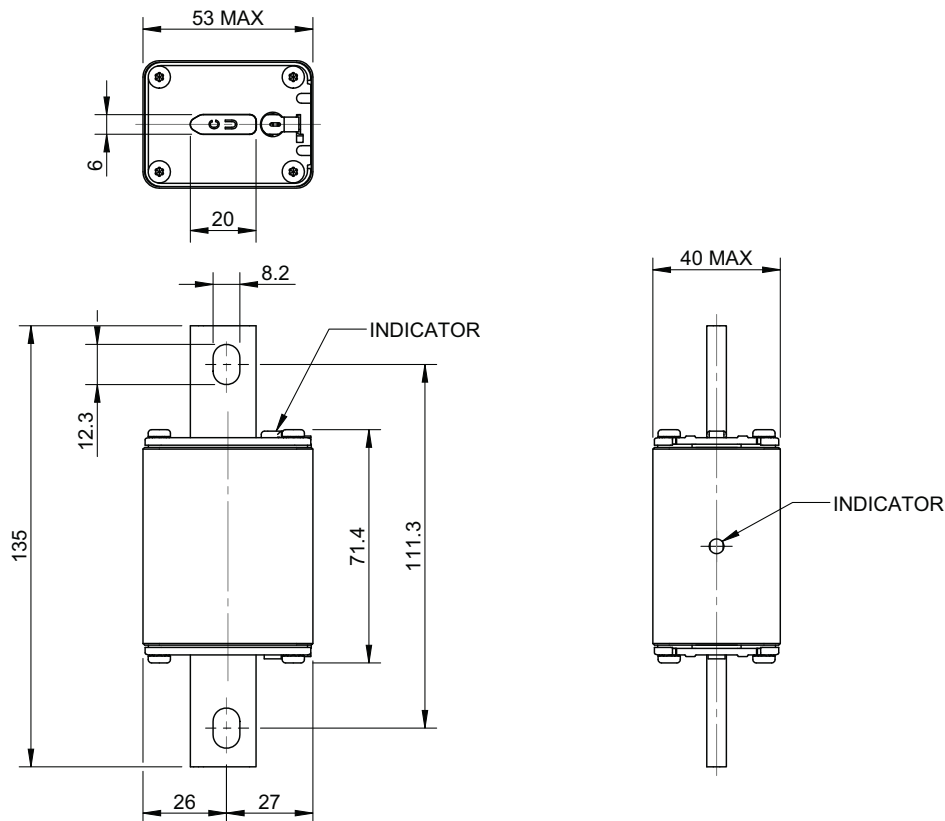

**BSF-NH - NH Style, 1000 V d.c. (IEC/UL), 63 A to 400 A**

**Dimensions (mm)- Size 2, bolted**

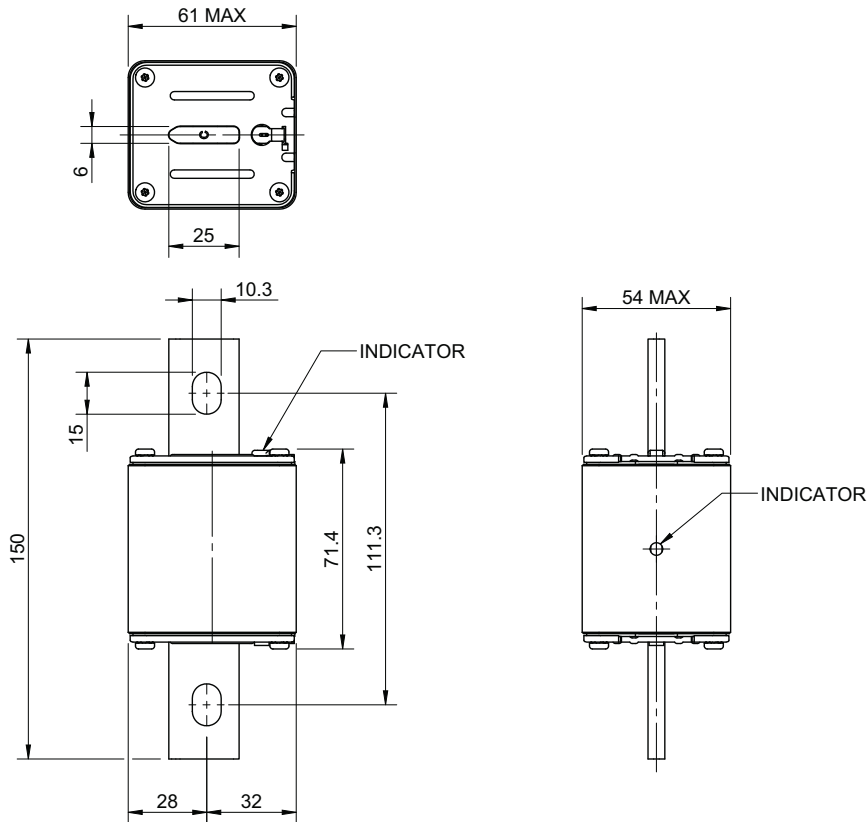

**Dimensions (mm) - Size 3, bolted**

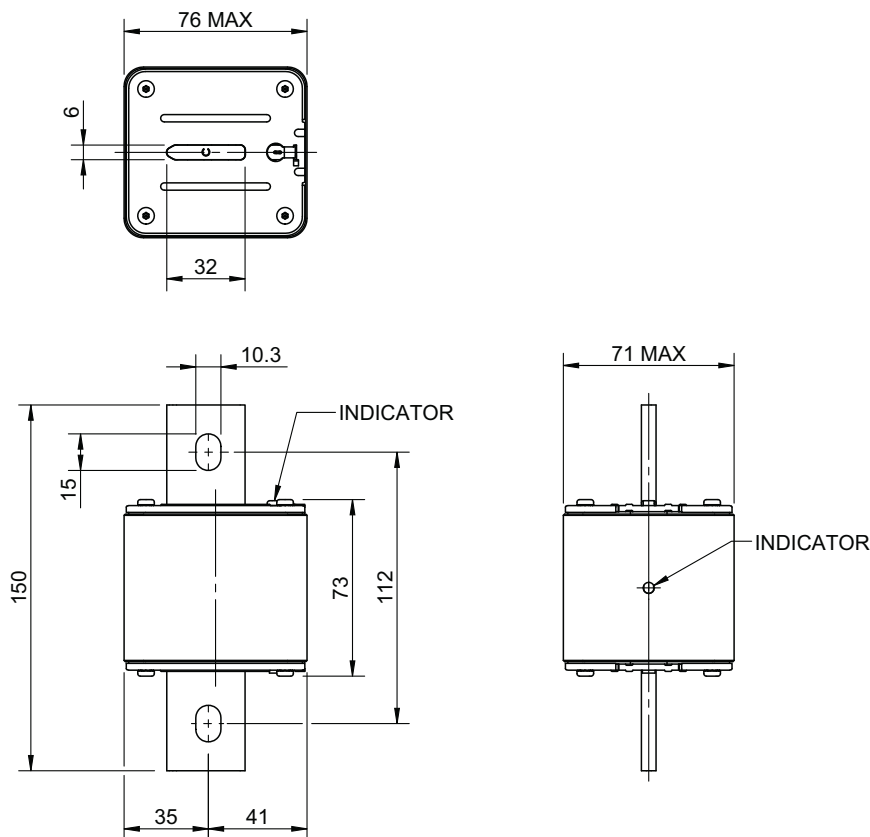

# Battery storage fuse links

## BSF-NH - NH Style, 1000 V d.c. (IEC/UL), 63 A to 400 A

Time-current curve - Size 1, 63 A to 200 A

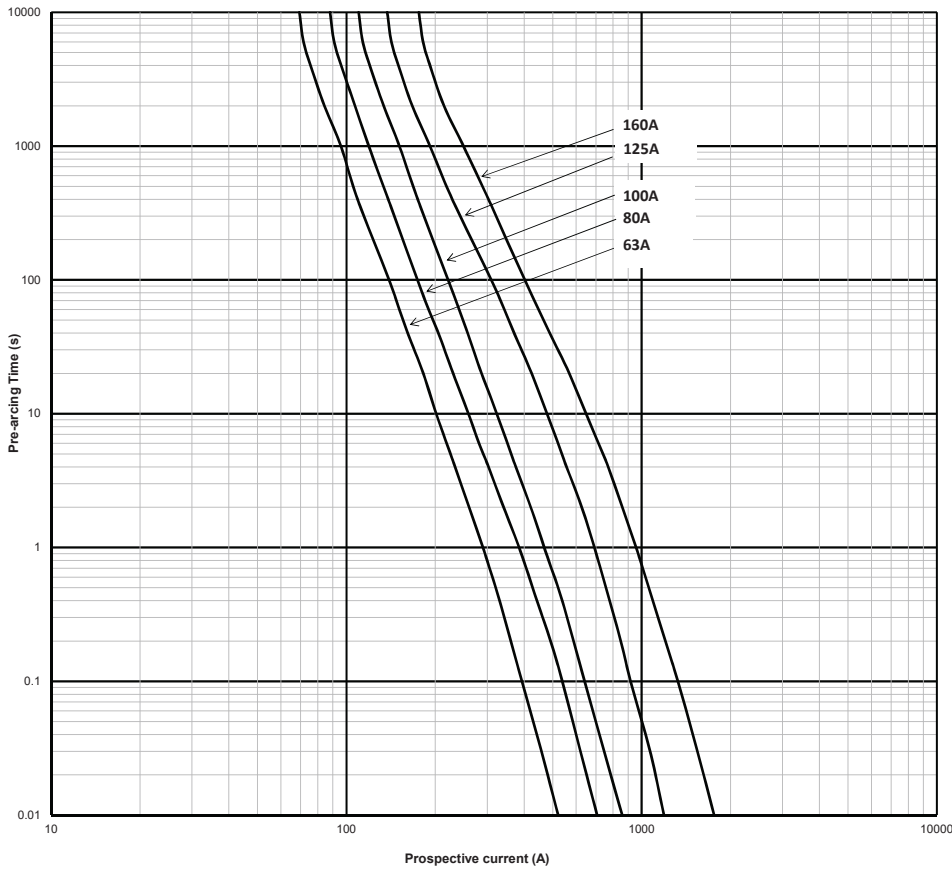

Time-current curve - Size 2, 160 A to 250 A

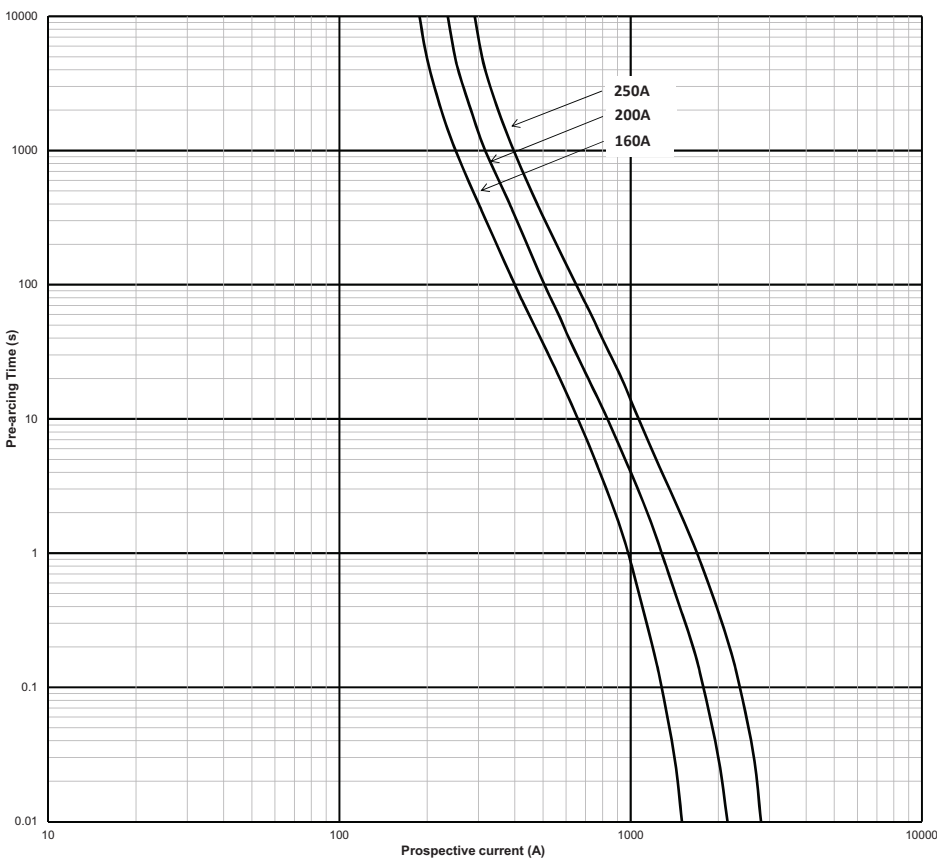

Data sheet: 135001

**BSF-NH - NH Style, 1000 V d.c. (IEC/UL), 63 A to 400 A**

**Time-current curve - Size 3, 315 A to 400 A**

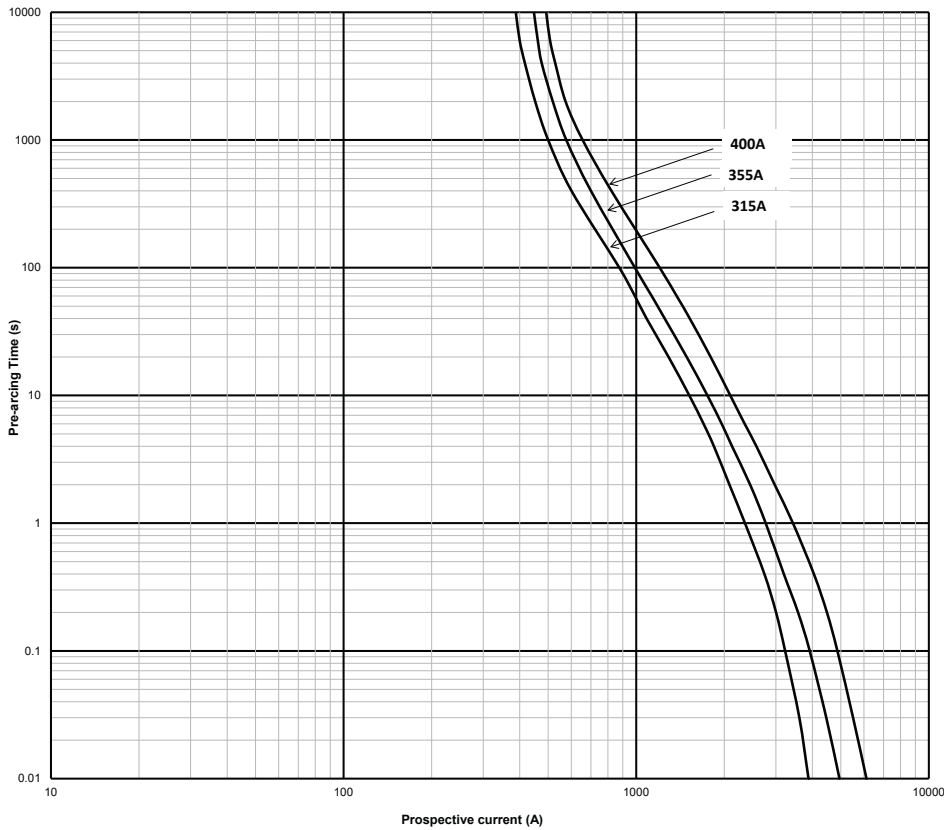

**Temperature derating**

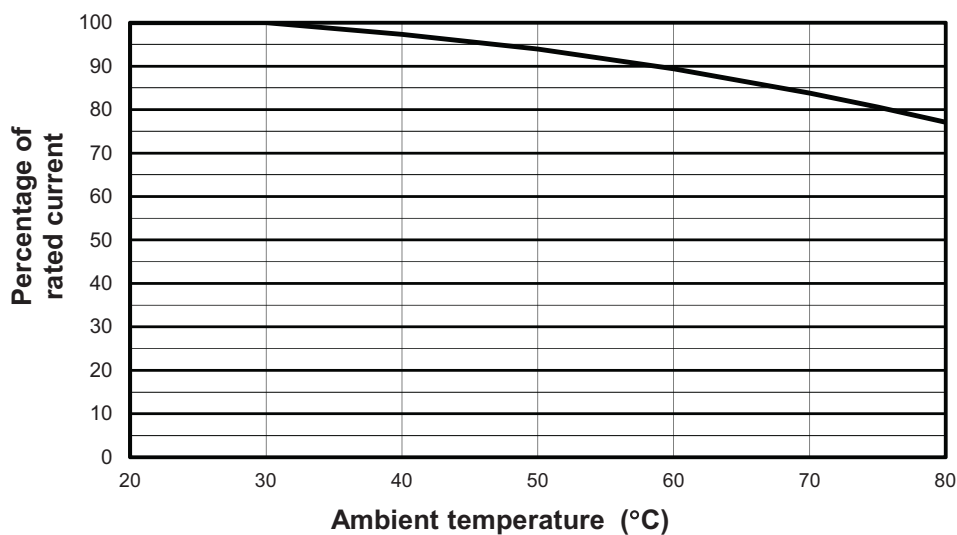

(The ambient temperature is that local to the fuse link)

# Battery storage fuse links

## BSF-3XL - XL Style, 1500 V d.c. (IEC/UL), 250 A to 500 A

### Specifications

#### Description

Eaton's Bussmann series XL battery storage fuses are specifically designed to protect and isolate battery array combiners and disconnects. These fuse links are capable of interrupting low overcurrents associated with faulted battery storage systems (reverse current, multi-array fault).

#### Technical data

- Rated voltage: 1500 V d.c.
- Rated current: 250 A to 500 A
- Operating class: gBat proposed for full range fuse links for protection of battery storage systems
- Breaking capacity: 100 kA
- Time constant: 4.5 ms at 100 kA

#### Microswitches

- For bladed fuse links
  - 170H0236
  - 170H0238
- For bolted fuse links
  - 170H0069

#### Compatible fuse bases

- SD3L-S-PV

#### Standards / Agency information

IEC 60269-7 for battery storage fuse links is under preparation.



#### Catalogue numbers

Fuse link body size	Rated voltage	Rated current (Amps)	I <sup>2</sup> t (A <sup>2</sup> Sec)		Watts loss (W)		Catalogue numbers	
			Pre-arcing	Total at 1500 V d.c.	0.7 I <sub>n</sub>	I <sub>n</sub>	Bladed version	Bolted version
3	1500 V d.c.	250	74,000	263,000	20	49	BSF-250G-3XL15	BSF-250G-3XL15-B
		315	150,000	533,000	21	52	BSF-315G-3XL15	BSF-315G-3XL15-B
		355	195,000	693,000	24	59	BSF-355G-3XL15	BSF-355G-3XL15-B
		400	296,000	1,060,000	24	61	BSF-400G-3XL15	BSF-400G-3XL15-B
		450	412,000	1,470,000	27	67	BSF-450G-3XL15	BSF-450G-3XL15-B
		500	532,000	1,890,000	29	73	BSF-500G-3XL15	BSF-500G-3XL15-B

**BSF-3XL - XL Style, 1500 V d.c. (IEC/UL), 250 A to 500 A**

**Dimensions (mm) - Size 3, bladed**

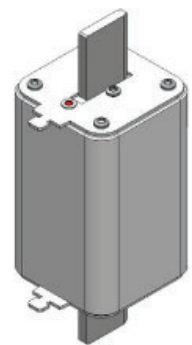
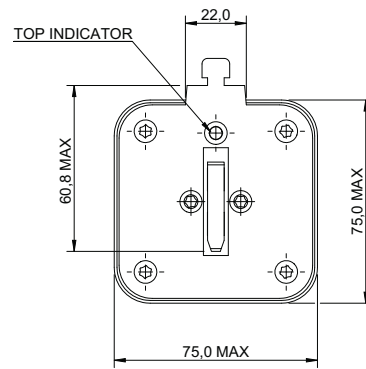
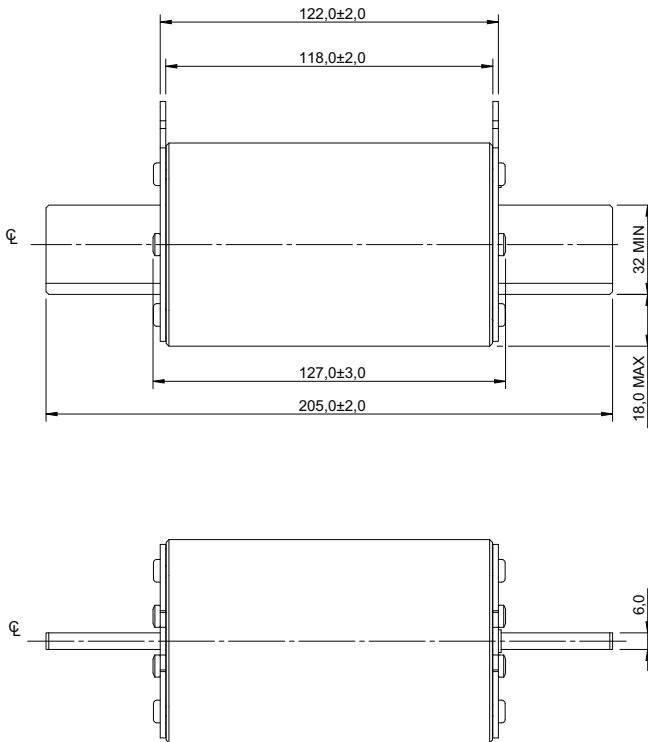

**Dimensions (mm) - Size 3, bolted**

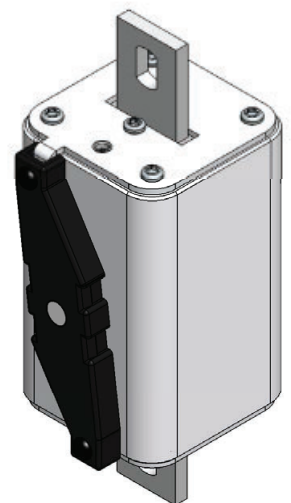
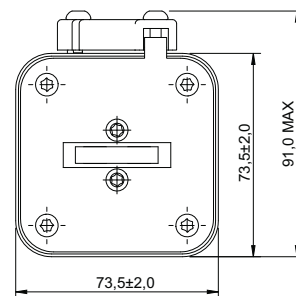
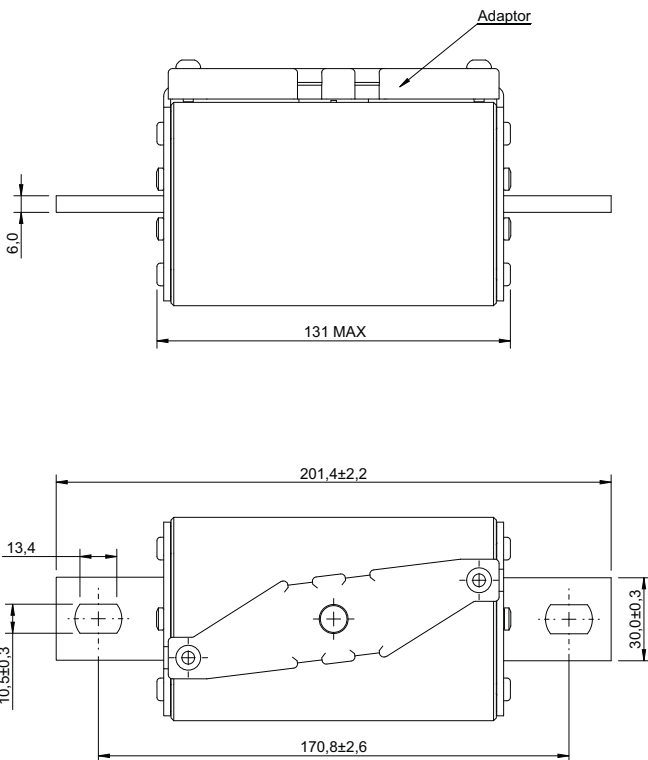

# Battery storage fuse links

## BSF-3XL - XL Style, 1500 V d.c. (IEC/UL), 250 A to 500 A

### Time-current curve - Size 3, 250 A to 500 A

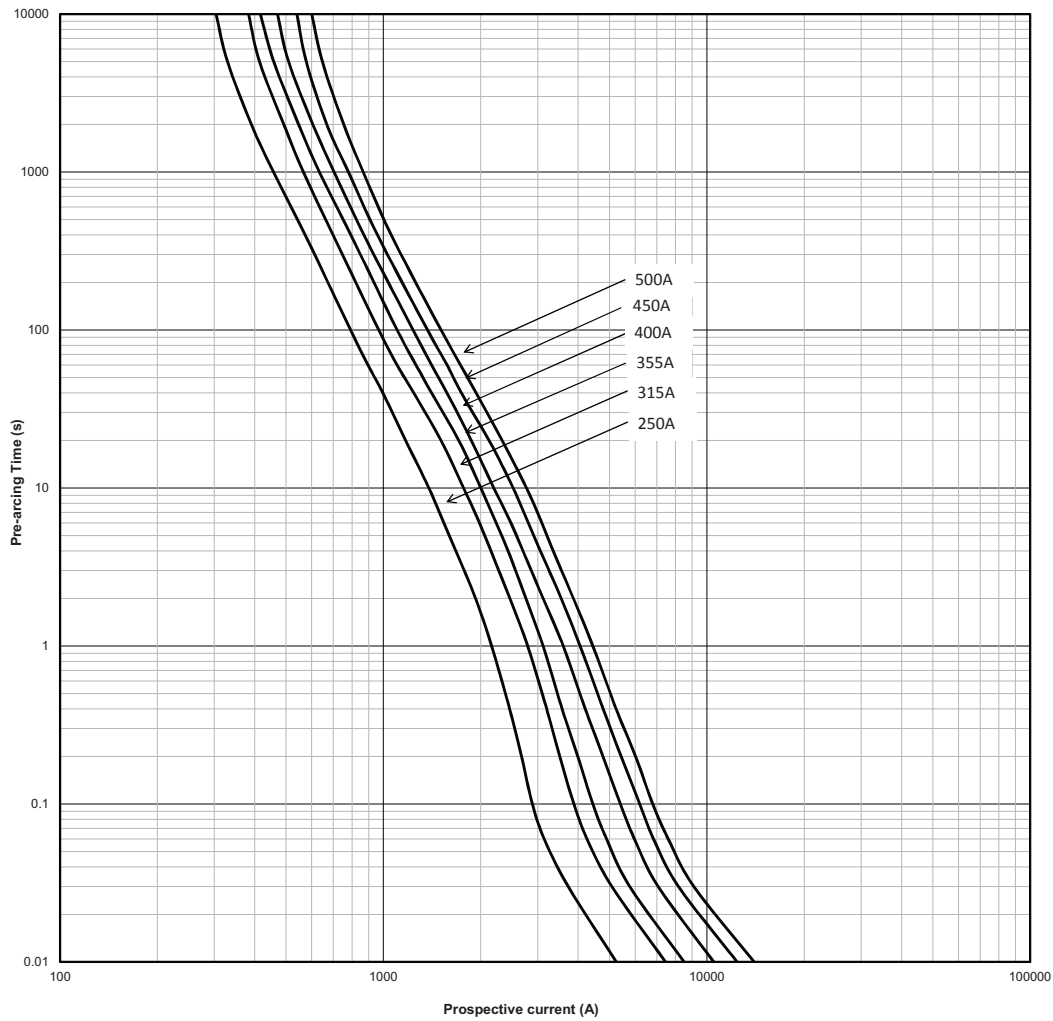

### Temperature derating

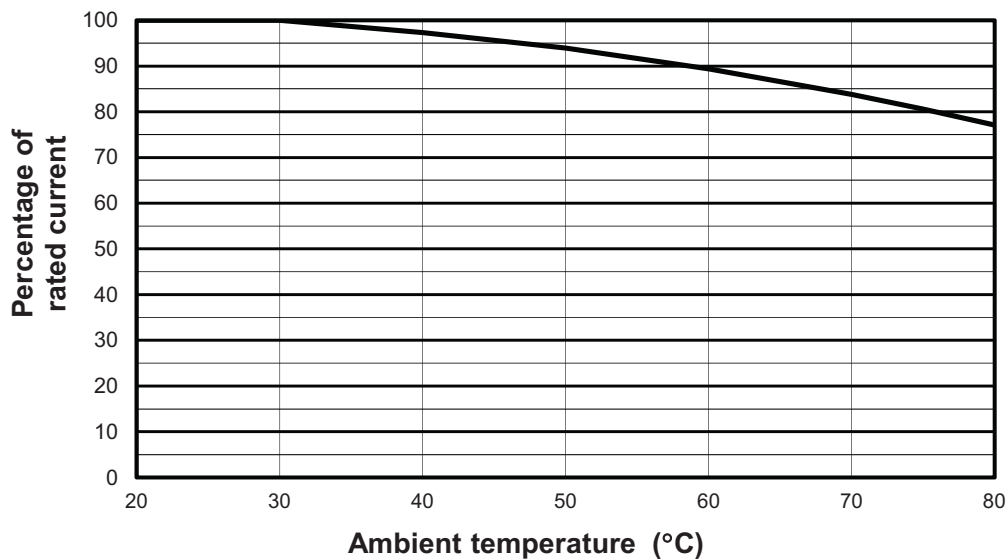



## Modular style fuse bases for North American, British and square body fuse links

### Description

Eaton's Bussmann series offers a comprehensive line of fuse bases that provide the user with design and manufacturing flexibility. Two identical half bases make up a Bussmann series modular fuse base. These 'split' units can be panel mounted any distance apart to accommodate any length fuse.

#### 1 - Stud type

The simpler design is the C5268 modular fuse base. With this design, the fuse terminal and cable (with termination) are mounted on the same stud, minimizing labor needed for installation. The stud type base is available in the configurations shown in the table below.

Catalogue numbers	Max fuse amp rating	Stud height (in)	Stud dia. & threads
C5268-1	200	1	5/16"-18
C5268-2	200	1.75	5/16"-18
C5268-3	200	0.75	5/16"-18
C5268-4	100	1	1/4"-20
C5268-5	100	1.75	1/4"-20

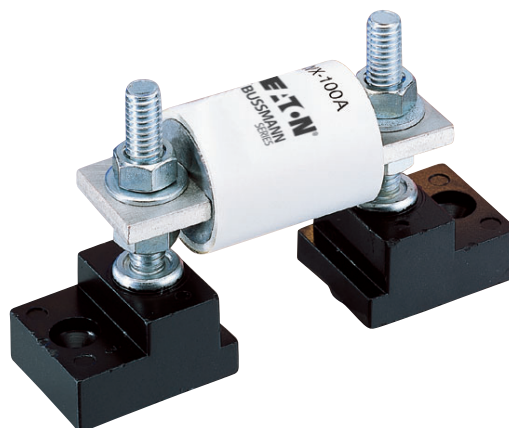

#### 2 - Connector Type

Eaton's Bussmann series also offers a modular style fuse base that utilizes a tin-plated connector for wire termination and heat dissipation) and a plated-steel stud (for fuse mounting). The connector type fuse base is available in the configurations shown below. Consult Eaton for additional product details.

Catalogue numbers	Max rated voltage	Max fuse Amp rating
1BS101	600	100
1BS102	600	400
1BS103	600	400
1BS104	600	600

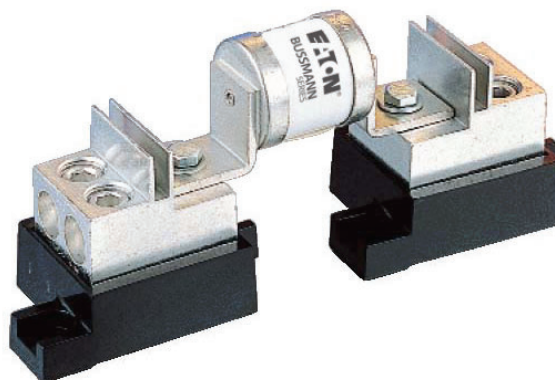

#### 3 - BH

BH fuse blocks provide a wide range of mounting configurations for Bussmann High Speed semi-conductors fuse links. BH fuse blocks have a Short-Circuit rated current rating of any installed fuse up to 200 kA RMS Sym.

Catalogue numbers	Max rated voltage	Max fuse Amp rating
BH-0	700	100
BH-1	2500	400
BH-2	5000	600
BH-3	1250	700

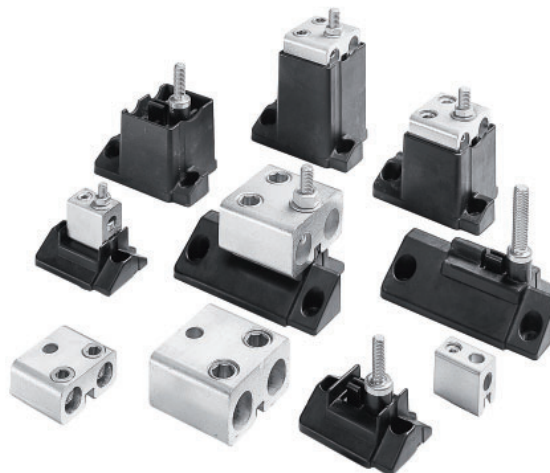

Data sheets: 1200 (BH-0), 1201 (BH-1), 1202 (BH-2), 1203 (BH-3), 1206 (1BS101), 1207 (1BS102), 1208 (1BS103), 1209 (1BS104)

## Fixed center fuse bases for DIN 43653 square body fuse links

### Description

Fuse bases (blocks) to be used with DIN 43653 square body fuse links with centre distances of 80 and 110mm. Available for sizes 000, 00, 1\*, 1, 2 and 3.

### Sizes 000 to 00 Fuse bases

Catalogue numbers	Max rated voltage (Volts)	Max fuse Amp rating (Amps)	Centre distance (mm)	Fuse sizes
170H1007	1000	400	80	00, 000
170H1013	690	200	80	0000, 000

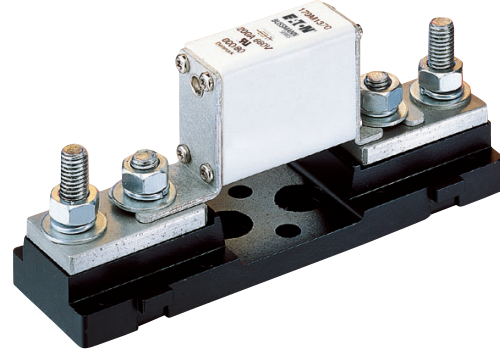

### Dimensions (mm) - 170H1007

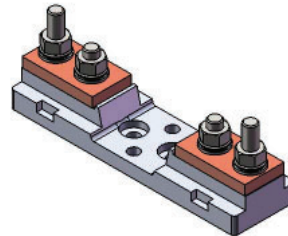
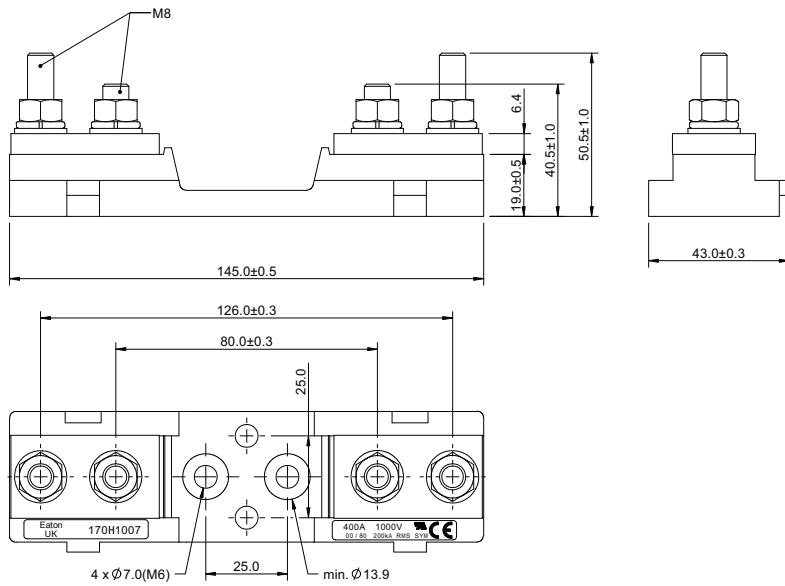

### Dimensions (mm) - 170H1013

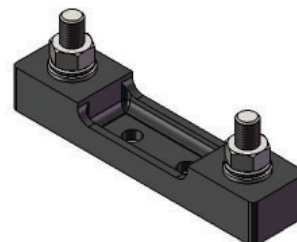
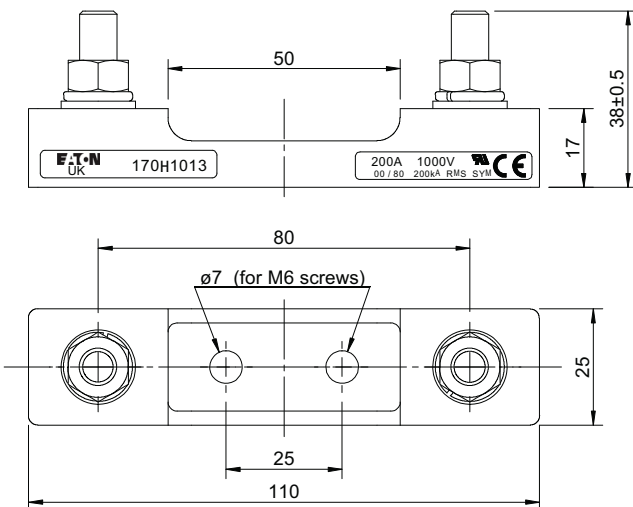

## Fixed center fuse bases for DIN 43653 square body fuse links

Sizes 1\* to 3

Catalogue numbers	Max rated voltage (Volts)	Max fuse Amp rating (Amps)	Centre distance (mm)
170H3003	1000 V a.c./V d.c.	630	80
170H3004	1000 V a.c./V d.c.	1250	80
170H3005	1400 V a.c./V d.c.	630	110
170H3006	1400 V a.c./V d.c.	1250	110



### Dimensions (mm) - 170H3003

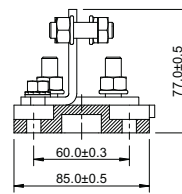
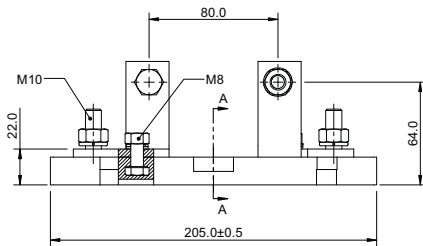

SECTION A-A

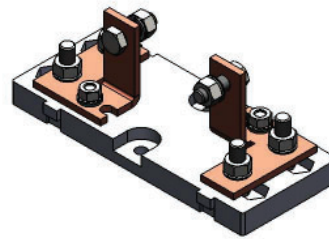
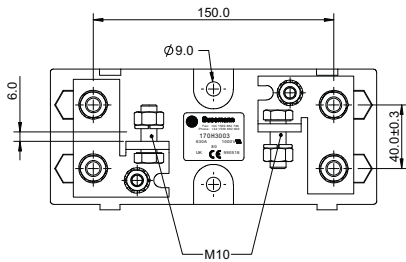

### Dimensions (mm) - 170H3004

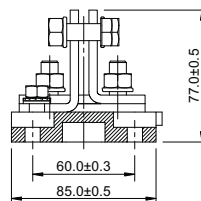
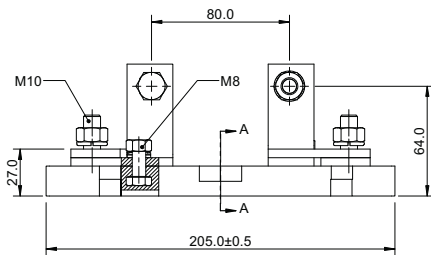

SECTION A-A

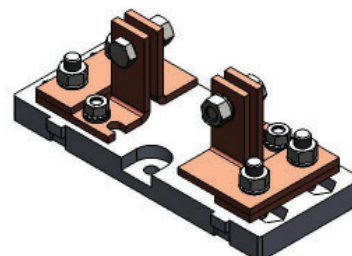
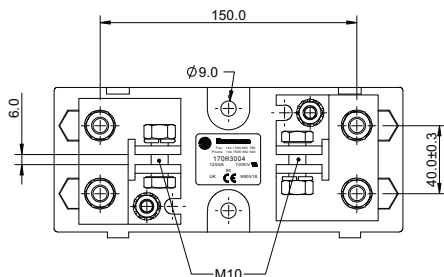

## Fixed center fuse bases for DIN 43653 square body fuse links

### Dimensions (mm) - 170H3005

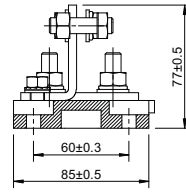
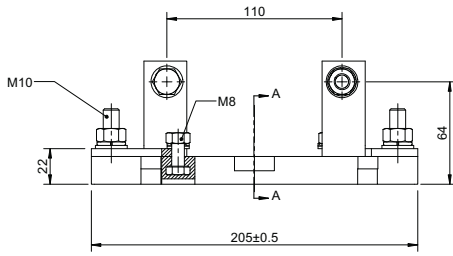

SECTION A-A

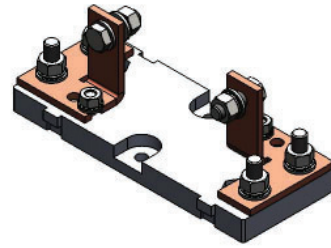
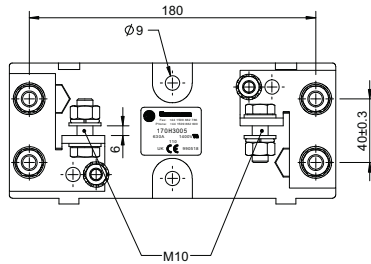

### Dimensions (mm) - 170H3006

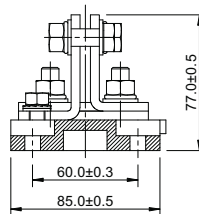
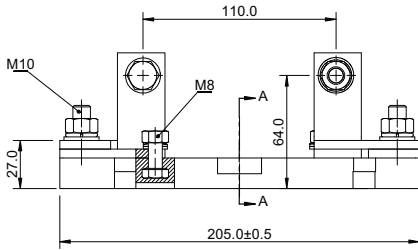

SECTION A-A

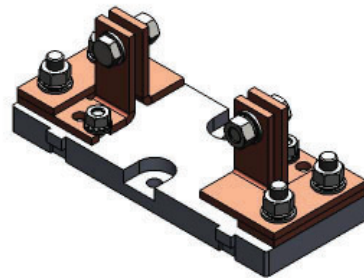
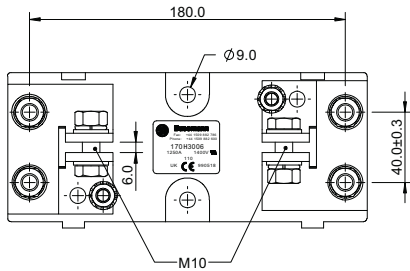

Fuse links with higher current ratings than 1250 A can be used with 170H3004 or 170H3006 if the maximum load current is derated according to the table below.

Fuse amp rating	Max. Amp load in fuse base
1400	1325
1500	1400
1600	1500
1800	1650
2000	1800

## BMM - Fuse bases for ferrule fuse links, 600 V a.c. (UL), 30 A

### Specifications

#### Description

Modular, open-style fuse blocks for cylindrical industrial fuse links. Versatile 35mm DIN rail or screw-to-panel mounting.

#### Technical data

- Rated voltage: 600 V a.c. (UL)
- Rated current:
  - 30 A (box lug terminal)
  - 20 A (with quick connector terminal)
- Compatible fuse links:
  - FWA-A10F
  - FWC-A10F
  - PVM
  - PV-A10F

#### Standards / Agency information

- UL Recognised E14853-IZLT2
- CSA Certified 47235-6225-01
- CE
- RoHS compliant
- Conflict mineral free
- Reach declaration available upon request



### Catalogue numbers

Terminal type				
Screw w/quick connect <sup>1</sup>	Pressure plate w/quick connect <sup>1</sup>	Box lug	Fuse link size	Number of poles
BMM603-1SQ	BMM603-1PQ	BMM603-1C	10 x 38 (13/32" x 1-1/2")	1
BMM603-2SQ	BMM603-2PQ	BMM603-2C	10 x 38 (13/32" x 1-1/2")	2
BMM603-3SQ	BMM603-3PQ	BMM603-3C	10 x 38 (13/32" x 1-1/2")	3

<sup>1</sup> Quick connect terminals rated for 20 A maximum.

# Accessories

## BMM - Fuse bases for ferrule fuse links, 600 V a.c. (UL), 30 A

Dimensions mm (in)

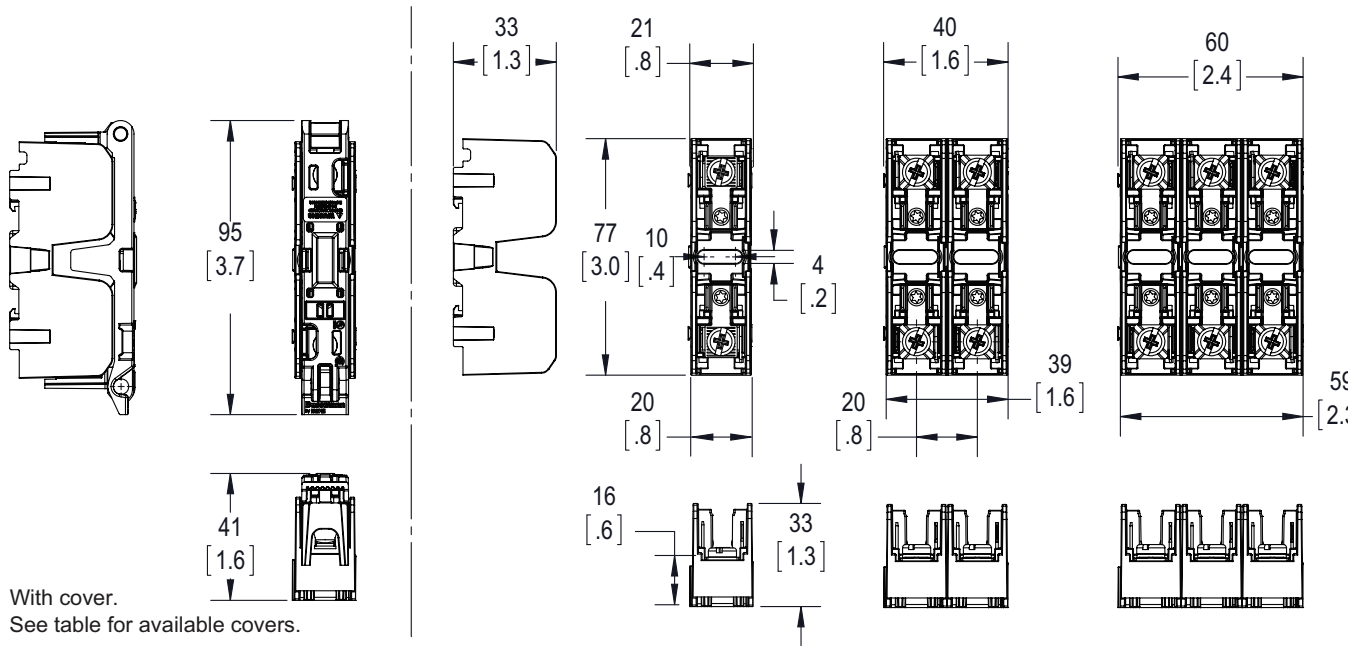

### Recommended covers

Terminal type	Cover part numbers	
	Indicating	Non indicating
Box lug (CR)	CVRI-CCM	CVR-CCM
Screw/quick connect (SQ)	CVRI-CCM-QC	CVR-CCM-QC
Pressure plate/quick connect (PQ)	CVRI-CCM-QC	CVR-CCM-QC

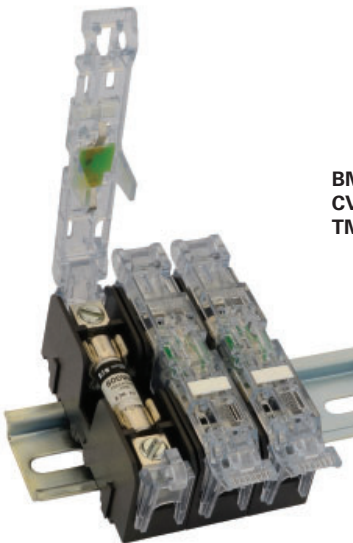

**BMM603-3C with  
CVRI-CCM covers and  
TM27CB marker labels**

# JM70100 - Fuse bases for ferrule fuse links, 700 V a.c. (UL), 100 A

## Specifications

### Description

Modular, open-style fuse blocks for cylindrical industrial fuse links. Versatile 35mm DIN rail or screw-to-panel mounting.

### Technical data

- Rated voltage: 700 V a.c. (UL)
- Rated current: 100 A
- Compatible fuse links: FWP-A22F(I)

### Standards / Agency information

UL Recognised, Guide IZTL2, File 14853.

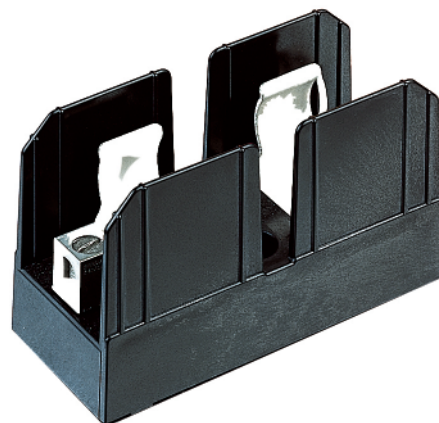

## Catalogue numbers

Terminal type		
Box lug with retaining clip	Fuse link size	Number of poles
JM70100-1CR		1
JM70100-2CR	22 x 58 mm	2
JM70100-3CR		3

## Dimensions mm (in)

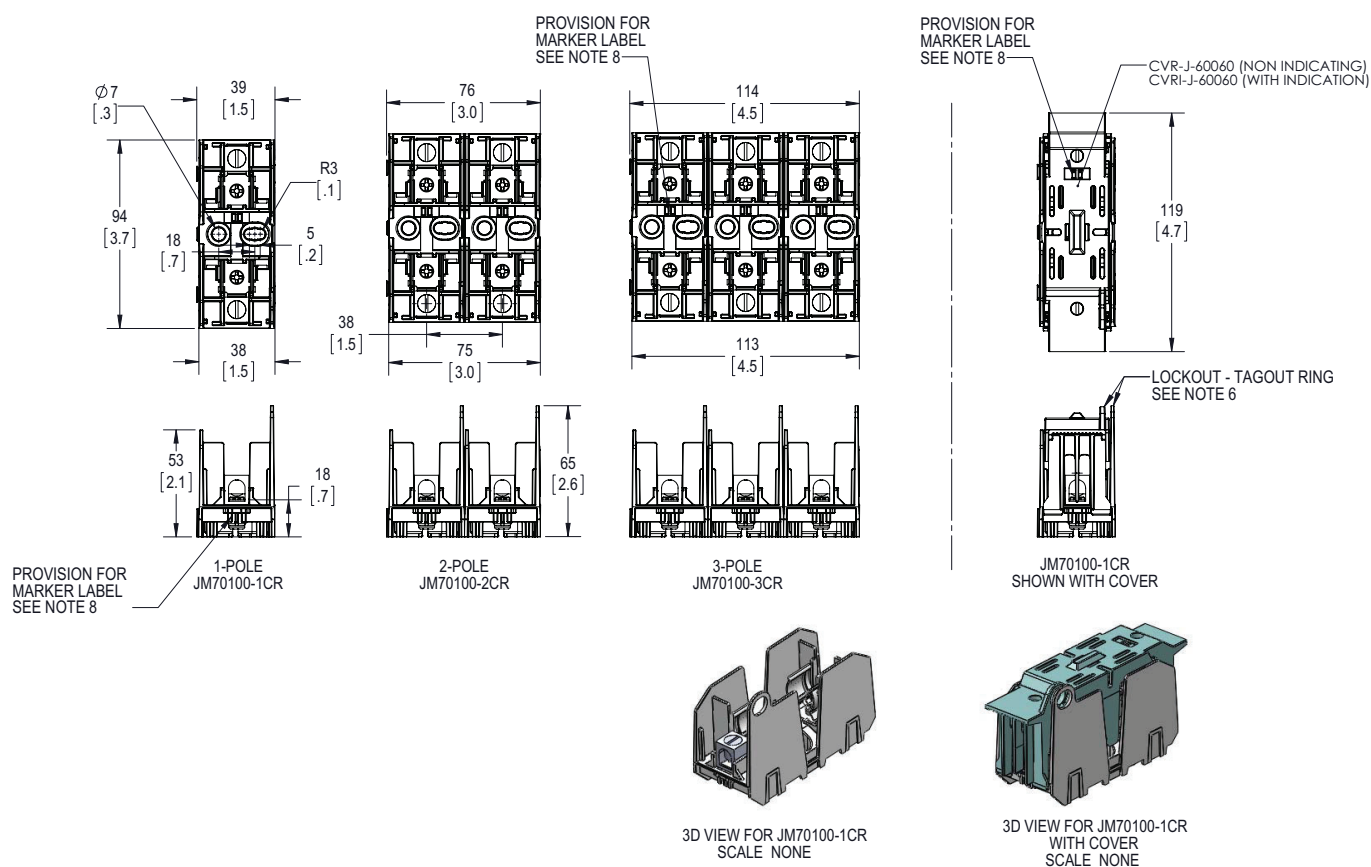

## JM60 - Modular knifeblade fuse blocks, 600 V a.c. (UL), 70 A to 600 A

### Specifications

#### Description

Industry's first modular fuse block simplifies design and enhances safety.

#### Technical data

- Rated voltage: 600V a.c. (UL)
- Rated current: see table below
- Compatible fuse links: DFJ



#### Standards / Agency information

##### Blocks

- UL - Listed cULus E14853 - IZLT & IZLT7
- CSA - Certified 47235-6225-01

##### Covers

- UL - Listed UL E58836 - JDVS2
- CSA - Certified 47235-6225-01

#### Catalogue numbers

Class J Block	Covers without indication*	Covers with indication*	Rated voltage	Rated current (Amps)	Number of poles	Compatible Bussmann series fuse links
JM60100-1CR					1	
JM60100-2CR	CVR-J-60100	CVRI-J-60100	600 V a.c.	70-100	2	
JM60100-3CR					3	
JM60200-1CR					1	
JM60200-2CR	CVR-J-60200	CVRI-J-60200	600 V a.c.	110-200	2	
JM60200-3CR					3	
JM60400-1CR					1	DFJ
JM60400-2CR	CVR-J-60400-M	CVRI-J-60400-M	600 V a.c.	225-400	2	
JM60400-3CR					3	
JM60600-1CR					1	
JM60600-2CR	CVR-J-60600	CVRI-J-60600	600 V a.c.	450-600	2	
JM60600-3CR					3	

\* Covers sold separately. Blown fuse indication requires 90 volts minimum and closed circuit to operate.

#### Wire range and torque values

Catalogue numbers	Wire range (solid and stranded)	Wire range (fine stranded)	Torque N•m (Lb-in)
JM60100-1CR	1/0-3 AWG; (2) Cu 4-6 AWG	1-3 AWG	6.2 (55)
JM60100-2CR	4-6 AWG; (2) Cu 8 AWG	4-6 AWG	5.6 (50)
JM60100-3CR	8 AWG; (2) Cu 10-14 AWG Cu 10-14 AWG; Al 10-12 AWG	8 AWG	5.1 (45) 4.5 (40) 4.0 (35)
JM60200-1CR			
JM60200-2CR	250 MCM -1 AWG	3/0-1 AWG	42 (375)
JM60200-3CR	2-6 AWG; (2) Cu 2-6 AWG	2-6 AWG	31 (275)
JM60400-1CR			
JM60400-2CR	600kcmil		57 (500)
JM60400-3CR	500kcmil-4 AWG (2) Cu 3/0 - 4 AWG (2) Al 3/0 - 4 AWG	N/A	51 (450) 57 (500) 34 (300)
JM60600-1CR			
JM60600-2CR	(2) 500kcmil-4 AWG	N/A	51 (450)



## JM60 - Modular knifeblade fuse blocks, 600 V a.c. (UL), 70 A to 600 A

### Dimensions mm (in) - 100 A

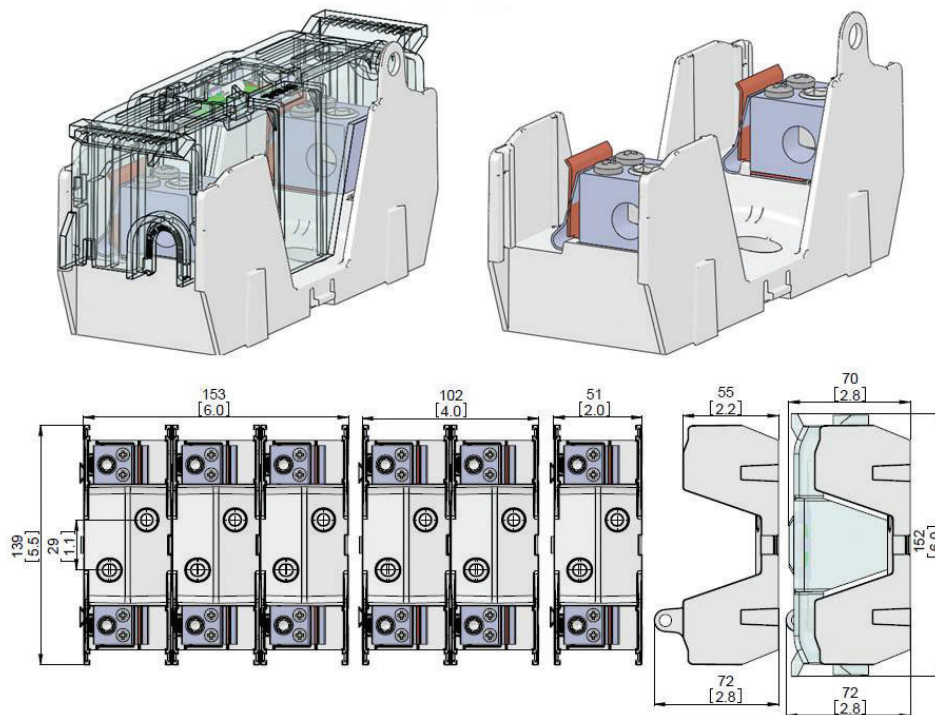

### Dimensions mm (in) - 200 A

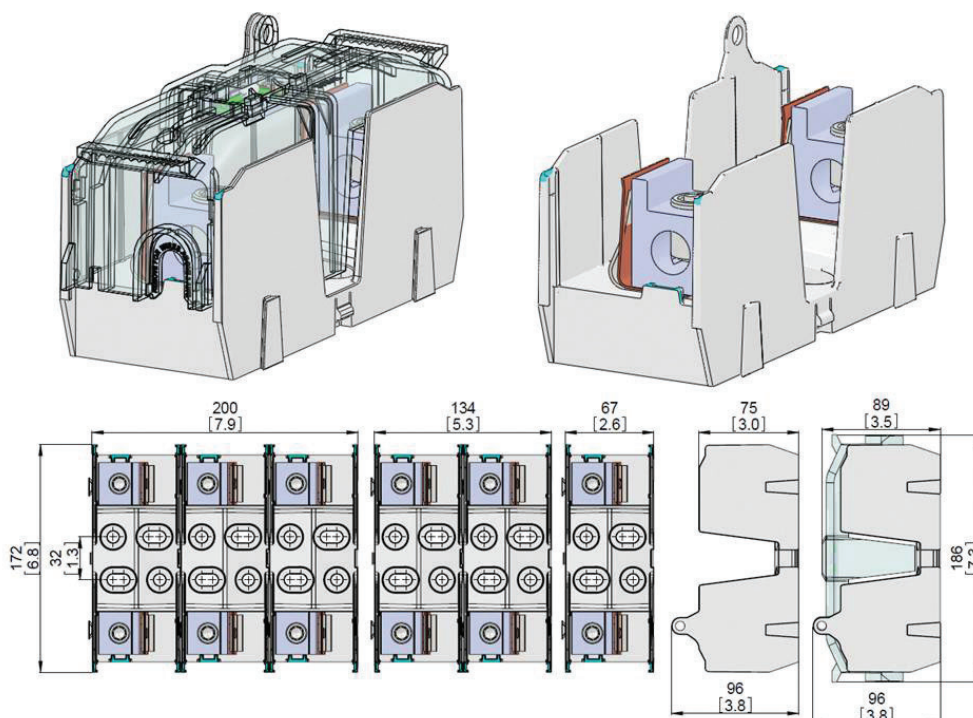

# Accessories

## JM60 - Modular knifeblade fuse blocks, 600 V a.c. (UL), 70 A to 600 A

### Dimensions mm (in) - 400 A

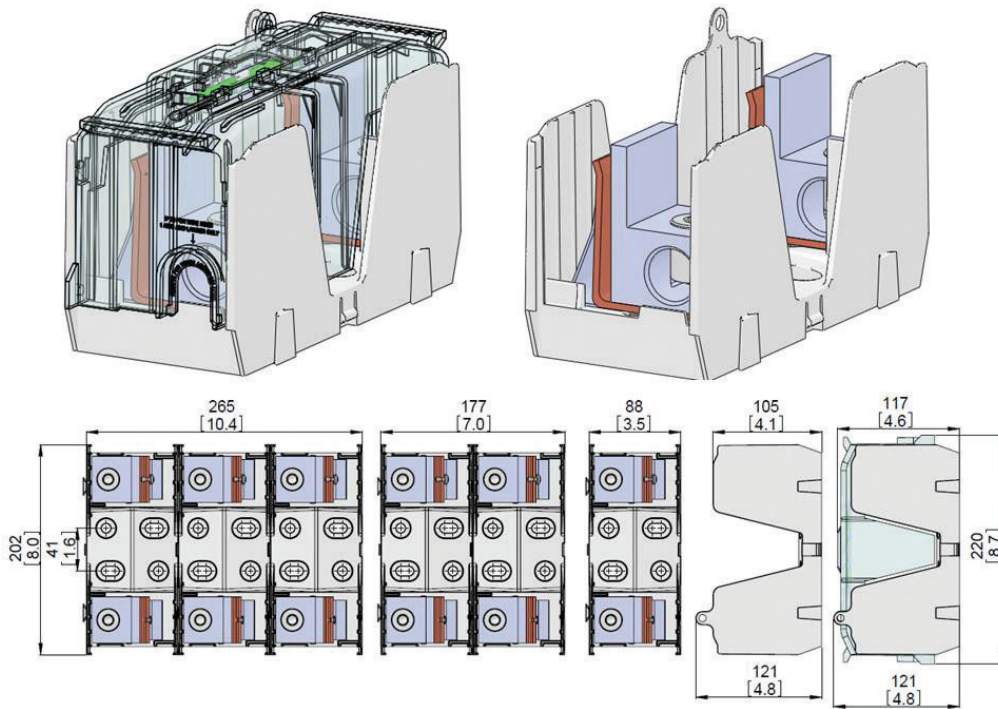

### Dimensions mm (in) - 600 A

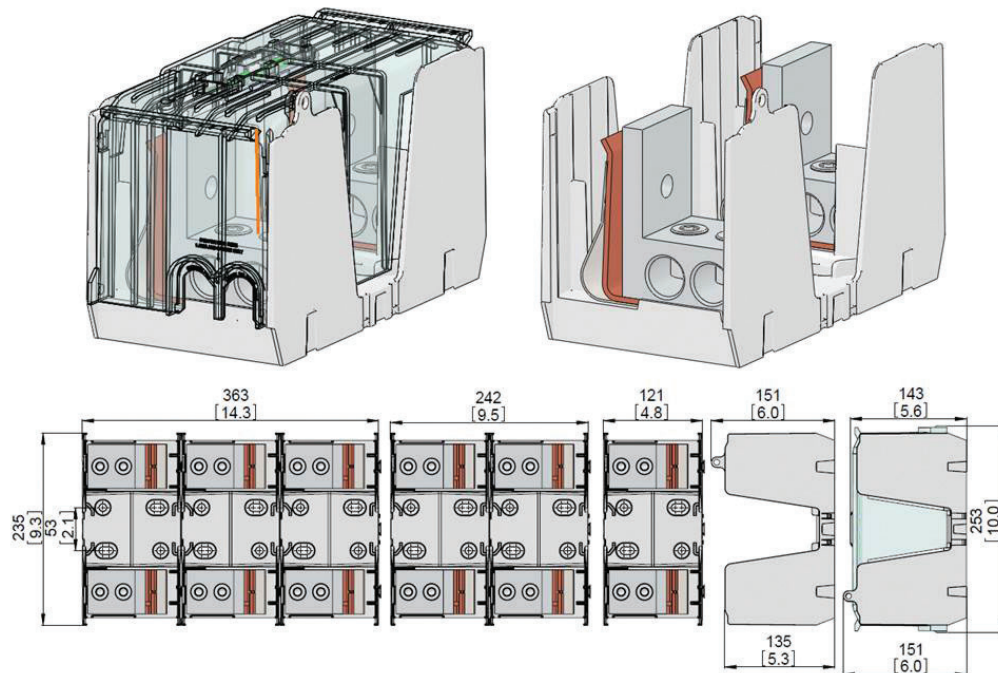

## CHM - Modular fuse holders for 10 x 38 mm fuse links

### Specifications

#### Description

Compact DIN-Rail mounting fuse holders for 10 x 38 mm cylindrical fuse links

#### Technical data

See table page 384

#### Catalogue numbers

Catalogue number	Number of poles	Description
<b>Modular fuse holders for IEC industrial applications (Red)</b>		
<b>Neutral only</b>		
CHM1DNXU	1	Neutral fuse holder
<b>Fuse holder only</b>		
CHM1DU	1	1-pole modular fuse holder
CHM2DU	2	2-pole modular fuse holder
CHM3DU	3	3-pole modular fuse holder
CHM4DU	4	4-pole modular fuse holder
<b>Fuse holder and neutral</b>		
CHM1DNU	2	1-pole + neutral modular fuse holder
CHM3DNU	4	3-pole + neutral modular fuse holder
<b>Fuse holder with neon indicator</b>		
CHM1DIU	1	1-pole modular fuse holder with neon indicator
CHM2DIU	2	2-pole modular fuse holder with neon indicator
CHM3DIU	3	3-pole modular fuse holder with neon indicator
CHM4DIU	4	4-pole modular fuse holder with neon indicator
<b>Fuse holder with neon indicator and neutral</b>		
CHM1DNUIU	2	1-pole + neutral modular fuse holder with neon indicator
CHM3DNUIU	4	3-pole + neutral modular fuse holder with neon indicator
<b>Fuse holder with LED Indicator</b>		
CHM1DI-48U	1	1-pole modular fuse holder with LED indicator
<b>Modular fuse holders for photovoltaic applications (Yellow)</b>		
<b>Fuse holder only</b>		
CHPV1U	1	1-pole modular fuse holder
CHPV2U	2	2-pole modular fuse holder holder
<b>Fuse holder with neon indicator</b>		
CHPV1IU	1	1-pole modular fuse holder with neon indicator
CHPV2IU	2	2-pole modular fuse holder with neon indicator
<b>Modular fuse holders for UL Class CC applications (Black)</b>		
<b>Fuse holder only</b>		
CHCC1DU	1	1-pole modular fuse holder
CHCC2DU	2	2-pole modular fuse holder
CHCC3DU	3	3-pole modular fuse holder
<b>Fuse holder with neon indicator</b>		
CHCC1DIU	1	1-pole modular fuse holder with neon indicator
CHCC2DIU	2	2-pole modular fuse holder with neon indicator
CHCC3DIU	3	3-pole modular fuse holder with neon indicator
<b>Fuse holder with LED Indicator</b>		
CHCC1DI-48U	1	1-pole modular fuse holder with LED indicator



## CHM - Modular fuse holders for 10 x 38 mm fuse links

### Technical data

Type	Rated voltage		Rated current		Terminal rating	Rated breaking withstand capacity	Compatible Bussmann series fuse links
	IEC	UL	IEC	UL			
<b>Modular fuse holders for IEC industrial applications (Red)</b>							
CHM1	690 V a.c.	600 V a.c.	32 A	30 A	IEC 1 to 25 mm <sup>2</sup> 70°C PVC Copper cable (solid stranded or fine stranded) Spade lug Comb bus bar	IEC 120 kA rms sym  UL 200 kA rms sym  CCC 100 kA rms sym	IEC: C10 and FWP-G10F  UL: FNQ, KLM, FNM, KTK, BAF, FWA, PVM, AGU, BAN, FWC
CHM_DN(X)U	690 V a.c.	600 V a.c.	32 A	30 A			
CHM1DI-48U	48 V d.c.	48 V d.c.	32 A	30 A			
<b>Modular fuse holders for Photovoltaic applications (Yellow)</b>							
CHPV	1000 V d.c.	1000 V d.c.	32 A	30 A	IEC 1 to 25 mm <sup>2</sup> 70°C PVC Copper cable (solid stranded or fine stranded) Spade lug Comb bus bar	33 kA rms sym	Solar PV range: PVM, PV-A10F
<b>Modular fuse holders for UL Class CC Industrial applications (Black)</b>							
CHCC	N/A	600 V a.c.	N/A	30 A	Cable 75°C and 90°C Cu cable	200 kA rms sym	LP-CC, FNQ-R, KTK-R
CHCC1DI-48U	N/A	48 V d.c.	N/A	30 A			

### Standards / Agency information

	IEC	UL	CSA	CCC	CE
CHMD(I)U	IEC 60269-1 IEC 60269-2	UL 4248-1 UL file E14853	C22.2 No 4248.1	GB 13539.1 GB 13539.2	DCB 272
CHMDN(I)U	IEC 60269-1 IEC 60269-2	UL 4248-1 UL file E14853	C22.2 No 4248.1	GB 13539.1 GB 13539.2	DCB 272
CHM1DI-48U	IEC 60269-1 IEC 60269-2	UL 4248-1 UL file E14853	C22.2 No 4248.1	GB 13539.1 GB 13539.2	DCB 272
CHM1DNXU	IEC 60269-1 IEC 60269-2	UL 4248-1 UL file E14853	C22.2 No 4248.1	GB 13539.1 GB 13539.2	DCB 272
CHPV	IEC 60269-1	UL 4248-1 UL4248-19 UL file E14853	C22.2 No 4248.1 C22.2 No 4248.19	GB 13539.1	DCB 272
CHCC1D(I) to CHCC3D(I)U	N/A	UL 4248-1 UL file E14853	C22.2 No 4248.1	N/A	Contact: fusetech@eaton.com
CHCC1DI-48U	N/A	UL 4248-1 UL file E14853	C22.2 No 4248.1	N/A	Contact: fusetech@eaton.com

### Dimensions mm (in)

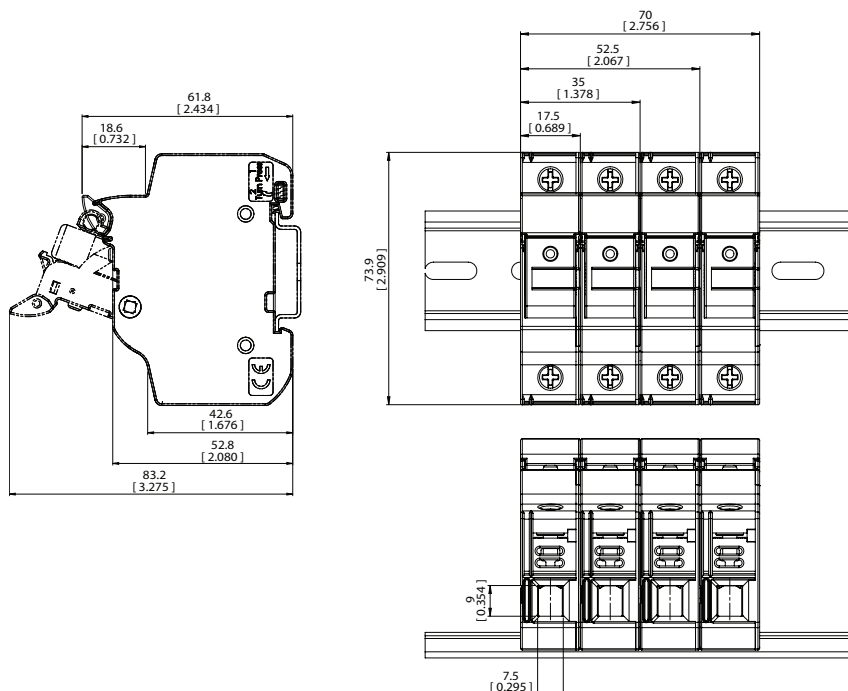

Data sheet: 720147

## CH14 - Modular fuse holders for 14 x 51 mm fuse links, 690 V a.c. / 750 and 1500V d.c., 50 A

### Specifications

#### Description

Compact DIN-Rail mount fuse holders for 14 x 51 mm cylindrical fuse links. Available in different versions with neutral and microswitch.

#### Technical data

Rated voltage & Rated current: see table page 390

#### Compatible fuse links

- C14G and C14M14 x 51 mm gG and gM cylindrical fuse links
- FW Ferrule
  - FWH-A14F
  - FWX-A14F
  - FWP-A14F (please consult Eaton's [bulehighspeedtechnical@eaton.com](mailto:bulehighspeedtechnical@eaton.com) if you wish to use a FWP fuse link with a striker option)
  - FWP-G14F
- PV-A14F



#### Standards / Agency information

IEC 60269-1 and 60269-2

#### Catalogue numbers

Catalogue number	Number of poles	Description
<b>Neutral only</b>		
CH141DNXU	1	Neutral modular fuse fuse holder
<b>Fuse holder only</b>		
CH141DU	1	1-pole modular fuse holder
CH142DU	2	2-pole modular fuse holder
CH143DU	3	3-pole modular fuse holder
CH144DU	4	4-pole modular fuse holder
<b>Fuse holder and neutral</b>		
CH141DNU	2	1-pole + neutral modular fuse holder
CH143DNU	4	2-pole + neutral modular fuse holder
<b>Fuse holder with neon indicator</b>		
CH141DIU	1	1-pole modular fuse holder with neon indicator
CH142DIU	2	2-pole modular fuse holder with neon indicator
CH143DIU	3	3-pole modular fuse holder with neon indicator
CH144DIU	4	4-pole modular fuse holder with neon indicator
<b>Fuse holder with neon indicator and neutral</b>		
CH141DNUI	2	1-pole + neutral modular fuse holder with neon indicator
CH143DNUI	4	3-pole + neutral modular fuse holder with neon indicator
<b>Fuse holder with microswitch</b>		
CH141DMSU-F	1	1-pole modular fuse holder with microswitch for remote fuse indication operation
CH143DMSU-F	3	3-pole modular fuse holder with microswitch for remote fuse indication operation
<b>Fuse holder with microswitch and neutral</b>		
CH143DNMSU-F	4	3-pole + neutral modular fuse holder with microswitch for remote fuse indication operation
<b>Fuse holder with LED Indicator</b>		
CHPV141DI-48U	1	1-pole modular fuse holder with LED indicator
<b>Fuse holder for photovoltaic applications</b>		
CHPV141U	1	1-pole modular fuse holder
CHPV141IU	1	1-pole modular fuse holder with neon indicator
CHPV142U	2	2-pole modular fuse holder holder
CHPV142IU	2	2-pole modular fuse holder with neon indicator

Data sheet: 10080

# Accessories

## CH14 - Modular fuse holders for 14 x 51 mm fuse links, 690 V a.c. / 750 and 1500V d.c., 50 A

### Technical data

Type	Rated current		Rated voltage		Agency markings	Terminal rating	Rated breaking withstand capacity	Compatible Bussmann series fuse links
	IEC	UL	IEC	UL				
CH14	50 A (a.c. and d.c.)	50 A	690 V a.c. / 750 V d.c.	700 V a.c.	IEC 60269-1 and 2 UL Listed file number E14853	Cable size: 1.5-50 mm <sup>2</sup> Recommended torque setting: 3.5 N•m Maximum torque setting: 3.5 N•m	120 kA a.c.	C14G and C14M FWX-A14F <sup>1</sup> FWH-A14F <sup>1</sup> FWP-A14F FWP-G14F
CHPV Photovoltaic	50 A (a.c. and d.c.)	50 A	1500 V d.c.	1500 V d.c.	IEC 60269-1 and 2 UL Listed file number E348242	Mounting 35 mm DIN-Rail or 2 x M4 panel mounting screws	10 kA d.c.	PV-A14F

<sup>1</sup> Maximum allowed continuous current applies. Please refer to data sheet for details.

### Accessories

Catalogue numbers	Description	Unit packing
JV-L	Multi-pole connector kit. One kit will gang up to 4-poles together	12
CH14-SPS	Microswitch to work on CH141D(I)U, 1 n/o + 1 n/c changeover type	3
CH14-TPS	Microswitch to work on CH143D(I)U, 1 n/o + 1 n/c changeover type	3
CH14-CTP	IP20 protection accessory, provides IP20 protection to terminals with 10mm <sup>2</sup> or less cable	12

### Dimensions (mm)

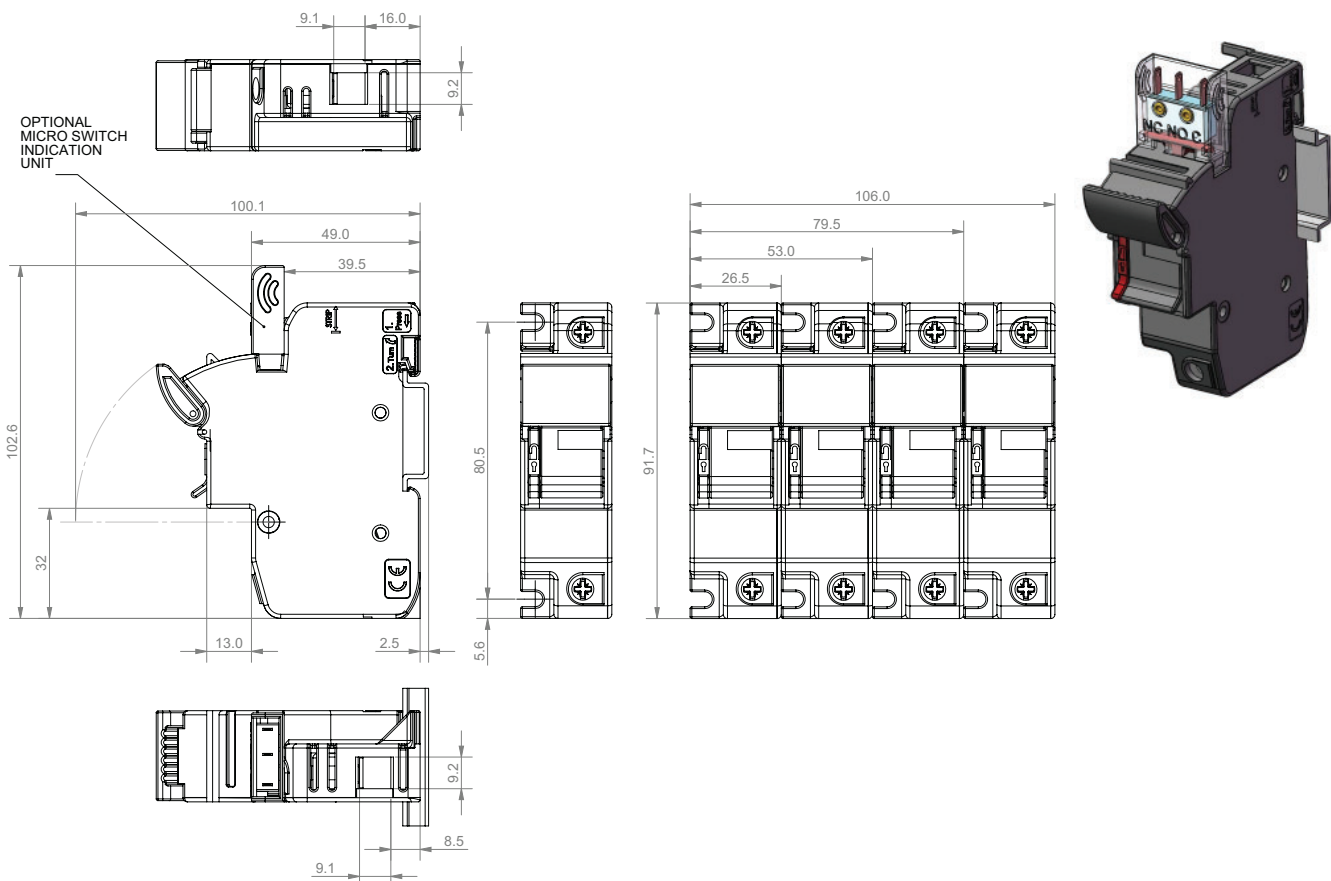

Data sheet: 10080

## CH22 - Modular fuse holders for 22 x 58 mm fuse links, 690 V a.c./1000 V d.c., 125 A

### Specifications

#### Description

Compact DIN-Rail mount fuse holders for 22 x 58 mm cylindrical fuse links. Available in different versions with neutral and microswitch.

#### Technical data

Rated voltage & Rated current: see table below

#### Compatible fuse links

- C22G and C22M 22 x 58 mm gG and gM cylindrical fuse links
- FWP-A22F Ferrule (please consult Eaton for derating information [bulehighspeedtechnical@eaton.com](mailto:bulehighspeedtechnical@eaton.com))
- FWP-G22F

#### Standards / Agency information

IEC 60269-1 and 60269-2



#### Catalogue numbers

Catalogue number	Number of poles	Description
<b>Neutral only</b>		
CH221DNXU	1	Neutral holder
<b>Fuse holder only</b>		
CH221DU	1	1-pole modular fuse holder
CH222DU	2	2-pole modular fuse holder
CH223DU	3	3-pole modular fuse holder
CH224DU	4	4-pole modular fuse holder
<b>Fuse holder with neon indicator</b>		
CH221DIU	1	1-pole modular fuse holder with neon indicator
CH222DIU	2	2-pole modular fuse holder with neon indicator
CH223DIU	3	3-pole modular fuse holder with neon indicator
CH224DIU	4	4-pole modular fuse holder with neon indicator
<b>Fuse holder and neutral</b>		
CH221DNU	2	1-pole + neutral modular fuse holder
CH223DNU	4	3-pole + neutral modular fuse holder
<b>Fuse holder with neutral and neon indicator</b>		
CH221DNUI	2	1-pole + neutral modular fuse holder + neon indicator
CH223DNUI	4	3-pole + neutral modular fuse holder + neon indicator
<b>Fuse holder with microswitch</b>		
CH221DMSU-F	1	1-pole modular fuse holder with microswitch (pre-breaking/fuse operation)
CH223DMSU-F	3	3-pole modular fuse holder with microswitch (pre-breaking/fuse operation)
<b>Fuse holder with neutral and microswitch</b>		
CH223DNMSU-F	3	3-pole modular fuse holder + neutral + microswitch (pre-breaking/fuse operation)
<b>Fuse holder with LED Indicator</b>		
CH221DI-48U	1	1-pole modular fuse holder with LED Indicator

#### Technical data

Rated voltage		Rated current		Agency markings	Terminal rating	Rated breaking withstand capacity	Compatible Bussmann series fuse links
IEC	UL	IEC	UL				
690 V a.c. 1000 V d.c.	700 V a.c.	125 A (a.c. and d.c.)	100 A (a.c.)	IEC 60269-1 and 2 UL Listed file number E14853	Cable size: 2.5-70 mm <sup>2</sup> Recommended torque setting: 4 N•m Maximum torque setting: 5 N•m Mounting 35 mm DIN-Rail or 2 x M4 panel mounting screws	120 kA a.c. 50 kA d.c.	FWP Ferrule <sup>1</sup>

<sup>1</sup> Maximum allowed continuous current applies. Please refer to data sheet for details.

Data sheet: 10115

## CH22 - Modular fuse holders for 22 x 58 mm fuse links, 690 V a.c./1000 V d.c., 125 A

### Accessories

Catalogue numbers	Description	Unit packing
JV-L	Multi-pole connector kit. One kit will gang up to 4-poles together	12
CH22-CTP	IP20 protection accessory, provides IP20 protection to terminals with 10mm <sup>2</sup> or less cable	12
CH22-SPS	Microswitch to work on CH221D(I)U, 1 n/o + 1 n/c changeover type	3
CH22-TPS	Microswitch to work on CH223D(I)U, 1 n/o + 1 n/c changeover type	3

### Dimensions (mm)

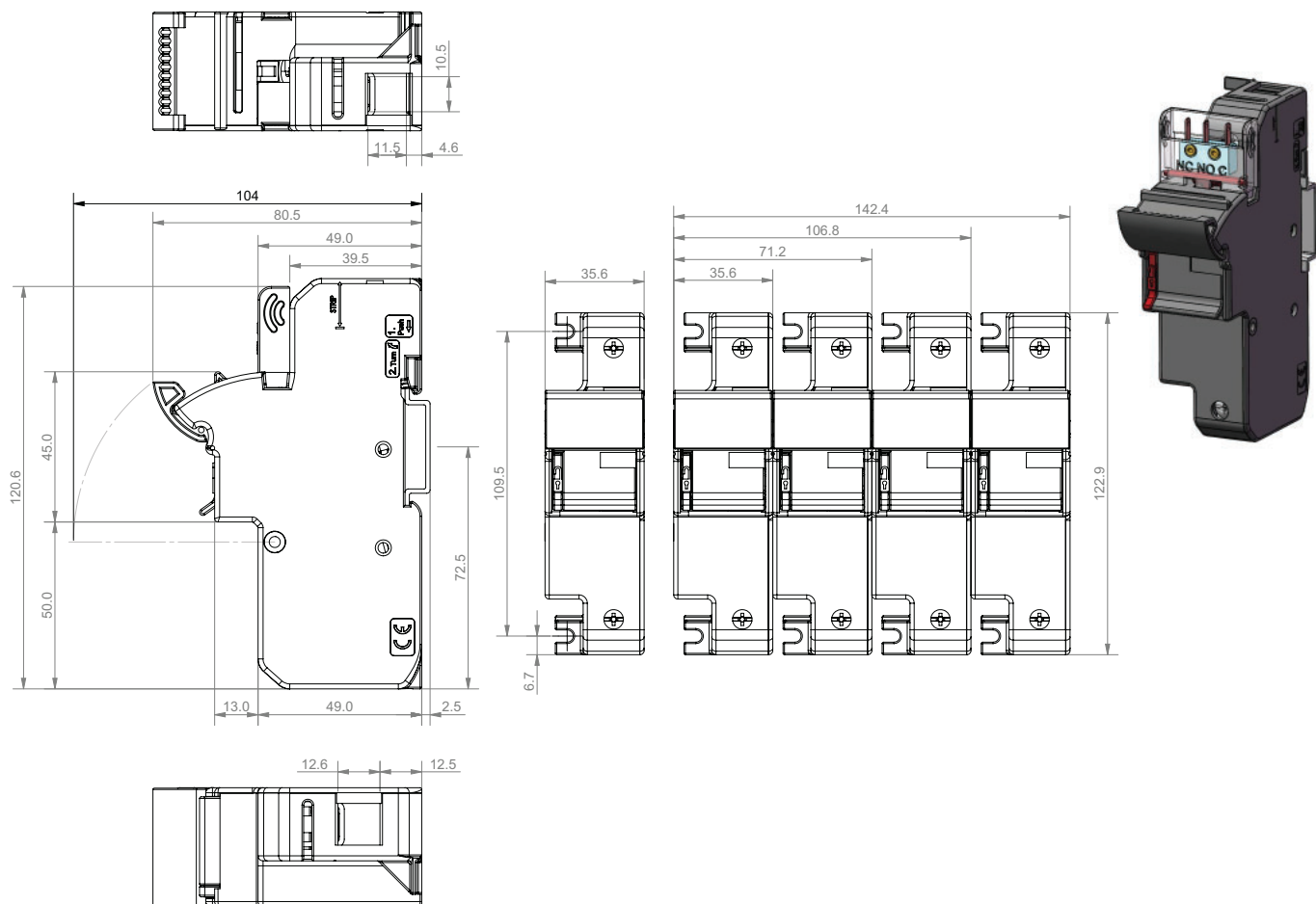



## 170H - Microswitches for square body fuse links - indicator systems

High Speed square body fuse links are available with three different indicators.

### 1 - Visual Indicator

The indicator situated in one end plate is clearly visible as soon as the fuse link has operated. The minimum rated voltage for operating the indicator is 20 V.

### 2 - Type T Indicator

The indicator is situated on one cover plate with a cover plate tag to accommodate an auxiliary switch. The minimum rated voltage for operating the indicator is 20 V. A special low rated voltage indicator (1.5V) is available on request.

### 3 - Type K Indicator

The indicator is situated on the fuse link body. It is covered by an adaptor for snap-on mounting of an auxiliary switch. The operating Rated voltage of the indicator is 1.5V. As a matter of safety, the factory mounted adaptor must not be removed from the fuse link.

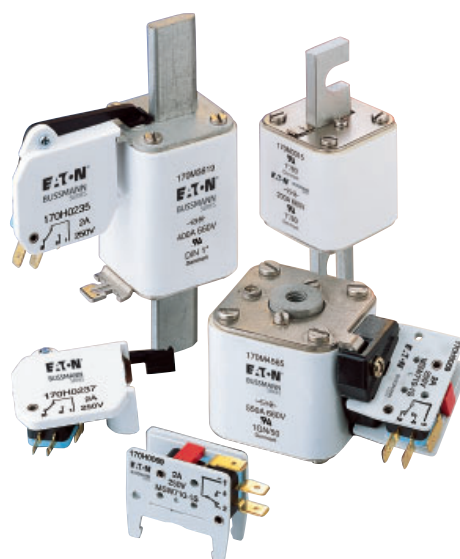

## Microswitches

### Specifications

High Speed square body fuse links with either Type T indicator or Type K indicator can be equipped with a microswitch. For remote electrical indication of fuse link operations. All microswitches have one normally open and one normally closed contact.

### Technical data

- Rated voltage: 10-250 V a.c.
- Rated current: 30mA-2A

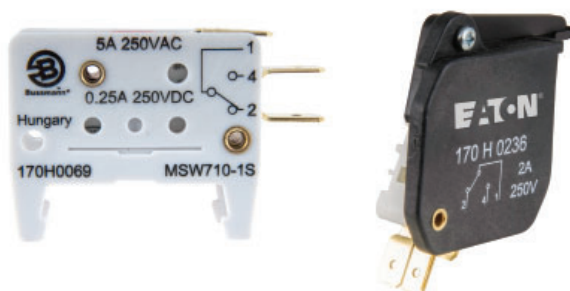

Fuse link body size	DIN 43653		DIN 43620		French style		Flush end		US Style	Terminal size	
	Type T	Type K	aR	gR and dual indication	Type T	Type K	Type T	Type K	Type K	6.3 x 0.8mm lugs	2.8 x 0.5mm lugs
000	170H0236		170H0236	170H0236						X	
	170H0238		170H0238	170H0238							X
00	170H0235		170H0236	170H0236			170H0235			X	
	170H0237		170H0238	170H0238			170H0237				X
1*	170H0235	170H0069	170H0235		170H0236	170H0069		170H0069	170H0069	X	
	170H0237		170H0237		170H0238						X
1	170H0235	170H0069	170H0235 <sup>1</sup>	170H0236	170H0236	170H0069		170H0069	170H0069	X	
	170H0237		170H0237 <sup>1</sup>	170H0238	170H0238						X
2	170H0235	170H0069	170H0235	170H0236	170H0236	170H0069		170H0069	170H0069	X	
	170H0237		170H0237	170H0238	170H0238						X
3	170H0235	170H0069	170H0236	170H0236	170H0236	170H0069		170H0069	170H0069	X	
	170H0237		170H0238	170H0238	170H0238						X
4								170H0069		X	
23								170H0069		X	
24								170H0069		X	

For special microswitches, double microswitches, DC rating of the microswitches, lower/higher signal levels and for insulation voltages please contact Eaton: [bulehighspeedtechnical@eaton.com](mailto:bulehighspeedtechnical@eaton.com).

<sup>1</sup> DIN2\* (55x55), if DIN2 then use microswitch 170H0236, 170H0238.

# Accessories

## 170H - Microswitches for square body fuse links - indicator systems

### Dimensions (mm) - 170H0069

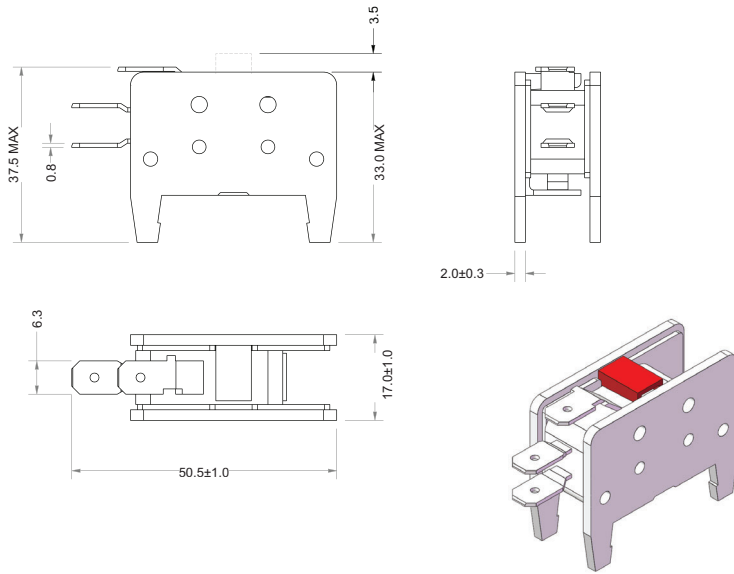

### Dimensions (mm) - 170H0235 and 170H0237 for bent tags

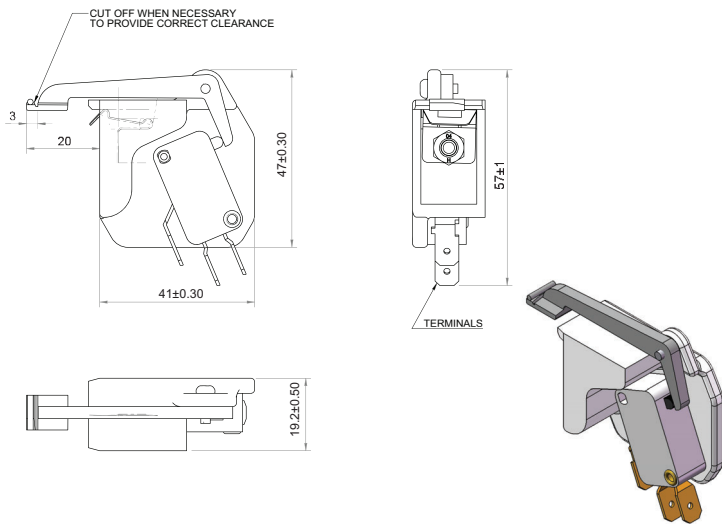

### Dimensions (mm) - 170H0236 and 170H0238 for straight tags

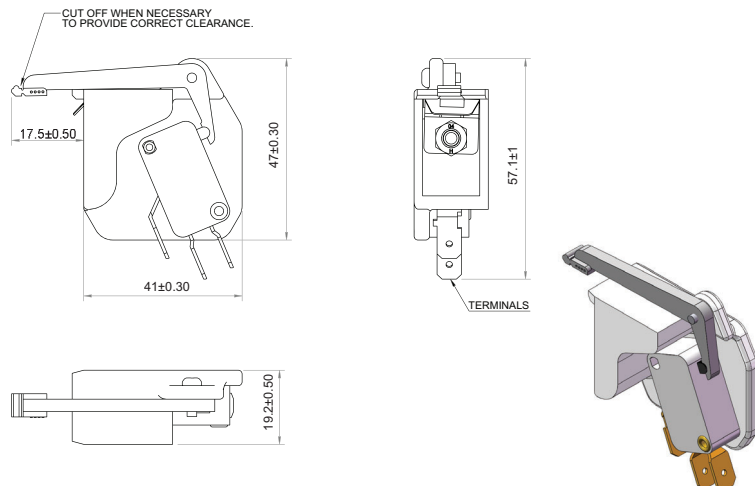

## Microswitches for British Standard BS88-4 fuse links - Trip indicator/Microswitches

### Specifications

Trip-indicator fuse links are available for use in parallel with the main BS88-4 fuse links. They can either be attached to the associated fuse link or mounted separately in panel mounted fuse clips. A push-on adaptor and microswitch attachment is available for use with the trip indicator to give the facility of remote indication.

Fuse ratings of 20 A and below cannot usually accommodate a trip fuse link in parallel.

### Catalogue numbers

Trip indicator kit (indicator + clips)

Fuse type	Catalogue number
ET	EC-600
EET	EC-600
FE	EC-600
FEE	EC-600
LET	EC-250
FM	MC-600
FMM	MC-600
LMT	MC-250
LMMT	MC-250
MT	MC-700
MMT	MC-700



Indicator Only

Fuse type	Max RMS AC voltage (V a.c. RMS)	Dim 'A' (mm)
TI250	250	37.6
TI500	500	47.5
TI600	600	55.7
TI700	700	61.8
TI1100	1100	98.4
TI1500	1500	120.8
TI2000	2000	147.5
TI2500	2500	198.3

### Dimensions (mm)

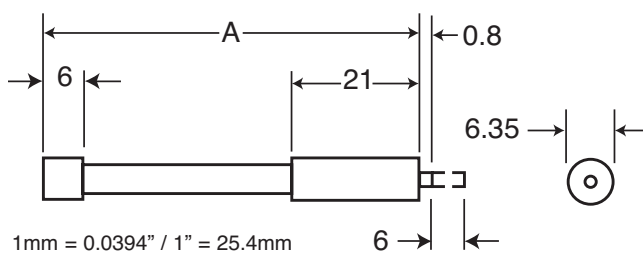

### Microswitch/Adaptor: MAI and MBI

### Dimensions (mm)

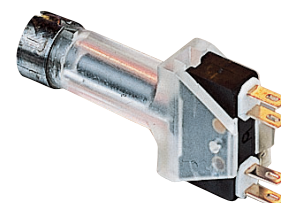
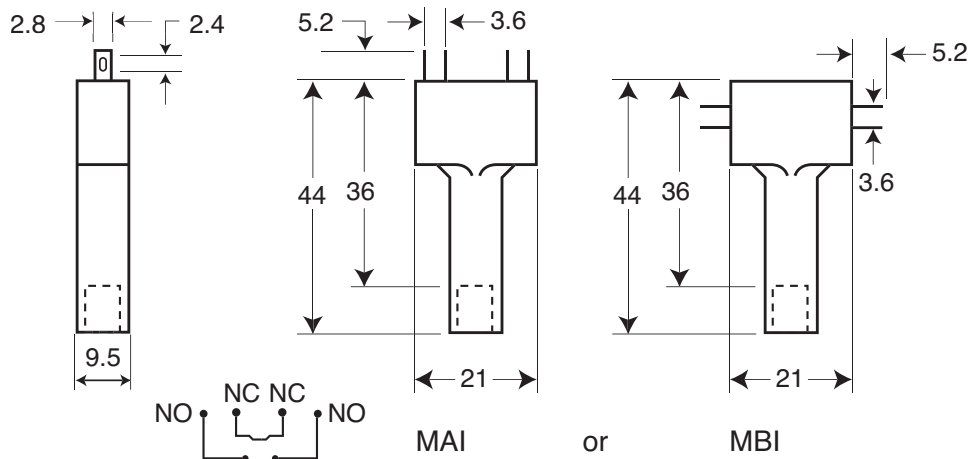

## FW14-PCB Mountable fuse clip

### Specifications

#### Catalogue number

FW14-PCB

#### Description

Mountable fuse clip compatible with any 14 mm Ø fuse links.

#### Technical data

- Max rated power acceptance: 6 Watts

Please note deratings apply to fuse links with watts loss greater than 6 Watts, contact [bulehighspeedtechnical@eaton.com](mailto:bulehighspeedtechnical@eaton.com) for application assistance

- Material: Copper Alloy CuSn, tin plated
- Weight: 5 grams each

#### Compatible fuse links

- Any 14 mm Ø fuse links

#### Standards / Agency information

IEC 60269-1

#### Dimensions (mm)

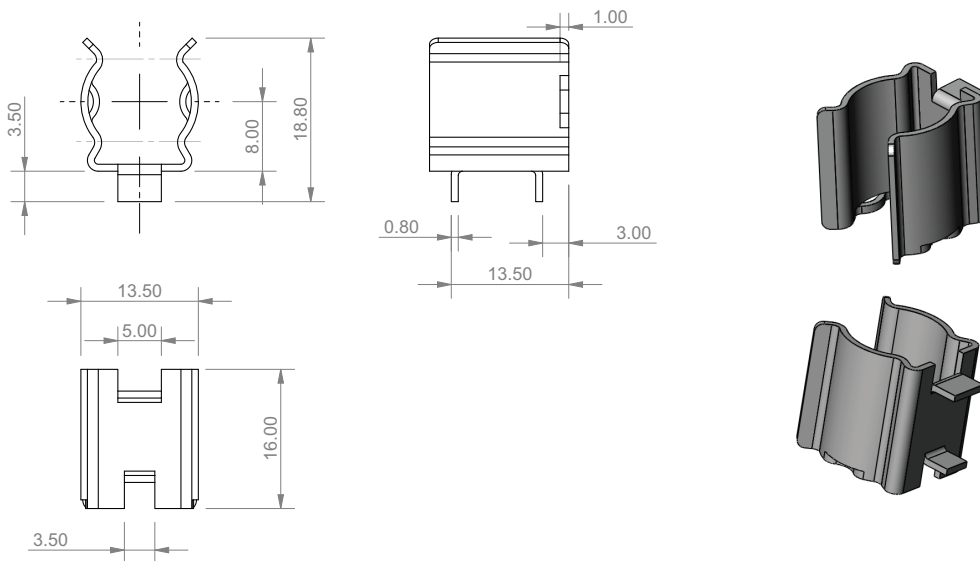

Appropriate creepage and clearances distances between clips should be maintained when mounting on the PCB.

# Customised fuse design service

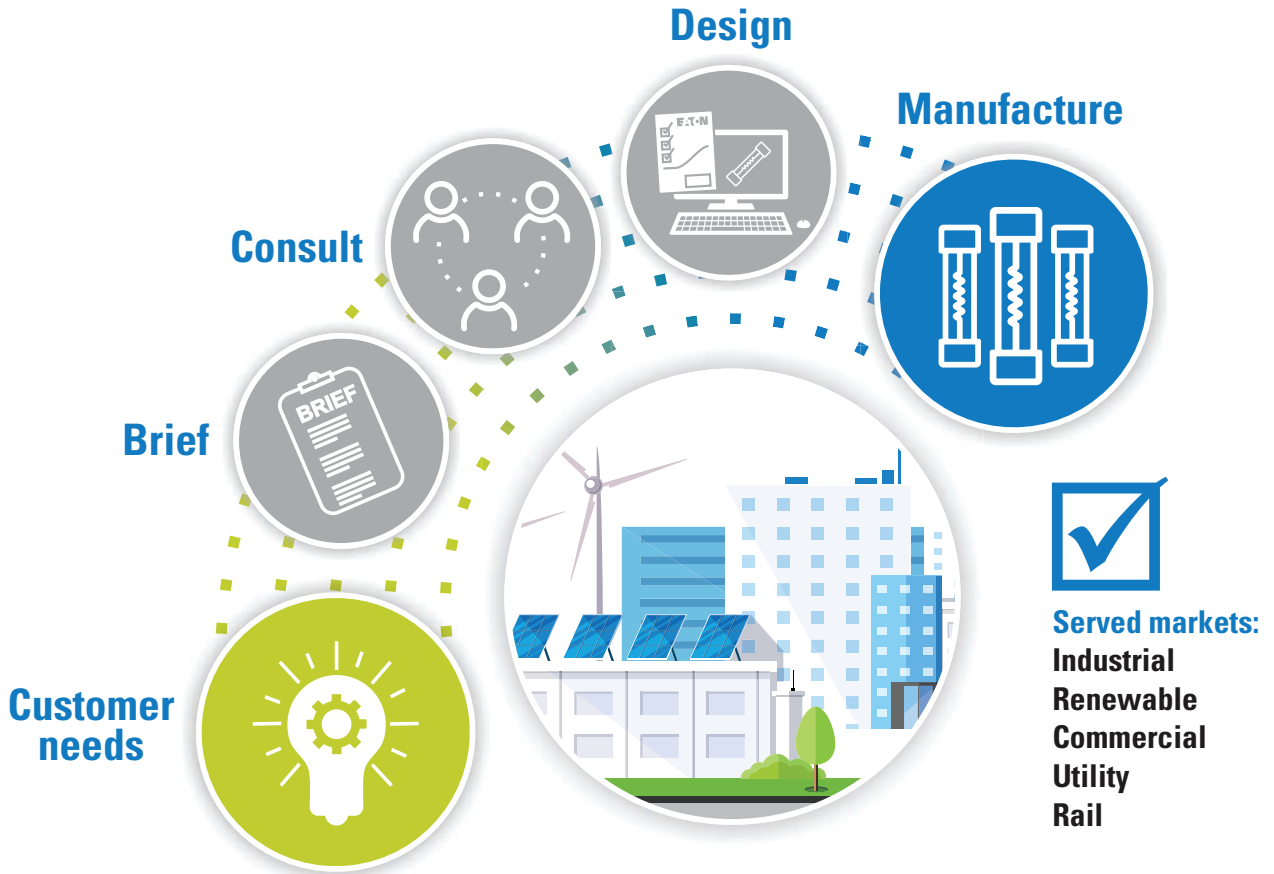

**Eaton's Field Applications Engineers** are able to draw upon more than 100 years of fuse design knowledge to fully meet your application needs and ensure you can rely on the best in class electrical circuit protection solutions.

As the trend towards clean energy continues to drive new technologies in renewable energy generation, energy storage, electrical transportation and the adoption of DC technology throughout wider industries, the demand for customised fusing products has only increased.

Our Application and Design Engineers located at R&D centres in North America, Europe and Asia can leverage over 100 years of fuse design and application experience along with our in-house test labs to meet any customised solution requests for **Eaton's Bussmann series fuses**.

Our services include:

- New current/voltage ratings
- Design to meet I2t requirements
- Customised mounting connection and plating materials
- Modify indicator locations/ add or remove indicators
- Special end connections
- Acquire UL/IEC/CCC/CSA certificates
- Customised testing such as shock vibration
- Higher breaking capacity testing

**Contact us today:**

**For general fuse enquiries:** [buletechnical@eaton.com](mailto:buletechnical@eaton.com)

**For high speed fuses enquiries :** [bulehighspeedtechnical@eaton.com](mailto:bulehighspeedtechnical@eaton.com)

**EATON**

*Powering Business Worldwide*

# Index

Catalogue number	Page	Catalogue number	Page	Catalogue number	Page
170E3577 to 170E3581	275	170M3808D to 170M3819D	141	170M6138 to 170M6151	121
170E3583 to 170E3587	275	170M3921 to 170M3931	207	170M6158 to 170M6171	98
170E3906 to 170E3912	292	170M3951 to 170M3961	207	170M6188 to 170M6201	121
170E3914 to 170E3919	309	170M3965 to 170M3975	111	170M6208 to 170M6221	98
170E3922	309	170M3981 to 170M3991	111	170M6208 to 170M6221	98
170E3924 to 170E3932	306	170M4008 to 170M4019	98	170M6238 to 170M6251	121
170E3933	309	170M4058 to 170M4069	98	170M6258 to 170M6271	98
170E3937 to 170E3945	295	170M4108 to 170M4119	98	170M6308 to 170M6319	164
170E3950 to 170E3956	295	170M4138 to 170M4147	121	170M6338 to 170M6349	217
170E3970	295	170M4158 to 170M4169	98	170M6358 to 170M6369	164
170E3971	292	170M4176 to 170M4186	131	170M6408 to 170M6421	197
170E3976	295	170M4188 to 170M4197	121	170M6458 to 170M6471	197
170E3977	292	170M4208 to 170M4219	98	170M6494 to 170M6501	217
170E3982	292	170M4238 to 170M4247	121	170M6508 to 170M6521	197
170E3984	309	170M4258 to 170M4269	98	170M6538 to 170M6549	217
170E5417	275	170M4308 to 170M4318	154	170M6558 to 170M6571	197
170E5418	275	170M4358 to 170M4368	154	170M6588 to 170M6599	217
170E5420	275	170M4388 to 170M4397	217	170M6608 to 170M6621	164
170E5421	275	170M4408 to 170M4419	197	170M6644 to 170M6651	217
170E8335 to 170E8337	275	170M4438 to 170M4447	217	170M6658 to 170M6671	164
170E8345 to 170E8347	275	170M4458 to 170M4469	197	170M6688 to 170M6701	184
170E8882 to 170E8889	309	170M4458 to 170M4469	197	170M6708 to 170M6721	164
170E9681	275	170M4488 to 170M4497	217	170M6738 to 170M6751	184
170E9685	275	170M4508 to 170M4519	197	170M6758 to 170M6771	165
170F8230 to 170F8235	290	170M4531 to 170M4540	174	170M6775 to 170M6804	246
170H0069	393	170M4558 to 170M4569	197	170M6808D to 170M6814D	141
170H023	393	170M4608 to 170M4619	164	170M6815 to 170M6817	246
170H1007	378	170M4658 to 170M4669	164	170M6827 to 170M6829	246
170H1013	378	170M4688 to 170M4697	184	170M6833 to 170M6835	246
170H300	379	170M4708 to 170M4719	164	170M6858 to 170M6870	242
170M1308 to 170M1322	93	170M4738 to 170M4747	184	170M6878 to 170M6890	242
170M1358 to 170M1372	93	170M4758 to 170M4769	164	170M6892D	141
170M1408 to 170M1422	93	170M4802 to 170M4815	108	170M6898 to 170M6910	242
170M1558D to 170M1572D	141	170M4822 to 170M4835	108	170M6918 to 170M6930	242
170M1730 to 170M1742	259	170M4863D to 170M4867D	141	170M6938 to 170M6950	242
170M1750 to 170M1762	259	170M4921 to 170M4930	207	170M6958 to 170M6970	242
170M1770 to 170M1781	259	170M4951 to 170M4960	207	170M7031	230
170M1785 to 170M1796	259	170M4965 to 170M4974	111	170M7034 to 170M7037	230
170M1802 to 170M1813	265	170M4980 to 170M4989	111	170M7053	230
170M1824 to 170M1833	265	170M5008 to 170M5018	98	170M7058 to 170M7066	227
170M1842 to 170M1853	265	170M5058 to 170M5068	98	170M7078 to 170M7086	227
170M1860 to 170M1869	265	170M5108 to 170M5118	98	170M7090	230
170M2000 to 170M2005	271	170M5138 to 170M5150	121	170M7098 to 170M7106	227
170M2010 to 170M2021	271	170M5158 to 170M5168	98	170M7107	236
170M2039 to 170M2045	300	170M5188 to 170M5200	121	170M7114	227
170M2046 to 170M2057	300	170M5208 to 170M5218	98	170M7116	227
170M2090 to 170M2096	304	170M5238 to 170M5250	121	170M7118 to 170M7126	227
170M2100 to 170M2111	288	170M5258 to 170M5268	98	170M7138 to 170M7147	249
170M2608 to 170M2621	93	170M5308 to 170M5316	154	170M7156	230
170M2658 to 170M2671	93	170M5358 to 170M5366	154	170M7158 to 170M7167	249
170M2673 to 170M2685	151	170M5388 to 170M5398	217	170M7171	227
170M2691 to 170M2702	131	170M5408 to 170M5418	197	170M7173	227
170M2708 to 170M2721	194	170M5438 to 170M5448	217	170M7198 to 170M7207	249
170M2758 to 170M2771	194	170M5458 to 170M5468	197	170M7217	285
170M3008 to 170M3023	98	170M5494 to 170M5500	217	170M7218 to 170M7227	249
170M3058 to 170M3073	98	170M5508 to 170M5518	197	170M7340	227
170M3108 to 170M3123	98	170M5531 to 170M5540	174	170M7350 to 170M7358	336
170M3138 to 170M3148	121	170M5558 to 170M5568	197	170M7353-B to 170M7402-B	336
170M3158 to 170M3173	98	170M5588 to 170M5598	217	170M7397 to 170M7402	336
170M3188 to 170M3198	121	170M5608 to 170M5618	164	170M7488	252
170M3208 to 170M3223	98	170M5644 to 170M5650	217	170M7498	252
170M3238 to 170M3248	121	170M5658 to 170M5668	164	170M7510 to 170M7513	236
170M3258 to 170M3273	98	170M5688 to 170M5700	184	170M7516	236
170M3308 to 170M3321	154	170M5708 to 170M5718	164	170M7532	236
170M3358 to 170M3371	154	170M5738 to 170M5750	184	170M7542	230
170M3388 to 170M3397	217	170M5758 to 170M5768	164	170M7544	230
170M3408 to 170M3423	197	170M5808D to 170M5814D	141	170M7546	236
170M3438 to 170M3448	217	170M5816D	141	170M7548	230
170M3458 to 170M3473	197	170M5817D	141	170M7567 to 170M7569	252
170M3488 to 170M3497	217	170M5820D	141	170M7592	236
170M3508 to 170M3523	197	170M5881 to 170M5889	131	170M7595	236
170M3531 to 170M3541	174	170M5922 to 170M5931	207	170M7597	236
170M3558 to 170M3573	197	170M5952 to 170M5961	207	170M7608	252
170M3608 to 170M3623	164	170M5966 to 170M5975	111	170M7622	252
170M3658 to 170M3673	164	170M5981 to 170M5990	111	170M7633	236
170M3688 to 170M3697	184	170M6008 to 170M6021	98	170M7636	230
170M3708 to 170M3723	164	170M6058 to 170M6071	98	170M7639	230
170M3738 to 170M3747	184	170M6080 to 170M6087	131	170M7640	230
170M3758 to 170M3773	164	170M6108 to 170M6121	98	170M7658	230

# Index

Catalogue number	Page
170M7661	230
170M7676	236
170M7680	252
170M7692	230
170M7693	230
170M7802 to 170M7804	236
170M7976	236
170M7978	236
170M8500 to 170M8513	207
170M8531 to 170M8544	174
170M8554D to 170M8557D	141
170M8600 to 170M8613	207
170M8614 to 170M8627	111
170M8629 to 170M8642	111
17M1408 to 170M1422	93
1BS	377
BH	377
BMM	381
BSF-G-3XL15	374
BSF-G-NH	368
C5268	377
CH14	389
CH14-CTP	390
CH14-SPS	390
CH14-TPS	390
CH22	391
CH22-CTP	392
CH22-SPS	392
CH22-TPS	392
CHCC	387
CHM	387
CHPV_IU	326
CHPV_U	326 and 387
CHPV14	332
CHPV15H85	329
CHSF	16
CT	47
CVR	384
DFJ	256
EC	395
EET	47
ET	47
FE	47
FEE	47
FM	52
FMM	52
FW14-PCB	396
FWA-A	9
FWA-A10F	58
FWA-A21F	58
FWA-AH	6
FWA-B	9
FWC-A10F	68
FWE	34
FWH-A	20
FWH-A14F	66
FWH-A6F	64
FWH-B	20
FWJ	31
FWJ-A14F	86
FWK	84
FWK-A20F	315
FWK-A25F	315
FWL-A20F	88
FWL-A20F	317
FWP-A	25
FWP-A14F	79
FWP-A22F	82
FWP-B	25
FWP-D	25
FWP-G10F	70
FWP-G14F	73
FWP-G22F	76
FWS-A20F	90
FWS-A20F	317
FWX-A	13
FWX-A14F	61
FWX-AH	13
JM60	384

Catalogue number	Page
JM70100	383
JV-L	390 and 392
KAC	23
KBC	24
KC36	318
LCT	40
LET	40
LMMT	44
LMT	44
LRC750	316
MC	395
MMT	52
MT	52
NBC	320
PV-3L	357
PV-3L-15	357
PV-A10	323
PV-A10F85L	327
PV-A14F	330
PV-A14L	333
PV-A14LF10F	333
PV-A14L-T	333
PV-AF	354
PV-ANH	343
PVM	321
PV-XL	357
PV-XL-15	357
RC	319
SD-D-PV	352
SD-S-PV	367
TI	395



# Hybrid Electric Vehicles

As the automotive world is becoming ever more electrified the power requirements are changing, so have the protection needs. Eaton is continually developing designs to meet these ever changing requirements. The experience of Eaton in protecting semiconductor devices has proved invaluable as vehicle powertrain systems have moved to power based converters for the variable speed motor drives and also for auxiliary power conversion.

Utilising a global network of engineering, manufacture and distribution Eaton is able to draw upon a wealth of knowledge to fully meet your application needs.

## Hybrid Electric Vehicles (HEV)

Standards	Most commonly ISO 8820-8, Jaso D622 amongst others
Voltage	Options up to 1000 V d.c., please contact Eaton's Bussmann series Application engineers to discuss your specific requirements
Current	Options up to 1250 A, please contact Eaton's Bussmann series Application engineers to discuss your specific requirements
Operating class	aR & gR
Breaking capacity	Up to 150 kA
Applications	Batteries, converters, inverters, charging circuits and auxiliary circuits

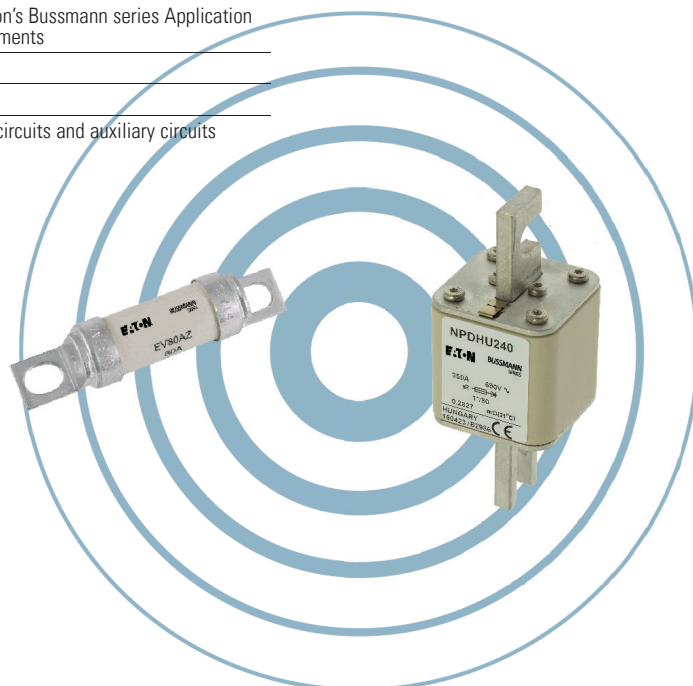



# Contact details

## Customer Satisfaction team

Eaton's Customer Satisfaction team is available to answer questions regarding Bussmann series products.

Calls can be made between:

Monday - Friday 7.30 a.m. - 5.00 p.m. GMT

The Customer Satisfaction team can be reached via:

Phone: 00 44 (0) 1509 882 600

Fax: 00 44 (0) 1509 882 786

Email: GBBURsales@eaton.com

## www.my.eaton.com

Tailored just for you. Powerful online tools and resources get you the up-to-date information you need to work smarter, make informed decisions and streamline your transactions with Eaton.

Get started today at [www.my.eaton.com](http://www.my.eaton.com) by clicking 'Request User ID and Password'.

- Easy to Navigate
- Simple to Use
- Real-Time Data.

## Online resources

Visit [www.eaton.com](http://www.eaton.com) for the following resources:

- Product cross reference
- Product profiles
- Online catalogues for the latest United States and European catalogues.

## Application engineering

Application Engineering assistance is available to all customers. The Application Engineering team is staffed by university-qualified electrical engineers who are available with technical and application support.

Calls can be made between:

Monday - Thursday 8.30 a.m. - 4.30 p.m. GMT

Friday 8.30 a.m. - 4.00 p.m. GMT

Application Engineering can be reached via:

Phone: 00 44 (0) 1509 882 699

Fax: 00 44 (0) 1509 882 794

General technical enquiries:

[buletechnical@eaton.com](mailto:buletechnical@eaton.com)

Enquiries related to High speed fuses:

[bulehighspeedtechnical@eaton.com](mailto:bulehighspeedtechnical@eaton.com)

Eaton's electrical business is a global leader with deep regional application expertise in power distribution and circuit protection; power quality, backup power and energy storage; control and automation; life safety and security; structural solutions; and harsh and hazardous environment solutions. Through end-to-end services, channel and an integrated digital platform & insights Eaton is powering what matters across industries and around the world, helping customers solve their most critical electrical power management challenges.

Eaton's mission is to improve the quality of life and the environment through the use of power management technologies and services. We provide sustainable solutions that help our customers effectively manage electrical, hydraulic and mechanical power – more safely, more efficiently and more reliably.

## Contact your local Eaton office

Eaton Electrical Products Limited  
Unit 1, Hawker Business Park  
Melton Road  
Burton-on-the-Wolds  
LE12 5TH  
Leicestershire  
United Kingdom  
[gbbursales@eaton.com](mailto:gbbursales@eaton.com)  
[www.eaton.com](http://www.eaton.com)

**Eaton Electrical Products Limited**  
Unit 1, Hawker Business Park  
Melton Road  
LE12 5TH  
United Kingdom

© 2020 Eaton  
All Rights Reserved  
Printed in the United Kingdom  
Publication No. CA135001EN  
February 2023

Changes to the products, to the information contained in this document, and to prices are reserved; so are errors and omissions. Only order confirmations and technical documentation by Eaton is binding. Photos and pictures also do not warrant a specific layout or functionality. Their use in whatever form is subject to prior approval by Eaton. The same applies to Trademarks (especially Eaton, Moeller, and Cutler-Hammer). The Terms and Conditions of Eaton apply, as referenced on Eaton Internet pages and Eaton order confirmations.

Eaton is a registered trademark.

All other trademarks are property of their respective owners.