

THIS DRAWING IS UNPUBLISHED. RELEASED FOR PUBLICATION  
 © COPYRIGHT - BY TYCO ELECTRONICS CORPORATION. ALL INTERNATIONAL RIGHTS RESERVED.

LOC	DIST	REVISIONS			
P	LTR	DESCRIPTION	DATE	DWN	APVD
-	-	B	ECR-17-009163	28JUN17	MG BM

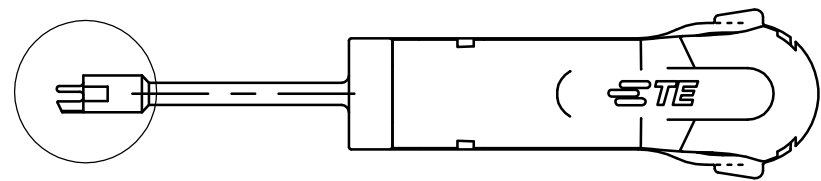

A

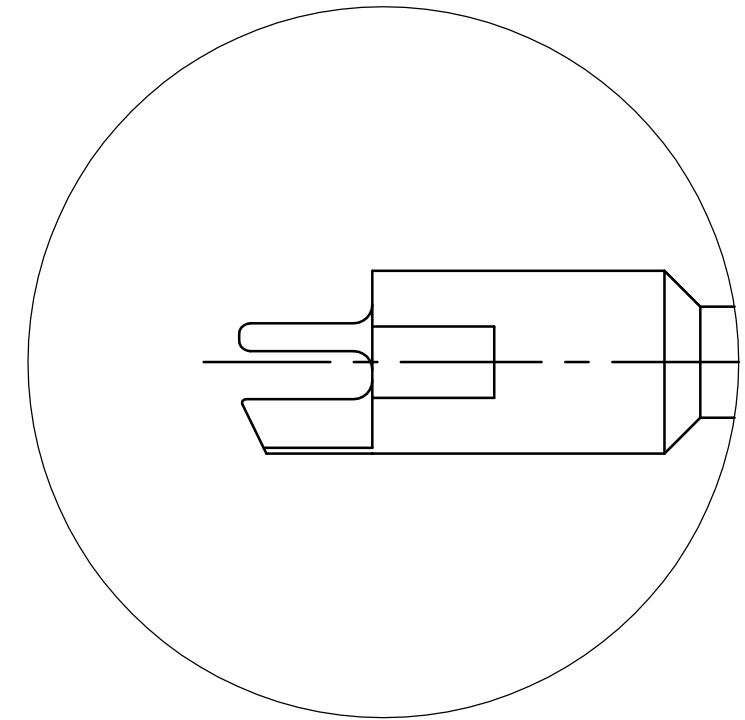

A  
5:1

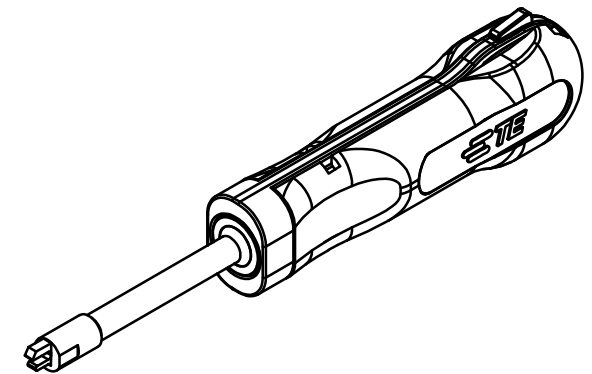
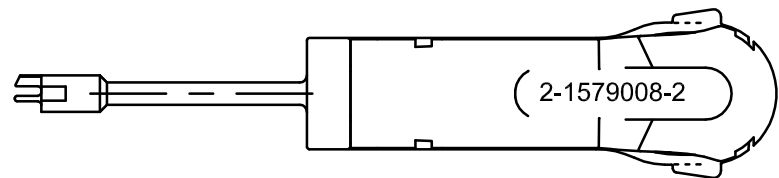
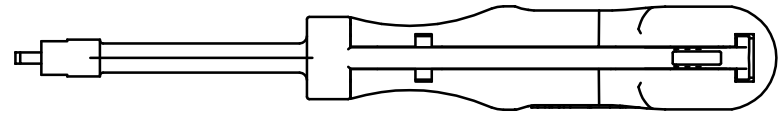

FOR CONTACTS / HOUSINGS:

SICMA 1.5 receptacle with 1 plastic locking latches

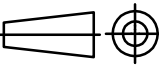
THIS DRAWING IS A CONTROLLED DOCUMENT.		DWN m.pearson	06.11.2006	 TE Connectivity	
DIMENSIONS: mm		CHK -	APVD -		
		TOLERANCES UNLESS OTHERWISE SPECIFIED: 0 PLC ± - 1 PLC ± - 2 PLC ± - 3 PLC ± - 4 PLC ± - ANGLES ± -		PRODUCT SPEC -	
MATERIAL		FINISH		APPLICATION SPEC -	RESTRICTED TO -
		WEIGHT 0.017 kg		SIZE A3	CAGE CODE 00779
		CUSTOMER DRAWING		DRAWING NO C-2-1579008-2	SCALE 1:1
				SHEET 1 OF 1	REV B