

Signal conditioner - MINI MCR-2-I0-U - 2902000

Please be informed that the data shown in this PDF Document is generated from our Online Catalog. Please find the complete data in the user's documentation. Our General Terms of Use for Downloads are valid (<http://phoenixcontact.com/download>)



3-way signal conditioner with plug-in connection technology for the electrical isolation of analog signals. Input signal: 0 ... 20 mA, output signal: 0 ... 10 V, screw connection technology

Product Description

Standard signal 3-way signal conditioner with plug-in connection technology for the electrical isolation, conversion, amplification, and filtering of standard signals. The measuring transducer supports fault monitoring and NFC communication.



Key Commercial Data

Packing unit	1 pc
GTIN	 4 046356 651820
GTIN	4046356651820

Technical data

Note

Utilization restriction	EMC: class A product, see manufacturer's declaration in the download area
-------------------------	---

Dimensions

Width	6.2 mm
Height	110.5 mm
Depth	120.5 mm

Ambient conditions

Ambient temperature (operation)	-40 °C ... 70 °C
Ambient temperature (storage/transport)	-40 °C ... 85 °C

Input data

Number of inputs	1
Configurable/programmable	no
Current input signal	0 mA ... 20 mA

Signal conditioner - MINI MCR-2-I0-U - 2902000

Technical data

Input data

Input resistance current input	approx. 63 Ω (+ 0.7 V for test diode)
--------------------------------	---------------------------------------

Output data

Number of outputs	1
Configurable/programmable	no
Voltage output signal	0 V ... 10 V
Max. output voltage	11 V
Short-circuit current	< 15 mA
Load/output load voltage output	≥ 10 kΩ
Ripple	< 20 mV _{PP} (at 10 kΩ)

Power supply

Nominal supply voltage	24 V DC
Supply voltage range	9.6 V DC ... 30 V DC (The DIN rail bus connector (ME 6,2 TBUS-2 1,5/5-ST-3,81 GN, Order No. 2869728) can be used to bridge the supply voltage. It can be snapped onto a 35 mm DIN rail according to EN 60715))
Typical current consumption	25 mA (24 V DC)
	54 mA (12 V DC)
Power consumption	≤ 200 mW (at 9.6 V DC)

Connection data

Connection method	Screw connection
Single conductor/terminal point, solid, with ferrule, min.	0.2 mm ²
Single conductor/terminal point, solid, with ferrule, max.	1.5 mm ²
Single conductor/terminal point, solid, without ferrule, min.	0.2 mm ²
Single conductor/terminal point, solid, without ferrule, max.	2.5 mm ²
Conductor cross section flexible min.	0.2 mm ²
Conductor cross section flexible max.	1.5 mm ²
Min. AWG conductor cross section, flexible	24
Max. AWG conductor cross section, flexible	12
Stripping length	10 mm
Screw thread	M3

General

No. of channels	1
Maximum transmission error	0.1 % (of final value)
Maximum temperature coefficient	0.01 %/K
Temperature coefficient, typical	0.01 %/K
Limit frequency (3 dB)	approx. 30 Hz
Step response (10-90%)	approx. 10 ms
Protective circuit	Transient protection
Electrical isolation	Reinforced insulation in accordance with IEC 61010-1
Overvoltage category	II

Signal conditioner - MINI MCR-2-I0-U - 2902000

Technical data

General

Degree of pollution	2
Rated insulation voltage	300 V (effective)
Test voltage, input/output/supply	3 kV (50 Hz, 1 min.)
Electromagnetic compatibility	Conformance with EMC directive
Noise emission	EN 61000-6-4
Noise immunity	EN 61000-6-2 When being exposed to interference, there may be minimal deviations.
Color	gray
Housing material	PBT
Mounting position	any
Assembly instructions	The T connector can be used to bridge the supply voltage. It can be snapped onto a 35 mm DIN rail according to EN 60715.
Conformance	CE-compliant
ATEX	# II 3 G Ex nA IIC T4 Gc X
UL, USA/Canada	UL 508 Listed
	Class I, Div. 2, Groups A, B, C, D T6
	Class I, Zone 2, Group IIC T6
Certificate of classification	DNV GL 14445-15HH
Fire protection for rail vehicles (DIN EN 45545-2) R22	HL 1 - HL 2
Fire protection for rail vehicles (DIN EN 45545-2) R23	HL 1 - HL 2
Fire protection for rail vehicles (DIN EN 45545-2) R24	HL 1 - HL 2

EMC data

Designation	Electromagnetic RF field
Standards/regulations	EN 61000-4-3
Designation	Fast transients (burst)
Standards/regulations	EN 61000-4-4
Designation	Conducted interferences
Standards/regulations	EN 61000-4-6

Standards and Regulations

Electromagnetic compatibility	Conformance with EMC directive
Noise emission	EN 61000-6-4
Standards/regulations	EN 61000-4-2
Designation	Electromagnetic RF field
Standards/regulations	EN 61000-4-3
	EN 61000-4-4
	EN 61000-4-5
Designation	Conducted interferences
Standards/regulations	EN 61000-4-6
Electrical isolation	Reinforced insulation in accordance with IEC 61010-1
Conformance	CE-compliant

Signal conditioner - MINI MCR-2-I0-U - 2902000

Technical data

Standards and Regulations

ATEX	# II 3 G Ex nA IIC T4 Gc X
UL, USA/Canada	UL 508 Listed
	Class I, Div. 2, Groups A, B, C, D T6
	Class I, Zone 2, Group IIC T6
Fire protection for rail vehicles (DIN EN 45545-2) R22	HL 1 - HL 2
Fire protection for rail vehicles (DIN EN 45545-2) R23	HL 1 - HL 2
Fire protection for rail vehicles (DIN EN 45545-2) R24	HL 1 - HL 2

Environmental Product Compliance

China RoHS	Environmentally Friendly Use Period = 50
	For details about hazardous substances go to tab "Downloads", Category "Manufacturer's declaration"

Drawings

Pictogram



Block diagram

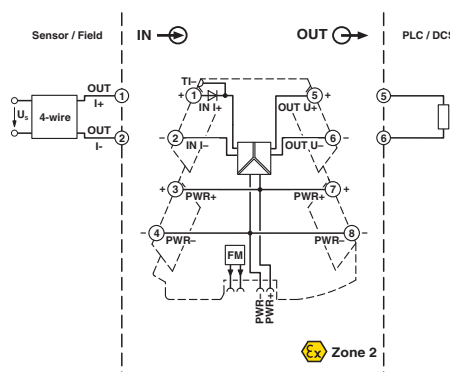

Pictogram

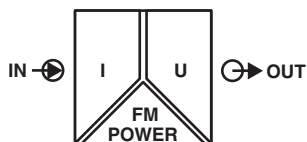

Signal conditioner - MINI MCR-2-10-U - 2902000

Approvals

Approvals





Approvals

GL / UL Listed / cUL Listed / cULus Listed

Ex Approvals

ATEX / UL Listed / cUL Listed / cULus Listed

Approval details

GL		http://exchange.dnv.com/tari/	14445-15 HH
UL Listed		http://database.ul.com/cgi-bin/XYV/template/LISEXT/1FRAME/index.htm	FILE E 238705
cUL Listed		http://database.ul.com/cgi-bin/XYV/template/LISEXT/1FRAME/index.htm	FILE E 238705
cULus Listed			

Phoenix Contact 2018 © - all rights reserved
<http://www.phoenixcontact.com>

PHOENIX CONTACT GmbH & Co. KG
Flachsmarktstr. 8
32825 Blomberg
Germany
Tel. +49 5235 300
Fax +49 5235 3 41200
<http://www.phoenixcontact.com>