

Electronic device circuit breaker - ECP-E 3A - 0900317

Please be informed that the data shown in this PDF Document is generated from our Online Catalog. Please find the complete data in the user's documentation. Our General Terms of Use for Downloads are valid (<http://phoenixcontact.com/download>)



Electronic device circuit breaker, number of positions: 1, connection method: Screw connection, width: 12.5 mm, fuse type: electronic, fuse type: Automatic device, mounting type: on base element, Color: black

Why buy this product

- Can be plugged onto TMCP SOCKET M base
- Design width of just 12.5 mm
- The operating or error state is indicated by a multi-color LED as well as an integrated status output (12)



Key Commercial Data

Packing unit	5 STK
GTIN	
GTIN	4046356103985

Technical data

General

Installation instructions	When mounted in rows without convection cooling, the nominal device current should only be led to a maximum of 80% due to the thermal effect during continuous operation (100% operating factor). Special precautionary measures must be taken in systems or machines, to prevent components from restarting (e.g., use of a safety PLC). Parallel connection of multiple circuit breakers is not permitted.
Mounting type	on base element
Color	black
Number of positions	1
Overvoltage category_GRP	II
Insulating material	PA66/6
Flammability rating according to UL 94	V0

Electrical data

Fuse	electronic
Fuse type	Automatic device

Electronic device circuit breaker - ECP-E 3A - 0900317

Technical data

Electrical data

Rated surge voltage	0.5 kV
Operating voltage	24 V DC
	24 V DC (at 50 °C (UL 2367, UL 508, ANSI/ISA 12.12.01))
	18 V DC ... 32 V DC
Nominal current I_N	3 A
Required backup fuse	not required, integrated failsafe element
Dielectric strength	max. 32 V DC (Load circuit)
Degree of pollution	2
Overvoltage category_GRP	II
Insulating material group	I
Switching capacity I_{CN}	Active current limitation
Closed-circuit current range I_0	typ. 25 mA \pm 5 mA (When switched on)

Dimensions

Height	60 mm
Width	12.5 mm
Depth	70 mm
Height NS 35/7,5	144 mm
Height NS 35/15	151.5 mm
Complete module height	115 mm
Complete module width	38 mm
Complete module depth	112.5 mm

Ambient conditions

Degree of protection	IP30 (Actuation area)
Ambient temperature (operation)	0 °C ... 50 °C (non-condensing)

Connection data

Connection method	Screw connection
-------------------	------------------

Standards and Regulations

Standards/specifications	UL 2367
	UL 508
	CSA 22.2 No. 14

Environmental Product Compliance

REACH SVHC	Lead 7439-92-1
------------	----------------

Drawings

Electronic device circuit breaker - ECP-E 3A - 0900317

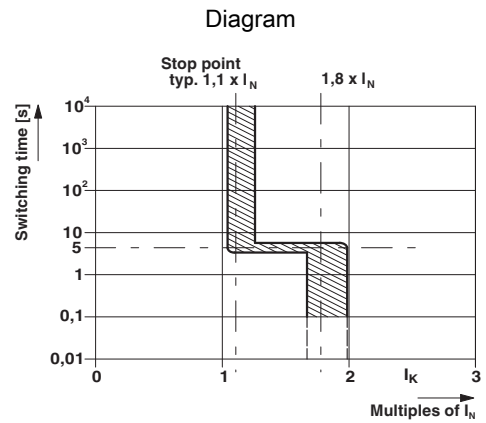
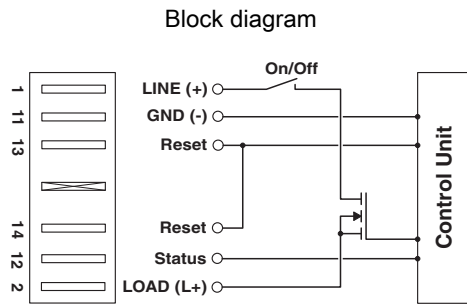

Approvals

Approvals

Approvals

UL Recognized / EAC / EAC

Ex Approvals

CSA / UL Recognized

Approval details

UL Recognized		http://database.ul.com/cgi-bin/XYV/template/LISEXT/1FRAME/index.htm	FILE E 317172
---------------	--	---	---------------

EAC		EAC-Zulassung
-----	--	---------------

EAC		RU C- DE.A*30.B01561
-----	--	-------------------------

Phoenix Contact 2018 © - all rights reserved
<http://www.phoenixcontact.com>

PHOENIX CONTACT GmbH & Co. KG
Flachmarktstr. 8
32825 Blomberg
Germany
Tel. +49 5235 300
Fax +49 5235 3 41200
<http://www.phoenixcontact.com>