

Printed-circuit board connector - DMCV 1,5/16-G1-3,5 P20THR - 1787344

Please be informed that the data shown in this PDF Document is generated from our Online Catalog. Please find the complete data in the user's documentation. Our General Terms of Use for Downloads are valid (<http://phoenixcontact.com/download>)

PCB headers, nominal current: 8 A, rated voltage (III/2): 160 V, number of positions: 16, pitch: 3.5 mm, color: black, contact surface: Tin, mounting: THR soldering



The figure shows a 10-pos. version with 20 contacts

Why buy this product

- ✓ Designed for integration into the SMT soldering process
- ✓ Vertical connection enables multi-row arrangement on the PCB
- ✓ Small component size for applications where space is at a premium

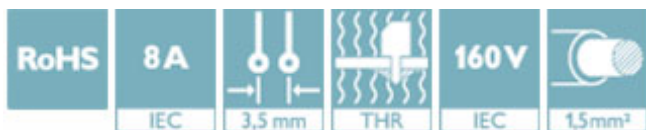

Key Commercial Data

Packing unit	50 STK
GTIN	 4 046356 596961
GTIN	4046356596961

Technical data

Dimensions

Length [l]	10.6 mm
Pitch	3.5 mm
Dimension a	52.5 mm
Width [w]	56.8 mm
Constructional height	10 mm
Height [h]	12 mm
Length of the solder pin	2 mm
Pin dimensions	0,8 x 0,8
Pin spacing	5.50 mm
Hole diameter	1.4 mm

Printed-circuit board connector - DMCV 1,5/16-G1-3,5 P20THR - 1787344

Technical data

General

Range of articles	DMCV 1,5/...G1-THR
Insulating material group	IIIa
Rated surge voltage (III/3)	2.5 kV
Rated surge voltage (III/2)	2.5 kV
Rated surge voltage (II/2)	2.5 kV
Rated voltage (III/3)	160 V
Rated voltage (III/2)	160 V
Rated voltage (II/2)	250 V
Connection in acc. with standard	EN-VDE
Nominal current I_N	8 A
Maximum load current	8 A
Insulating material	LCP
Flammability rating according to UL 94	V0
Color	black
Number of positions	16

Standards and Regulations

Connection in acc. with standard	EN-VDE
	CUL
Flammability rating according to UL 94	V0

Environmental Product Compliance

China RoHS	Environmentally friendly use period: unlimited = EFUP-e
	No hazardous substances above threshold values

Drawings

Diagram

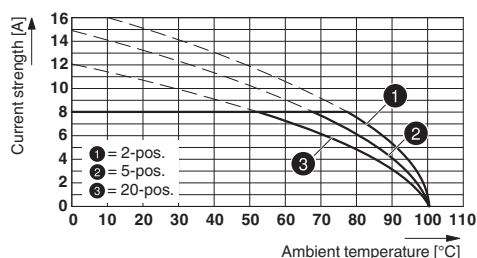

Schematic diagram

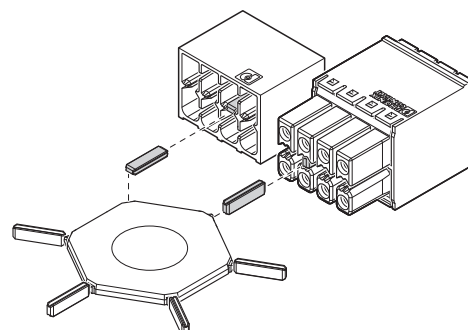

Typ: DFMC 1,5/...-ST-3,5 with DMCV 1,5/...-G1-3,5 P20 THR

Use of the CP-DMC... coding profile

Printed-circuit board connector - DMCV 1,5/16-G1-3,5 P20THR - 1787344

Drilling diagram

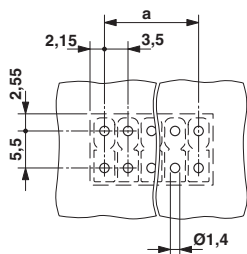

Dimensional drawing

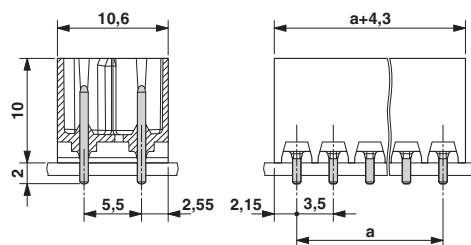

Approvals

Approvals

Approvals

VDE Gutachten mit Fertigungsüberwachung / IECEE CB Scheme / EAC / cULus Recognized

Ex Approvals

Approval details

VDE Gutachten mit Fertigungsüberwachung		http://www2.vde.com/de/Institut/Online-Service/VDE-gepruefteProdukte/Seiten/Online-Suche.aspx	40038423
Nominal current I _N	8 A		
Nominal voltage U _N	160 V		

IECEE CB Scheme		http://www.iecee.org/	DE1-60359_B1_B2
Nominal current I _N	8 A		
Nominal voltage U _N	160 V		

EAC		B.01742	
-----	--	---------	--

Printed-circuit board connector - DMCV 1,5/16-G1-3,5 P20THR - 1787344

Approvals

cULus Recognized		http://database.ul.com/cgi-bin/XYV/template/LISEXT/1FRAME/index.htm	E60425-20110128
	B	C	D
Nominal current I _N	8 A	8 A	8 A
Nominal voltage U _N	300 V	50 V	300 V

Phoenix Contact 2018 © - all rights reserved
<http://www.phoenixcontact.com>

PHOENIX CONTACT GmbH & Co. KG
Flachsmarktstr. 8
32825 Blomberg
Germany
Tel. +49 5235 300
Fax +49 5235 3 41200
<http://www.phoenixcontact.com>