



SERIES IEF | INSERTION ELECTROMAGNETIC FLOW TRANSMITTER



FEATURES/BENEFITS

- Field configurable, integral or remote displays allow for ultimate flexibility by accommodating a variety of applications through multiple display configurations
- High performance accuracy is maintained through changes in temperature, density, and viscosity
- Setup Wizard and installation tool are simple to use allowing for quick and precise installation
- Accessory setup kit A-IEF-KIT ensures exact installation application depth with included thickness gage and measuring tape
- Long life cycle and minimal maintenance requirements with no moving parts to wear or break and electrodes that discourage fouling
- Isolation valve accessory options allow for installation in operational systems via hot-tap kit or easy removal without system downtime
- NIST calibration certificate included standard for Carbon Steel Schedule 40 pipes sized 4" (102 mm), 6" (150 mm), 8" (200 mm), and 10" (250 mm) with high accuracy option



Shown with A-IEF-VLV-BR accessory valve

APPLICATIONS

- | | |
|--|----------------------------|
| • Boiler feed water | • Ground water remediation |
| • Chilled water | • Chemical processing |
| • Open and closed loop condenser water | • Pump protection |
| • Irrigation system | • Wastewater |
| • Municipal water distribution | • Mining |
| • Process and coolant flow | |

DESCRIPTION

The **SERIES IEF** Insertion Electromagnetic Flow Transmitter is an adjustable insertion flowmeter featuring electromagnetic technology that accurately and reliably measures fluid velocity in addition to providing several continuous signal outputs. This series is specifically designed to offer superior performance paired with simple installation and use. One unit is adjustable to fit pipe sizes from 4 to 36" (102 to 914 mm), and offers several output options including selectable BACnet MS/TP or Modbus® RTU communications protocol over 2-wire RS-485 in addition to the standard analog, frequency and alarm outputs.



-LCD option shown

Modbus® is a registered trademark of Schneider Automation, Inc.



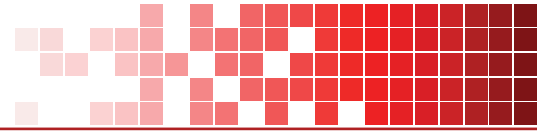

SPECIFICATIONS

Service	Compatible clean or dirty non coating, conductive liquids.
Range	0 to 20 ft/s (0 to 6 m/s).*
Wetted Materials	Body shaft/fitting: 316 SS; Electrodes: 316 SS; Electrode cap: Polymer/Polystyrene; O-ring: Silicone.
Accuracy	IEF-HX-X: $\pm 0.5\%$ of reading at calibrated velocity; $\pm 1\%$ of reading from 2 to 20 ft/s (0.6 to 6 m/s); ± 0.02 ft/s (± 0.006 m/s) at < 2 ft/s (0.6 m/s); IEF-SX-X: $\pm 1\%$ FS.
Temperature Limits	Ambient: -20 to 160°F (-29 to 71°C); Process: 15 to 250°F (121°C); Storage: -40 to 185°F (-40 to 85°C).
Process Connection	1" NPT or BSPT with accessory full port ball valve options.
Pressure Limits	400 psi (27.6 bar) @ 100° F (37.8°C).
Pressure Drop	< 0.1 psi at 12 ft/s in 4" (101.6 mm) and larger pipe.
Outputs	(1) Analog: 4 to 20 mA, 0 to 5 V, 0 to 10 V or 2 to 10 V (display selectable); (1) Pulse/Frequency: 0 to 15 V peak pulse, 0 to 500 Hz or scalable pulse output (display selectable); (2) Alarm: (1) Empty pipe detection or minimum/maximum velocity, (display selectable); (1) Reverse flow output indication.
Power Requirements	12 to 42.4 VDC, 0.25 A @ 24 VDC; 12 to 36 VAC.
Electrical Connection	Removable terminal blocks, model selectable 1/2" female NPT conduit connection, PG 16 gland or PG 16 gland with (2) 10 ft (3 m) 9 conductor 22 AWG plenum rated cables, accessory cable lengths up to 200 ft (61 m) optional.
Display (-LCD option)	2" (5.08 cm) x 2" (5.08 cm) graphic LCD with backlight.
Conductivity	> 20 microsiemens
Enclosure Material	Powder coated die cast aluminum.
Enclosure Ratings	NEMA 6P (IP68) (Non display models); NEMA 4X (IP66) (-LCD option).
Agency Approvals	BTL, CE, NSF/ANSI 61 and 372 pending.

COMMUNICATIONS SPECIFICATIONS (-COM OPTION)

Type	BACnet MS/TP or Modbus® RTU communication protocol (default disabled, display selectable).
Supported Baud Rates	9600, 19200, 38400, 57600, 76800, or 115200 bps (display selectable).
Device Load	1/8 unit load.

ADDITIONAL SPECIFICATIONS

Applicable Pipe Material	BACnet MS/TP or Modbus® RTU communication protocol (default disabled, display selectable).
Applicable Pipe Size	9600, 19200, 38400, 57600, 76800, or 115200 bps (display selectable).
Diameter Length Requirements	1/8 unit load.
*For max flowrates > 10 ft/s (3 m/s) order option -CC.	



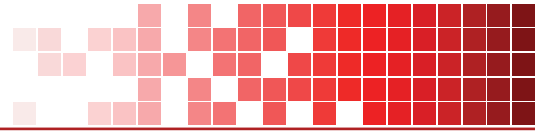

DIMENSIONS

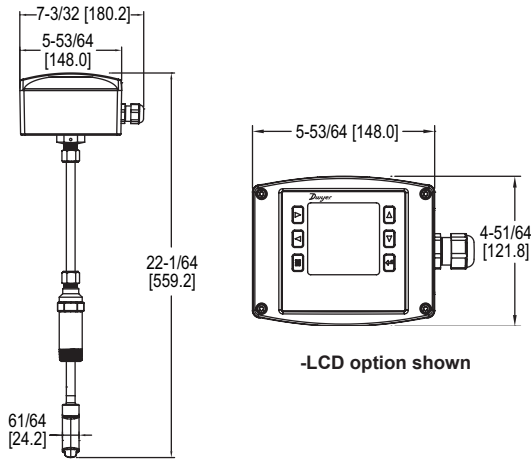

WIRING DIAGRAM

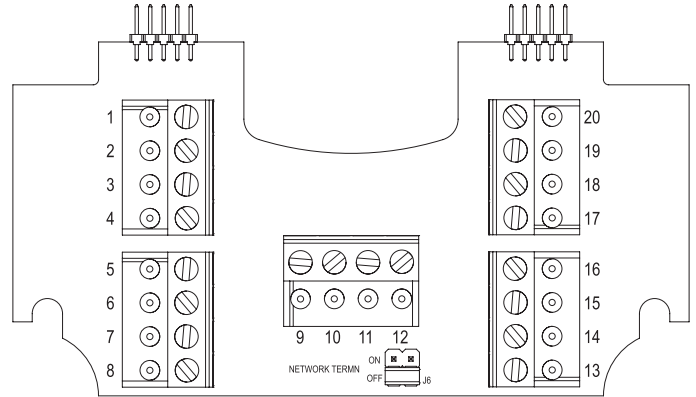

WIRING DIAGRAM				
Cable*	Terminal #	Wire Color	Description	Note
A	1	Red	Power Supply Positive	Connect to +24VDC or VAC transformer
A	2	Black	Power Supply Common	Connect to 24VDC/VAC common
A	13	Shield	-	If used - Application Dependant
B	14	Shield	-	If used - Application Dependant
External	-	-	Earth/Chassis Ground	-
Analog Current Output				
B	3	Brown	(+) Analog current output	4 to 20 mA process output
B	4	Blue	(-) Analog output common	Current output common
Analog Voltage Output				
B	5	Green	(+) Analog voltage output	May be configured; 0 to 10 V, 0 to 5 V, 2 to 10 V, etc.
B	6	White	(-) Analog output common	Voltage output common
Frequency Output				
B	8	Violet	(+) Frequency output	0 to 500 Hz output (@ 0/15 VDC output level)
B	7	Grey	(-) Analog output common	Frequency output common
RS-485 Communication (optional)				
B	11,12	Orange	RS-485 (+)	On board short for daisy chain connection
B	9,10	Yellow	RS-485 (-)	On board short for daisy chain connection
Reverse Flow				
A	15	Brown	Isolated solid state output N.O.	50 V AC/VDC @ 100 mA maximum
A	16	Blue	Isolated solid state output N.O.	50 V AC/VDC @ 100 mA maximum
Alarm				
A	17	Green	Isolated solid state output N.O.	50 V AC/VDC @ 100 mA maximum
A	18	White	Isolated solid state output N.O.	50 V AC/VDC @ 100 mA maximum
Pulse				
A	19	Orange	Isolated solid state output N.O.	50 V AC/VDC @ 100 mA maximum
A	20	Yellow	Isolated solid state output N.O.	50 V AC/VDC @ 100 mA maximum
No Connection				
B	-	Red	Do not connect	-
B	-	Black	Do not connect	-
A	-	Violet	Do not connect	-
A	-	Grey	Do not connect	-

*Supplied cables - shown



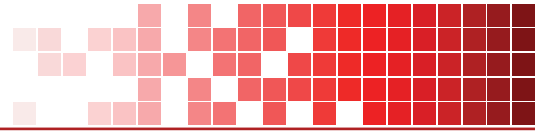

HOW TO ORDER

Use the **bold** characters from the chart below to construct a product code.

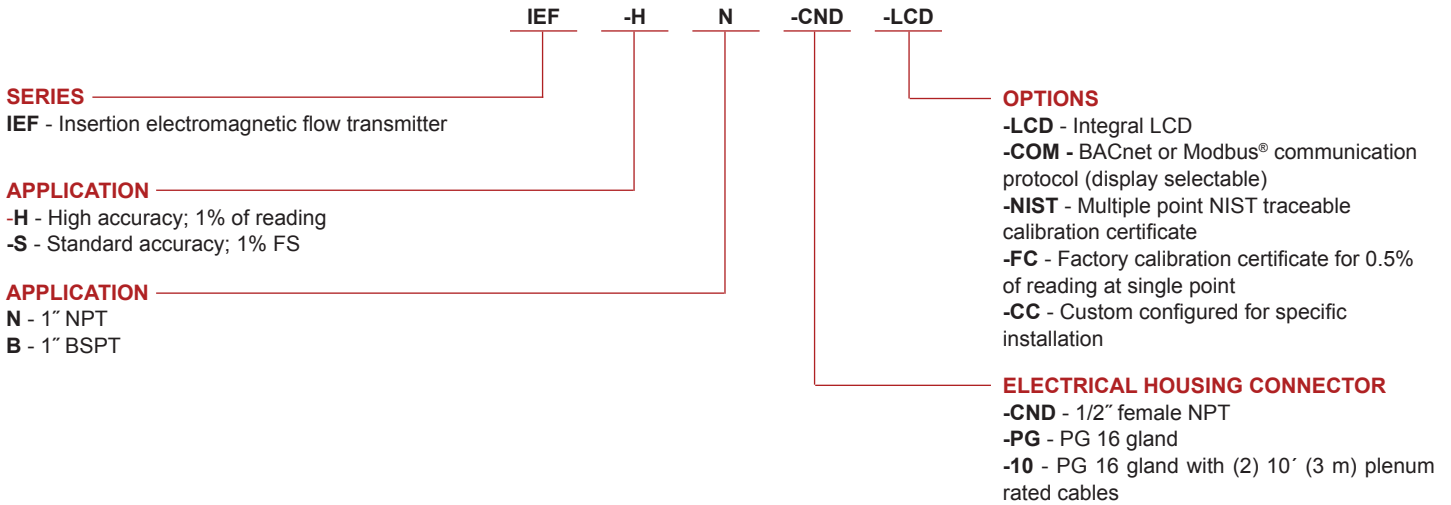

ACCESSORIES

Model	Description
A-IEF-KIT	Setup kit (includes setup display, thickness gage and measuring tape)
A-IEF-DSP	Setup display
A-IEF-CBL-50	Plenum rated cable 50 ft (15.2 m)
A-IEF-VLV-BR	1-1/4" full port isolation valve brass
A-IEF-VLV-SS	1-1/4" full port isolation valve 316 SS
A-IEF-INGD	Installation alignment kit
A-IEF-PA	AC wall adapter

Modbus® is a registered trademark of Schneider Automation, Inc.

Important Notice: Dwyer Instruments, Inc. reserves the right to make changes to or discontinue any product or service identified in this publication without notice. Dwyer advises its customers to obtain the latest version of the relevant information to verify, before placing any orders, that the information being relied upon is current.



INSERTION ELECTROMAGNETIC FLOW TRANSMITTER

Field Configurable, High Accuracy, BACnet or Modbus® Protocol



Shown with A-IEF-VLV-BR accessory valve

-LCD option shown

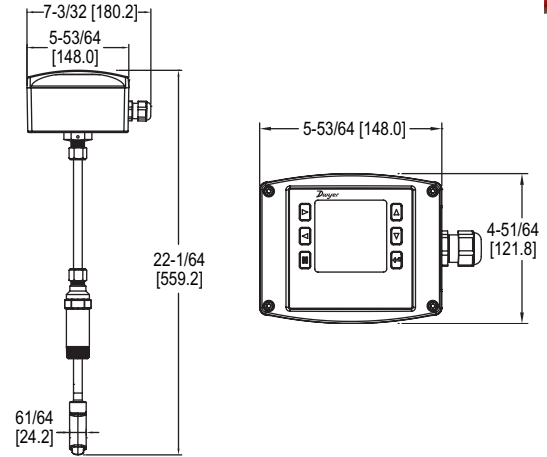

The **SERIES IEF** Insertion Electromagnetic Flow Transmitter is an adjustable insertion flowmeter featuring electromagnetic technology that accurately and reliably measures fluid velocity in addition to providing several continuous signal outputs. This series is specifically designed to offer superior performance paired with simple installation and use. One unit is adjustable to fit pipe sizes from 4 to 36" (102 to 914 mm), and offers several output options including selectable BACnet MS/TP or Modbus® RTU communications protocol over 2-wire RS-485 in addition to the standard analog, frequency and alarm outputs.

FEATURES/BENEFITS

- Field configurable setup displays (-LCD integral option or remote accessory A-IEF-DSP) allow for ultimate flexibility by accommodating a variety of application configurations with one model through multiple display configurations i.e. pipe size, pipe material, liquid type, analog output, pulse/frequency output, alarm outputs, communication outputs, damping, and calibration factor.
- High performance accuracy is maintained through changes in temperature, density or viscosity.
- Setup Wizard and installation tool are simple to use allowing for quick and precise installation.
- Accessory setup kit A-IEF-KIT ensures exact installation application depth with included thickness gage and measuring tape.
- Long Life Cycle and minimal maintenance requirements with no moving parts to wear or break and electrodes that discourage fouling.
- Isolation valve accessory options allow for installation in operational systems via hot-tap kit or easy removal without system downtime.
- NIST calibration certificate included standard for Carbon Steel Schedule 40 pipes sized 4" (102 mm), 6" (150 mm), 8" (200 mm), and 10" (250 mm) with high accuracy option.

APPLICATIONS

- Boiler feed water
- Chilled water
- Open and closed loop condenser water
- Irrigation system
- Municipal water distribution
- Process and coolant flow
- Ground water remediation
- Chemical processing
- Pump protection
- Wastewater
- Mining

MODEL CHART

Example	IEF	-H	N	-CND	-LCD	IEF-HN-CND-LCD
Series	IEF					Insertion electromagnetic flow transmitter
Accuracy		H S				High accuracy; 1% of reading Standard accuracy; 1% FS
Process Connection			N B			1" NPT 1" BSPT
Electrical Housing Connector				CND PG 10		1/2" female NPT PG 16 gland PG 16 gland with (2) 10' (3 m) plenum rated cables
Options					LCD COM NIST FC CC	Integral LCD BACnet or Modbus® communication protocol (display selectable) Multiple point NIST traceable calibration certificate Factory calibration certificate for 0.5% of reading at single point Custom configured for specific installation

SPECIFICATIONS

Service: Compatible clean or dirty non coating, conductive liquids.
Range: 0 to 20 ft/s (0 to 6 m/s).*
Wetted Materials: Body shaft/fitting: 316SS; Electrodes: 316SS; Electrode cap: Polymer/Polystyrene; O-ring: Silicon.
Accuracy: IEF-HX-X: ±0.5% of reading at calibrated velocity; ±1% of reading from 2 to 20 ft/s (0.6 to 6 m/s); ±0.02 ft/s (±0.006 m/s) at < 2 ft/s (0.6 m/s). IEF-SX-X: ±1% FS.
Temperature Limits: Ambient: -20 to 160°F (-29 to 71°C); Process: 15 to 250°F (121°C); Storage: -40 to 185°F (-40 to 85°C).
Process Connection: 1" NPT or BSPT with accessory full port ball valve options.
Pressure Limits: 400 psi (27.6 bar) @ 100° F (37.8°C).
Pressure Drop: < 0.1 psi at 12 ft/s in 4" (101.6 mm) and larger pipe.
Outputs:
 (1) Analog: 4 to 20 mA, 0 to 5 V, 0 to 10 V or 2 to 10 V (display selectable);
 (1) Pulse/Frequency: 0 to 15 V peak pulse, 0 to 500 Hz or scalable pulse output (display selectable);
 (2) Alarm: (1) Empty pipe detection or minimum/maximum velocity, (display selectable); (1) Reverse flow output indication.
Power Requirements: 12 to 42.4 VDC, .25 A @ 24 VDC; 12 to 36 VAC.
Electrical Connection: Removable terminal blocks, model selectable 1/2" female NPT conduit connection, PG 16 gland or PG 16 gland with (2) 10 ft (3 m) 9 conductor 22 AWG plenum rated cables, accessory cable lengths up to 200 ft (61 m) optional.
Display (-LCD option): 2" (5.08 cm) x 2" (5.08 cm) graphic LCD with backlight.
Conductivity: >20 microsiemens.
Enclosure Material: Powder coated die cast aluminum.
Enclosure Ratings: NEMA 6P (IP68) (Non display models); NEMA 4X (IP66) (-LCD option).
Agency Approvals: BTL, CE, NSF/ANSI 61 and 372 pending.

COMMUNICATIONS (-COM OPTION)

Type: BACnet MS/TP or Modbus® RTU communication protocol (default disabled, display selectable).
Supported Baud Rates: 9600, 19200, 38400, 57600, 76800, or 115200 bps (display selectable).
Device Load: 1/8 unit load.

ADDITIONAL SPECIFICATIONS

Applicable Pipe Material: Most popular plastic and metal pipes; i.e. Carbon steel, SS, copper, UPVC/PVDF, galvanized steel, mild steel, and brass.
Applicable Pipe Size: IEF-HX-X: 4 to 10" (101 to 254 mm); IEF-SX-X: 4 to 36" (101 to 914 mm).
Diameter Length Requirements: >10' upstream, >5' downstream.
 *For max flowrates >10 ft/s (3 m/s) order option -CC.

ACCESSORIES

Model	Description
A-IEF-KIT	Setup kit (includes setup display, thickness gage and measuring tape)
A-IEF-DSP	Setup display
A-IEF-CBL-50	Plenum rated cable 50 ft (15.2 m)
A-IEF-VLV-BR	1-1/4" full port isolation valve brass
A-IEF-VLV-SS	1-1/4" full port isolation valve 316SS
A-IEF-INGD	Installation alignment kit
A-IEF-PA	AC wall adapter

Flow Transmitters, Electromagnetic, Adjustable Insertion



Series IEF Insertion Electromagnetic Flow Transmitter

Specifications - Installation and Operating Instructions



-LCD option shown

Shown with A-IEF-VLV-BR
accessory valve

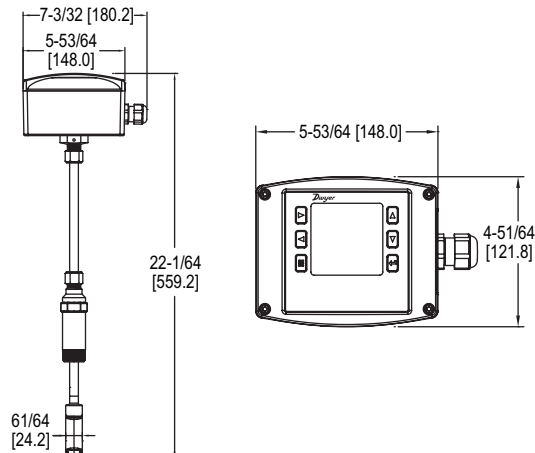

The **SERIES IEF** Insertion Electromagnetic Flow Transmitter is an adjustable insertion flowmeter featuring electromagnetic technology that accurately and reliably measures fluid velocity in addition to providing several continuous signal outputs. This series is specifically designed to offer superior performance paired with simple installation and use. One unit is adjustable to fit pipe sizes from 4 to 36" (102 to 914 mm), and offers several output options including selectable BACnet MS/TP or Modbus® RTU communications protocol over 2-wire RS-485 in addition to the standard analog, frequency and alarm outputs.

FEATURES/BENEFITS

- Field configurable setup displays (-LCD integral option or remote accessory A-IEF-DSP) allow for ultimate flexibility by accommodating a variety of application configurations with one model through multiple display configurations i.e. pipe size, pipe material, liquid type, analog output, pulse/frequency output, alarm outputs, communication outputs, damping, and calibration factor.
- High performance accuracy is maintained through changes in temperature, density or viscosity.
- Setup Wizard and installation tool are simple to use allowing for quick and precise installation.
- Accessory setup kit A-IEF-KIT ensures exact installation application depth with included thickness gage and measuring tape.
- Long Life Cycle and minimal maintenance requirements with no moving parts to wear or break and electrodes that discourage fouling.
- Isolation valve accessory options allow for installation in operational systems via hot-tap kit or easy removal without system downtime.
- NIST calibration certificate included standard for Carbon Steel Schedule 40 pipes sized 4" (102 mm), 6" (150 mm), 8" (200 mm), and 10" (250 mm) with high accuracy option.

APPLICATIONS

- Boiler feed water
- Chilled water
- Open and closed loop condenser water
- Irrigation system
- Municipal water distribution
- Process and coolant flow
- Ground water remediation
- Chemical processing
- Pump protection
- Wastewater
- Mining

SPECIFICATIONS

Service: Compatible clean or dirty non coating, conductive liquids.

Range: 0 to 20 ft/s (0 to 6 m/s).*

Wetted Materials: Body shaft/fitting: 316SS; Electrodes: 316SS; Electrode cap: Polymer/Polystyrene; O-ring: Silicone.

Accuracy: IEF-HX-X: $\pm 0.5\%$ of reading at calibrated velocity; $\pm 1\%$ of reading from 2 to 20 ft/s (0.6 to 6 m/s) ± 0.02 ft/s (± 0.006 m/s) at < 2 ft/s (0.6 m/s). IEF-SX-X: $\pm 1\%$ FS.

Temperature Limits: Ambient: -20 to 160°F (-29 to 71°C); Process: 15 to 250°F (-9 to 121°C); Storage: -40 to 185°F (-40 to 85°C).

Process Connection: 1" NPT or BSPT with accessory full port ball valve options.

Pressure Limits: 400 psi (27.6 bar) @ 100°F (37.8°C).

Pressure Drop: < 0.1 psi at 12 ft/s in 4" (101.6 mm) and larger pipe.

Outputs:

- (1) Analog: 4 to 20 mA, 0 to 5 V, 0 to 10 V or 2 to 10 V (display selectable);
- (1) Pulse/Frequency: 0 to 15 V peak pulse, 0 to 500 Hz or scalable pulse output (display selectable);
- (2) Alarm: (1) Empty pipe detection or minimum/maximum velocity, (display selectable); (1) Reverse flow output indication.

Power Requirements: 12 to 42.4 VDC, .25 A @ 24 VDC; 12 to 36 VAC.

Electrical Connection: Removable terminal blocks, model selectable 1/2" female NPT conduit connection, PG 16 gland or PG 16 gland with (2) 10 ft (3 m) 9 conductor 22 AWG plenum rated cables, accessory cable lengths up to 200 ft (61 m) optional.

Display (-LCD option): 2" (5.08 cm) x 2" (5.08 cm) graphic LCD with backlight.

Conductivity: > 20 microsiemens.

Enclosure Material: Powder coated die cast aluminum.

Enclosure Ratings: NEMA 6P (IP68) (Non display models); NEMA 4X (IP66) (-LCD option).

Agency Approvals: BTL, CE, NSF/ANSI 61 and 372 pending.

COMMUNICATIONS (-COM OPTION)

Type: BACnet MS/TP or Modbus® RTU communication protocol (default disabled, display selectable).

Supported Baud Rates: 9600, 19200, 38400, 57600, 76800, or 115200 bps (display selectable).

Device Load: 1/8 unit load.

ADDITIONAL SPECIFICATIONS

Applicable Pipe Material: Most popular plastic and metal pipes; i.e. Carbon steel, SS, copper, UPVC/PVDF, galvanized steel, mild steel, and brass.

Applicable Pipe Size: IEF-HX-X: 4 to 10" (101 to 254 mm); IEF-SX-X: 4 to 36" (101 to 914 mm).

Diameter Length Requirements: > 10 upstream, > 5 downstream.

*For max flowrates > 10 ft/s (3 m/s) order option -CC.

Modbus® is a registered trademark of Schneider Automation, Inc.

MODEL CHART						
Example	IEF	-H	N	-CND	-LCD	IEF-HN-CND-LCD
Series	IEF					Insertion electromagnetic flow transmitter
Accuracy		H S				High accuracy; 1% of reading Standard accuracy; 1% FS
Process Connection			N B			1" NPT 1" BSPT
Electrical Housing Connector				CND PG 10		1/2" female NPT PG 16 gland PG 16 gland with (2) 10' (3 m) plenum rated cables
Options					LCD COM NIST FC CC	Integral LCD BACnet or Modbus® communication protocol (display selectable) Multiple point NIST traceable calibration certificate Factory calibration certificate for 0.5% of reading at single point Custom configured for specific installation

ACCESSORIES	
Model	Description
A-IEF-KIT	Setup kit (includes setup display, thickness gage and measuring tape)
A-IEF-DSP	Setup display
A-IEF-CBL-50	Plenum rated cable 50 ft (15.2 m)
A-IEF-VLV-BR	1-1/4" full port isolation valve brass
A-IEF-VLV-SS	1-1/4" full port isolation valve 316SS
A-IEF-INGD	Installation alignment kit
A-IEF-PA	AC wall adapter

Safety Information

WARNING

- Only qualified professionals equipped with the necessary required trade skills should install, remove or service this product in any way. Failure to follow the proper installation procedures could lead to death or permanent injury.
- This product is intended to be installed in pressurized pipe applications. In this event, product will be under pressure, caution should be taken to properly vent system prior to installation or removal of the unit. Failure to do so could result in equipment damage and/or serious bodily injury.

CAUTION

- Refer to Model Chart and Specifications for the applicable options to your unit.
- Ensure the unit is sufficiently grounded as stated in this bulletin.
- Depressurize and vent systems without Hot-tap valve prior to installation or removal.
- Confirm the Series IEF wetted material is chemically compatible with process media prior to installation and use.
- Do not exceed maximum temperature and pressure specifications.
- Wear appropriate personal protective equipment during installation, removal and or service of the unit.
- Altering the product construction in any way may adversely affect product operation and voids warranty.
- Prior to attempting to wire or service the Series IEF disconnect from power.

OPERATING PRINCIPLE

- Per Faraday's Law of electromagnetic induction, a voltage is induced in a conductor when it passes through a magnetic field, and the induced voltage will be directly proportional to the velocity of the conductor.
- The Series IEF Flow Transmitter generates pulsating magnetic fields in the probe to induce a voltage into a conductive fluid flowing through the pipe.
- Electrodes located on the probe measure the induced voltage. Electronics and firmware within the enclosure convert the voltage to velocity and flow rate while using various outputs to convey the data to connected systems (i.e. display devices, data acquisition systems, or BTU meters).

INCLUDED WITH THE FLOWMETER

Carefully unpack the shipping container of your new Series IEF Insertion Electromagnetic Flow Transmitter and remove the following items:

- (1) Series IEF Insertion Electromagnetic Flow Transmitter
- (1) A-IEF-INGD Installation Alignment Kit:
 - (1) Alignment Scale
 - (2) Alignment Rods
 - (2) Thumbscrews
- (1) 3 mm Allen Wrench (not shown)

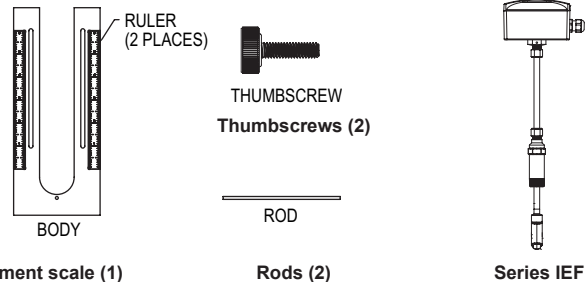

Alignment scale (1)

Rods (2)

Series IEF

Figure 1

RECOMMENDED TOOLS

- (2) 12" (300 mm) adjustable wrenches
- (1) 12" (300 mm) pipe wrench

SETUP

Selecting Installation Location

1. Although the unit may be installed in any orientation, the ideal mounting position is on the side of the pipe (2 o'clock or 10 o'clock position)* as this generally minimizes possible air or sediment interference with the Series IEF. It is not recommended to mount the unit below the pipe (6 o'clock position).

NOTICE

When installing a unit with an integral display select an installation location that allows for clear viewing of the display and proper earth ground.

Insert the IEF in a pipe via a threaded Tee, Saddle, or welded integrally reinforced branch connection outlet fitting.

If a Hot-Tap option is required, use a 1-1/4" valve kit with proper mounting hardware available in Model A-IEF-VLV-BR or A-IEF-VLV-SS. A 1" (25.4 mm) hole in the pipe is required for proper installation.

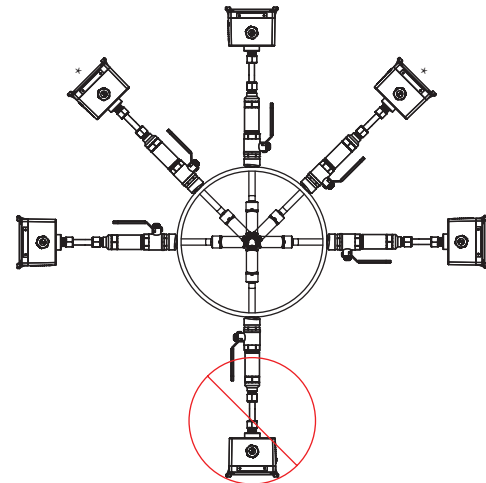

Figure 2

2. Select a location that will minimize flow distortion with adequate upstream and downstream pipe diameters as displayed. Ideal installation will have a minimum of 10 pipe diameters upstream relative to the instrument and a minimum distance of 5 pipe diameters downstream.

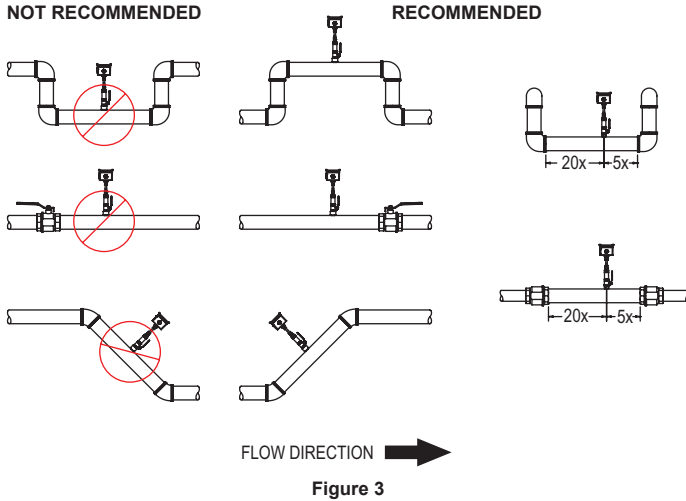

Figure 3

INSTALLATION

1. To prepare the meter for installation, mount the provided alignment scale to the side of the meter with the two provided thumbscrews. The thumbscrews are to be inserted through the alignment scale slots and into the holes in the side of the lid as shown in Figure 4, finger tighten only. Be sure to orient the alignment scale as shown in figure below. Actual scale setting determined in next step.

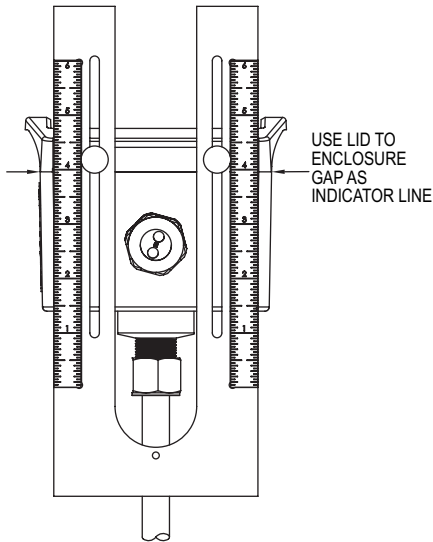

Figure 4

For Custom Configured Models (-CC Option)

2. Locate the configuration tag attached to the Series IEF to identify the value of the alignment scale setting. Position the alignment scale such that the scale setting is lined-up with the seam of the enclosure as shown in Figure 4. Minor scale marks are in 1/20ths. Securely tighten the thumbscrews.
3. Refer to Preparing the Unit for Installation section.

For Field Configurable Models

2. For field configuration, a display is required (-LCD option or accessory A-IEF-DSP) and needs to be powered via normal field wiring or with the AC wall adapter accessory A-IEF-PA (A-IEF-DSP and A-IEF-PA are also available in the accessory setup kit A-IEF-KIT).
3. When using the AC wall adapter and the cable is supplied, connect the red (positive +) and black (common -) wires of the cable bundle marked "A" to the open terminals of the AC wall adapter. This will provide temporary power to the meter to complete the installation set up.
4. For field wiring, refer to the wiring chart tag attached to the Series IEF to identify the terminal block pins for positive (+) and common (-) connection.
5. Unscrew the four captured cover screws using the supplied 3 mm Allen wrench to remove and set aside enclosure cover.
6. Insert one connector of the ribbon cable supplied in the setup kit into the connector labeled "Display" in the middle of the unit. Be sure to orient the keying feature/tab. See Figure 5 below:

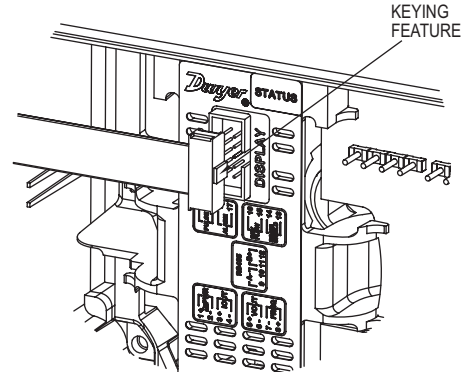

Figure 5

7. Plug the other end of the cable into the bottom of the supplied portable display being sure to orient the keying feature/tab as shown:

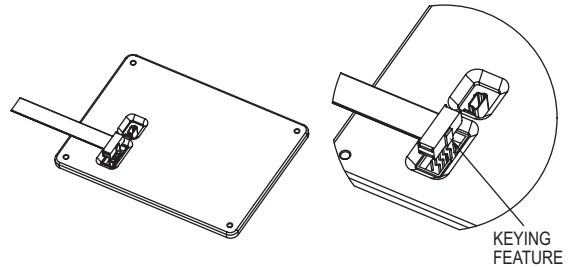

Figure 6

8. Apply power to the unit and the display will turn-on automatically. Follow the on screen directions for entering the necessary parameters to setup the unit and obtain the alignment scale setting value.

NOTICE

Precise pipe measurements are required for high performance installation. The A-IEF-KIT includes setup display A-IEF-DSP, thickness gage UTG and measuring tape A-IEF-MSTP used to obtain these measurements. When the precise pipe measurement information is known select Option 2 High Performance setup in the Install Kit option of the display selection

NOTICE

When using measuring tape A-IEF-MSTP to measure pipe circumference use the 100ths side to measure the circumference of the pipe without insulation.

Preparing the Unit for installation (Refer to Figure 7)

1. Apply appropriate sealant to the process collet (5) threads such as application suitable sealant tape or paste.
2. Install the process collet (5) in valve (6) then tighten by hand.
3. Tighten the process collet (5) with a wrench using the hex geometry until snug.

NOTICE Use two wrenches, one to hold the valve and another wrench to turn the process collet.

4. Slowly open the valve handle (7) checking for leaks.
5. If leaks occur around threaded connections, close the valve and tighten those connections.

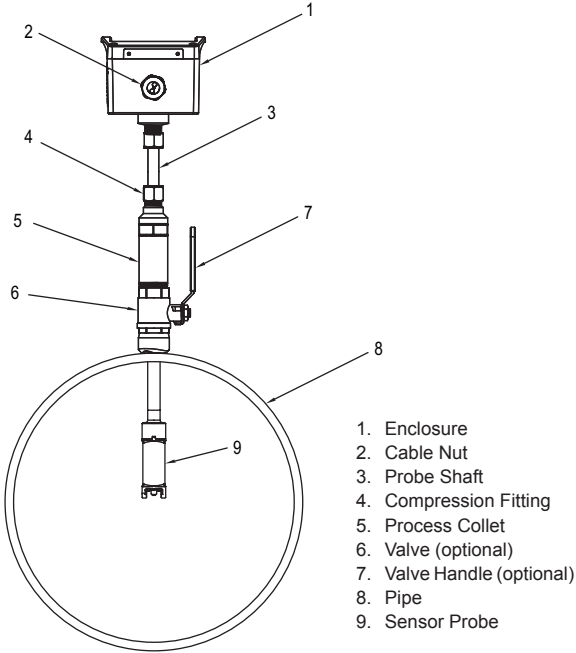

Figure 7

NOTICE Do not adjust housing compression nut at top of probe shaft (3).

Sensor Alignment

A depth and flow alignment installation tool is provided to ensure proper depth insertion and flow alignment. To set the insertion depth verify the alignment scale has not moved from its original setting based on the alignment scale value set previously.

Loosen compression nut (4) to allow the shaft (3) freedom to travel up and down and rotate inside the process collet (5).

Install Depth and Alignment Rods

1. Remove alignment rods from sides of alignment scale by sliding them out.
2. Insert the two rods into the alignment scale as shown.

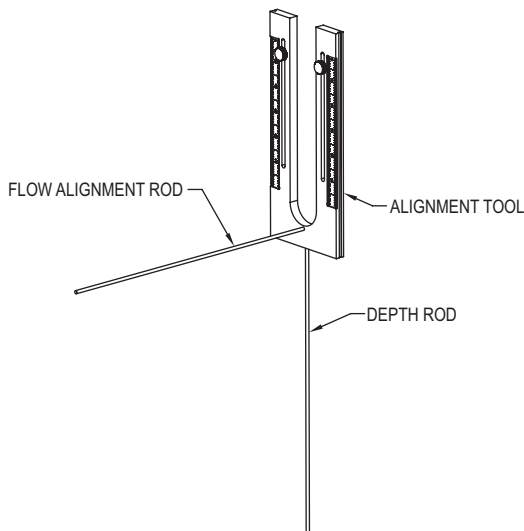

Figure 8

3. Rotate the transmitter so the pipe alignment rod is parallel with the flow in the pipe.

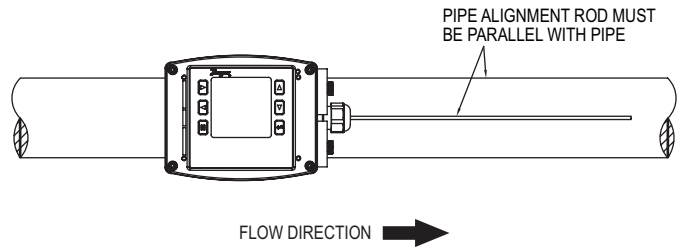

Figure 9

4. Slide the shaft (3) down into the process collet (5) until the depth rod contacts the pipe. If pipe insulation is present press the rod through the insulation.
 - a. Tighten the nut (4) to 15 ft.-lbs (20.3 N m)
 - b. Remove the flow alignment rod and loosen the thumbscrews to slide the alignment tool up to allow removal of the depth alignment rod. Store both rods in the storage slots on the sides of the alignment scale. Tighten thumbscrews and leave alignment tool mounted on unit for storage.

GROUNDING

Metallic Pipe

For proper operation the instrument must be earth grounded. Connect a ground wire to meter housing via the ground lug on the housing collet. Connect the ground wire to a known earth ground. If the pipe is grounded, connect the ground wire to the metal pipe using suitable devices such as grounding clamps.

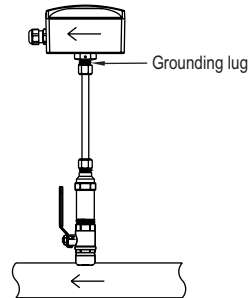

Figure 10

Non-Metallic Pipes

Connect a ground wire to the transmitter housing per the ground lug on the housing collet. Connect the ground wire to a known earth ground. Ground the fluid to earth.

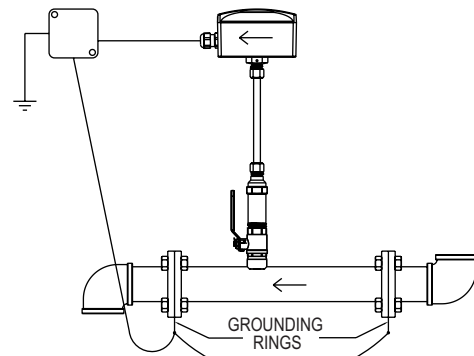

Figure 11

POWER SUPPLY

Choose a power supply with a voltage and current rating sufficient to meet the power specifications under all operating conditions. If the power supply is unregulated, make sure the output voltage remains within the required voltage range under all power line conditions.

WIRING DIAGRAM				
Cable	Terminal #	Wire Color	Description	Note
A	1	Red	Power Supply Positive	Connect to +24VDC or VAC transformer
A	2	Black	Power Supply Common	Connect to 24VDC/VAC common
A	13	Shield	-	If used - Application Dependant
B	14	Shield	-	If used - Application Dependant
External	-	-	Earth/Chassis Ground	-
Analog Current Output				
B	3	Brown	(+) Analog current output	4 to 20 mA process output
B	4	Blue	(-) Analog output common	Current output common
Analog Voltage Output				
B	5	Green	(+) Analog voltage output	May be configured; 0 to 10 V, 0 to 5 V, 2 to 10 V, etc.
B	6	White	(-) Analog output common	Voltage output common
Frequency Output				
B	8	Violet	(+) Frequency output	0 to 500 Hz output (@ 0/15 VDC output level)
B	7	Grey	(-) Analog output common	Frequency output common
RS-485 Communication (optional)				
B	11,12	Orange	RS-485 (+)	On board short for daisy chain connection
B	9,10	Yellow	RS-485 (-)	On board short for daisy chain connection
Reverse Flow				
A	15	Brown	Isolated solid state output N.O.	50 V AC/VDC @ 100 mA maximum
A	16	Blue	Isolated solid state output N.O.	50 V AC/VDC @ 100 mA maximum
Alarm				
A	17	Green	Isolated solid state output N.O.	50 V AC/VDC @ 100 mA maximum
A	18	White	Isolated solid state output N.O.	50 V AC/VDC @ 100 mA maximum
Pulse				
A	19	Orange	Isolated solid state output N.O.	50 V AC/VDC @ 100 mA maximum
A	20	Yellow	Isolated solid state output N.O.	50 V AC/VDC @ 100 mA maximum
No Connection				
B	-	Red	Do not connect	-
B	-	Black	Do not connect	-
A	-	Violet	Do not connect	-
A	-	Grey	Do not connect	-

The Cable column identifying cable A and B is reflective of units that include factory installed cabling.

Wiring PCBA shown in Figure 12 with terminal block numbers as listed in above wiring diagram chart.

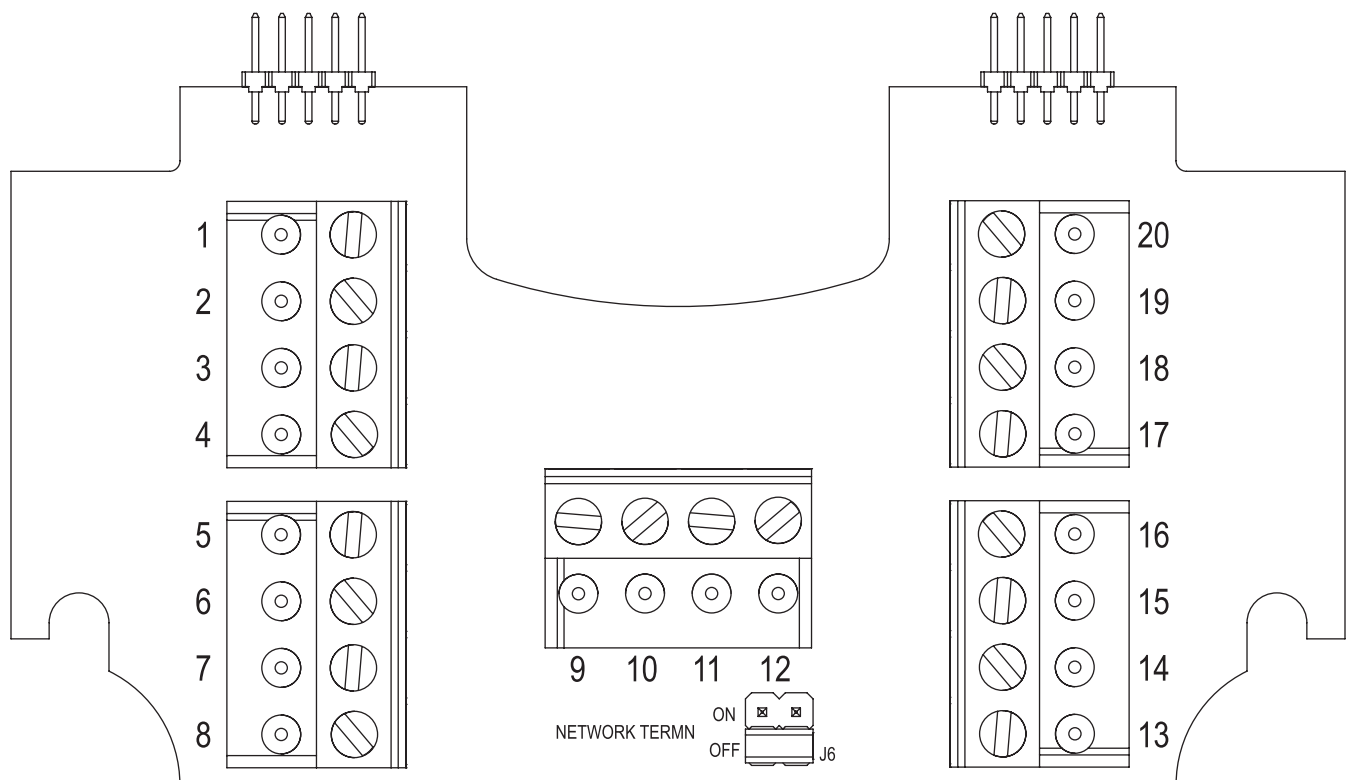

Figure 12

Determining probe insertion depth for models with a display

The Series IEF transmitter will calculate the probe insertion depth used with -LCD display option or A-IEF-DSP display when the steps below are followed.

NOTICE It is recommended to use the A-IEF-KIT which includes a setup display A-IEF-DSP, thickness gage UTG and measuring tape A-IEF-MSTP to obtain these measurements. When the precise pipe measurement information is known, select option 2 (High Performance Setup) under the Install Kit Menu when prompted by the display as shown below. Precise pipe measurements are required for a high performance installation.



1. To measure the pipe circumference remove any existing insulation at the location where the transmitter will be installed. Wrap the tape measure around the pipe to measure the circumference at the selected location using the 100ths side of the tape. Record this measurement for entering into the unit when the circumference measurement is requested.

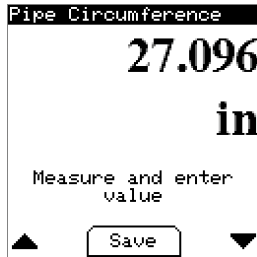

2. To measure the wall thickness of the pipe use the thickness gage UTG. Following the separate directions provided with the UTG gage and record the thickness. This measurement will be needed to enter into the unit after the circumference data is entered.

Follow the on screen directions for entering the circumference and wall thickness dimensions. See the Electronic Control Data Setup section of this manual for more information.

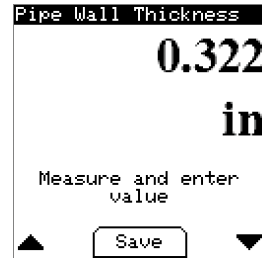

Determining probe insertion depth for models without a display

For models without a display the following formulas allow for calculating the alignment scale value for setting the depth of the probe into the pipe. Also included are wall thickness charts for various pipe materials and sizes.

Pipes <9 in (228.6 mm) diameter: $7.1625 - 1/2 * D - 1.15$

Pipes 10 in (254 mm) diameter: $7.1625 - 1/2 * D$

Pipes 12 in (304.8 mm) to 36 in (914.4 mm): $7.1625 - (0.1 * (D - 2 * WT)) + WT$

Where D represents the pipe outer diameter and WT represents the pipe wall thickness, both in inches. Measurement of the outside diameter and wall thickness can be accomplished as described in the previous section, Determining probe insertion depth for models with a display, or similar method. Precise pipe measurements are required for a high performance installation.

Position the alignment scale such that the alignment scale setting is lined-up with the seam of the enclosure as shown in Figure 13. Minor scale marks are in 1/20ths. Securely tighten the thumbscrews.

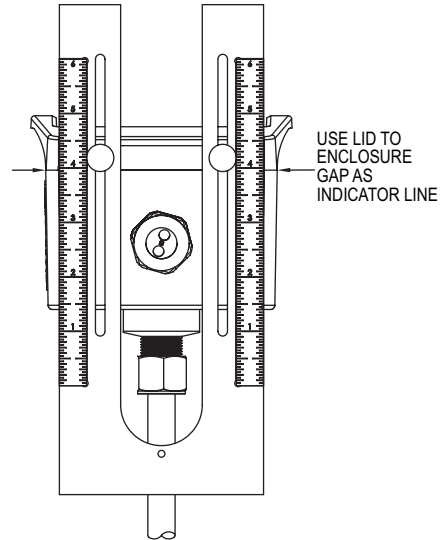

Figure 13

WALL THICKNESS									
Carbon Steel									
Pipe Diameter (in)	DN (mm)	SCH5 (in)	SCH5 (mm)	SCH10 (in)	SCH10 (mm)	SCH40 (in)	SCH40 (mm)	SCH80 (in)	SCH80 (mm)
4.5	114.30	0.083	2.110	0.120	3.050	0.237	6.020	0.337	8.560
5.563	141.30	0.109	2.770	0.134	3.400	0.258	6.550	0.375	9.530
6.625	168.28	0.109	2.770	0.134	3.400	0.280	7.110	0.432	10.970
8.625	219.08	0.109	2.770	0.148	3.760	0.322	8.180	0.500	12.700
10.75	273.05	0.134	3.400	0.165	4.190	0.365	9.270	0.593	15.090
12.75	323.85	0.156	3.960	0.180	4.570	0.406	10.310	0.687	17.480
14	355.60	0.156	3.960	0.250	6.350	0.437	11.130	0.750	19.050
16	406.40	0.165	4.190	0.250	6.350	0.500	12.700	0.843	21.440
18	457.20	0.165	4.190	0.250	6.350	0.562	14.270	0.937	23.830
20	508.00	0.188	4.780	0.250	6.350	0.593	15.090	1.031	26.190
24	609.60	0.218	5.540	0.250	6.350	0.688	17.480	1.218	30.960
32	813.00	0.250	6.350	0.312	7.920	0.688	17.480	1.218	30.960
36	914.40	0.250	6.350	0.312	7.920	0.750	19.050	1.218	30.960

WALL THICKNESS									
Stainless Steel									
Pipe Diameter (in)	DN (mm)	SCH5 (in)	SCH5 (mm)	SCH10 (in)	SCH10 (mm)	SCH40 (in)	SCH40 (mm)	SCH80 (in)	SCH80 (mm)
4.5	114.30	0.083	2.110	0.120	3.050	0.237	6.020	0.337	8.560
5.563	141.30	0.109	2.770	0.134	3.400	0.258	6.550	0.375	9.525
6.625	168.28	0.109	2.770	0.134	3.400	0.280	7.110	0.432	10.970
8.625	219.08	0.109	2.770	0.148	3.760	0.322	8.180	0.500	12.700
10.75	273.05	0.134	3.400	0.165	4.190	0.365	9.270	0.500	12.700
12.75	323.85	0.156	3.960	0.180	4.570	0.375	9.525	0.500	12.700
14	355.60	0.156	3.960	0.188	4.780	0.375	9.525	0.500	12.700
16	406.40	0.165	4.190	0.188	4.780	0.375	9.525	0.500	12.700
18	457.20	0.165	4.190	0.188	4.780	0.375	9.525	0.500	12.700
20	508.00	0.188	4.780	0.218	5.540	0.375	9.525	0.500	12.700
24	609.60	0.218	5.540	0.250	6.350	0.375	9.525	0.500	12.700
32	813.00	0.250	6.350	0.312	7.920	0.375	9.525	0.500	12.700
36	914.40	0.250	6.350	0.312	7.920	0.375	9.525	0.500	12.700

WALL THICKNESS							
Copper							
Pipe Diameter (in)	DN (mm)	Type K		Type L		Type M	
		in	mm	in	mm	in	mm
4.125	104.78	0.134	3.400	0.114	2.895	0.095	2.413
5.125	130.18	0.160	4.064	0.125	3.175	0.109	2.768
6.125	155.58	0.192	4.876	0.140	3.556	0.122	3.098
8.125	206.38	0.271	6.883	0.200	5.080	0.170	4.318
10.25	257.18	0.341	8.661	0.356	9.042	0.308	7.823
12.25	307.98	0.411	10.439	0.411	10.439	0.356	9.042
14	355.60	0.471	11.963	0.459	11.658	0.398	10.109
16	406.40	0.471	11.963	0.459	11.658	0.398	10.109
18	457.20	0.541	13.741	0.513	13.030	0.445	11.303
20	508.00	0.610	15.494	0.568	14.427	0.493	12.522
24	609.60	0.680	17.272	0.623	15.824	0.541	13.741
32	813.00	0.818	20.777	0.732	18.593	0.636	16.154
36	914.40	1.096	27.838	0.950	24.130	0.826	20.980

WALL THICKNESS					
PVC					
Pipe Diameter (in)	DN (mm)	SCH40		SCH80	
		in	mm	in	mm
4.5	114.00	0.237	6.020	0.337	8.560
5.563	141.00	0.258	6.550	0.375	9.520
6.625	168.00	0.280	7.110	0.432	11.000
8.625	219.00	0.322	8.180	0.500	12.700
10.75	273.00	0.365	9.270	0.593	15.100
12.75	324.00	0.406	10.300	0.687	17.400
14	356.00	0.437	11.100	0.750	19.000
16	406.00	0.500	12.700	0.843	21.400
18	457.20	0.562	14.274	0.937	23.800
20	508.00	0.593	15.062	1.031	26.187
24	609.60	0.687	17.450	1.218	30.937
32	813.00	0.874	22.200	1.572	39.929
36	914.40	0.968	24.587	1.754	44.552

Printing out configuration values

After installation is complete a table of configuration values can be gathered from the transmitter to print out and insert into one of the hanging plastic envelopes for future reference. The housing cover/display needs to be removed for access to the display port to retrieve the table of configuration values. To do so:

1. Unscrew the four captured cover screws using the supplied 3 mm Allen wrench to remove the enclosure cover. Leave the display cable connected to the main unit.
2. Insert a customer supplied mini-USB cable into the USB connector on the bottom side of the display PCB.
3. Connect the other end into a standard USB port in a laptop.
4. The Series IEF transmitter will appear as a standard USB drive on the laptop.
5. The file name with the configuration values is in the format of: serial number.txt. The serial number can be found on the product label on the side of the transmitter.
6. Print out the configuration values and insert into one of the hanging plastic envelopes for future reference
7. Re-attach the housing cover/display by reinserting the four 3 mm screws.

CONFIGURATION DATA PRINT OUT EXAMPLE
[Device Information]
MeterTag=Series IEF
SerialNumber=Andrew2
ModelNumber=IEF-XX-COM-LCD
DateCode=20180101
[Setup Information]
CalibratedBy=
Date=
Units=English
VelocityUnit=ft/s
FlowUnit=ft ³ /s
VolumeUnit=gal
[Pipe Configuration]
LiquidType=Water
PipeMaterial=Carbon Steel
PipeCircumference=27.096 in
PipeWallThickness=0.322 in
AlignmentScaleValue=1.85
[Analog Output]
AnalogOutputType=Current 4-20mA
AnalogOutputVariable=Velocity ft/s
AnalogOutputHigh=20.00
AnalogOutputLow=0.00
[Pulse/Freq. Output Setup]
Pulse/Freq. Output=Disabled
[Alarm Output Setup]
AlarmOutput=Empty Pipe Alarm
[Communication]
CommunicationProtocol=Disabled

Removing Series IEF Transmitter

1. To remove the transmitter from an installation without a valve depressurize the pipe and skip to step 4. If installed with a valve loosen compression fitting (4) and withdraw the transmitter shaft fully through the valve until it stops.
2. Tighten compression fitting (4) snug.
3. Close valve (6) via valve handle (7).
4. Remove transmitter by unscrewing process collet (5) from valve (6).

CAUTION Be sure to support the housing end of the transmitter to prevent it from flipping while unscrewing process collet (5) as damage may occur to the probe fins.

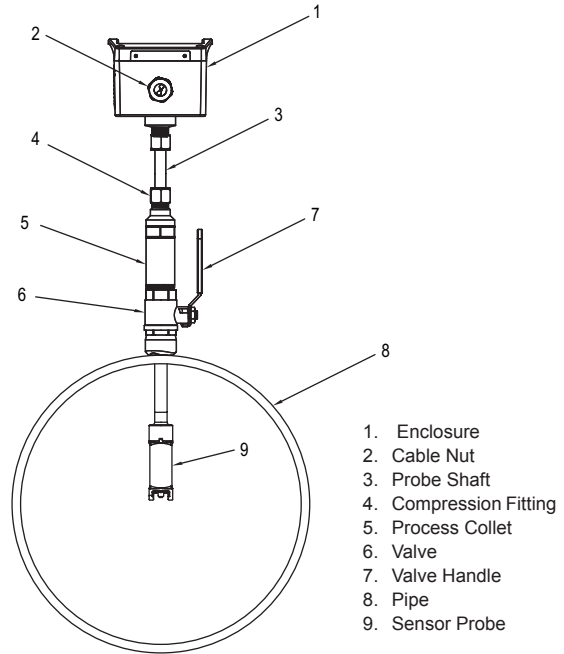

Figure 14

Network Termination Jumper

On the terminal block PCBA there is a jumper, J1 (see Figure 15), that enables or disables a network termination resistor as defined below:

When the network jumper is placed in the ON position there is a 120 ohm termination resistor in place. When the network jumper is placed in the OFF position there is no termination resistor in place.

Default: OFF

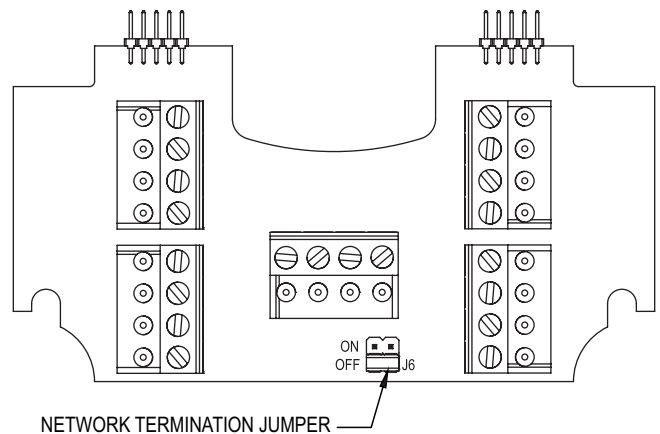

Figure 15

Communication Overview

The Insertion Magmeter supports BACnet MS/TP and Modbus® RTU over 2-wire RS-485.

Selection of protocol and configuration of serial parameters require the use of the display.

BACNET

BACnet Object Overview

Supported BACnet Objects

Object Type	Dynamically Creatable	Dynamically Creatable	Object Identifier	Object Name
Device	No	No	607xxx	Series IEF 607xxx
Analog Input	No	No	A11	Velocity
Analog Value	No	No	AV1	Flow
			AV2	Total Flow
Binary Value	No	No	BV1	Reverse Flow
			BV2	Empty Pipe
			BV3	Reset Total Flow
BitString Value	No	No	BSV1	Status Flags

BACnet Objects: Device Object

Property	Default Value	Property Data Type	Access
Object Identifier	607xxx	BACnetObjectIdentifier	Read/Write
Object Name	"Series IEF 607xxx"	CharacterString(40)	Read/Write
ObjectType	DEVICE(8)	BACnetObjectType	Read
System Status	Operational(0)	BACnetDeviceStatus	Read
Vendor Name	"Dwyer Instruments, Inc."	CharacterString	Read
Vendor Identifier	607	Unsigned	Read
Model Name	"IEF-HN-10-COM"	CharacterString	Read
Firmware Revision	"x.x.x"	CharacterString	Read
Application Software Version	"x.x"	CharacterString	Read
Location	" "	CharacterString(32)	Read/Write
Description	" "	CharacterString(32)	Read/Write
Protocol Version	1	Unsigned	Read
Protocol Revision	14	Unsigned	Read
Protocol Services Supported	See BACnet Services below	BACnetServicesSupported	Read
Protocol Object Types Supported	See Table Above	BACnetObjectTypesSupported	Read
Object List	See Table Above	BACnetArray	Read
Active COV Subscriptions		List of BACnetCOVSubscription	Read
Maximum APDU Length Accepted	480	Unsigned	Read
Maximum APDU Length Accepted	NO_SEGMENTATION (3)	BACnetSegmentation	Read
APDU Timeout	6000	Unsigned	Read/Write
Number of APDU Retries	3	Unsigned	Read/Write
Max Master	127	Unsigned	Read/Write
Max Info Frames	1	Unsigned	Read
Device Address Binding	Empty	BACnetAddressBinding Unsigned	Read
Database Revision	1	BACnetARRAY[N] of	Read
Property List		BACnetPropertyIdentifier	
Serial Number	"xxxxxxx"	CharacterString	Read

The default object identifier is 607xxx, where xxx is replaced by the MS/TP MAC address set in the Network Address menu. The object identifier value will change as the MS/TP MAC address changes. However, if a specific object identifier is written via BACnet, then that value is stored and changes to the MS/TP MAC address will no longer affect the object identifier.

Similarly, the default object name includes 607xxx. The object name will reflect the current object identifier. If a specific object name is written via BACnet, then that value is stored and changes to the object identifier will no longer affect the object name.

APDU Timeout values are rounded to the nearest second (1000ms). Values less than 500 will be rounded to 0 and Number of APDU Retries will be set to 0.

Analog Input – Velocity

Property	Default Value	Property Data Type	Access
Object Identifier	AI1	BACnetObjectIdentifier	Read
Object Name	"Velocity"	CharacterString	Read
ObjectType	ANALOG_INPUT (0)	BACnetObjectType	Read
Present Value	Current reading	Real	Read
Status Flags	0	BACnetStatusFlags	Read
Event State	NORMAL (0)	BACnetEventState	Read
Reliability	NO_FAULT_DETECTED(0)	BACnetReliability	Read
Out Of Service	FALSE (0)	Boolean	Read/Write
Units	Feet-per-second (76)	BACnetEngineeringUnits	Read/Write
COV Increment	0.5	Real	Read/Write
Property List		BACnetARRAY[N] of BACnetPropertyIdentifier	Read

COV Increment Value

Property	Default Value	Property Data Type	Access
0.5 ft/s	0.1 ft/s	10.0 ft/s	0.1 ft/s

Supported Units:

Feet-per-second (76), Feet-per-minute (77), Meters-per-second (74), Meters-per-minute (163), Meters-per-hour (164), Feet-per-hour (512)*, Feet-per-day (513)*, Meters-per-day (514)*

* Non-Standard BACnet unit

Analog Value – Flow

Property	Default Value	Property Data Type	Access
Object Identifier	AI1	BACnetObjectIdentifier	Read
Object Name	"Flow"	CharacterString	Read
ObjectType	ANALOG_INPUT (0)	BACnetObjectType	Read
Present Value	Current reading	Real	Read
Status Flags	0	BACnetStatusFlags	Read
Event State	NORMAL (0)	BACnetEventState	Read
Reliability	NO_FAULT_DETECTED(0)	BACnetReliability	Read
Out Of Service	FALSE (0)	Boolean	Read/Write
Units	Cubic-feet-per-second (142)	BACnetEngineeringUnits	Read/Write
COV Increment	0.5	Real	Read/Write
Property List		BACnetARRAY[N] of BACnetPropertyIdentifier	Read

COV Increment Value

Property	Default Value	Property Data Type	Access
1.0 ft³/s	0.133 ft³/s	13.3681 ft³/s	0.1 ft³/s

Supported Units:

Cubic-feet-per-second (142), Cubic-feet-per-minute (84), Cubic-feet-per-hour (191), Cubic-feet-per-day (248), US-gallons-per-minute (89), US-gallons-per-hour (192), Liters-per-second (87), Liters-per-minute (88), Liters-per-hour (136), Cubic-meters-per-second (85), Cubic-meters-per-minute (165), Cubic-meters-per-hour (135), US-gallons-per-second (515)*, US-gallons-per-day (516)*, Liters-per-day (517)*, Cubic-meters-per-day (518)*

* Non-Standard BACnet unit

Analog Value – Total Flow

Property	Default Value	Property Data Type	Access
Object Identifier	AV2	BACnetObjectIdentifier	Read
Object Name	"Total Flow"	CharacterString	Read
ObjectType	ANALOG_INPUT (0)	BACnetObjectType	Read
Present Value	Current reading	Real	Read
Status Flags	0	BACnetStatusFlags	Read
Event State	NORMAL (0)	BACnetEventState	Read
Reliability	NO_FAULT_DETECTED(0)	BACnetReliability	Read
Out Of Service	FALSE (0)	Boolean	Read/Write
Units	Cubic-feet (79)	BACnetEngineeringUnits	Read/Write
COV Increment	1.0	Real	Read/Write
Property List		BACnetARRAY[N] of BACnetPropertyIdentifier	Read

COV Increment Value

Property	Default Value	Property Data Type	Access
1.0 ft³/s	0.133 ft³/s	13.3681 ft³/s	0.1 ft³/s

Supported Units:

Cubic-feet (79), US-gallons (83), Liters (82), Cubic-meters (80)

Binary Value – Reverse Flow

Property	Default Value	Property Data Type	Access
Object Identifier	BV1	BACnetObjectIdentifier	Read
Object Name	"Reverse Flow"	CharacterString	Read
ObjectType	BINARY_VALUE (5)	BACnetObjectType	Read
Present Value	Inactive (0)	BACnetBinaryPV	Read
Status Flags	0	BACnetStatusFlags	Read
Event State	NORMAL (0)	BACnetEventState	Read
Reliability	NO_FAULT_DETECTED(0)	BACnetReliability	Read
Out Of Service	FALSE (0)	Boolean	Read/Write
Property List		BACnetARRAY[N] of BACnetPropertyIdentifier	Read

This object provides a simple indication of the direction of process flow. When the process fluid is detected as flowing in the normal direction, the present value will return inactive(0). When the process fluid is detected as flowing in the reverse direction, the present value will return active(1).

This object supports COV subscription to allow a monitoring system to easily detect changes in flow direction.

Binary Value – Empty Pipe

Property	Default Value	Property Data Type	Access
Object Identifier	BV2	BACnetObjectIdentifier	Read
Object Name	"Empty Pipe"	CharacterString	Read
ObjectType	BINARY_VALUE (5)	BACnetObjectType	Read
Present Value	Inactive (0)	BACnetBinaryPV	Read
Status Flags	0	BACnetStatusFlags	Read
Event State	NORMAL (0)	BACnetEventState	Read
Reliability	NO_FAULT_DETECTED(0)	BACnetReliability	Read
Out Of Service	FALSE (0)	Boolean	Read/Write
Property List		BACnetARRAY[N] of BACnetPropertyIdentifier	Read

This object provides a simple indication of an error state where no process flow is in contact with the probe. When the process fluid is detected, the present value will return inactive(0). When the process fluid is not detected, the present value will return active(1).

This object supports COV subscription to allow a monitoring system to easily detect this error condition.

Binary Value – Reset Total Flow

Property	Default Value	Property Data Type	Access
Object Identifier	BV3	BACnetObjectIdentifier	Read
Object Name	"Reset Total Flow"	CharacterString	Read
ObjectType	BINARY_VALUE (5)	BACnetObjectType	Read
Present Value	Inactive (0)	BACnetBinaryPV	Read/Write
Status Flags	0	BACnetStatusFlags	Read
Event State	NORMAL (0)	BACnetEventState	Read
Reliability	NO_FAULT_DETECTED(0)	BACnetReliability	Read
Out Of Service	FALSE (0)	Boolean	Read/Write
Property List		BACnetARRAY[N] of BACnetPropertyIdentifier	Read

Writing a value of 1 to the present value of this object will reset the value of Total Flow to 0. Writing a value of 0 has no effect.

BitString Value – Status Flags

Property	Default Value	Property Data Type	Access
Object Identifier	BSV1	BACnetObjectIdentifier	Read
Object Name	"Status Flags"	CharacterString	Read
ObjectType	BITSTRING_VALUE (39)	BACnetObjectType	Read
Present Value	{FFFFFFFF FFFF}	BitString	Read
Status Flags	0	BACnetStatusFlags	Read
Event State	NORMAL (0)	BACnetEventState	Read
Reliability	NO_FAULT_DETECTED(0)	BACnetReliability	Read
Out Of Service	FALSE (0)	Boolean	Read/Write
Property List		BACnetARRAY[N] of BACnetPropertyIdentifier	Read

This object provides a means for the meter to convey additional error status to a BACnet client. See the table below for a definition of each bit.

Bit	Meaning
0	Error: Reading/Writing Non-volatile storage
1	Reserved
2	Error: Process measurement error
3	Error: Meter recovered from watchdog reset
4	Error: Factory configuration invalid
5	Error: Wiring board not installed/detected
6	Error: Power Supply board not installed/detected
7	Reserved
8	Error: Measurement board not installed/detected
9	Error: Excitation board not installed/detected
10	Error: Calibration Data Invalid
11	Error: Process Temperature Probe Failure

BACnet Services

**ReadProperty (DS-RP-B) ReadPropertyMultiple(DS-RPM-B)
WriteProperty (DS-WP-B) WritePropertyMultiple(DS-WPM-B)**

Device Communication Control Service (DM-DCC-B)

This device supports the Device Communication Control Service BIBB. The optional time duration in minutes is also supported. This device is configured with a password that must be provided to successfully execute this command. The password is "Dwyer".

Reinitialize Device Service (DM-RD-B)

This device supports the Reinitialize Device Service BIBB. The supported device states are COLDSTART and WARMSTART. All other states return error. This device is configured with a password that must be provided to successfully execute this command. The password is "Dwyer".

SubscribeCOV Service (DS-COV-B)

This device supports the SubscribeCOV Service BIBB to allow easy monitoring of input data.

- Up to seven (7) concurrent subscriptions
- Confirmed and Unconfirmed COV Notifications
- Fixed lifetime value up to 86400 seconds (24 hours).
- Indefinite lifetime supported.

MODBUS®

Modbus® Functions

The device supports the following functions

Function Name	Function Code
Read Holding Registers	03
Read Input Registers	04
Write Single Register	06
Write Multiple Registers	16

Modbus® Registers

Input Registers

Register	Description	Data Type	Range
0001	Velocity	32bit Float	
0003	Flow	32bit Float	
0005	Total Flow	32bit Float	
0007	Reverse Flow	Unsigned 16bit Integer	0 – Normal 1 – Reverse
0008	Empty Pipe		
0009 - 0010	Status Flags	Unsigned 16bit Integer	0 – Process detected 1 – Process not detected
8001 - 8016	Model Number		See BACnet BitString Object "Status Flags"
8017 - 8020	Serial Number	Unsigned 16bit Integer	
8021 - 8028	Firmware Version		
8029 - 8032	Date Code	String	"IEF-HN-10-COM"
		String	"xxxxxxx"
		String	"x.x.x"
		String	"xxxxxxx"

The String data type is read as a stream of ASCII characters with the first character sent in the MSB of the first register and the second character sent in the LSB of the first register and so on. If the string is shorter than the allotted size, the remaining bytes will be zero padded.

Holding Registers

Register	Description	Data Type	Range
0001 – 0020	Device Name	String	
0021	Velocity Unit	Unsigned 16bit integer	0 – 7
0022	Flow Unit	Unsigned 16bit integer	0 – 15
0023	Volume Unit	Unsigned 16bit integer	0 – 3
0024	Reset Total Flow	Unsigned 16bit integer	0 or 1
0025	Reset Device	Unsigned 16bit integer	0 or 1

Device Name: A string, up to 40 characters long, that will be displayed on the LCD (if present). When reading or writing, all 20 registers must be requested. Strings less than 40 characters shall be 0 padded.

Velocity Unit: Selects the unit of velocity for the value in the velocity register. See Table 1.

Flow Unit: Selects the unit of flow for the value in the Flow register. See Table 2.

Volume Unit: Selects the unit of volume for the value in the Total Flow register. See Table 3.

Reset Total Flow: When a value of 1 is written to this register, the value in the Total Flow register is reset to 0. Writing a value of 0 has no effect. This register will always return a 0 when read.

Reset Device: When a value of 1 is written to this register, the device will perform a warm reset after 5 seconds. Writing a value of 0 has no effect. This register will always return 0 when read.

TABLE 1: VELOCITY UNIT VALUES	
Value	Unit
*0	Feet-per-second (ft/s)
1	Feet-per-minute (ft/min)
2	Feet-per-hour (ft/hr)
3	Feet-per-day (ft/day)
4	Meters-per-second (m/s)
5	Meters-per-minute (m/min)
6	Meters-per-hour (m/hr)
7	Meters-per-day (m/day)

TABLE 2: FLOW UNIT VALUES	
Value	Unit
*0	Cubic-feet-per-second (ft ³ /s)
1	Cubic-feet-per-minute (ft ³ /min)
2	Cubic-feet-per-hour (ft ³ /hr)
3	Cubic-feet-per-day (ft ³ /day)
4	Gallons-per-second (gal/s)
5	Gallons-per-minute (gal/min)
6	Gallons-per-hour (gal/hr)
7	Gallons-per-day (gal/day)
8	Liters-per-second (L/s)
9	Liters-per-minute (L/min)
10	Liters-per-hour (L/hr)
11	Liters-per-day (L/day)
12	Cubic-meters-per-second (m ³ /s)
13	Cubic-meters-per-minute (m ³ /min)
14	Cubic-meters-per-hour (m ³ /hr)
15	Cubic-meters-per-day (m ³ /day)

TABLE 3: VOLUME UNIT VALUES	
Value	Unit
0	Cubic-feet (ft ³)
*1	Gallons (gal)
2	Liters (L)
3	Cubic-meters (m ³)

* Default unit

Multi-Address Support

Multi-Address support allows a register to be read or written to using different byte orientations specified by the address range. For example, input register 0003 can also be read at 2003, 4003 and 6003 with different byte orientations as listed in Table 7. Registers that do not have multi-address support are only available in Big-Endian byte orientation (Modbus® standard).

	Address Range	Float/32bit Values				16Bit Values	
		Register 1		Register 2		Register 3	
Byte Order		MSB		LSB		MSB	LSB
Big-Endian	1-2000	A	B	C	D	A	B
Byte Swap	2001-4000	B	A	D	C	B	A
Word Swap	4001-6000	C	D	A	B	A	B
Little-Endian	6001-8000	D	C	B	A	B	A

Electronic Control Setup -LCD Display Option or A-IEF-DSP Accessory

Basic information

1. Turn on the power to the Display/Menu.

NOTICE

At power ON, the Dwyer Logo, Serial Number and Firmware Version of the Transmitter is displayed.

2. If a Transmitter is NOT configured, a main configuration wizard starts.
3. If the Transmitter is configured, the process data is displayed.

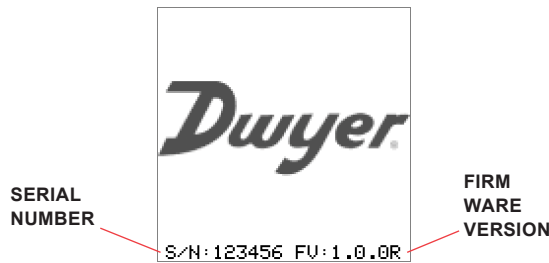

Navigation Basics

1. The UP /DOWN buttons change the selected option or increase or decrease the current value.
2. The RIGHT button advances the display to the next menu without changing the current setting.
3. The LEFT button returns the display to the previous menu without changing the current setting.
4. The ENTER button accepts the selected setting or value and advances to the next menu.
5. The MENU button transitions the display to the main menu. Any unsaved changes will be lost.



Menu Basics

1. Option Menus:
 - The current option is indicated by a highlight bar. The highlight bar is moved with the UP and DOWN buttons.
 - The active option is indicated by an asterisk (*) symbol to the far right of the option name.
2. Value Menus:
 - The active value is always displayed when the menu is displayed.
 - To reset a changed value to the active value, use the LEFT button to return to the previous menu, then the RIGHT button to advance to the value menu again.
3. Press & Hold the UP or DOWN button to continuously increase or decrease the value.
Note: The value will be increased or decreased by a larger amount the longer the button is held.

Main Configuration Wizard

1. Language Selection:

- At the Language Screen elect the Language:

NOTICE

The menu default language is English.

- If necessary, select another language by moving the highlighted bar with the UP /DOWN Arrows and press the Enter Button to select the Language.



2. Unit System Selection Menu:

- This option determines which units will be available in future menus.
- The Default is English
- If necessary, select a different Unit of measure by moving the highlighted bar with the UP /DOWN Arrows and press the Enter button to select the Unit.



3. Velocity Unit Menu:

- This option determines how the calculated volume velocity is displayed.
- The Default is Feet-Per-Second.

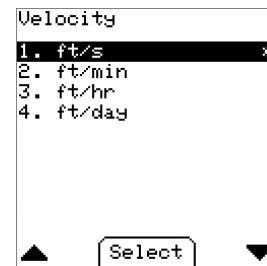

4. Flow Unit Menu:

- This option determines how the calculated volume flow is displayed.
- The Default is Cubic-Feet-Per-Second.

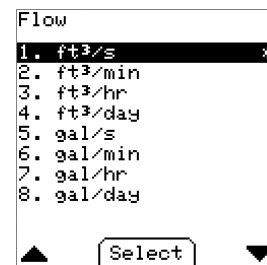

5. Volume Unit Menu:

- This option determines how the totalized flow is displayed.
- The Default is Gallons.

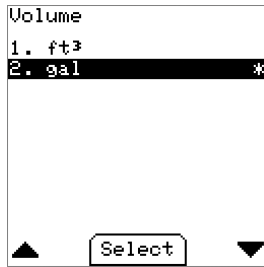

b. Wall Thickness Menu (High Performance):

- This value is the pipe wall thickness where the Transmitter is installed.
- The thickness can be measured with the gauge included in the high performance installation kit.
- Default: 0.322in

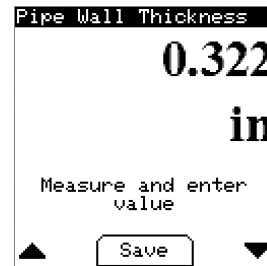

Pipe Configuration Wizard

1. Pipe Material Menu:

- This option helps determine the pipe dimensions as well as account for different material properties.
- The Default is Carbon Steel

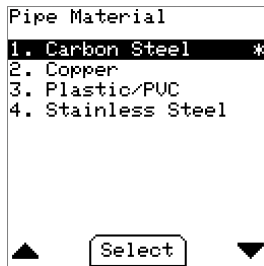

3. Install Kit Menu (Standard):

- Nominal Pipe Size Menu
- Select the diameter of the installation pipe from the list of standard pipe diameters. If your nominal diameter is not listed or you have actual OD data, select Other and enter the pipe diameter directly.
- Default: 8 in

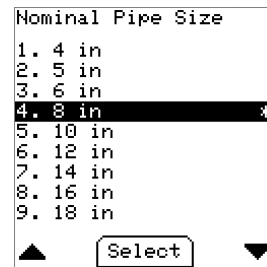

2. Install Kit Menu (High Performance):

- This option determines how the pipe dimensions will be collected.
- If a high accuracy Transmitter was purchased, then a high accuracy installation kit must be used to ensure correctness.
- Default: High Performance Setup.



a. Install Kit Menu (Standard):

- Wall Thickness Menu:
- Select the wall thickness of the installation pipe from the list of standard pipe wall thicknesses.
- If your wall thickness is not listed, select Other and enter the pipe wall thickness directly.
- The options available depend on the pipe material selected.
- Default: Varies with selected pipe material.

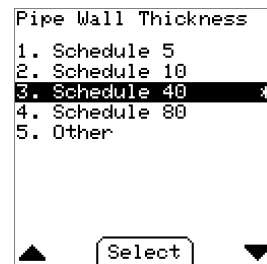

a. Pipe Circumference Menu (High Performance):

- This value is the outside circumference of the pipe where the Transmitter is installed.
- The circumference can be measured with the tape included in the high performance installation kit.
- Default: 27.096in (~8in diameter)

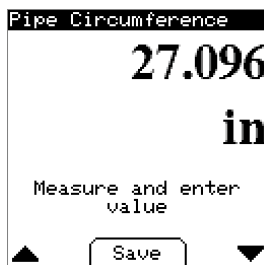

4. Pipe Insertion Depth Display:

- This screen shows the calculated insertion depth based on the values previously entered.
- Using the installation alignment kit provided with the IEF, set the depth to the value displayed:

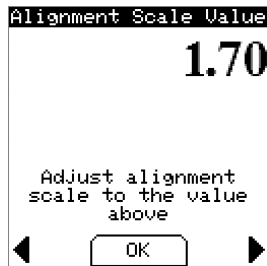
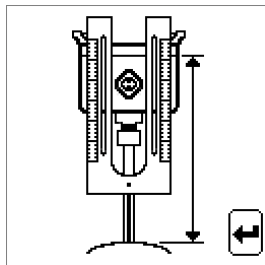

5. Liquid Type Menu:

- This option specifies the process liquid to be measured.
- If Ethylene Glycol is selected, another menu will allow the concentration to be entered.
- Default: Water

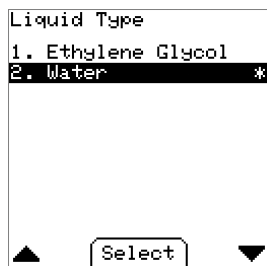

6. Pipe Configuration Summary Display: High Performance:

- This screen shows a summary of the settings entered in the pipe configuration wizard when a high performance installation kit is used.
- High performance Setup

7. Continue to Analog Configuration Wizard Question:

- If Continue is selected, the next menu displayed will be in the Analog configuration wizard.
- If Save & Exit is selected, the settings and values entered during the Pipe configuration wizard will be stored and put into effect.
- Then the display will show process data. Regardless of selection, the ENTER button must be used to choose either option.
- Default: Continue

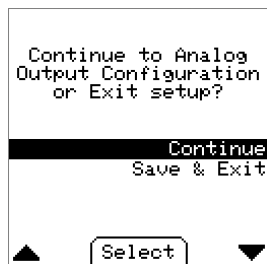

8. Analog Configuration Wizard:

- Analog Output Setup Menu:
- This option determines the type of analog output from the Transmitter.
- Default: Current 4 to 20mA

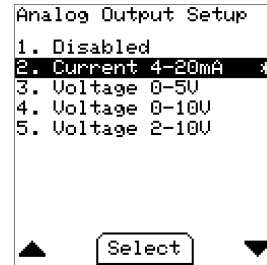

9. Process Variable Menu:

- This option determines which variable is output on the analog signal.
- Default: Velocity

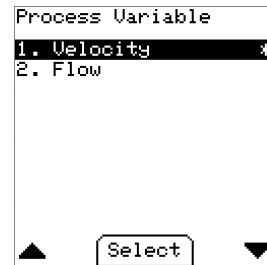

10. Analog Output High Menu:

- This value determines the process value at which the analog output will be at maximum (e.g. 20 mA, 10 V, 5 V).
- Default: 20.0 ft/s.



Standard setup

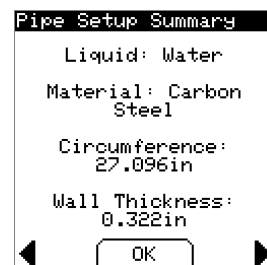

11. Analog Output Low Menu:

- This value determines the process value at which the analog output will be at minimum (e.g. 4mA, 0V).
- Default: 0.0 ft/s

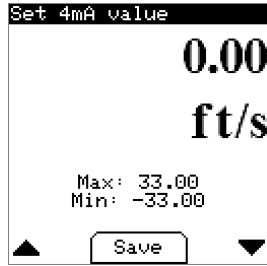

12. Analog Configuration Summary Display:

- This screen shows a summary of the settings entered in the Analog configuration wizard.

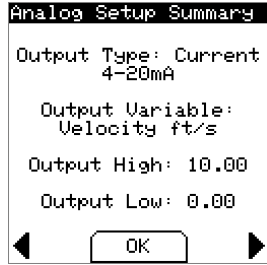

Pulse/Frequency Wizard:

1. Continue to Pulse/Frequency Configuration Wizard Question:

- If Continue is selected, the next menu displayed will be in the Pulse/Frequency configuration wizard.
- If Save & Exit is selected, the settings and values entered during the Analog configuration wizard will be stored and put into effect.
- Then the display will show process data.
- Regardless of selection, the ENTER button must be used to choose either option.
- Default: Continue.

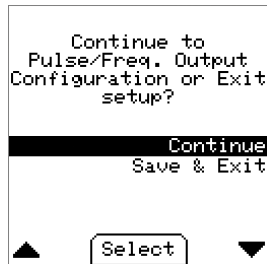

2. Pulse/Frequency Output Menu:

- This option determines the type of digital output from the Transmitter.
- Default: Disabled. If correct press the Enter button.



3. Digital Output: Pulse

• Pulse Scale Menu:

- This value determines the amount to totalized volume between each pulse of the output.
- Default: 7 gallons/pulse

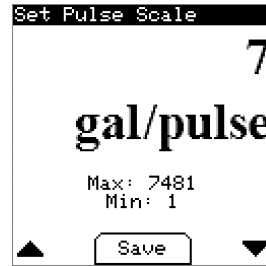

• Pulse Width Menu:

- This value determines the duration of the pulse when active.
- Default: 150 milliseconds

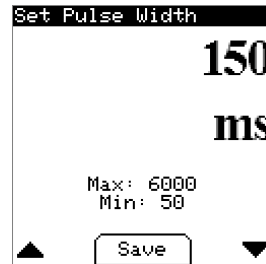

• Pulse/Frequency Summary Display:

- This screen shows a summary of the pulse settings entered in the Pulse/Frequency configuration wizard.

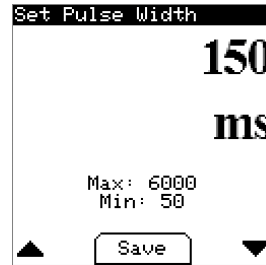

• Frequency Output High Menu:

- This value determines the process value at which the frequency output will be at maximum (500Hz).
- Default: 20.0 ft/s



- Frequency Output Low Menu:
 - This value determines the process value at which the frequency output will be at minimum (0Hz).
 - Default: 0.0 ft/s



4. Pulse/Frequency Summary Display:
 - This screen shows a summary of the frequency settings entered in the Pulse/Frequency configuration wizard.



Alarm Wizard

1. If Continue is selected, the next menu displayed will be in the Alarm configuration wizard.
2. If Save & Exit is selected, the settings and values entered during the Pulse/Frequency configuration wizard will be stored and put into effect.
3. Then the display will show process data. Regardless of selection, the ENTER button must be used to choose either option.
 - Default: Continue

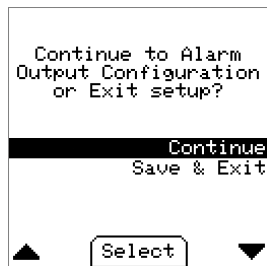

4. Alarm Output Setup Menu:
 - This option determines the type of alarm output.
 - Default: Empty Pipe Alarm.

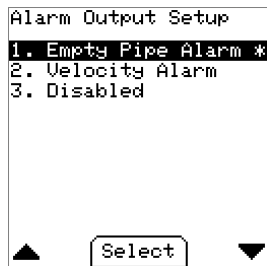

5. Empty Alarm Setup Menu

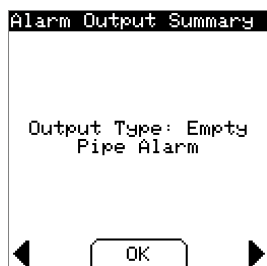

Velocity Alarm - Outputs:

1. Alarm Type Menu:
 - This option determines how the process velocity is compared to the trigger value.
 - Default: Low Limit



2. Alarm Trigger Menu:
 - This value specifies the velocity at which the alarm is active or inactive.
 - Default: 0.1 ft/s

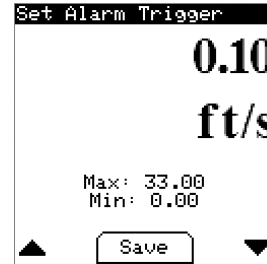

3. Alarm Hysteresis Menu:
 - This value defines a range around the trigger value to prevent excessive switching of the alarm output.
 - Default: 0.1 ft/s

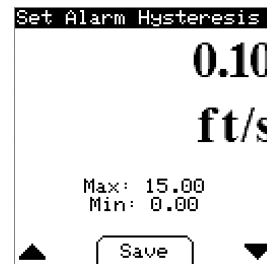

4. Alarm Output Summary Display:
 - This screen shows a summary of the settings entered in the Alarm configuration wizard when velocity alarm is selected.

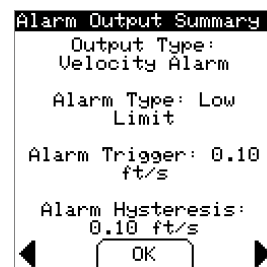

Communication Configuration Wizard

1. If Continue is selected, the next menu displayed will be in the Communication configuration wizard.
2. If Save & Exit is selected, the settings and values entered during the Alarm configuration wizard will be stored and put into effect.
3. Then the display will show process data. Regardless of selection, the ENTER button must be used to choose either option.
 - Default: Continue
4. Select Protocol Menu:
 - This option determines the protocol used by the Transmitter over the RS-485 interface.
 - Default: Disabled.

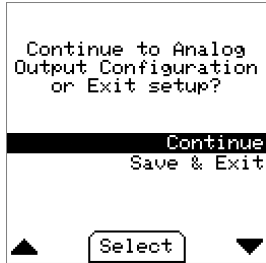

5. Network Address Menu:
 - This value sets the device address on the RS-485 bus. Address range depends on protocol; BACnet Communications Protocol (0-127), Modbus® Communications Protocol (1-247)
 - Default: 127

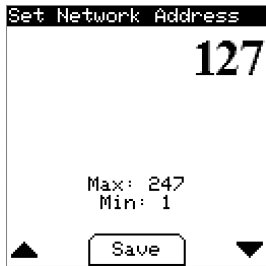

6. Baud Rate Menu:
 - The option selects the communication speed of the RS-485 bus.
 - Default: 19200 (Modbus® Communications Protocol), 38400 (BACnet Communications Protocol)

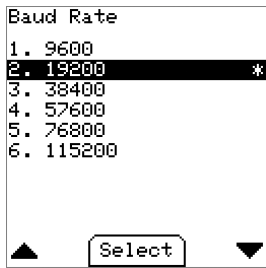

7. Serial Parity Menu (Modbus® Communications Protocol Only):
 - This option sets the serial parity on the RS-485 bus.
 - Default: Even

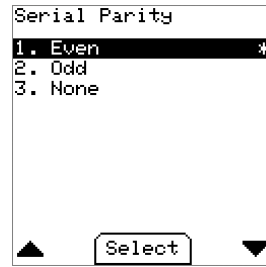

8. Serial Stopbits (Modbus® Communications Protocol Only):
 - The option sets the serial Stopbits on the RS-485 bus.
 - Default: 1



9. Communication Summary Display:
 - This screen shows a summary of the settings entered in the Communication configuration wizard.



- After the Communication Wizard is complete, the Transmitter setup is complete:
- The display will show Setup Complete and transition to display process Data

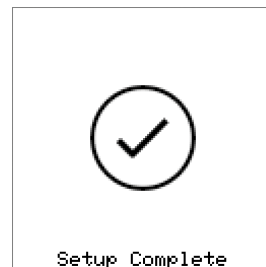

Process Value Display:

- This display is the default view after power on of a configured Transmitter. When the Save & Exit option is chosen from a wizard, this is the next view.
- Use the LEFT and RIGHT buttons to toggle between Flow/Velocity and Total Flow/Process Temperature view.
- Use the MENU or ENTER button to go to the main menu.

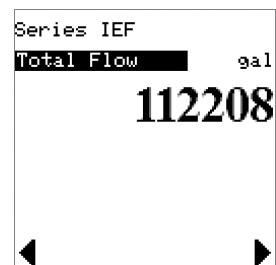
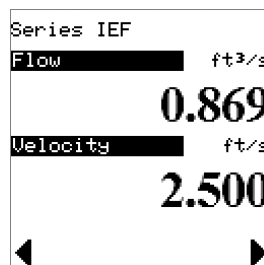

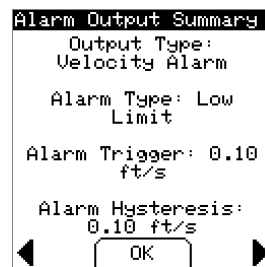
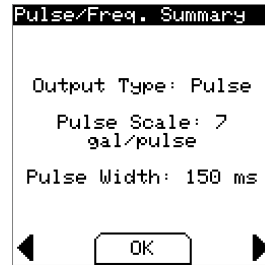
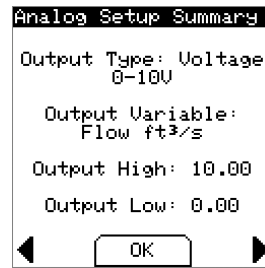
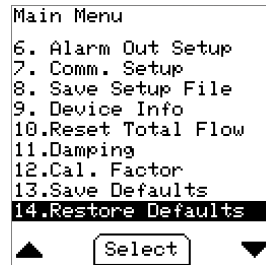

MAIN MENU

1. **Language:** Change the language of the display
2. **Units:** Change the display units
3. **Pipe Setup:** Enter the Pipe setup wizard
4. **Analog Output Setup:** Enter the Analog Output wizard
5. **Pulse/Frequency Output Setup:** Enter the Pulse/Frequency wizard
6. **Alarm Output Setup:** Enter the Alarm Output wizard
7. **Communication Setup:** Enter the Communication wizard
8. **Save Setup File:** Save the current setup to a file.
9. **Device Information:** Show the summary displays from each wizard and other Transmitter/display information.
10. **Clear Flow Total:** Reset totalized flow value.
11. **Averaging:** Configure an averaging time.
12. **Calibration Factor:** Configure custom velocity multiplier.
13. **Save Default:** Save the current settings as the user default values.
14. **Restore Defaults:** Restore the previously saved user settings.



Device Information

- A list of all setting summaries. Use RIGHT  and LEFT  to move between the various summary pages. The last page provided information about the Transmitter and display.

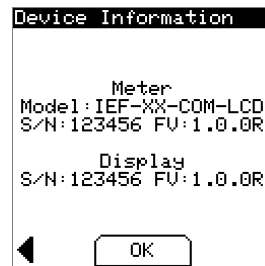
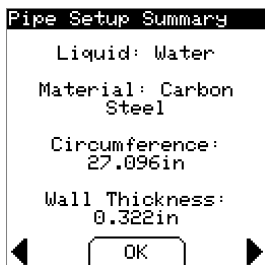
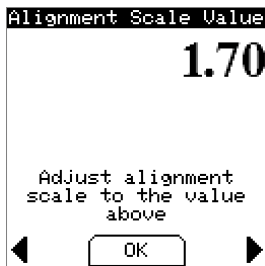
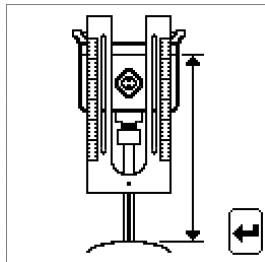

Save Setup File

Create a setup file containing all the options and values selected from the wizards. This file is stored in the display and can be retrieved by connecting a USB cable.



Reset Total Flow

This menu allows the totalized flow value to be reset to

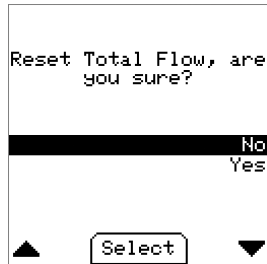

Damping

- This value determines the amount of time the velocity is averaged. The display value will reach 99% of the measured value within this time.
- Default: 30 s



Cal. Factor

- This value sets a custom multiplier of the measured velocity.



Save Defaults

- This menu saves the current configuration as the user default values. This provides a means to save a known good configuration before making other changes.

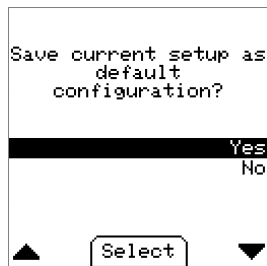

Restore Defaults

- This menu restores the saved user configuration to the current configuration. This provides a means to restore the Transmitter to a known working state.

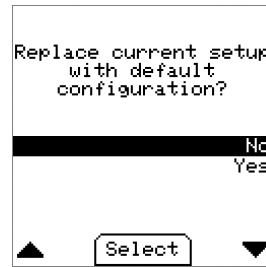

Reset to Factory Default

This special menu is accessed by press & holding ENTER and MENU buttons on the Device Information screen above. Answering Yes, will reset all selections and values to factory default values.

NOTICE All BACnet Communications settings will be reset as well, including the values that can only be set via BACnet Communications.

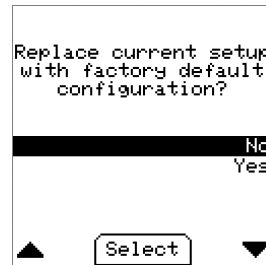

Key Pad Lockout Feature

- For units with the LCD option a switch (shown in Figure 16) is located on the display that allows the keypad to be "locked out" to prevent undesired key presses that could potentially change the transmitter configuration. When the switch is in the "locked" position the display will generate a padlock symbol in the lower right corner as shown below.
- Default: Unlocked.

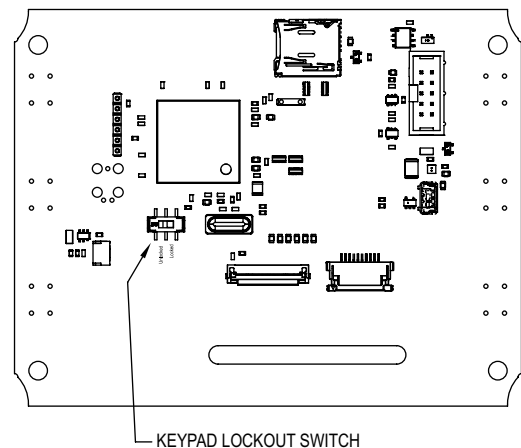
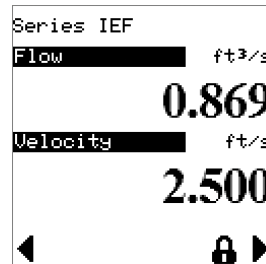

Figure 16

Troubleshooting Guide

A status blink code is conveyed by the blinking of the status LED (Figure 17) using the following parameters.

A blink is defined as the LED is ON for 200ms followed by the LED being OFF for 200ms.

If a status code has a tens digit, the tens digit blink code is created and then followed by a 750ms delay OFF time. Then the ones digit blink code is created. After a blink code is displayed, there is an OFF time of 2 sec before the blink code is displayed again.

If more than one condition is true, the condition with the highest code will be displayed.

Example: Item 3, Invalid Factory Configuration with a blink code of 11.

There would be a state of the LED being ON for 200 msec, then OFF for 200 msec, then ON for 200 msec, then OFF for 200 msec, then ON for 200 msec followed by off for 2 sec before repeating this sequence.

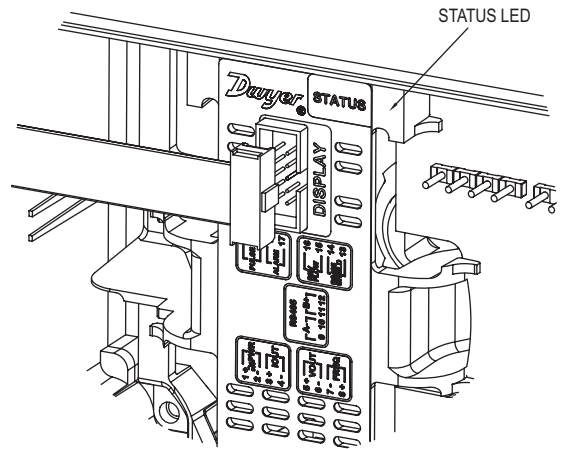
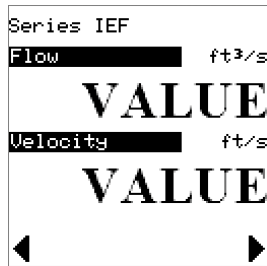
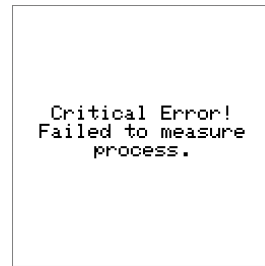

Figure 17

Item	Condition	Status LED Blink Code	Description	Corrective Action
1	Invalid value	1	Invalid calibration (Value display on LCD)	Return to factory, calibration required
2	Empty pipe	2	The probe is not submerged in the process fluid	Ensure the pipe is properly filled, ensure proper installation depth
3	Invalid factory configuration	11	The factory non-volatile configuration is invalid	Return to factory, configuration and calibration required
4	NV access failed	12	The meter failed to read its non-volatile memory	Return to factory for repair
5	NV write failed	13	The meter failed to write its non-volatile memory	Return to factory for repair
6	Wiring board not installed	21	The wiring board was not detected	Return to factory for repair
7	Flyback board not installed	22	The Flyback board was not detected	Return to factory for repair
8	Analog front end board not installed	24	The Analog Front End board was not detected	Return to factory for repair
9	Coil driver board not installed	25	The Coil Driver board was not detected	Return to factory for repair
10	Process temperature fault	26	Temperature sensor not responding	Return to factory for repair
11	Factory variable unlocked	33	The factory variables are unlocked and can be modified	Power cycle, reset, or send lock command to meter
12	Failure to measure process	n/a	Critical Error! Failed to measure process. (On-screen only)	Power cycle, reset via BACnet/Modbus®
13	Communication failure	n/a	Communication with the meter has failed. Settings not saved to meter (On-screen only)	Disconnect and reconnect display
14	Communication failure	n/a	Communication with meter has failed. Attempting to re-establish. Please wait ... (On-screen only)	Disconnect and reconnect display
15	Communication failure	n/a	Critical Error! Failed to access settings in non-volatile storage. (On-screen only)	Power cycle, reset via BACnet/Modbus®, consult factory
16	Settings not saved	n/a	Error: File Not Saved! Access Denied (On-screen only)	Disconnect and reconnect display, replace SD card on display PCBA
17	Settings not saved	n/a	Error: File Not Saved! Storage Media Timeout (On-screen only)	Disconnect and reconnect display, replace SD card on display PCBA
18	Settings not saved	n/a	Error: File Not Saved! Storage Media Not Ready (On-screen only)	Disconnect and reconnect display, replace SD card on display PCBA
19	Settings not saved	n/a	Error: File Not Saved! Storage Media Not Found (On-screen only)	Verify SD card is fully inserted into SD card socket on display PCBA
20	Settings not saved	n/a	Error: File Not Saved! Unknown (On-screen only)	Disconnect and reconnect display, replace SD card on display PCBA



Item 1 Display



Item 12 Display

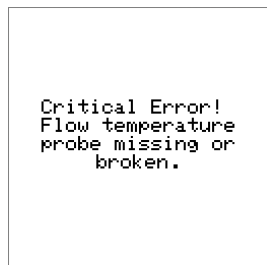

Item 10 Display

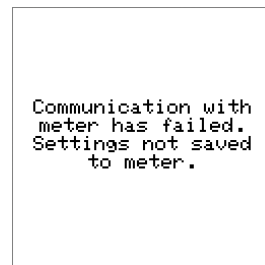

Item 13 Display

Communication with
BTU module has
failed. Attempting
to re-establish.
Please wait...

Item 14 Display

Critical Error!
Failed to access
settings in
non-volatile
storage.

Item 15 Display

Save File Status
Error: File Not
Saved!
Access Denied
OK

Item 16 Display

Save File Status
Error: File Not
Saved!
Storage Media
Timeout
OK

Item 17 Display

Save File Status
Error: File Not
Saved!
Storage Media Not
Ready
OK

Item 18 Display

Save File Status
Error: File Not
Saved!
Storage Media Not
Found
OK

Item 19 Display

Save File Status
Error: File Not
Saved!
Unknown
OK

Item 20 Display

Flow Condition Warnings:

If a reverse flow condition exists an "R" with an exclamation mark in a triangle will appear as shown below:

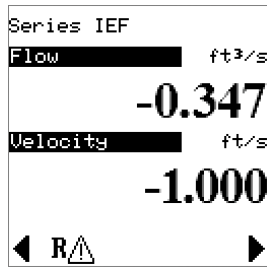

If an empty pipe condition exists an "E" with an exclamation mark in a triangle will appear as shown below:

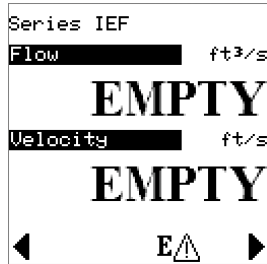

If velocity alarm condition exists a "V" with an exclamation mark in a triangle will appear as shown below:

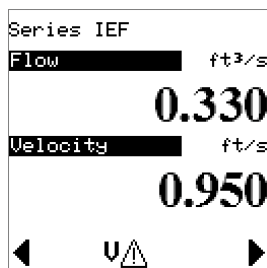

MAINTENANCE/REPAIR

Upon final installation of the Series IEF, no routine maintenance is required, however if recalibration is desired the unit must be returned to Dwyer Instruments, Inc. to be calibrated. Contact customer service to receive a Return Goods Authorization number before shipping your product back for calibration. The Series IEF is not field serviceable and should be returned if repair is needed. Field repair should not be attempted and may void the warranty.

WARRANTY/RETURN

Refer to "Terms and Conditions of Sale" in our catalog or on our website. Contact customer service to receive a Return Goods Authorization number before shipping your product back for repair. Be sure to include a brief description of the problem plus any relevant application notes.

This product uses FreeRTOS (www.FreeRTOS.org) version 9.0.0.
A copy of the original FreeRTOS source shall be provided upon request.



Series IEF Insertion Electromagnetic Flow Transmitter

Specifications - Installation Instructions

For full Installation and Operating Instructions refer to Bulletin F-IEF-F at www.dwyer-inst.com/SeriesIEF



Shown with A-IEF-VLV-BR
accessory valve



-LCD option shown

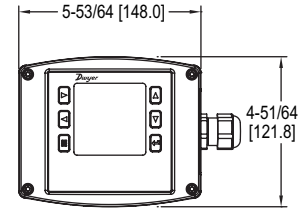
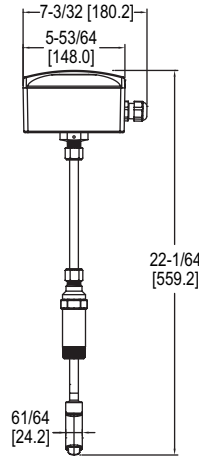

The **SERIES IEF** Insertion Electromagnetic Flow Transmitter is an adjustable insertion flowmeter featuring electromagnetic technology that accurately and reliably measures fluid velocity in addition to providing several continuous signal outputs. This series is specifically designed to offer superior performance paired with simple installation and use. One unit is adjustable to fit pipe sizes from 4 to 36" (101.6 to 914.4 mm), and offers several output options including selectable BACnet MS/TP or Modbus® RTU communications protocol over 2-wire RS-485 in addition to the standard analog, frequency and alarm outputs.

FEATURES/BENEFITS

- Field configurable, integral or remote setup displays (-LCD option or accessory A-IEF-DSP) allow for ultimate flexibility by accommodating a variety of application configurations with one model through multiple display configurations i.e. pipe size, pipe material, liquid type, analog output, pulse/frequency output, alarm outputs, communication outputs, damping, and calibration factor.
- High performance accuracy is maintained through temperature, density or viscosity.
- Setup Wizard and installation tool are simple to use allowing for quick and precise installation.
- Accessory setup kit A-IEF-KIT ensures exact installation application depth with included thickness gage and measuring tape.
- Long Life Cycle and minimal maintenance requirements with no moving parts to wear or break and electrodes that discourage fouling.
- Isolation valve accessory options allow for installation in operational systems via hot-tap kit or easy removal without system downtime.
- NIST calibration certificate included standard for Carbon Steel Schedule 40 pipes sized 4" (100 mm), 6" (150 mm), 8" (200 mm), and 10" (250 mm) with high accuracy option.

APPLICATIONS

- Boiler feed water
- Chilled water
- Open and closed loop condenser water
- Irrigation system
- Municipal water distribution
- Process and coolant flow
- Ground water remediation
- Chemical processing
- Pump protection
- Wastewater
- Mining

SPECIFICATIONS

Service: Compatible clean or dirty non coating, conductive liquids.

Range: 0 to 20 ft/s (0 to 6 m/s).

Wetted Materials: Body shaft/fitting: 316SS; Electrodes: 316SS; Electrode cap: Polymer/Polystyrene; O-ring: Silicone.

Accuracy: IEF-HX-X: $\pm 0.5\%$ of reading at calibrated velocity; $\pm 1\%$ of reading from 2 to 20 ft/s (0.6 to 6 m/s) ± 0.02 ft/s (± 0.006 m/s) at < 2 ft/s (0.6 m/s). IEF-SX-X: $\pm 1\%$ FS.

Temperature Limits: Ambient: -20 to 160°F (-29 to 71°C); Process: 15 to 250°F (-9 to 121°C); Storage: -40 to 185°F (-40 to 85°C).

Process Connection: 1" NPT or BSPT with accessory full port ball valve options.

Pressure Limits: 400 psi (27.6 bar) @ 100°F (37.8°C).

Pressure Drop: < 0.1 psi at 12 ft/s in 4" (101.6 mm) and larger pipe.

Outputs:

- (1) Analog: 4 to 20 mA, 0 to 5 V, 0 to 10 V or 2 to 10 V (display selectable);
- (1) Pulse/Frequency: 0 to 15 V peak pulse, 0 to 500 Hz or scalable pulse output (display selectable);
- (2) Alarms: (1) Empty pipe detection or minimum/maximum velocity, (display selectable); (1) Reverse flow output indication.

Power Requirements: 12 to 42.4 VDC, .25 A @ 24 VDC; 12 to 36 VAC.

Electrical Connection: Removable terminal blocks, model selectable 1/2" female NPT conduit connection, PG 16 gland or PG 16 gland with (2) 10 ft (3 m) 9 conductor 22 AWG plenum rated cables, accessory cable lengths up to 200 ft (61 m) optional.

Display (-LCD option): 2" (5.08 cm) x 2" (5.08 cm) graphic LCD with backlight.

Conductivity: > 20 microsiemens.

Enclosure Material: Powder coated die cast aluminum.

Enclosure Ratings: NEMA 6P (IP68) (Non display models); NEMA 4X (IP66) (-LCD option).

Agency Approvals: BTL, CE, NSF/ANSI 61 and 372 pending.

COMMUNICATIONS (-COM OPTION)

Type: BACnet MS/TP or Modbus® RTU communication protocol (default disabled, display selectable).

Supported Baud Rates: 9600, 19200, 38400, 57600, 76800, or 115200 bps (display selectable).

Device Load: 1/8 unit load.

ADDITIONAL SPECIFICATIONS

Applicable Pipe Material: Most popular plastic and metal pipes; i.e. Carbon steel, SS, copper, UPVC/PVDF, galvanized steel, mild steel, and brass.

Applicable Pipe Size: IEF-HX-X: 4 to 10" (101 to 254 mm); IEF-SX-X: 4 to 36" (101 to 914 mm).

Diameter Length Requirements: > 10 upstream, > 5 downstream.

Modbus® is a registered trademark of Schneider Automation, Inc.

MODEL CHART						
Example	IEF	-H	N	-CND	-LCD	IEF-HN-CND-LCD
Series	IEF					Insertion electromagnetic flow transmitter
Accuracy		H S				High accuracy; 1% of reading Standard accuracy; 1% FS
Process Connection			N B			1" NPT 1" BSPT
Electrical Housing Connector				CND PG 10		1/2" female NPT PG 16 gland PG 16 gland with (2) 10' (3 m) plenum rated cables
Options					LCD COM NIST FC CC	Integral LCD BACnet or Modbus® communication protocol (display selectable) Multiple point NIST traceable calibration certificate Factory calibration certificate for 0.5% of reading at single point Custom configured for specific installation

ACCESSORIES	
Model	Description
A-IEF-KIT	Setup kit (includes setup display, thickness gage and measuring tape)
A-IEF-DSP	Setup display
A-IEF-CBL-50	Plenum rated cable 50 ft (15.2 m)
A-IEF-VLV-BR	1-1/4" full port isolation valve brass
A-IEF-VLV-SS	1-1/4" full port isolation valve 316SS
A-IEF-INGD	Installation alignment kit
A-IEF-PA	AC wall adapter

INCLUDED WITH THE FLOWMETER

Carefully unpack the shipping container of your new Series IEF Insertion Electromagnetic Flow Transmitter and remove the following items:

- (1) Series IEF Insertion Electromagnetic Flow Transmitter
- (1) A-IEF-INGD Installation Alignment Kit:
 - (1) Alignment Scale
 - (2) Alignment Rods
 - (2) Thumbscrews
- (1) 3 mm Allen Wrench (not shown)

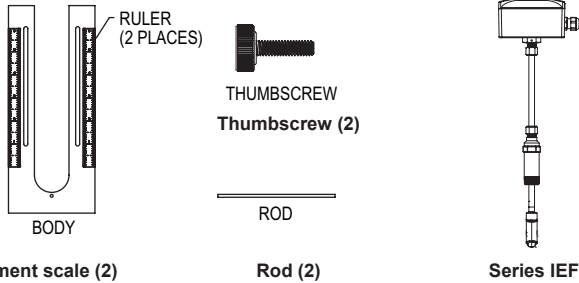

Figure 1

RECOMMENDED TOOLS

- (2) 12" (300 mm) adjustable wrenches
- (1) 12" (300 mm) pipe wrench

SETUP

Selecting Installation Location

1. Although the unit may be installed in any orientation, the ideal mounting position is on the side of the pipe (2 o'clock or 10 o'clock position) as this generally minimizes possible air or sediment interference with the Series IEF.

Note: When installing a unit with an integral display select an installation location that allows for clear viewing of the display and proper earth ground.

Insert the IEF in a pipe via a threaded Tee, Saddle, or welded integrally reinforced branch connection outlet fitting.

If a Hot-Tap option is required, use a 1-1/4" valve kit with proper mounting hardware available in Model A-IEF-VLV-BR or A-IEF-VLV-SS. A 1" (25.4 mm) hole in the pipe is required for proper installation.

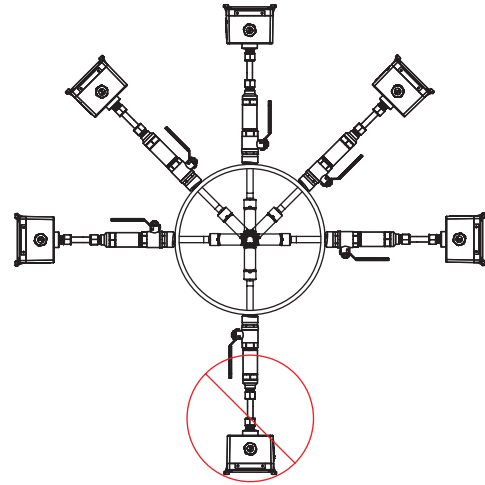

Figure 2

2. Select a location that will minimize flow distortion with adequate upstream and downstream pipe diameters as displayed. Ideal installation will have a minimum of 10 pipe diameters upstream relative to the instrument and a minimum distance of 5 pipe diameters downstream.

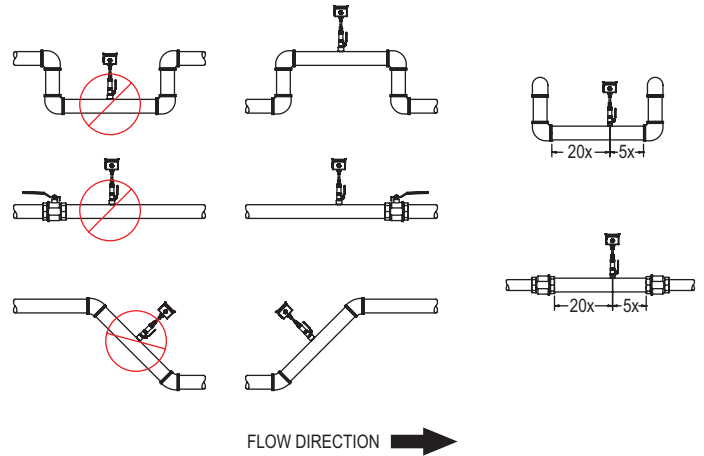

Figure 3

INSTALLATION

1. To prepare the meter for installation, mount the provided alignment scale to the side of the meter with the two provided thumbscrews. The thumbscrews are to be inserted through the alignment scale slots and into the holes in the side of the lid as shown in Figure 4, finger tighten only. Be sure to orient the alignment scale as shown in figure below. Actual scale setting determined in next step.

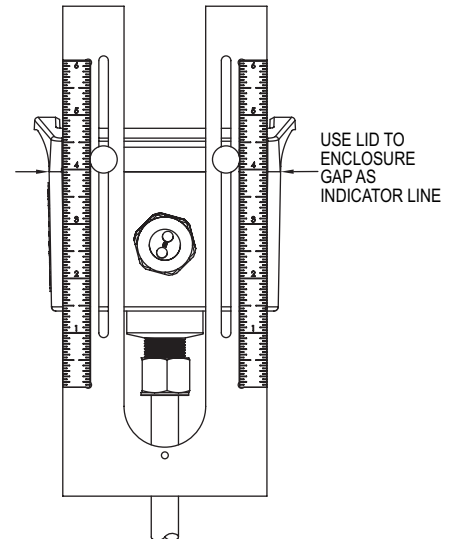

Figure 4

For Custom Configured Models (-CC Option)

2. Locate the configuration tag attached to the Series IEF to identify the value of the alignment scale setting. Position the alignment scale such that the scale setting is lined-up with the seam of the enclosure as shown in Figure 4. Minor scale marks are in 1/20ths. Securely tighten the thumbscrews.
3. Refer to Preparing the Unit for Installation section.

For Field Configurable Models

2. For field configuration a display is required (-LCD option or accessory A-IEF-DSP) and needs to be powered via normal field wiring or with the AC wall adapter accessory A-IEF-PA (A-IEF-DSP and A-IEF-PA are also available in the accessory setup kit A-IEF-KIT).
3. When using the AC wall adapter and the cable is supplied, connect the red (positive +) and black (common -) wires of the cable bundle marked "A" to the open terminals of the AC wall adapter. This will provide temporary power to the meter to complete the installation set up.
4. For field wiring refer to the wiring chart tag attached to the Series IEF to identify the terminal block pins for positive (+) and common (-) connection.
5. Unscrew the four captured cover screws using the supplied 3 mm Allen wrench to remove and set aside enclosure cover.
6. Insert one connector of the ribbon cable supplied in the setup kit into the connector labeled "Display" in the middle of the unit. Be sure to orient the keying feature/tab. See Figure 5 below:

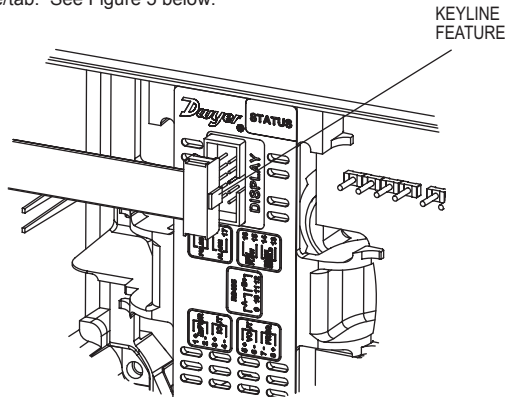

Figure 5

7. Plug the other end of the cable into the bottom of the supplied portable display being sure to orient the keying feature/tab as shown:

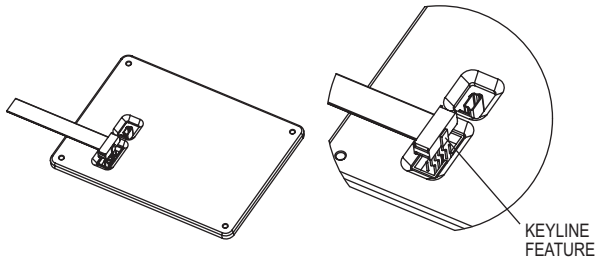

Figure 6

8. Apply power to the unit and the display will turn-on automatically. Follow the on screen directions for entering the necessary parameters to setup the unit and obtain the alignment scale setting value.

NOTICE Precise pipe measurements are required for high performance installation. The A-IEF-KIT includes setup display A-IEF-DSP, thickness gage UTG and measuring tape A-IEF-MSTP used to obtain these measurements. When the precise pipe measurement information is known select Option 2 High Performance setup in the Install Kit option of the display selection

NOTICE When using measuring tape A-IEF-MSTP to measure pipe circumference use the 100ths side to measure the circumference of the pipe without insulation.

Preparing the Unit for installation (Refer to Figure 7)

1. Apply appropriate sealant to the process collet (5) threads such as application suitable sealant tape or paste.
2. Install the process collet (5) in valve (6) then tighten by hand.
3. Tighten the process collet (5) with a wrench using the hex geometry until snug.

NOTICE Use two wrenches, one to hold the valve and another wrench to turn the process collet.

4. Slowly open the valve handle (7) checking for leaks.
5. If leaks occur around threaded connections, close the valve and tighten those connections.

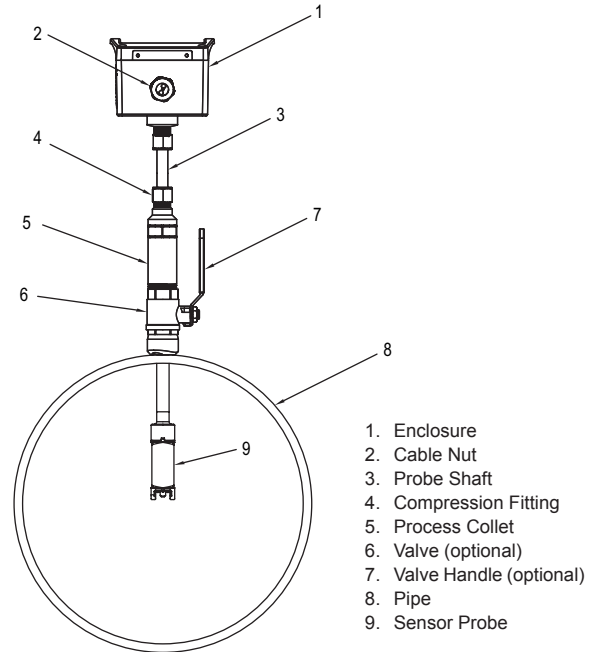

Figure 7

NOTICE Do not adjust housing compression nut at top of probe shaft (3).

Sensor Alignment

A depth and flow alignment installation tool is provided to ensure proper depth insertion and flow alignment. To set the insertion depth verify the alignment scale has not moved from its original setting based on the alignment scale value set previously.

Loosen compression nut (4) to allow the shaft (3) freedom to travel up and down and rotate inside the process collet (5).

Install Depth and Alignment Rods

1. Remove alignment rods from sides of alignment scale by sliding them out.
2. Insert the two rods into the alignment scale as shown.

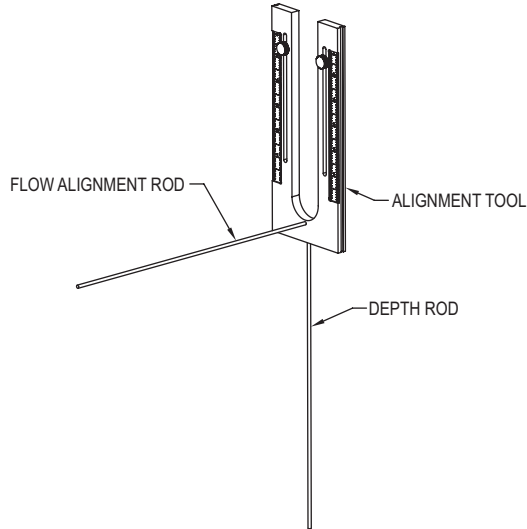

Figure 8

3. Rotate the transmitter so the pipe alignment rod is parallel with the flow in the pipe.

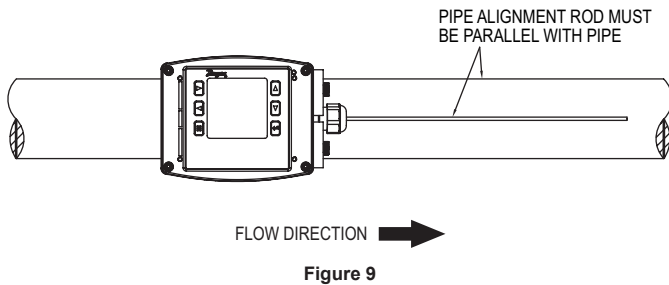

Figure 9

4. Slide the shaft (3) down into the process collet (5) until the depth rod contacts the pipe. If pipe insulation is present press the rod through the insulation.
 - a. Tighten the nut (4) to 15 ft.-lbs (20.3 N m)
 - b. Remove the flow alignment rod and loosen the thumbscrews to slide the alignment tool up to allow removal of the depth alignment rod. Store both rods in the storage slots on the sides of the alignment scale. Tighten thumbscrews and leave alignment tool mounted on unit for storage.

GROUNDING

Metallic Pipe

For proper operation the instrument must be earth grounded.

Connect a ground wire to meter housing via the ground lug on the housing collet. Connect the ground wire to a known earth ground.

If the pipe is grounded, connect the ground wire to the metal pipe using suitable devices such as grounding clamps.

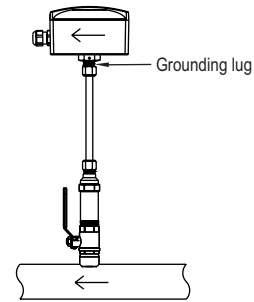

Figure 10

Non-Metallic Pipes

Connect a ground wire to the transmitter housing per the ground lug on the housing collet.

Connect the ground wire to a known earth ground.

Ground the fluid to earth.

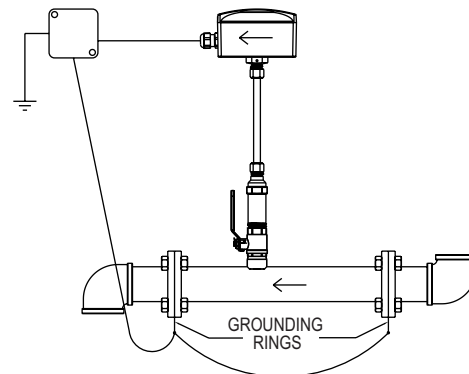

Figure 11

POWER SUPPLY

Choose a power supply with a voltage and current rating sufficient to meet the power specifications under all operating conditions.

If the power supply is unregulated, make sure the output voltage remains within the required voltage range under all power line conditions.