

Twist-Lock® Devices Switched Safety Enclosures Switched Enclosure

HUBBELL

Features

- Lockable handle provides lockout protection for greater safety and complies with OSHA lockout requirements
- Horsepower rated switch
- Large receptacle gasketless door and hinge assembly
- Heavy-duty internal frame bonds conduit and all grounds and has a DIN rail to accommodate the switch

Ordering Information

Description	Device Color	UPC	Catalog Number
Switched Twist-Lock enclosure with a pre-wired HBL2730 receptacle	Gray	783585006352	SE2730A

Listings

Listed to UL Standard
CSA Certified Type 3R and 12K Enclosure Rating

Specifications

Base	PBT
Top	PBT
Handle	PBT
Conduit Hub	Zinc 3/4" watertight
Enclosure Gasket	Neoprene
Shaft	PBT

Performance

Electrical	
Current Interrupting	Certified for current interrupting at full rated current and voltage
Dielectric Voltage	Withstands 3,000V minimum
Max. Working Voltage	600V RMS
Operations	Mechanical 10,000 cycles; Electrical 6,000 cycles
Mechanical	
Impact Resistance	In accordance with UL 746C
Mounting	External fully adjustable feet
Product Identification	Identification and ratings are part of external label and receptacle face
Terminal Identification	In accordance with UL, CSA and international conventions
Environmental	
Flammability	UL94 – 5 VA and V0 classification
Moisture Resistance	IP54 suitability
Operating Temperature	Maximum continuous +75°C; Minimum continuous -40°C
UV Resistance	All materials are UV stabilized

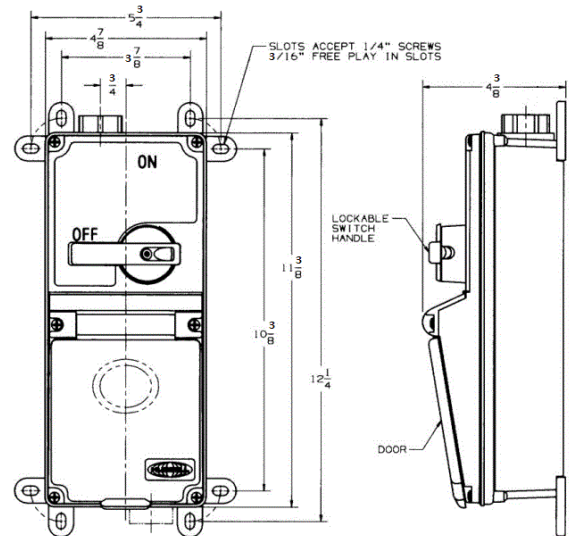

Accessories

Plug	HBL2731
------	---------

Resources

Customer Use Drawing
eCatalog

Dimensions in Inches (mm)

Hubbell Wiring Device-Kellems • Hubbell Incorporated (Delaware) • 40 Waterview Drive • Shelton, CT 06484

Phone (800) 288-6000 • Fax (800) 255-1031 • Specifications subject to change without notice.

