

Datasheet

RS Stock No. 1253592

RS Pro High Pressure, Self-priming Micro-pump with EQi Controller

Overview : High Pressure Pump Range, Self Priming, Brushless Drive

The MG2000 series range of pumps deliver consistent flow with high or low pressure. It is suitable for low or high viscosity liquids and is self-priming. The body is constructed from precision CNC machined aluminium alloy and wetted parts are stainless steel, PEEK, polyacetal and PTFE. The MG2000 range can be used with all common liquids and also resists most chemicals and solvents. The pump has two tubing connector options ; stainless steel threaded tubing connectors for quick and easy to connection to tubing, or for directly mounting to your manifold. Flow is reversible.

Pump Variants



Note.

The MG2000 pump range utilizes high performance, efficient sensorless brushless motor technology.

These motors require a separate controller to operate and TCS Micropumps offer the EQ range of controllers for this purpose.

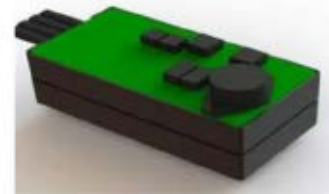

Typical Applications

- Medical devices
- Fuel Cells
- High Pressure Fuel Pump
- Cooling Systems
- Precision Flow
- Lubrication systems

Features

- High pressure capability
- Self-priming
- High and low viscosity liquids
- Smooth almost pulseless flow
- Reversible flow
- CNC aluminium alloy construction
- Small size only 90 x 53 x 50 mm
- Weight 340g

Datasheet
RS Stock No. 1253592

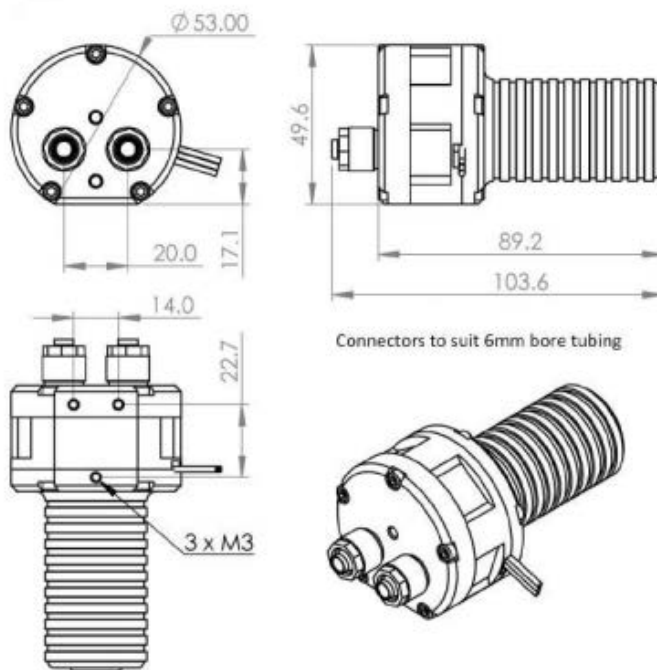

Materials

Wetted Parts

- Anodised 6000 Series Aluminium
- 316 Stainless Steel
- Viton
- PEEK
- PTFE
- Polyacetal
- Materials typical to a Brushless Motor

Performance Data

- Small Size 90 x 53 x 50mm
- Weight 340 g
- Operating Temp -20 to 100 deg C
- Smooth Pulseless Flow
- IP Rating - Standard pumps IP67
- Noise Levels 15dB
Measured at a distance of 1m with a 50dB ambient noise level
- Viscosity up to 150,000 cSt
- MTBF Stock Pumps 10,000hrs
Special Variants available to order >100,000hrs

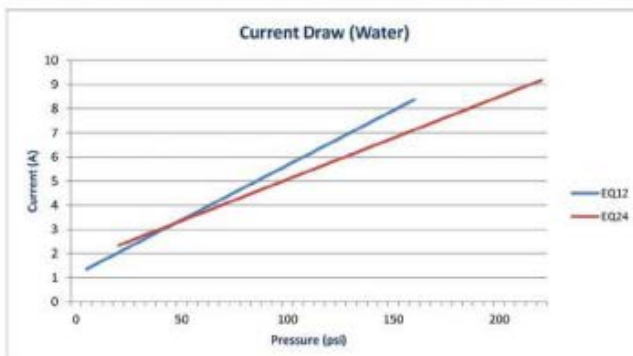
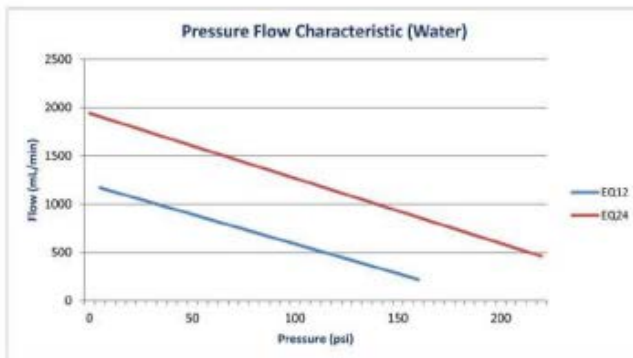

Controller	Input (V)	Power (W)	Flow (ml/min)	Pressure (psi)
EQ12	12	15-99W	1170	160
EQ24	24	40-216W	1940	220

Performance for stock pumps running on TCS Coolant

Pressure shown is the not to exceed value. All MG2000 pump variants are capable of more than the indicated figure but exceeding this may result in damage to the pump.