

Datasheet

RS Stock No. 1253579

RS Pro Long Life Brushless Micro-pump

Overview : Extra Long Life Brushless Micro Pump for Liquids

The M410 range of pumps are driven by a brushless drive motor with built in electronic controller. Constructed from precision CNC machined aluminium alloy with stainless steel tubing connectors and fitted with Viton seals as standard. Alternative seal materials and optional wetted part coatings and materials are also available enabling this pump range to resist most chemicals and solvents. The pump uses efficient push fit connectors designed for 6.0mm (S variants) or 3.2mm (K variants) flexible tubing. Fitted with a JST power connector and supplied with a 200mm electrical fly-lead as standard.

Pump Variants



M410S - Standard pump suitable for most applications



M410K - Standard pump for small bore tubing



M410-180 - Standard pump for inline flow connection
Available in both S and K variants



M410-M - Manifold mount variant for an installation without the need for tubing and connectors

Typical Applications

- Medical devices
- Fuel Cells
- Battery and Solar Powered Systems
- Cooling Systems
- Low Pressure Fuel Pump
- Lubrication systems

Features

- Brushless drive motor + integral controller
- CNC aluminium alloy construction
- Quiet pulseless smooth flow
- Small size only 46 x 26 x 25 mm
- Weight 41g
- Free flow up to 2600ml per minute (water)
- Usable with solar power, PSU or batteries
- Wide range of chemical resistance

Datasheet
RS Stock No. 1253579

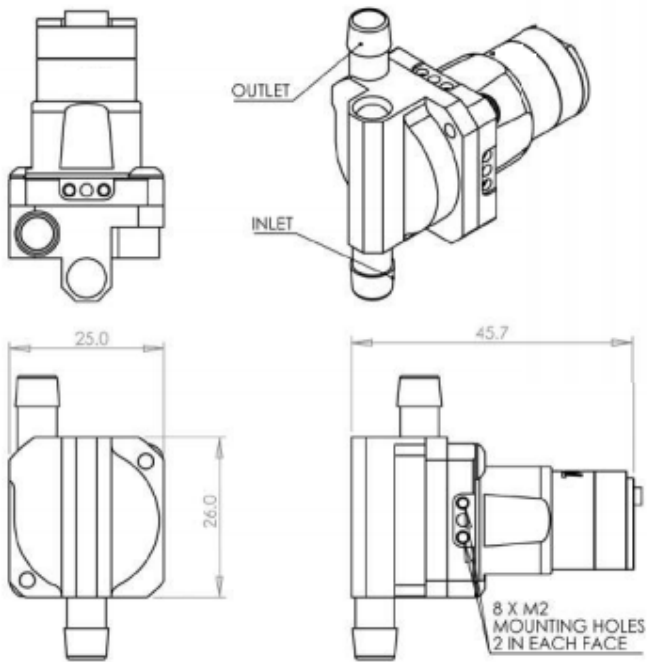

180 version shown. Connectors to suit 6.0mm tube (S variants) and 3.2mm tube (K variants)

Performance - 12v

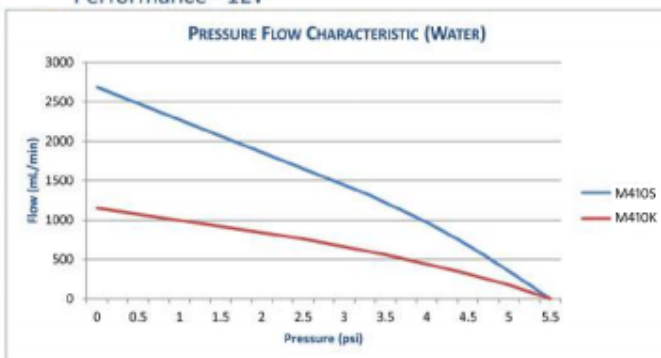

Performance - 6v

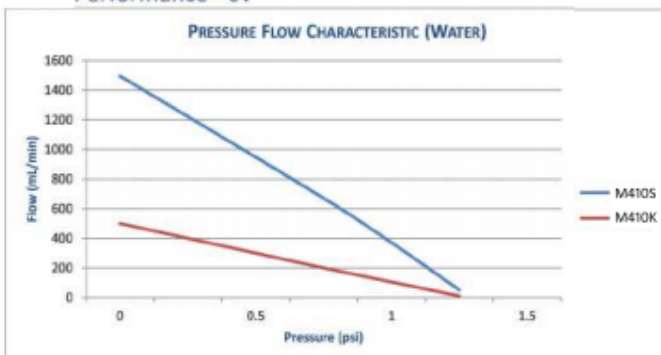

Materials

Wetted Parts

- Anodised 6000 Series Aluminium
- 316 Stainless Steel
- Viton
- Polyacetal

Other

- Materials typical to a Brushless Motor

Performance Data

- Small Size 25 x 26 x 46mm
- Weight 41 g
- Operating Temp -20 to 100 deg C
- Smooth Pulseless Flow
- IP Rating - Standard pumps IP45
- Noise Levels <3dB
Measured at a distance of 1m with a 50dB ambient noise level
- MTBF Stock Pumps 10,000+hrs

Variant	Input (V)	Power (W)	Flow (ml/min)	Pressure (mBar)
M410S	6	1.3	1495	86
	12	7.1	2685	380
M410K	6	1.2	500	86
	12	5.8	1150	380