

Net Chaser™

USER MANUAL



PLATINUM TOOLS®

www.platinumtools.com

Table of Contents

Introduction.....	4
Kit Contents.....	5
Optional Accessories.....	6
Safety Information.....	7
Net Chaser Description.....	8
Active Remote Description.....	9
Net Chaser Touch Screen and Buttons.....	10
General Operations.....	11
System Settings.....	12
First System Settings Screen (IP Setup).....	12
Second System Settings Screen (Language).....	13
Third System Settings Screen (Display Settings).....	13
Fourth System Settings Screen (Time and Date).....	14
Fifth System Settings Screen (Timeout Settings).....	15
Sixth System Settings Screen (User Information).....	16
Seventh System Settings Screen (Firmware).....	17
Eighth System Settings Screen (Firmware/Hardware versions).....	21
Active Remote.....	22
Cable Test.....	23
Cable Test Overview.....	24
Cable Test Setup.....	25
Cable Type.....	26
New Cable Type.....	26
Edit Existing Cable Type.....	27
Select Cable Type.....	27
Cable Name.....	27
Ethernet Cable Test.....	27
Cable Faults.....	28
Saving Cable Tests as PDF.....	29
Saving a PDF Report.....	30
Saving Test List as CSV.....	30
Create a New Test List.....	31
File Manager.....	31
Link Test.....	32

Port Discovery.....	32
POE Test.....	32
Tone.....	32
Link Light.....	33
BERT Only Test.....	33
Network Test.....	34
Link Test.....	34
DHCP.....	34
Ping Test.....	35
Trace Route.....	35
VLAN.....	36
Discovery Protocols.....	37
File Manager.....	38
USB Mode.....	38
Icon Glossary.....	39
Frequently Asked Questions.....	40
Maintenance.....	43
Customer Service.....	43
Specifications.....	44
Warranty Information.....	45

Introduction

The Net Chaser Ethernet Speed Certifier & Network Tester offers a complete solution to test copper cables. The Net Chaser performs speed certification to test the data-carrying capabilities of electrical Ethernet network cable up to 1 Gb/s by testing for noise in the network, detecting faults in the cable wiring, and ensuring that cables are able to support the speed capabilities of active equipment.

To certify Ethernet speed performance of copper cable runs, the Net Chaser handheld tester conducts Bit Error Rate (BER) tests by sending data packets down specified cable runs at defined data rates to check for errors at the maximum throughput of the link. The Net Chaser also reports on signal quality that can impact high-speed data transmission by measuring signal to noise ratio (SNR). Skew measurements report on the signal time delay between pairs that can impact Ethernet data transmission. The Net Chaser also provides continuity testing that detects opens, shorts, miswires, split pairs, reversals, and high-resistance faults while accurately measuring distance to faults and total cable length.

The Net Chaser includes a comprehensive set of features for testing active network capabilities: measure Power over Ethernet (PoE) to ensure the correct power is available on the correct pins, use Port Discovery to ensure the correct speed and duplex capability are available; connect at gigabit Ethernet and run ping tests to verify connectivity to IP hosts; discover network devices using Cisco Discovery Protocol (CDP) or Link Layer Discovery Protocol (LLDP); VLAN discovery; Trace Route function displays the path internet packets travel to reach a specified destination. The Net Chaser also saves test reports and exports to PCs.

Net Chaser

The Net Chaser comes in one kit that will cover all your needs.

Part Number	Description
TNC950AR	Net Chaser Main Unit
	Active Remote
	Power Supply (2)
	Network Patch Cables (2)
	RJ45 Port Saver Cables (2)
	4GB SD Card
	Micro USB Cable
	Hanging Strap with Carabiner Clips
	Large Carrying Case
	User Manual

NOTE



To optimize the life of the rechargeable Lithium-ion battery, please fully charge and fully exhaust the battery in the tester three times before charging the battery at mid-levels.

Optional Accessories

P/N	Description
T138	#1-8 Network Testing and ID Remotes
TRK120	#1-20 ID Only Coax Remotes (Not for RF testing)
TRK220	#1-20 ID Only Network Remotes (for Mapping only)
TAK030	Network Accessory Kit includes: (4x) 1ft. Network Patch Cables, (2x) RJ45 to 8-way Alligator Clips, (2x) F-Jack to BNC Adapter, (2x) RJ45 Port Savers
TAR104	Net Chaser Active Remote with selectable ID's #1-4
TP150	Tone & Probe Kit
TAK010	Hanging strap with carabiner clip
TPS120	AC to DC Power Supply: 12V 2.5A Includes international adapter plugs NA/EU/AU/UK
21025C	RJ45 Port Saver for extending life of modular plug
TCA015	24 inch cable assembly 8-way alligator clips to RJ45
TCA016	1 ft. Network patch cables
4007	Hanging pouch
18301	F-Connector Coupler (F81)

Safety Information

To ensure safe operations of the Net Chaser, follow instructions carefully and observe warning and caution messages in this manual. Failure to observe warnings can result in severe injury or death and can damage the equipment.

Notification	Definition
	Warning/caution: potential for personal injury or damage to equipment
Voltage!	Warning: hazards could cause harm or death
	Conformité Européenne. Conforms to European Economic Area directives
	Disposal Information



Warning!

To avoid possible fire, electric shock, or personal injury:

- Do not open the case: no user-serviceable parts are inside.
- Do not modify the tester.
- Do not use the tester if damaged. Inspect the tester before use.
- The tester is not intended to be connected to active telephone inputs, systems, or equipment, including ISDN devices. Prolonged exposure to the voltages applied by these interfaces may damage the tester.
- The Lithium Ion battery pack should be serviced by qualified personnel. Only the original battery pack type should be used with this product.

Net Chaser Description

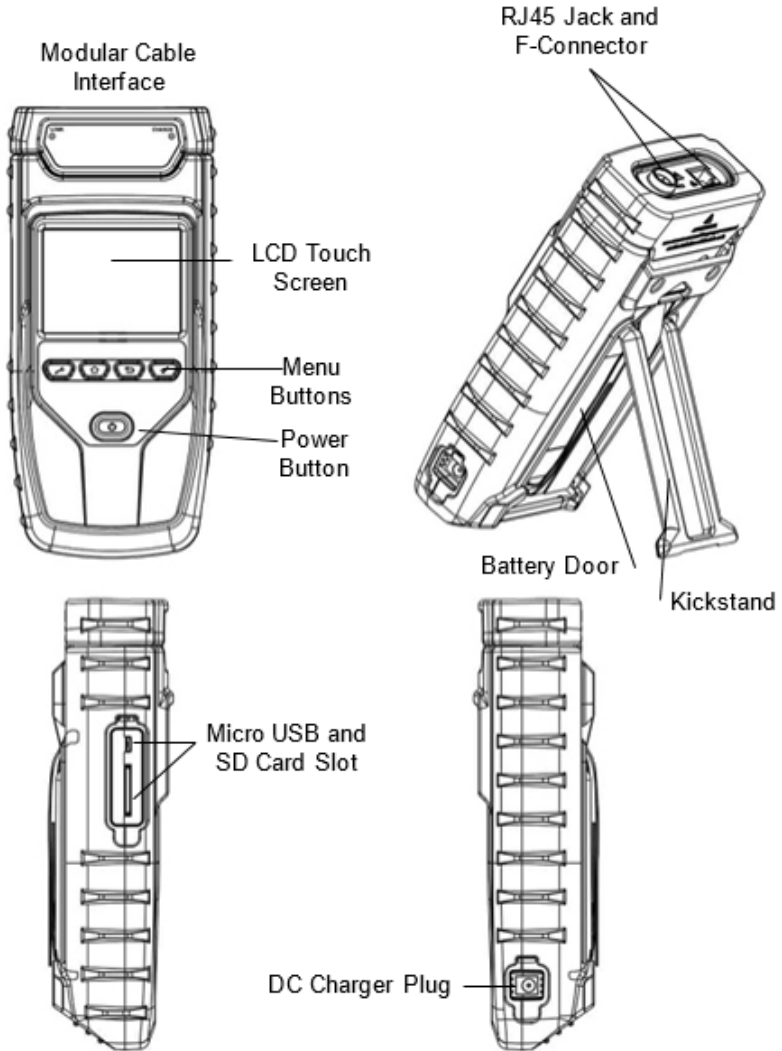

Active Remote

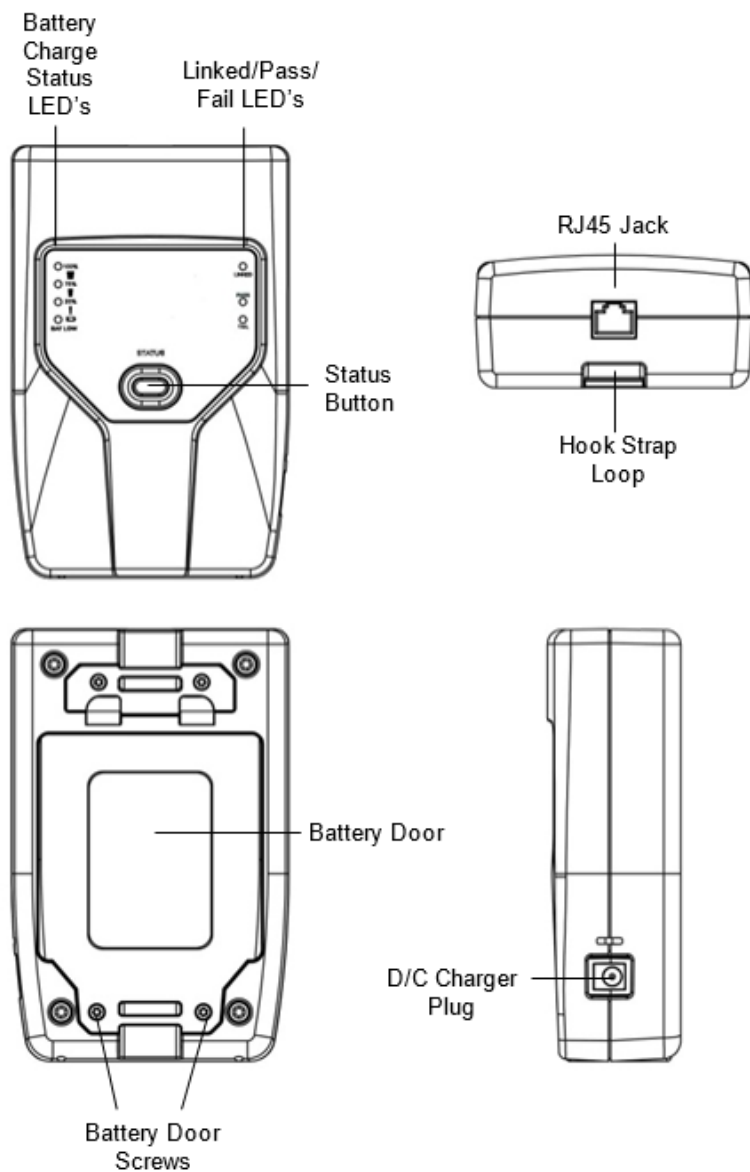

Net Chaser Buttons and Touch Screen

The Net Chaser features buttons and a full color capacitive touch screen to allow for easy navigation

Touch an icon to select an option

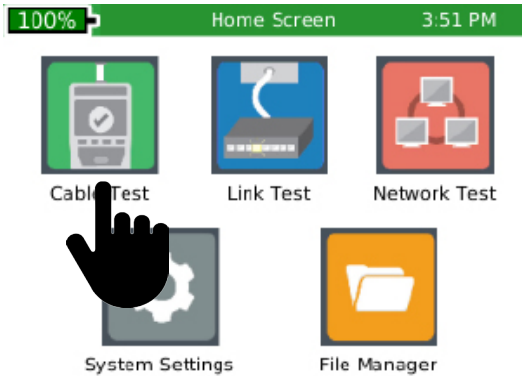

Touch and drag a list to scroll up or down or touch the Up/Down arrows

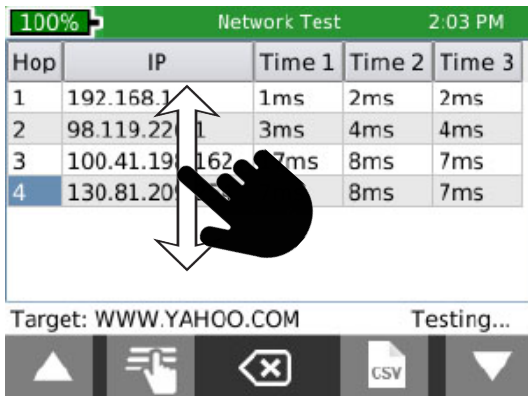

The Net Chaser buttons assist with Navigation, starting and stopping a test



- Settings** - The Settings button will display the settings menu. Pressing the settings while in the settings menu will display additional menu screens.
- Home** - The Home button will display the home screen from any menu.
- Back** - The Back button will display the previous screen.
- Test** - The Test button will start/stop a test.

General Operations

On/Off

- Turn Net Chaser on by pressing the Power button 
- Tap the Power button to put the Net Chaser in sleep mode.
- Press and hold the Power button to power the unit off.

Automatic Power Down

The Net Chaser automatically enters sleep mode to conserve battery power if no input or activity is performed on the device. See System Settings on page 15 to adjust the length of time before the automatic power down occurs.

Net Chaser Active Remote

Check the Active Remote battery status and last test result by pressing the Status button.



System Settings

The Net Chaser Setup consists of eight screens to configure the unit to the user's preference. Use the Settings button  to navigate through the settings screens.

First System Settings Screen: IPV4 Setup

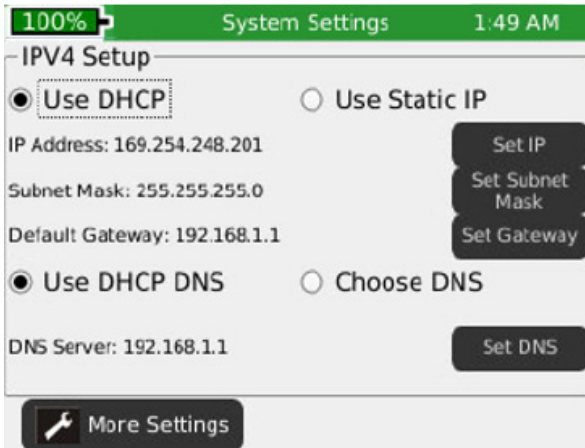
In the IPV4 setup screen, the Net Chaser's network tests can be configured to use DHCP or a Static IP addresses. The Net Chaser can also be set to use a DHCP provided DNS or a fixed DNS IP



- Turn the Net Chaser on by pressing the Power button .
- Touch System Settings  on the home screen.
- “Use DHCP” is set as default. To enter static IP's touch “Use Static IP” and enter the following:
- Touch “Set IP” and enter the Net Chaser IP address using the numeric keypad, then touch **OK**.
- Touch “Set Subnet Mask” and enter the Subnet Mask IP address using the numeric keypad, then touch **OK**.
- Touch “Set Gateway” and enter the Gateway IP address, then touch **OK**.
- Use “DHCP DNS” is set as default. To manually enter DNS addresses, touch “Choose DNS”.
- Touch “Set DNS” and use the numeric keypad to enter a preferred DNS IP address and touch **OK**.

Second Systems Settings Screen: Language/Date Format

Language

- Select the desired Language.

Date Format

- Select the desired date format:
- Month/day/year or day/month/year



Third Systems Settings Screen: Display Settings

Length settings:

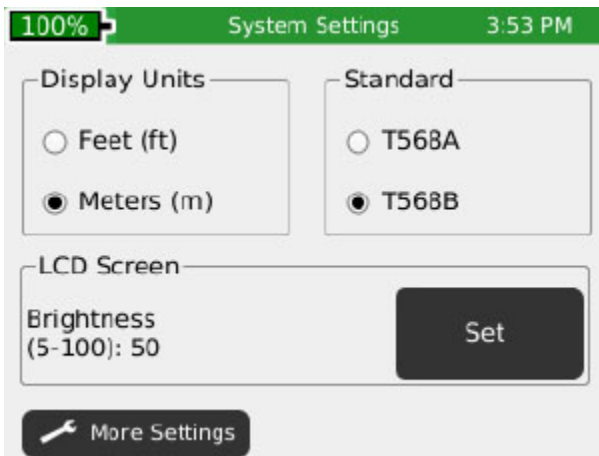
- Under Display Units, touch either Feet or Meters.
- Under “Standard”, touch either T568A or T568B. The touched wiring standard will be displayed in the cable test wiring diagram.







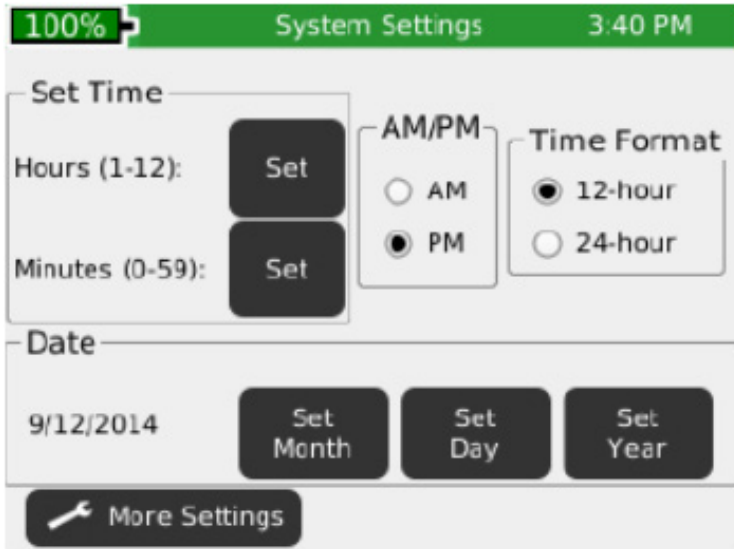

LCD Screen Brightness:

- To the right of Brightness, touch Set.
- Enter a number between 5 and 100 then touch OK. To cancel, press the Back button .
- To continue, touch More Settings or press the Settings button .

Fourth Systems Settings Screen: Display Units





Set time/clock/date:

- Under Time Format, touch either 12-hour or 24-hour format.
- To the right of Hours (1–12), touch Set Hour. Enter the hour you wish to display then touch **OK**.
- To cancel, press the Back button .
- To the right of Minutes (0-59), touch Set Minute. Enter the minutes you wish to display then touch **OK**. To cancel, press the Back button .
- Under AM/PM, touch AM or PM on the screen.
- Under Date, set the month, day, and year: Touch Set Month. Enter the number of the month, and then touch **OK**. To cancel, press the Back button .
- Touch Set Day. Enter the number of the day, and then touch **OK**. To cancel, press the Back button .
- Touch Set Year. Enter the year (all four digits), then touch **OK**. To cancel, press the Back button .
- To continue, touch More Settings or press the Settings button .

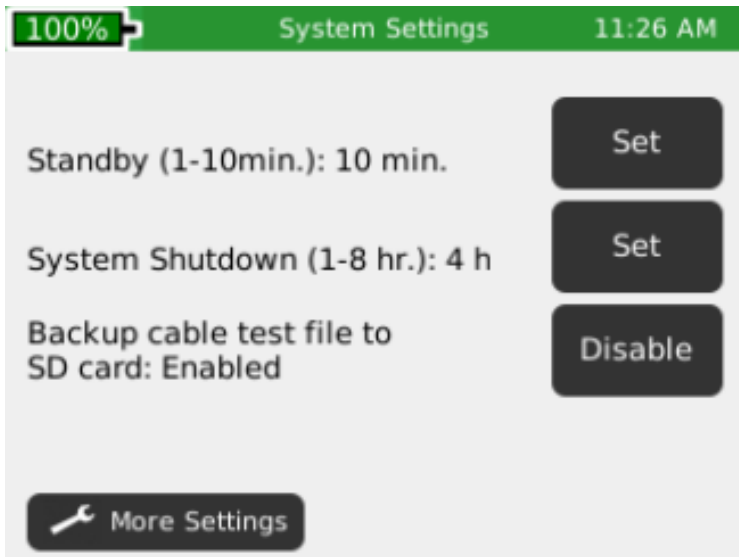
Fifth Systems Settings Screen: Timeout Settings



- To set Standby power down:
 - Touch Set to the right of Stand-by (default is 10 min).
 - Enter a whole number from 1-10 for the number of minutes then touch **OK**. To cancel, press the Back button .
- To set System Shutdown Time:
 - Touch Set to the right of System Shutdown (4 hours is the default setting).
 - Touch the number between 1 and 8 for the hours before system shutdown then touch **OK**. To cancel, press the Back button .
- To configure .tst file backup to SD, touch Disable/Enable. This allows the test files to be saved to the SD card in the event of critical memory loss.
- To continue, touch More Settings or press the Settings button .

Sixth Systems Settings Screen: User Information

- The User Information screen allows the user to enter Company name, user's name, and email to be included on the Net Chaser test reports.



- Touch Set Company and use the keypad to enter the company name (Max 20 Characters) then touch **OK**.
- Touch Set Name (Max 20 Characters) and use the keypad to enter a name then touch **OK**.
- Touch Set E-mail and use the keypad to enter an email address then touch **OK**.
- Touch Set Phone and use the keypad to enter a phone number (20 characters maximum) then touch **OK**.
- To include a company logo, copy the desired image (jpg files only) from your computer to the Logo folder on the Net Chaser SD card. The jpg image size cannot exceed 586x163 dpi. Touch the "Enable/Disable" button to include the company logo.

NOTE: If the SD card does not have a logo folder, right click in the SD Card dialog box and click on a new folder. Name the new folder "logo".

- To continue, touch More Settings or press the Settings button .

Seventh Systems Settings Screen: Firmware

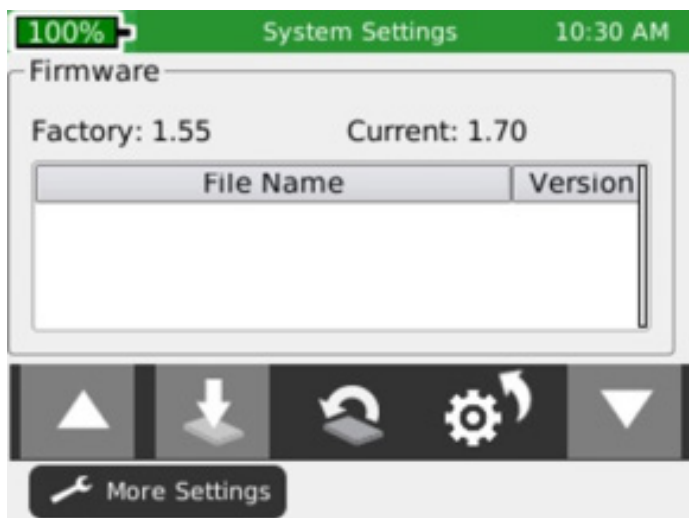

You can have more than one version of firmware on the SD card – all firmware files on the SD Card will be displayed on this screen. Use the Up ▲ and Down ▼ buttons to scroll through multiple firmware files.

- The factory installed firmware revision (default firmware) is displayed above the firmware file table.
- The current firmware revision that is being used is displayed above the firmware file table Current x.xx.

How to update the Net Chaser Firmware



Warning! Do not update the firmware if the battery charge is less than 20%, unless the Net Chaser is plugged into A/C power.

- Go to <http://www.platinumtools.com/support/software-updates/>
- Download the firmware file to your computer. Take note of where the Firmware file is saved.

Upload firmware using the SD Card:

- Remove the SD Card (located on the left side of Net Chaser) and insert it into your computer using an SD Card reader. Your computer will recognize the SD Card as a removable drive. Open the removable drive folder and copy the firmware file(s) from your computer to the removable drive window. Image files may be included as part of the update, be sure to copy all files from the firmware update folder to the SD card. Re-insert the SD Card into the Net Chaser.
- Proceed Installation; “Net Chaser Update” below to install complete the update.
- * **NOTE:** When installing SD Card with firmware update refresh the firmware table by exiting and then reentering the firmware screen.

Upload Net Chaser firmware using the Micro USB cable:

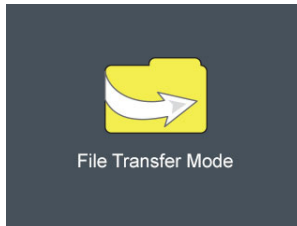

- Plug the included micro USB cable into the Net Chaser then plug the other end of the cable into your computer.
- Touch File Manager  .
- Touch More Options  .
- Touch USB  . The Net Chaser will reboot into File Transfer Mode as shown in the image below.





- The Net Chaser will be recognized by your computer as a removable drive. If your computer does not automatically prompt you to view the removable drive, click on the windows start menu, click on “Computer”, and then double click on the removable drive.
- * **NOTE:** The removable drive may be listed in “Computer” as an SD Card, as the Net Chaser simulates an SD Card reader.
- Navigate to the firmware file(s) that was saved to the computer from. Right click on the firmware file(s) then click on “Copy”. Image files may be included as part of the update. Be sure to copy all files from the firmware update download.

- Navigate back to the Net Chaser removable drive and right click in the removable drive window and click on “Paste”.
- Close the removable drive window then click on “safely remove hardware” on your computers toolbar on the bottom left. Eject “MQX Mass Storage Device”.
- Remove the micro USB cable from the Net Chaser.
- The Net Chaser will automatically reboot. Follow the instructions below to complete the update.



Install Net Chaser Update:

- From the home screen, Touch System Settings .
- Touch More Settings or press the Settings button  until the firmware screen is displayed (7th settings screen).
- Update by touching the firmware file in the firmware table then touch Update Firmware  on the screen. A new screen will appear, confirming that you are updating firmware. Touch OK to continue or Cancel. Another window will appear: Updating firmware.

Press **OK** to continue or Cancel.

- To reset to the factory firmware, touch the Reload Factory Firmware . A new screen will appear, confirming that you are deleting the firmware update and restoring to factory default. You will be prompted to touch **OK** to continue or Cancel to cancel, the Net Chaser will then restart.
- To reset to the factory settings, touch Reset Settings . A new screen will appear, confirming that you are restoring factory Cable Type list. You will be prompted to touch **OK** to continue or Cancel to cancel.

To Update the Bootloader:

- To download the Net Chaser bootloader, visit www.platinumtools.com/netchaserdownloads.
- Download the Bootloader file to your computer.
- For Windows 10, update from SD Card.
- Connect the Net Chaser to your computer using the included USB cable.
- Press and hold the wrench key , then press and release the power button . The Net Chaser will display a solid color on the touch screen and the Link LED will flash. You can release the wrench

key at this point.

- Open the removable drive named “Bootloader”.
- Copy and paste **only the bootloader file** to the removable drive.
- Power off the Net Chaser, unplug it from your computer, and then power it back on.

To Update the PIC firmware:

- To update the Net Chaser PIC firmware, visit <http://www.platinumtools.com/support/software-updates/>.
- Download the Pic update file to your computer.
- Follow “**Upload firmware using the SD Card**” or “**Upload Net Chaser firmware using the Micro USB cable**” instructions on page 18 to upload the PIC update file to your Net Chaser.
- Go to the Net Chaser Firmware Update screen (7th Settings Screen) and touch the PIC update file in the Firmware table.
- Touch the install firmware icon . A new screen will appear, confirming that you are deleting the firmware update and restoring to factory default. You will be prompted to touch **OK** to continue or Cancel to cancel. Net Chaser will then restart.

Eighth System Settings Screen: Firmware/ Hardware Versions

This screen will display which versions of firmware and hardware are in your Net Chaser.

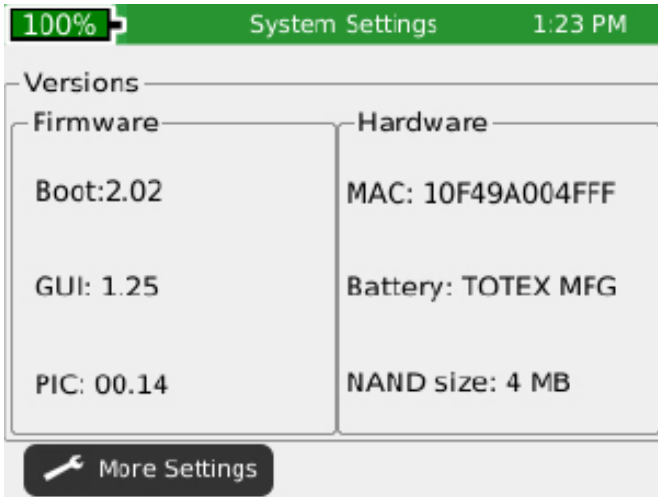



Firmware

- Boot (initializes hardware, loads, and executes operating system)
- GUI (Graphical User Interface)
- PIC (Net Chaser Processor)

Hardware

- Serial Number (Net Chaser MAC Address)
- Module revision (number of your updated module)
- Battery (type of battery)
- NAND size (flash memory in megabytes)

Press the More Settings soft key  to return to the first System Settings screen or press the Home button  to return to the Home Screen.

Active Remote

The Active Remote is used with the Net Chaser to perform a speed certification test. The Active remote can be configured to display 1-4 remote ID's

- Press the Status button to display the battery percentage and the Pass/Fail result of the previous cable test.
- To set the remote ID, remove the battery door screws (see Active Remote on pg.8) and remove the battery door.
- Gently pull out the battery (it is not necessary to unplug the battery to access the ID indicator switch).

WARNING! Do not pull on the battery wires as this may damage the battery. If the battery is removed, use caution as it plugs in one way. Do not force the plug in to the remote as this will damage the plug and/or remote.

- Push the desired ID switch up and push the other keys down (see image below).

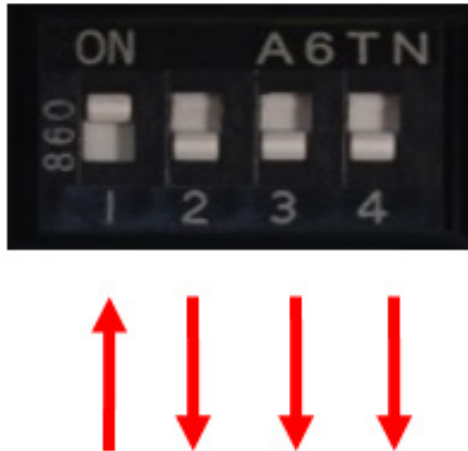

Cable Test

The Net Chaser performs a wire map test, measures cable length using capacitance and TDR, and speed certifies cables up to 1 Gigabit.

Test Options

There are four test options depending on the type of remote being used or if no remote being used. Below are descriptions of the test results given for each test option. To see a full screen view of the results, touch Full Screen





. Press the Back button



to exit the full screen view.

Active Remote:

When an active remote is being used to perform a cable test, the Net Chaser will display the cable wire map, active remote ID, SNR, SKEW, and BER test results. The Net Chaser will display a green check mark  to indicate that the cable has passed the network speed certification test. A VoIP check mark  will also be displayed on the test report. The Net Chaser qualifies cables for use with VoIP if they have successfully transmitted at least 100Mbps.

Network Testing Remote:

When a network remote is being used, the Net Chaser will display the wire map, cable length, ID, and an orange check mark  indicating that the cable passes the wire map test.

Coax Remote:

When using coax remotes, the Net Chaser will display the remote ID. If a short or open is detected, the Net Chaser will measure the distance to the fault.

Open Ended Test

When no remote is being used, the Net Chaser will display the cable length and “Status” for each pair.

ID Only Remote RJ45/Coax

When an ID only remote is being used, the Net Chaser will only show the remote ID on the Detailed Test Results screen. The ID remotes are used to assist with mapping and labeling network cable runs.

Cable Test Overview

Detailed Test Results

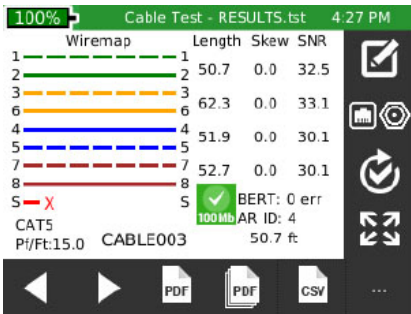





Cable Test List

Type	Jack	Shield	Speed	Pf/Ft
CAT5 STP	RJ45	Yes	100	15.0
CAT5E STP	RJ45	Yes	1000	15.0
CAT6 STP	RJ45	Yes	1000	15.0
CAT6A STP	RJ45	Yes	1000	15.0
CAT7 STP	RJ45	Yes	1000	15.0
RG6	COAX	N/A	0	16.5
RG58	COAX	N/A	0	27.0
NEW TYPE	RJ45	No	100	20.0

The Cable Test  menu saves all tests to internal memory and to the SD card, except when using ID only remotes, to a file with the extension “.tst”. If the SD Card is not inserted into the unit, a warning will appear upon entering the Cable Test Screen; “AutoSave cable test to SD enabled but SD card not found”. See 5th Systems Settings screen to Enable/Disable auto save to SD.

The Cable Test has two screens; a Detailed Results screen and a spreadsheet-like Test List screen. Testing can be initiated from either screen by pressing the Test button . When initiating a test from the Test List Screen, only a summary of the results is shown. If no test file is defined by the user, “UNTITLED1.TST” will be used to save test results to. The test file name that is being used appears in the title bar along with the current function, Cable Test.



To navigate from the Detailed Results screen to the Test List, touch List  at the bottom of screen. If the List icon is not displayed at the bottom of the screen, touch more options on the bottom right of the screen . The Test List will be displayed with a highlighted cable test in the list which the Detailed Results screen was displaying results for. To navigate from the Test List to the Detailed Results screen, highlight a cable test in the list that you would like to display the test details for and touch Select  at the bottom of the screen. To exit the Test List without making a selection, press the Back button .

Before testing a cable, the list file should be selected or created to save results to. The cable type should be selected or created from the cable type list and the cable name prefix and beginning index number can be defined

or kept as default. Each test performed will use the currently selected test definition.

Note: All these test setup functions are on the Detailed Results screen.



Cable Test Setup

From the home screen, touch Cable Test . If the list screen is displayed, touch Select  at the bottom of the screen or the Back button  to go to the Detailed Results screen:



Creating a New Test List:

Touch New File  at the bottom of the Detailed Results screen, enter a file name (20 characters max.), and touch **OK**. Returns to Detailed Results screen. Test List name will appear in the title bar. See File Manager section on page 38 for additional File manager instructions.



Opening a Test List:

If a Test List (.tst) file already exists, it can be selected from a directory list, by touching File Manager . The file manager screen will open showing the internal memory directory of TST files. Touch to highlight the desired file in the list and select File Open  to open the test list and return to the Detailed Results screen.



Selecting a Cable Type:

Touch Cable Type  on the right-hand side of the Detailed Results screen. A list of defined cable types will be displayed with a scroll bar on the right-hand side. If the cable type to be used is in the list, highlight it by touching the line and touch select  to make it the current cable type and return to the Detailed Results screen. See Cable Type section on page 26 for instructions to edit, add or delete cable types.

Setting Cable ID Names:

 The cable ID naming convention is a prefix plus an incrementing three digit index number. The prefix should be limited to 9 characters. With the three digit index there will be a total of 12 characters in the name. From the Detailed Result screen, touch Edit  on the right-hand side of the Detailed Result screen.

The Cable Test Setup screen will appear with the current values for prefix and index displayed. Touch Edit  to the right of the value to be changed, type in new name or index and touch **OK**.

To add up to 200 cables to the test list at once, touch add , and enter the number of cables to add and then touch **OK**. Touch Save  to keep the edited values or touch Cancel  to exit without saving.



Cable ID's can also be edited from the Test List to be any 12 character name, with or without numbers. See the Test List section on page 30 for instructions on editing, adding and deleting cables.

WARNING! Each cable test file (.tst) refers to the cable type definition when creating a test list. If a cable type is edited, the existing test results in the test will be updated with the edited values, such as 2 or 4 pair tests and capacitance value. Be sure to edit an existing cable type prior to testing or simply create a new cable type.

Cable Type

The cable type list contains a list of all the defined cable types to be tested. Cable type list is used to select the test criteria for cables to be tested and manage the list by editing, adding or deleting entries.



New Cable Type

- From the Cable Test Screen, touch Cable Type .
- To add a new cable type, touch New .
- Enter cable name on next screen and press **OK**.
- Touch test connector “RJ45” or “Coax” and press **OK**.
- Touch a data rate (100 Mbps, 1 Gbps, 2-pair 100Mbps, or 0 Mbps) for a Bit Error Rate test and touch **OK** (coax skips this step).
- Enter length constant in pF/foot or pF/meter and press **OK**.
Typical cable length constants (pF/ft, pF/m):

Cable Type	Cable Length Constants
CAT5/5E	15 pF/ft
CAT6	15 pF/ft
CAT7	15 pF/ft
RG6	16.5 pF/ft
RG58	27 pF/ft
RG59	16.5 pF/ft

- Touch Shielded cable, Non-shielded Cable, or Ignore Shield then touch **OK**.





Edit Existing Cable Types

- Touch a cable type from the Cable Type list. With a line highlighted, the buttons functions are:
- Touch Edit  to edit the highlighted entry. The name may be changed or kept default. All other settings are entered as in New Cable Type.
- To delete highlighted entry, touch Delete .
- Touch **OK** to confirm action or cancel.

Select a Cable Type to Test

- Touch a cable type from the Cable Type list. Add the highlighted cable type to the test list by touching Select . The Cable Test screen will appear with the added cable type displayed in the lower left of the screen.





Cable Name

- From the Detailed Results screen, touch edit .
- To enter a cable name prefix touch Edit . The prefix is the first part of the cable name that does not increment when a cable is added to the test list. Enter the desired prefix using the touchscreen keypad and touch **OK**.
- Touch Cable Index  to edit the incrementing numerical portion of the Cable ID. When the desired Index is entered, touch **OK**.
- To accept the changes, touch Save . To exit without saving, touch Cancel .

Ethernet Cable Test

- From the home screen, touch Cable Test .
- Connect an Ethernet cable to the Net Chaser then connect the Active Remote to the opposite end of the cable. If an active remote is not being used, connect a Network testing ID remote to the opposite end of the cable.

* **NOTE:** If testing an Ethernet cable that is terminated to a wall plate, use the included RJ45 patch cables to connect to the wall plate or modular RJ45 jack.





- Touch Cable Type .
- Touch the desired cable type from the cable type list and then touch select Type .
- Press the Test button  to perform a test. The Net Chaser will add an incremented cable name to the Test List and perform a test.
- To perform another test, press Test button . The Net Chaser will add another cable to the test list and perform a test.
- To re-test another cable test, touch the left or right arrows to navigate to the desired cable test then touch Retest .

Calibration

- To calibrate the length measurement to 0ft, touch Edit from the Cable Test screen  to enter the Cable Test Setup. Be sure to remove connected cables unless a patch cable is being used. Touch Coax Connector or RJ45 Connector.
- To calibrate a patch cable to 0ft, connect a patch cable to the Net Chaser then select Coax Connector or RJ45 Connector.

* **NOTE:** The maximum 0 length calibration is 10ft or 150 picoFarads.

Coax Cable Test:

- Connect the included F81 barrel adaptor to the Net Chaser module and then connect a Coax ID Remote to the opposite end of the cable
- From the Home Screen, touch Cable Test .
- Touch Cable Type .
- Touch the desired coax cable type from the cable type list then Select .
- Press the Test button  to perform a test.

Cable Faults



Below are the types of cable faults that the Net Chaser will detect and display if the cable under test is damaged or faulty:

Open: The wire(s) is not continuous throughout the cable. This may be caused by improper termination or a break in the cable.



- Short:** Two or more wires in the cable are connected. This may be caused by an improperly terminated cable, damaged RJ45 plug/jack, or a damaged cable.
- Miswire:** Cable's wire connection does not follow TIA568A/B Ethernet cabling standards. This occurs when there is an error made when terminating the cable.
- Split:** The cable has been wired with correct continuity but not with correct circuitry pairing. This most often happens when the cable is terminated consistently at both ends but in the wrong order.
- Skew:** The delay skew is higher than 35 nanoseconds. This may be caused by velocity of propagation or length difference between the cable pairs.
- SNR:** The Signal to Noise Ratio is lower than 22db. This may be caused by attenuation, excessive crosstalk, or noise that is imposed on the cable from an external source such as electrical cabling, fluorescent lighting, or electrical equipment.
- Length:** The Net Chaser will fail an Ethernet cable when performing a speed certification test if the cable length exceeds 328 feet or 100 meters.
- BERT:** The Net Caser performs a Bit Error Rate Test to ensure error free data transmission. A BERT of up to 1 Gig is performed using 10 Gigabytes of data. The test will fail if it detects more than 3 errors.

Saving Cable Tests as a PDF

In the Detailed Results screen there are two options; the Net Chaser can save the last cable test results as PDF, or the entire test list can be saved as a report.



- From the Detailed Result screen, touch More Options .
- Touch PDF .
- Enter the desired file name for your test and touch **OK**.
- Net Chaser will save the PDF under your new file name to external memory (SD Card).

Saving a PDF Report

- From the Detailed Results screen, touch More Options .
- Touch the PDF Report  on the Cable Test screen.
- Enter the desired file name for your test report and touch **OK**.
- Net Chaser will save the PDF under the new file name to external memory (SD Card).

Saving the Test List as a CSV file









The test list can be saved as a CSV file to be opened with excel or CSV compatible software.

- From the Cable Test screen, touch More Options .
- Touch CSV .
- Use the keypad to enter a file name then touch **OK**.
- The CSV file will be saved to external memory (SD Card).

**** DO NOT REMOVE SD CARD UNTIL DIALOG BOX
DISAPPEARS ****



Test List

The Test List screen contains a list of cables that have been tested. The Test List allows the user to view, save, retest, add, or edit cable tests.

- From the Cable Test screen, touch Test List .
- Touch the Up and Down arrows   to scroll through the cable test list.
- To edit the cable name of an existing cable test, touch edit .
- Use the keypad to enter a new cable name then touch **OK**.
- To add a cable from the test list screen touch Add .
- Touch **OK** to accept the automatically incremented cable name or use the keypad to enter a new cable name then touch **OK**.
- To delete a cable from the test list touch Delete .
- To retest a cable from the test list, touch a cable from the list, touch select  then touch retest . Pressing the test button again will add a new cable to the test list and a test will be performed. The test list can have up to 256 cable tests. If you will be testing more than 256 cables, create a new Test List to continue testing (see “Cable Name” on page 27 for instructions on how to increment the cable name).

Create a new Test List

When a Test list is created, The Net Chaser automatically saves your test list as a .tst file to internal memory. The .tst file can be transferred to an SD card or computer. TST files can be reopened by a Net Chaser for editing, retesting, or adding new tests.

- To create a new .tst file, touch Cable Test  from the home screen.
- Touch New File  and enter a file name then touch **OK**. The .tst file will be saved to internal memory.

File Manager

- From the Cable Test screen touch File Manager .
- File manager contains tst, pdf, and csv files that have been saved to internal or external memory. See “File Manager” on page 38 for File manager instructions.



Link Test

The Link Test menu displays port services provided by an active switch, router, or NIC.



- From the home screen, touch Link Test .
- Touch the desired Link Test option.

Port Discovery

The Port Discovery test will display port services and capabilities such as link speed, MDI/MDI-X, auto negotiation, and SNR of each pair within the cable.





- Port Discovery is the default Link Test option.
- Press the Test button  to perform a Port Discovery test.
- Touch PDF  to save the Port Discovery test results.
- Use the keypad to enter a file name then touch **OK**.

POE Test

- The detailed POE test displays POE mode, type, and min/max load.
- From the Link Test screen, touch POE .
- Press the Test button  to perform a POE test.
- Touch PDF  to save the POE test.
- Use the keypad to enter a file name then touch **OK**.





Tone

The tone generator will transmit a frequency onto a cable to be made audible using a tone probe. The tone generator will assist in locating an inactive cable in a bundle, patch panel, or wall plate.

- From the Link Test screen , touch Tone .
- Press the test button  to transmit the tone.
- Touch Previous  or Next  to alternate which pin or pair to transmit the tone.
- Touch Low/High to change the tone output level and cadence (default is set to low).
- Use a tone probe to trace the tone alongside or at the end of the cable.

Link Light





The Link light blinks the port LED on a switch or router to identify which port the Net Chaser is connected to.

- Connect the Net Chaser to a cable that it plugged into an active hub, switch or router.
- From the Link Test screen , touch Link Light .
- Press the Test button . The Link Light graphic will begin to blink indicating that the test is running.
- The LED of the port you are connected to on a switch or router will blink at a slow and consistent cadence for easy identification.
- To select the Link speed, touch the Left  or Right arrows . The Link Light can be connected at 10Mbps half or full duplex, 100 Mbps half or full duplex, 1Gbps half or full duplex or auto.

BERT Test



The BERT Test will allow you to manually perform a Bit Error Rate Test without regard to TIA wiring specifications such as length maximum and pinout. This will allow you to identify if a cable can support 100Mbps or 1Gbps using up to 250 Gigabytes of data.

- From the Link Test screen , touch More Options .
- Touch BERT 100Mb to perform a 100MB test or touch 1Gb to perform a 1Gb test.
- Touch the left  or right  arrows to select the amount of data to transmit. The amount of time it takes to test is displayed in seconds under the data amount to transmit.
- To save the BERT Test, touch the PDF icon , enter a file name, and then touch **OK**.

Network Test

The Network Test menu provides advanced network tests to discover, verify and troubleshoot the network.

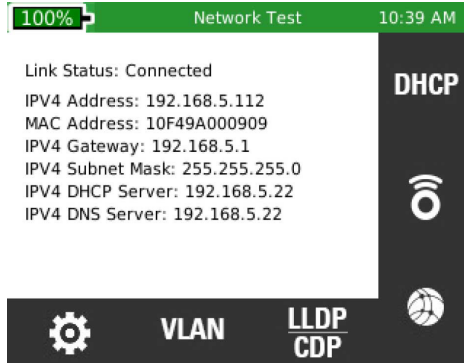

- From the home screen, touch Network Test .
- The Net Chaser will automatically establish a link upon entering the Network Test screen.



Link Test







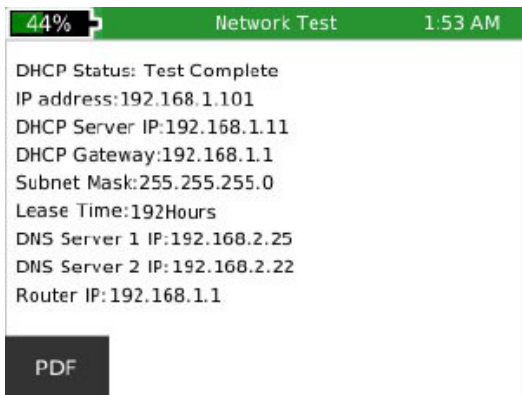

Upon entering the Link Test screen, the Net Chaser will automatically perform a port test by acquiring an IP address and DHCP information.

DHCP

- Touch DHCP  from the Network test screen.
- Press the Test button .
- To save the DHCP test results, touch PDF  on the lower right of the LCD screen. Enter a file name then touch **OK**.



Ping Test



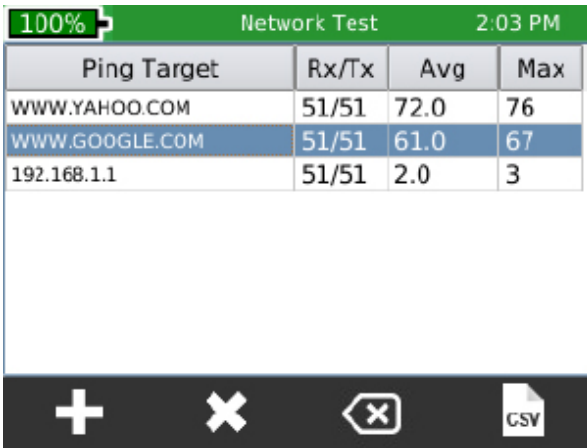

- Connect the Net Chaser to an active Ethernet port or cable.
- Touch Ping  from the Network test screen.
- Touch Add . The saved target list will be displayed.
- Touch add  or Edit  to enter a new IP address or URL.
- Use the keypad to enter an IP or URL
- To edit or remove an address, touch an address under “IP/URL” then touch Edit  or Delete .
- To add an IP address or URL to the target list, touch an address under IP/URL then touch Add .
- To ping the Targets, press the Test button .
- To stop the ping test, press the Test button .





Trace Route



Ping Target	Rx/Tx	Avg	Max
WWW.YAHOO.COM	51/51	72.0	76
WWW.GOOGLE.COM	51/51	61.0	67
192.168.1.1	51/51	2.0	3





Trace route is an ICMP ping test that shows much more detail than a regular Ping Test. Choose a target and each device along the route to the target will be displayed with a corresponding hop number. The largest hop number will be the destination. If a device does not respond to ICMP dashes will be shown next to the hop number. Three pings will be sent to each hop and the response times will be shown.

- From the Network Test screen, touch Trace Route .
- To Add/Edit trace route IP addresses, touch List .
- To delete an address, touch Delete .
- To add an IP address or URL, touch Add .

- To edit an IP address or URL, touch Edit .
- Use the keypad to add or edit the IP address or URL then touch **OK**.
- To add an IP address or URL to the trace route test, touch the desired address from the list and touch Select .
- Press the Test button  to begin the Trace Route test.
- The Net Chaser will display the hop number, IP address, and response time. If a device does not respond with an IP, the Net Chaser will display dashes “- - - -” for that device.
- To save the Trace Route test list, touch CSV .
- Use the keypad to name the CSV file then touch **OK**.





100% Network Test 2:04 PM					
Hop	IP	Time 1	Time 2	Time 3	
15	216.115.100.26	86ms	87ms	190ms	
16	216.115.100.31	83ms	86ms	85ms	
17	98.139.232.83	87ms	82ms	87ms	
18	98.139.128.81	87ms	84ms	88ms	
19	98.139.129.179	83ms	83ms	87ms	
20	98.139.183.24	84ms	84ms	84ms	

Target: WWW.YAHOO.COM

VLAN



The Net Chaser identifies Virtual Local Area Networks and displays them in a list for easy identification. The list will include the VLAN ID and Priority.

- From the Network Test screen, touch VLAN . The Net Chaser will automatically list the available VLAN's.
- Use the Up  and Down  arrows to scroll through the VLAN list.
- To save the VLAN results, touch CSV .
- Use the Keypad to name the CSV file then touch **OK**.



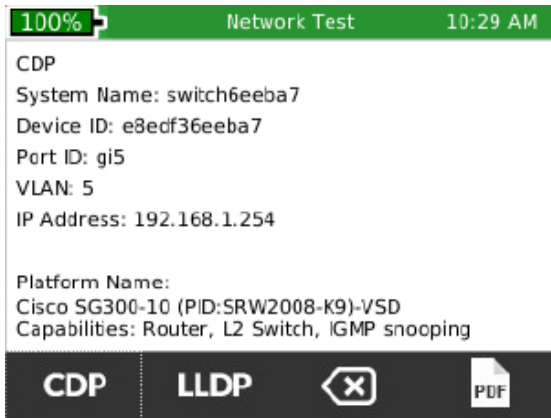

Discovery Protocols

The Discovery Protocol menu provides Cisco switch Protocol and Link Layer Protocol information.



- Connect the Net Chaser to an active Ethernet port or cable.
- Touch CDP/LLDP .
- Touch CDP  to display Cisco switch information.
- Touch LLDP  to display Link Layer switch information.

NOTE: the information displayed may vary depending on the information provided by the switch.

- Touch the left  or right  arrows to view additional CDP or LLDP devices that may be present on the network.
- Touch Clear  to clear the CDP or LLDP screen.
- To save the results, touch PDF .
- Use the keypad to enter a file name then touch **OK**.

NOTE: CDP/LLDP information is obtained from a broadcast packet from a switch or switches on the network. The time between packets is a switch setting and can be in excess of 30 seconds or tuned off. Usually, only managed switches support CDP and or LLDP.













IP Settings

Touch IP  to configure the Net Chaser IP setup (see “First System Settings” on page 12 for additional instructions).

File Manager

The File manager contains saved PDF, CSV, and TST test files. In this menu, they can be renamed, deleted, or transferred between internal and external memory.

Managing Files

- From the home screen, touch the File Manager .
- The File Manager displays files from internal memory and external memory (SD Card). Touch Show Internal  or Show SD  to view the desired memory location.
- To display PDF files only, touch PDF .
- To display CSV files only, touch CSV .
- Touch the Up  and Down  arrows to scroll through the file list.
- To copy files, touch one or more files from the list, then touch Copy to SD  or Copy to Internal .
- Touch  for more options.
- To open a .tst file, touch a .tst file then touch Open .
- To delete a file, touch a file from the list and touch delete .

USB Mode (Not Compatible with Windows 10)











































Files can be uploaded to a computer by removing the SD card and inserting it into an SD Card reader, or by plugging the Net Chaser into a computer via USB.

- To upload files from the Net Chaser to a computer via USB, plug a micro USB cable into a computer then into the Net Chaser.
- From the File Manager screen, touch More options .
- Touch USB. A dialog box will appear to confirm the selection. Touch OK to proceed or Cancel to return to the file manager screen.
- Open the removable storage device drive on your computer.
- Double click on the PDF or CSV folders to view the test files.
- Copy the desired files to your computer.

SD Card

Remove the SD Card from the Net Chaser. Push the SD Card inward then release to unlock the SD Card.

Icon Glossary

	Cable Test Menu		Retest
	Link Test Menu		Reload Factory Software
	Network Test Menu		Restore Defaults
	File Manager Menu		Save one Test to a PDF
	System Settings Menu		Save *.tst file to a PDF
	Cable Type		Save *.tst file as CSV
	Add		Ping Test
	Edit		DHCP request
	Edit Index		Trace Route
	Delete		Tone Test
	Select		Blink Link Light
	Page Up		PoE Test
	Page Down		Setup IP Addresses
	Previous		LLDP/CDP Screen
	Next		VLAN
	List		Clear Screen
	File Manager		SD Card/Internal Memory View Toggle
	New File		Copy to SD Card
	Save		File Open
	Cancel		Delete File
	More Options		Copy to Internal Memory
	Full Screen		

Frequently Asked Questions

Q. What are the 4 inch RJ45 dongles in the Net Chaser Kit?

A. They are RJ45 Port Savers (21025). They are to be plugged into the Net Chaser and the Active Remote during testing to prolong the life of the Net Chaser and Active Remote RJ45 jacks.

Q. Why does the Net Chaser display the cable length in red and fail the cable test?

A. The Net Chaser tests to TIA568 A and B interconnect specifications. If your cable exceeds 328ft/100m, the Net Chaser will not perform the speed certification test and fail the cable length.

Q. Whats is a .TST file?

A. The .tst files consist of cable tests that have been performed in each file.

Q. Whats is pF/ft?

A. pF/ft stands for “picofarad per foot”. It is the capacitance length measurement value used by the Net Chaser to measure a cable. The Net Chaser also uses TDR when a short is detected to measure the distance to the short.

Q. What’s the difference between the Link Test and Network Test menu?

A. The Link Test menu identifies port services such as link speed (Port Discovery), PoE, and port location options such as tone generation and link light flashing. The Network Test menu network features include ping, VLAN detection, Traceroute, LLDP/CDP, and DHCP.

Q. How do I get a Firmware update the Net Chaser?

A. To access updates, go to <http://www.platinumtools.com/support/software-updates/>

Q. Why don’t I get DHCP results in the Link Test or Network Test menus?

A. There may be a few of reasons why the Net Chaser cannot obtain DHCP. Make sure that use DHCP and Use DHCP DNS are selected in the settings menu, perform a VLAN test and make sure you are not connected to a tagged VLAN port. If you still do cannot get a DHCP, check to make sure the cable is connected to an active port.

Q. Why does the test report display Pass VoIP?

A. The Net Chaser qualifies a speed certified cable as VoIP capable as it has successfully transmitted at least 100mbps. VoIP requires at least 100mbps

capability to function correctly.

Q. Why won't the Net Chaser display VLAN results?

A. VLAN detection relies on VLAN tagged LLDP or CDP packets. Perform a LLDP or CDP test and if no results are displayed, enable LLDP or CDP on the switch you are testing.

Q. How many cable tests can the Net Chaser save?

A. The Net Chaser can save 10's of thousands of cable tests to internal and external memory combined. Each TST file is limited to 250 cable tests to keep the file size small and to keep the test list from becoming cumbersome to navigate.

Q. Does the Net Chaser detect PoE?

A. Yes, The Net Chaser detects PoE and PoE plus, PoE mode, and min/max voltages.

Q. How do I test unterminated Ethernet cables?

A. The 8-way Alligator Clip Cord Set (TCA015) allows you to test unterminated Ethernet cable. This unique cord set has an RJ45 plug on one end and an alligator clip connected to each wire on the other end. This accessory allows you to make sure cables have not been damaged before you spend the time and money to terminate them.

Q. How do you test an Ethernet cable via Ethernet wall plate/server/router ports?

A. The 12inch Ethernet Patch Cable (TCA016) allows you to connect to an RJ45 plug to test a shielded or non-shielded Ethernet cable.

Q. How do I extend the life of my RJ45 Jack?

A. The RJ45 Port Saver Cable (P/N 21025C) extends the life of the RJ45 jacks on your tester and remote(s). Plug the Port Saver into the tester or remote and then plug the cables to be tested into the RJ45 Port Saver. Continue testing cables with the Port Savers plugged into the tester or remote(s). If the Port Savers become worn or damaged, simply replace them. This prevents downtime and saves money by not having to send your tester in for an RJ45 jack replacement.

Q. How do I test cables with BNC connectors?

A. The F-jack to BNC jack allows you to easily test coax cables that have been terminated with BNC connectors.

Q. Why are the length wrong and split errors on all my cable drops?

A. This issue is most common when punching down cables to a patch panel. Some patch panels reroute continuity through PCB boards, have LED's connected to a pair to identify the presence of traffic, or noise isolators. These features will change the cable characteristics and affect the test results.

Q. What is SNR, and how is it measured?

A. The Signal to Noise Ratio is performed by measuring the signal generated by the far end (active remote/switch). The far end device transmits Ethernet signals by which the Net Chaser measures the quality of the Ethernet signals. If the signal jitter is outside the Ethernet spectrum, it affects the quality of the signal, which is identified as an SNR dB measurement. The Net Chaser will fail the cable if the SNR is below 20dB.

Q. What is SKEW?

A. SKEW is the signal delay between pairs. Excessive delay can cause data to be received in the incorrect order, negatively impacting network performance.

Q. What is BERT, and how does it work?

A. BERT stands for Bit Error Rate Test. The Net Chaser generates data packets equaling up to 10 Gigabytes, then sends the data packets to the Active Remote at 1Gbps. The active remote receives and returns the same data to the Net Chaser. This test ensures successful data transmission at maximum data rate for 1 Gig. The Chaser will fail the cable if there are more than 3 BERT Errors.

Q. Is the Net Chaser Windows 10 compatible?

A. The Net Chaser USB interface is currently not compatible with Windows 10. Windows 10 compatibility will be included in a future update. If using a Windows 10 computer, you can remove the SD Card from the Net Chaser and plug it directly into your computer for Firmware updates, loading a Company Logo, and loading test results to and from your PC. If your computer does not have an SD Card slot, you can use a USB SD Card reader.

Q. Can I purchase additional active remotes?

A. Yes, the Net Chaser Active Remote TAR104 has selectable ID's (#1-#4) so users can have up to 4 remotes with different ID's.

Maintenance

Batteries

- The Net Chaser is powered by a rechargeable Lithium ion battery.
- To charge the battery, plug the charger into the side port and then plug the charger into the power source.
- Net Chaser battery is not user serviceable. In the event you need to remove the battery, unscrew the back panel of the Net Chaser and unplug the battery from the Net Chaser. Be sure to remove all the leads connecting the battery to the device.

NOTE: The advanced Lithium ion battery is designed to last the life of the unit and should not have to be replaced.

Lithium ion batteries are hazardous waste and should be disposed of in compliance with local, state, and federal hazardous waste regulations.

Cleaning

- Use a clean, damp cloth to clean the Net Chaser.
- Before cleaning, disconnect all cables from the Net Chaser. Failing to disconnect cables can damage the device and cause personal injury.
- Do not use harsh cleaners, abrasives, or solvents.
- Storage
- When not in use, store the Net Chaser in the included protective case.
- Do not expose the Net Chaser to high temperatures (above 80°C) or humidity. See the specifications section for temperature I

Customer Service

For technical information, visit www.platinumtools.com. For customer service, email info@platinumtools.com

Contact Numbers: 800-749-5783 / 805-384-2777

Specifications

Length Measurement	Time Domain Reflectometry & Capacitance
Power	<p>Wall Power Adapter: Input 100-240VAC 50/60Hz, Output 12VDC 2.5A, International plug adapters: (NA/EU/AU/UK)</p> <p>DC Input Jack: 10-28VDC, 20 watts max</p> <p>Battery pack: Rechargeable Li-ion rated 7.8V, 5500mAh, initial capacity</p> <p>Battery life - Linked @ 1Gb - 8 hours minimum</p>
Output Connectors	8-Position shielded modular jack (Data), F-coax (video)
Interfaces	Micro USB, SD flash card
Languages	EN, FR, ESP, DEU, ITA
Battery Life	<p>Battery pack - Rechargeable Li-ion rated 7.8V, 5500mAh, initial capacity</p> <p>Battery life</p> <ul style="list-style-type: none"> - Linked @ 1Gb - 8 hours min. - Active, not linked - 20 hours
Altitude	10,000 ft. (3,048 m) operating altitude
Temperature	<p>Operating: -10 to 60°C</p> <p>Storage: -30 to 70°C</p> <p>Charging temperature range: 10°C to 45°C</p>
Humidity	10 to 90% non-condensing
Enclosure	High-strength PC/ABS plastic with UL94 V0 rating with boot
Size	2.41”H x 4.18”W x 9.03”L (6.12 x 10.61 x 22.94 cm)
Weight	With batteries: 1 lb 12 oz
Warranty	1 Year

Warranty Information

Platinum Tools guarantees that its products will be free of all defects in material and workmanship. This warranty extends for a period of 12 months for the Platinum Tools test equipment from the date of manufacture or proof-of-purchase. Accessories and damage to items caused by normal wear or use are not covered by this warranty.

All products deemed defective under this warranty will be repaired or replaced at Platinum Tools' discretion. No further warranties either implied or expressed will apply, nor will responsibility for operation of this device be assumed by Platinum Tools.

Product Registration

Registering your Net Chaser allows you to access support information and receive product updates. Register your products on the Platinum Tools website: www.platinumtools.com/warranty.

Disposal

WEEE Compliant: Prior to disposal of this product, please contact Platinum Tools for proper disposal options.

Returns

Prior to returning any product to Platinum Tools, you must first request a Return Merchandise Authorization Number by contacting the Customer Service Department at 805-384-2777 or by emailing returns@platinumtools.com.

Note: Shipments will not be accepted without this number, which must be clearly marked on the shipping label.

1. Prior to packing, include a copy of the sales receipt if available. Otherwise the date of manufacturer will be used to calculate warranty date.
2. Provide a description of the operational problem with the product(s) being returned.
3. Include a contact name, phone number, and e-mail address.
4. Pack items securely to prevent damage during shipping.
5. Ship prepaid to:
Platinum Tools
2450 Turquoise Circle
Newbury Park, CA 91320 USA

Notes

Notes

*Net Chaser*TM

User Manual

PLATINUM TOOLS[®]

For technical information and customer support, please visit
www.platinumtools.com or send an email to info@platinumtools.com.

Contact Numbers:

Toll Free (US only): 800-749-5783

Toll: 805-384-2777

Address:

Platinum Tools, Inc.
2450 Turquoise Circle
Newbury Park, CA 91320



www.platinumtools.com