

TP01 Series

Multi-Touch Resistive Touch Screens with Smooth, Light Operation



4-Wire Analog Resistive Touch Screens

General Specifications

Power Level	1mA @ 5.5V DC (resistive load)
XY Resistive Value	250 ~ 850Ω Wide Type: 120 ~ 1,500Ω
Linearity	±1.5% maximum
Insulation Impedance	10MΩ minimum @ 25V DC
Expected Operational Life	Writing: 50,000 operations minimum (approximately 30mm movement with stylus) Tapping: 1,000,000 operations minimum (using silicone rubber, hardness 60°)
Touch Activation Force	0.02 ~ 1.0N maximum
Chattering Time	10 milliseconds maximum
Relative Humidity	+40°C (+104°F), humidity 90%, 240 hours
Operating Temperature Range	-20°C ~ +70°C (-4°F ~ +158°F)
Storage Temperature Range	-40°C ~ +80°C (-40°F ~ +176°F)
Light Transmission	80% standard (Touch Panel portion)
Surface Hardness	3H minimum (JIS K 5400 / Pencil Hardness)

Note: Values are determined by NKK's individual specification tests in a controlled environment, and do not certify that the product supports simultaneous multiple conditions.

Applications

- Industrial Automation
- Information Technology
- POS, Cash Registers
- ATMs
- Medical Equipment
- Gaming/Entertainment
- Broadcast
- Food Service

Distinctive Characteristics

- Smooth, light and multi-touch operation on resistive touch screens
- Combining with controller board facilitates multi-touch operation characterized by pinching screen to zoom in, spreading screen to zoom out, rotation, etc.
- Multi-touch touch screens support expanded design capabilities in a variety of sizes and relatively low cost
- Choice of input methods: finger, gloved hand or stylus
- Glare resistant surface reduces reflection from fluorescent lighting, sunlight
- Anti-Newton Ring (ANR) Technology eliminates many of the typical visual artifacts for analog types
- Hard resin coating on film's surface ensures excellent protection against scratches or damage
- Analog touch screen integrated with optional controller board device driver on computer enables operations same as with a mouse by touching screen panel
- Narrow frames available

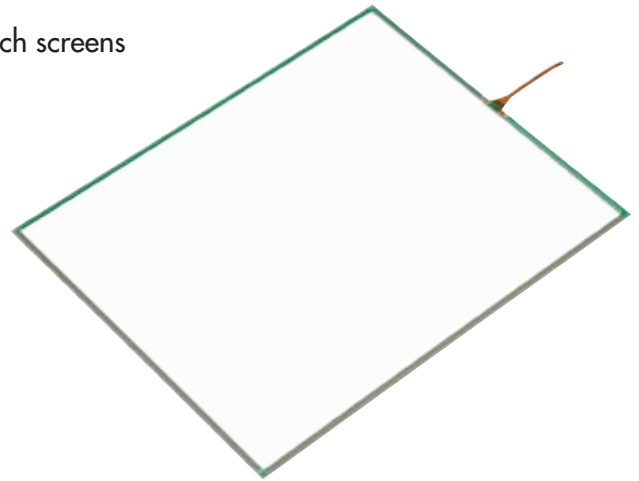

Specializing in Custom Products

- Custom sizes for Resistive Touch Screens
- Capability to attach touch screens to LCDs or other components
- Specializing in custom construction such as film plus film combinations
- Fingerprint resistant, high transmittance films

Cross Section View of Touch Screen

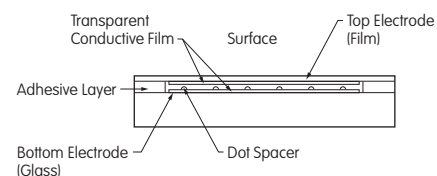

TYPICAL TOUCH SCREEN ORDERING EXAMPLE

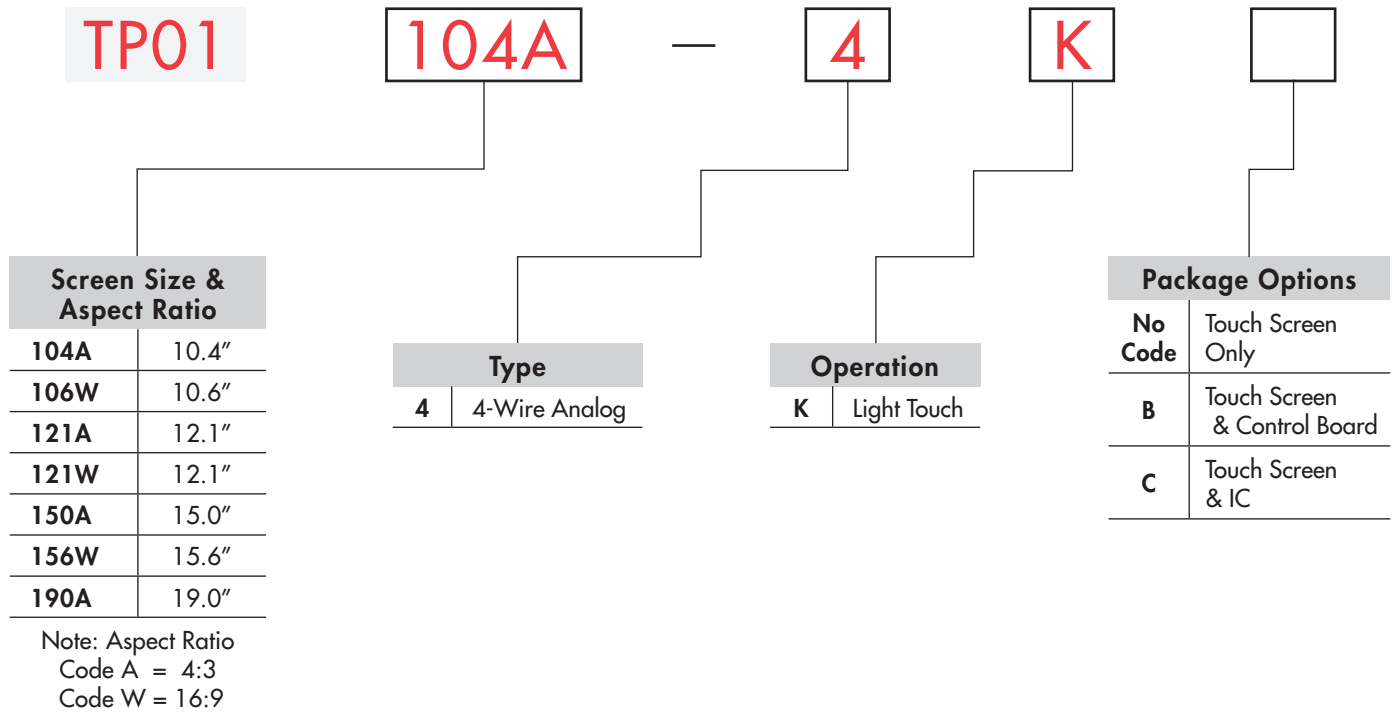





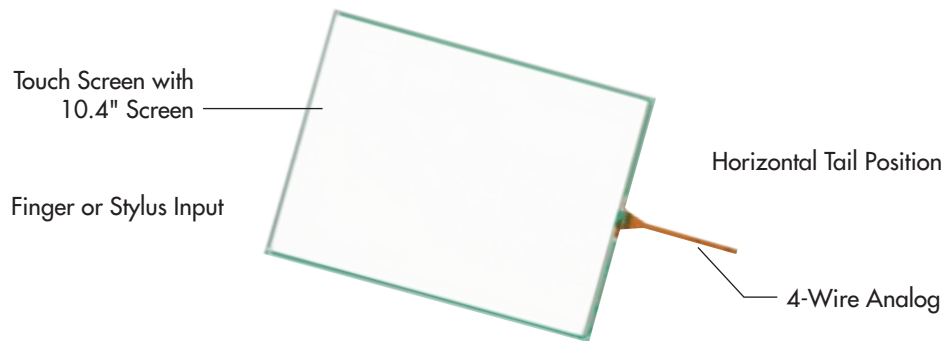

DESCRIPTION FOR TYPICAL ORDERING EXAMPLE

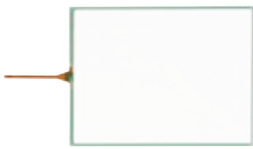
TP01 104A-4K

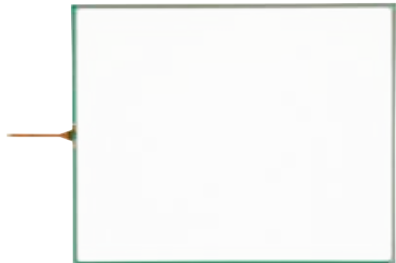

PART NUMBERS & DESCRIPTIONS

			
TP01104A-4K	TP01106W-4K	TP01121A-4K	TP01121W-4K
			
TP01150A-4K	TP01156W-4K	TP01190A-4K	

4-Wire Analog Touch Screens

Part Number	Screen Size in Inches	Key Area Dimensions	Viewing Area Dimensions	External Dimensions	Panel Thickness	Terminal Detail 4 Pin .039" (1.0mm) Pitch
TP01104A-4K	10.4	8.315" x 6.236" (211.2mm x 158.4mm)	8.465" x 6.394" (215.0mm x 162.4mm)	8.882" x 6.748" (225.6mm x 171.4mm)	.083" (2.1mm)	Length 3.150" (80.0mm)
TP01106W-4K	10.6	9.071" x 5.441" (230.4mm x 138.2mm)	9.189" x 5.563" (233.4mm x 141.3mm)	9.756" x 6.094" (247.8mm x 154.8mm)	.083" (2.1mm)	Length 3.150" (80.0mm)
TP01121A-4K	12.1	9.677" x 7.256" (245.8mm x 184.3mm)	9.827" x 7.406" (249.6mm x 188.1mm)	10.236" x 7.795" (260.0mm x 198.0mm)	.083" (2.1mm)	Length 3.150" (80.0mm)
TP01121W-4K	12.1	10.280" x 6.425" (261.12mm x 163.2mm)	10.404" x 6.551" (264.26mm x 166.4mm)	10.827" x 6.929" (275.0mm x 176.0mm)	.083" (2.1mm)	Length 3.150" (80.0mm)
TP01150A-4K	15.0	11.972" x 8.980" (304.1mm x 228.1mm)	12.130" x 9.138" (308.1mm x 232.1mm)	12.669" x 9.665" (321.8mm x 245.5mm)	.083" (2.1mm)	Length 3.150" (80.0mm)
TP01156W-4K	15.6	13.551" x 7.618" (344.2mm x 193.5mm)	13.681" x 7.748" (347.5mm x 196.8mm)	14.276" x 8.433" (362.6mm x 214.2mm)	.083" (2.1mm)	Length 3.150" (80.0mm)
TP01190A-4K	19.0	14.815" x 11.850" (376.3mm x 301.0mm)	15.039" x 12.102" (382.0mm x 307.4mm)	15.571" x 12.638" (395.5mm x 321.0mm)	.083" (2.1mm)	Length 3.150" (80.0mm)

TYPICAL 10.4 DIMENSIONS

4-Wire with Horizontal Tail

Aspect Ratio 4:3

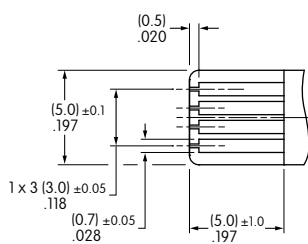
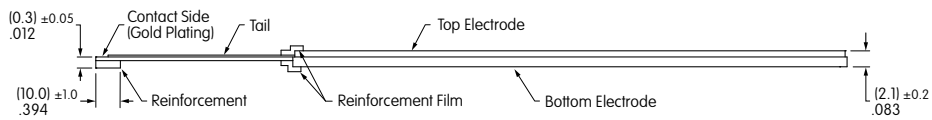
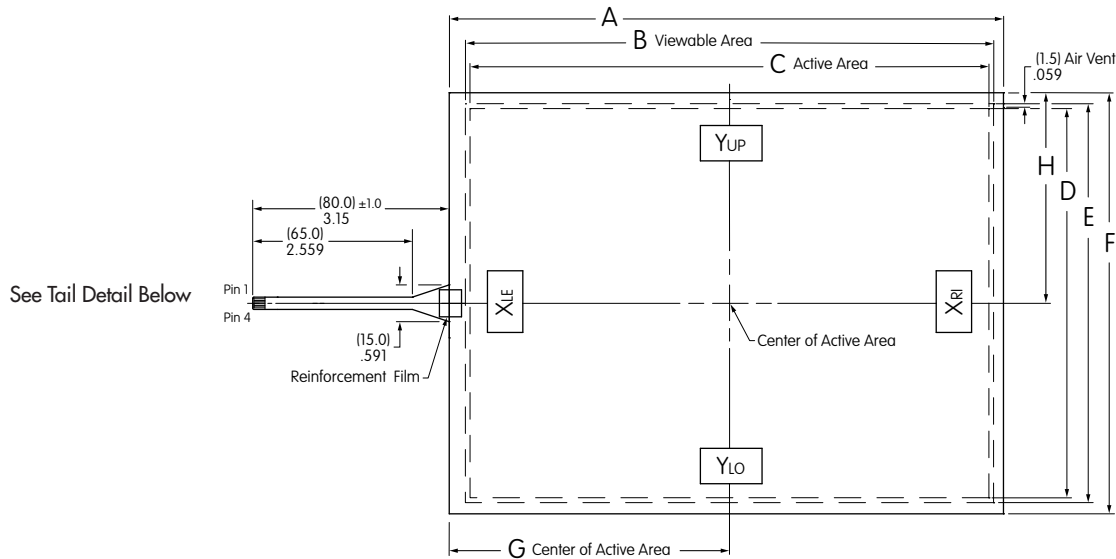

Tail Detail

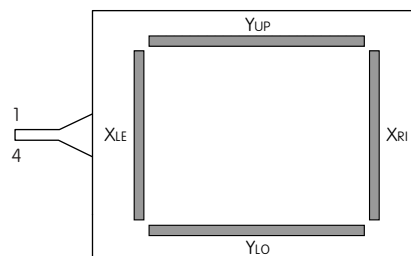

Y_{UP}, Y_{LO}: Bottom Electrode Terminal
X_{LE}, X_{RI}: Top Electrode Terminal

Pins	Signal
1	Y _{UP}
2	Y _{LO}
3	X _{LE}
4	X _{RI}

Typical Dimensions

Part Number	Screen Size in Inches	Dim A	Dim B Viewable Area	Dim C Active Area	Dim D Active Area	Dim E Viewable Area	Dim F	Dim G Center of Active Area (Horizontal)	Dim H Center of Active Area (Vertical)
TP01104A-4K	10.4	8.882" (225.6±0.3mm)	8.465" (215.0mm)	8.315" (211.2mm)	6.236" (158.4mm)	6.394" (162.4mm)	6.748" (171.4±0.3mm)	4.492" (114.1mm)	3.374" (85.7mm)

TYPICAL 10.6 DIMENSIONS

4-Wire Wide Type with Horizontal Tail

Aspect Ratio 16:9

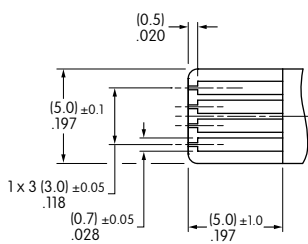
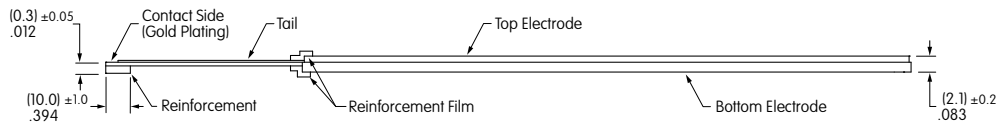
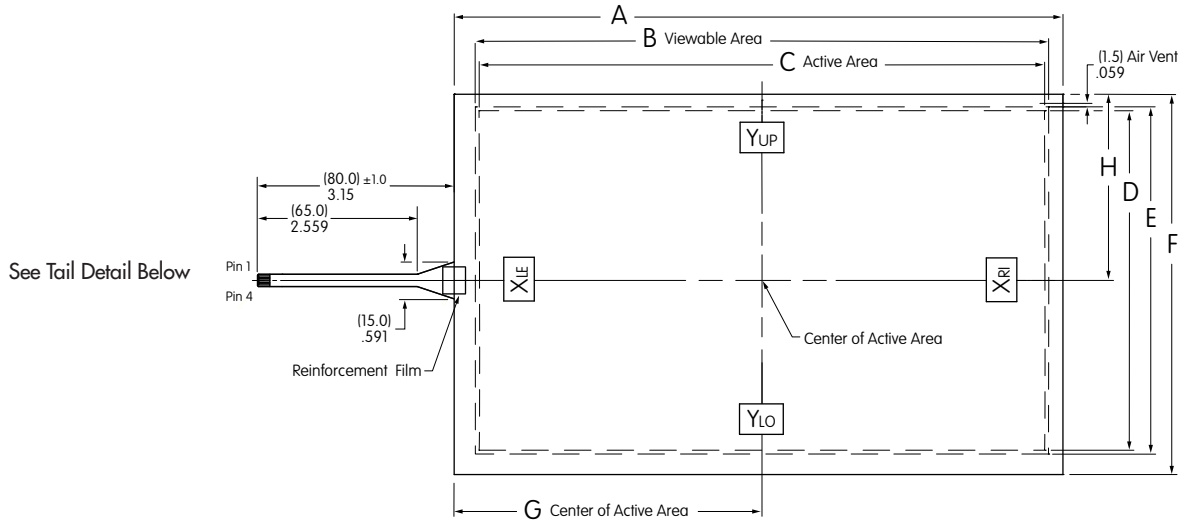

Tail Detail

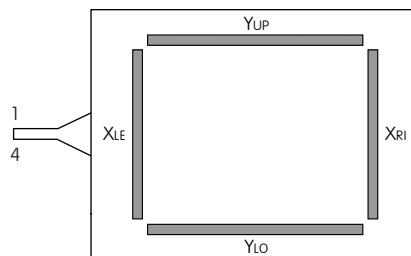

YUP, YLO: Bottom Electrode Terminal
XLE, XRI: Top Electrode Terminal

Pins	Signal
1	Y _{UP}
2	Y _{LO}
3	X _{LE}
4	X _{RI}

Typical Dimensions

Part Number	Screen Size in Inches	Dim A	Dim B Viewable Area	Dim C Active Area	Dim D Active Area	Dim E Viewable Area	Dim F	Dim G Center of Active Area (Horizontal)	Dim H Center of Active Area (Vertical)
TP01106W-4K	10.6	9.756" (247.8mm)	9.189" (233.4mm)	9.071" (230.4mm)	5.441" (138.2mm)	5.563" (141.3mm)	6.094" (154.8±0.3mm)	4.933" (125.3mm)	3.047" (77.4mm)

TYPICAL 12.1 DIMENSIONS

4-Wire with Horizontal Tail

Aspect Ratio 4:3

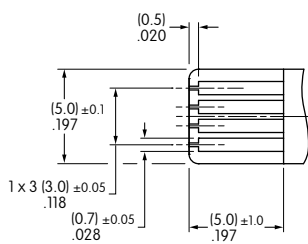
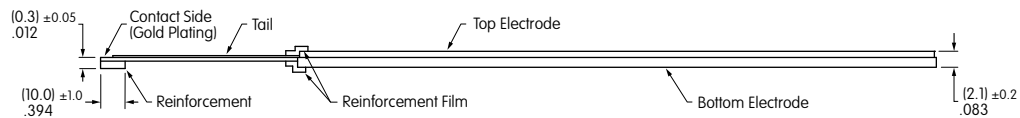
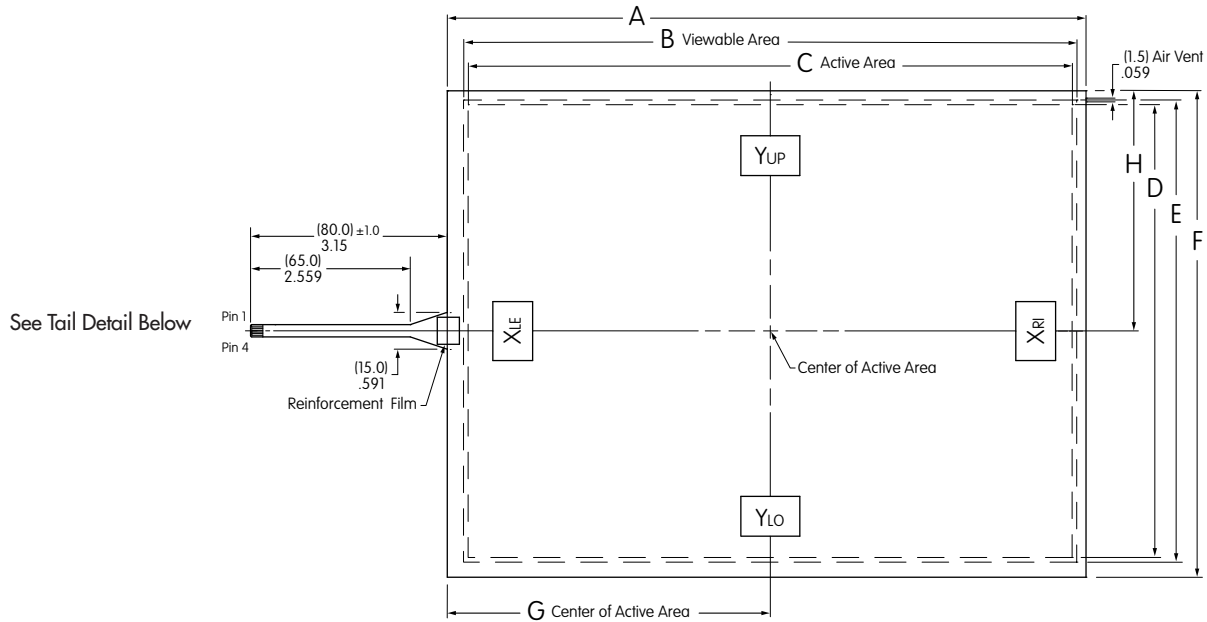

Tail Detail

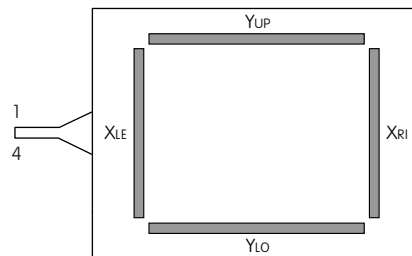

YUP, YLO: Bottom Electrode Terminal
XLE, XRI: Top Electrode Terminal

Pins	Signal
1	Y _{UP}
2	Y _{LO}
3	X _{LE}
4	X _{RI}

Typical Dimensions

Part Number	Screen Size in Inches	Dim A	Dim B Viewable Area	Dim C Active Area	Dim D Active Area	Dim E Viewable Area	Dim F	Dim G Center of Active Area (Horizontal)	Dim H Center of Active Area (Vertical)
TP01121A-4K	12.1	10.236" (260.0±0.3mm)	9.827" (249.6mm)	9.677" (245.8mm)	7.256" (184.3mm)	7.406" (188.1mm)	7.795" (198.0±0.3mm)	5.177" (131.5mm)	3.898" (99.0mm)

TYPICAL 12.1 DIMENSIONS

4-Wire Wide Type with Horizontal Tail

Aspect Ratio 16:9

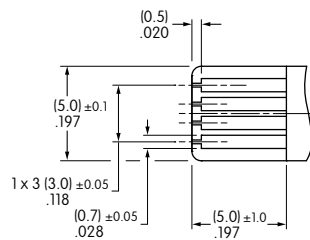
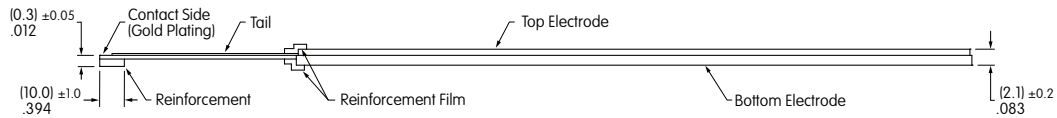
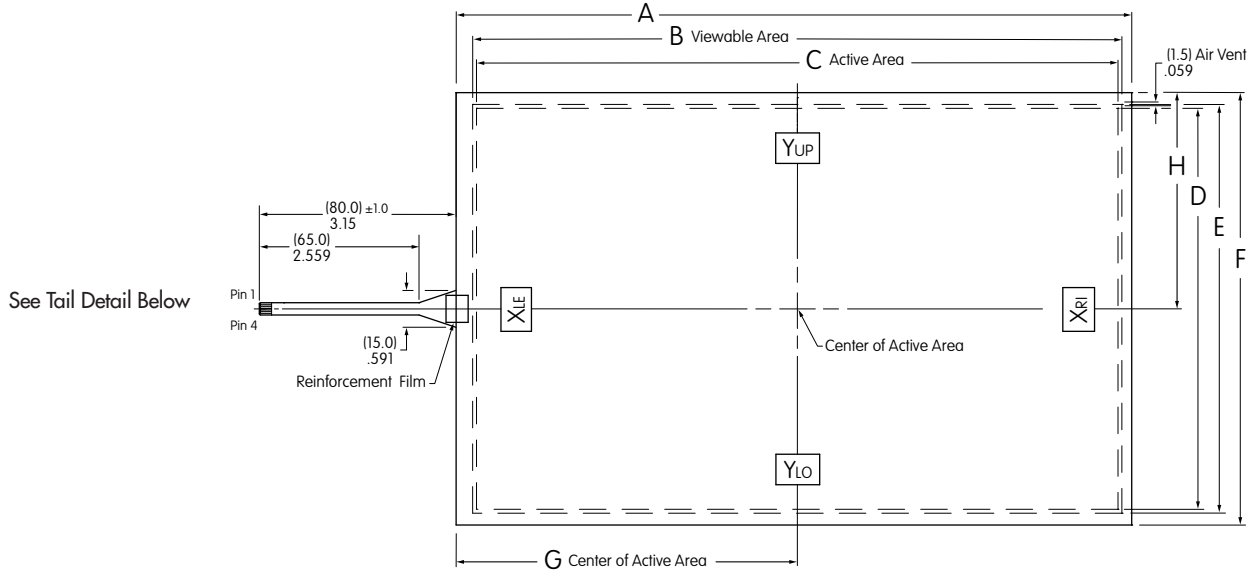

Tail Detail

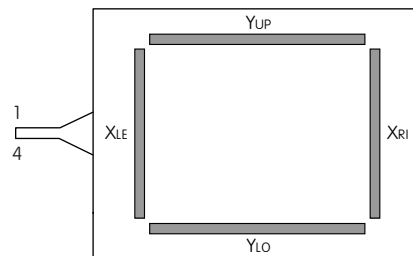

YUP, YLO: Bottom Electrode Terminal
XLE, XRI: Top Electrode Terminal

Pins	Signal
1	Y _{UP}
2	Y _{LO}
3	X _{LE}
4	X _{RI}

Typical Dimensions

Part Number	Screen Size in Inches	Dim A	Dim B Viewable Area	Dim C Active Area	Dim D Active Area	Dim E Viewable Area	Dim F	Dim G Center of Active Area (Horizontal)	Dim H Center of Active Area (Vertical)
TP01121W-4K	12.1	10.827" (275.0±0.3mm)	10.404" (264.26mm)	10.280" (261.12mm)	6.425" (163.2mm)	6.551" (166.4mm)	6.929" (176.0±0.3mm)	5.468" (138.89mm)	3.465" (88.0mm)

TYPICAL 15.0 DIMENSIONS

4-Wire with Horizontal Tail

Aspect Ratio 4:3

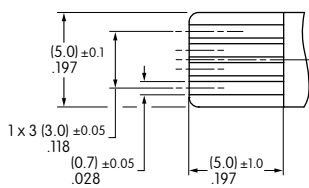
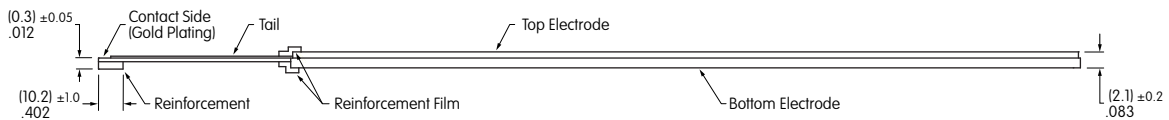
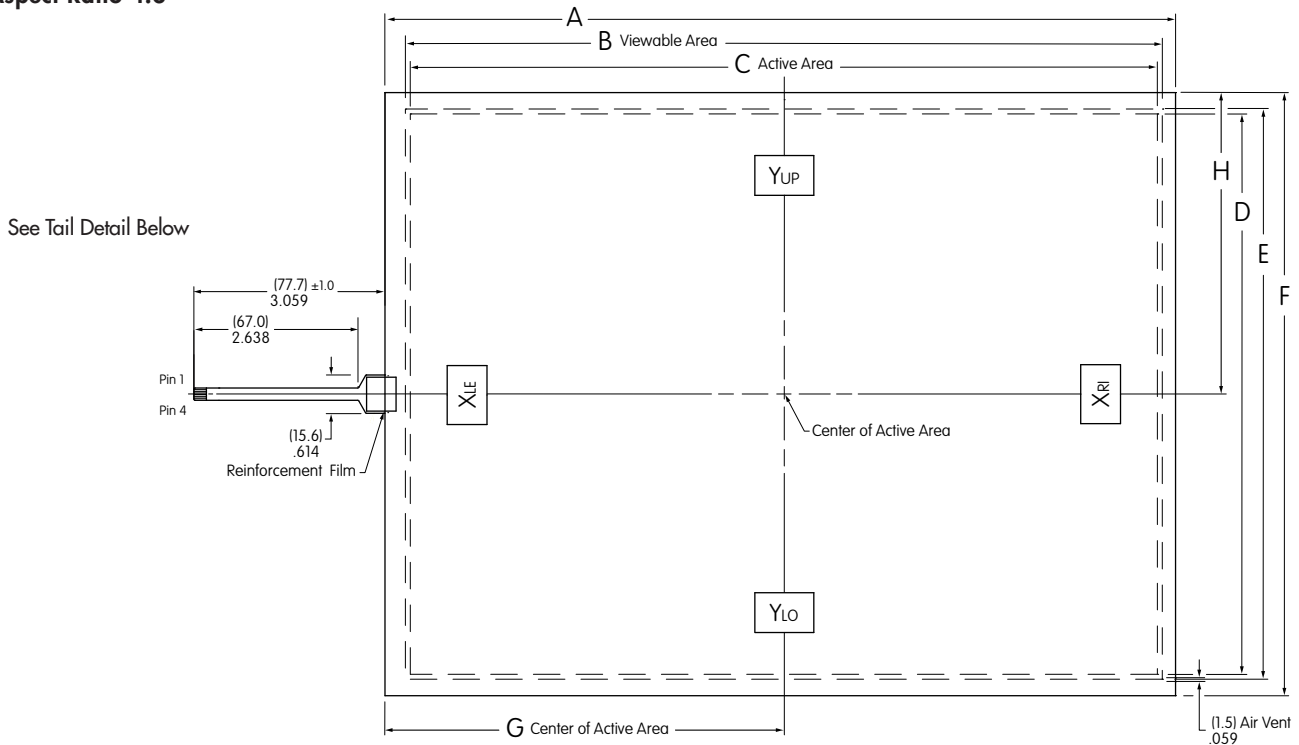

Tail Detail

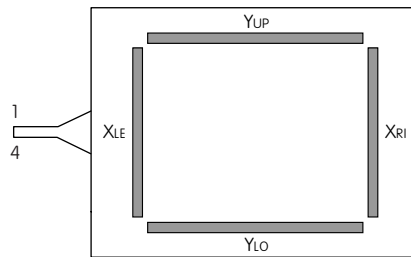

Y_{UP}, Y_{LO}: Bottom Electrode Terminal
X_{LE}, X_{RI}: Top Electrode Terminal

Pins	Signal
1	Y _{UP}
2	Y _{LO}
3	X _{LE}
4	X _{RI}

Typical Dimensions

Part Number	Screen Size in Inches	Dim A	Dim B Viewable Area	Dim C Active Area	Dim D Active Area	Dim E Viewable Area	Dim F	Dim G Center of Active Area (Horizontal)	Dim H Center of Active Area (Vertical)
TP01150A-4K	15.0	12.669" (321.8±0.3mm)	12.130" (308.1mm)	11.972" (304.1mm)	8.980" (228.1mm)	9.138" (232.1mm)	9.665" (245.5±0.3mm)	6.504" (165.2mm)	4.833" (122.75mm)

TYPICAL 15.6 DIMENSIONS

4-Wire Wide Type with Horizontal Tail

Aspect Ratio 16:9

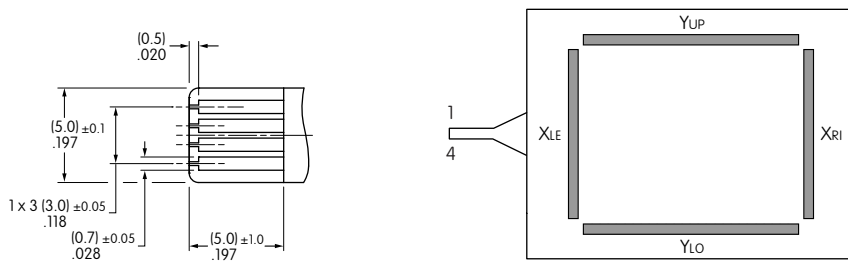
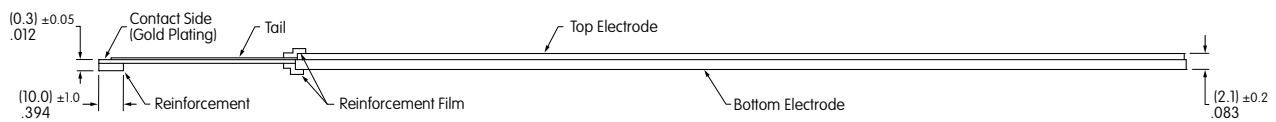
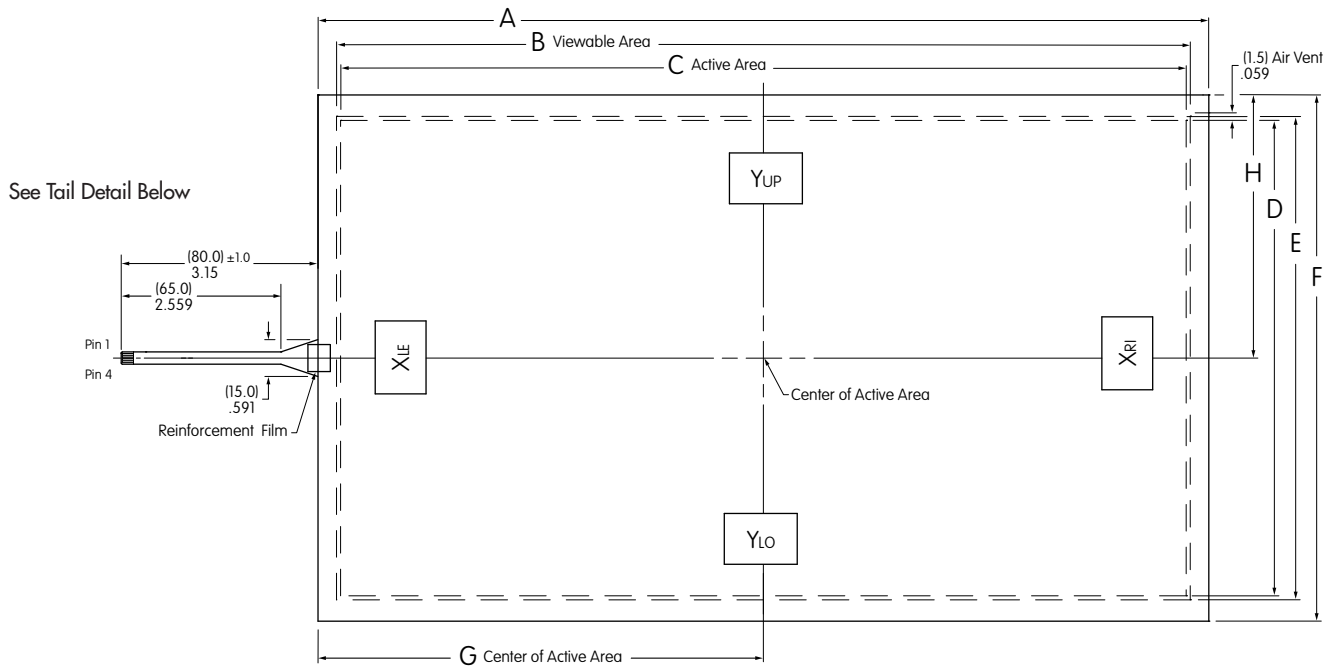

Tail Detail

YUP, YLO: Bottom Electrode Terminal
XLE, XRI: Top Electrode Terminal

Pins	Signal
1	Y _{UP}
2	Y _{LO}
3	X _{LE}
4	X _{RI}

Typical Dimensions

Part Number	Screen Size in Inches	Dim A	Dim B Viewable Area	Dim C Active Area	Dim D Active Area	Dim E Viewable Area	Dim F	Dim G Center of Active Area (Horizontal)	Dim H Center of Active Area (Vertical)
TP01 156AW-4	15.6	14.276" (362.6±0.3mm)	13.681" (347.5mm)	13.551" (344.2mm)	7.618" (193.5mm)	7.748" (196.8mm)	8.433" (214.2±0.3mm)	7.138" (181.3mm)	4.217" (107.1mm)

TYPICAL 19.0 DIMENSIONS

4-Wire with Horizontal Tail

Aspect Ratio 4:3

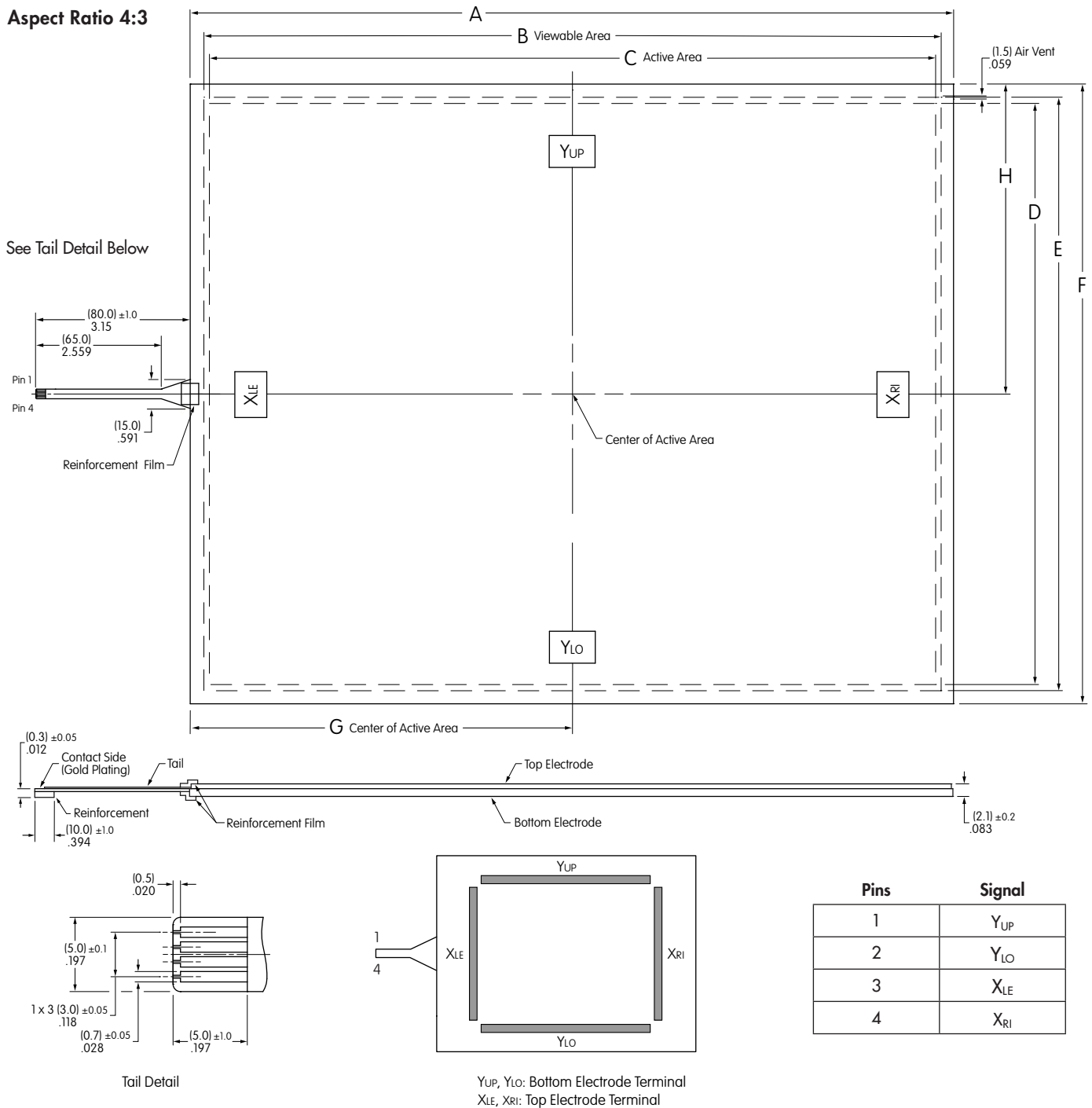

Typical Dimensions

Part Number	Screen Size in Inches	Dim A	Dim B Viewable Area	Dim C Active Area	Dim D Active Area	Dim E Viewable Area	Dim F	Dim G Center of Active Area (Horizontal)	Dim H Center of Active Area (Vertical)
TP01190A-4K	19.0	15.571" (395.5±0.3mm)	15.039" (382.0mm)	14.815" (376.3mm)	11.850" (301.0mm)	12.102" (307.4mm)	12.638" (321.0±0.3mm)	7.799" (198.1mm)	6.319" (160.5mm)

4-Wire Multi-Touch Screen Controller Boards & Drivers

DISTINCTIVE CHARACTERISTICS

- Compatible with Control Board USB
- Device Driver is *Windows 7, 8 & 10 Compatible

System Configuration for USB

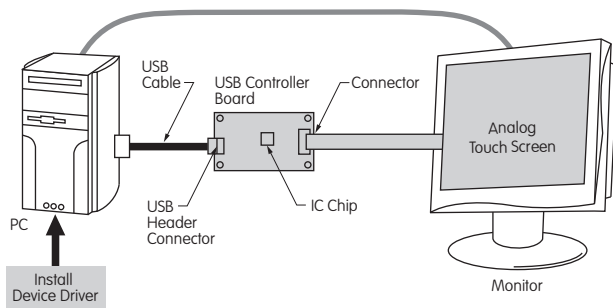

■ Available through NKK Switches

Absolute Maximum Ratings

Items	Symbols	Minimum	Maximum
Supply Voltage	V_{CC}	+4.5V	+5.5V
Input Voltage	V_{TP}	—	V_{CC}
Operating Temperature	T_{OPR}	-20°C (-4°F)	+70°C (+158°F)
Storage Temperature	T_{STG}	-30°C (-22°F)	+85°C (+185°F)

Controller Boards		
Type	Part No.	Communication Protocol
4-Wire	* TP01104A-KB	USB

* Includes any of the Multi-Touch Screen Models

NKK's analog touch panels can be operated the same as PC mouse functions by combining a control board or device driver and analog touch screen. This includes the screen's multi-touch capabilities.

For specifications or technical data for the controller boards and drivers, see NKK's web site or call our engineering support personnel.

NKK offers the option to order a controller board in a package with a touch screen. See ordering table for details.

Recommended Values

Items	Symbols	Minimum	Typical	Maximum	Notes
Supply Voltage	V_{CC}	+4.5V	+5	+5.5V	—
Operating Temperature	T_{OPR}	-20	—	+70°C (+158°F)	No Condensation

IC Chip for Analog Multi-Touch Screens

DISTINCTIVE CHARACTERISTICS

- Interface: USB
- Compatible with *Windows 7, 8 & 10
- High Speed and Accuracy
- Built-in Calibration Function
- Data Function Removal Built In to Eliminate Noise

The IC is for use with the 4-wire transparent touch screens. When the screen is touched, it recognizes the position of the touch by the level of analog voltage detected by the A/D. The A/D converter receives the value and sends a set of coordinate values as serial data or USB.

Contact NKK Switches for the IC data sheet.

NKK offers the option to order an IC chip in a package with a touch screen. See ordering table for details.

*Windows is a registered trademark of Microsoft Corporation.

4-Wire Multi-Touch Screen Controller Board for USB

Controller Board for USB

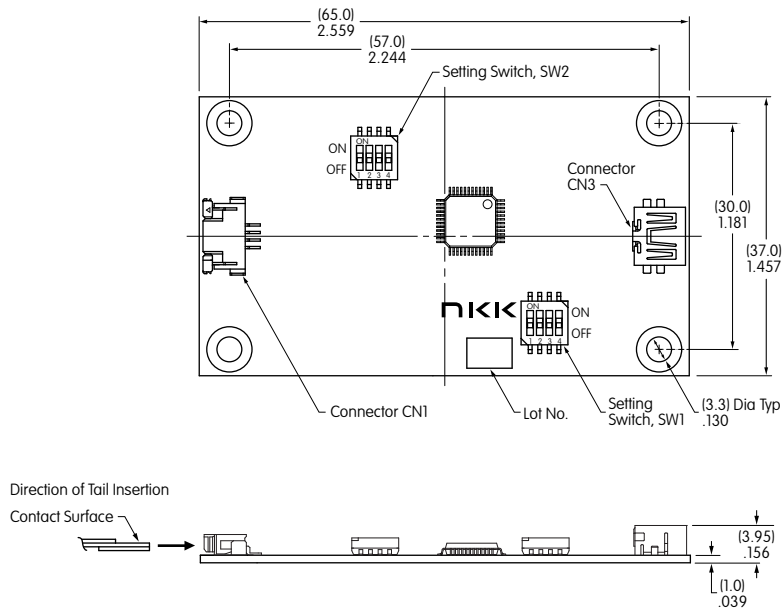

CN1 4-Wire Analog Touch Screen Connector - 4 Pins

Pin No.	Symbol	Description
1	Y _{UP}	Touch Screen Drive Output PSW2
2	Y _{LO}	Touch Screen Drive Output PSW1, PSW5
3	X _{LE}	Touch Screen Drive Output PSW4
4	X _{RI}	Touch Screen Drive Output PSW3, PSW6

CN3 Header Connector for USB - 5 Pins

Pin No.	Symbol	Description
1	V _{CC}	V _{CC}
2	D ₋	D ₋
3	D ₊	D ₊
4	GND	V _{SS} (OV)
5	FG	Shield GND

STORAGE, HANDLING & INSTALLATION

Handling of Controller Board



- NKK Switches cannot guarantee the controller boards if used with other manufacturer's touch panels.
- Products are ESD sensitive and ESD protection is required.
- Power source should be activated after host and touch panel are connected.
- When inserting connector CN1 and touch panel tail, be sure the slider of connector CN1 is pulled. Do not pull more than 10 times.
- Do not customize or alter the product.
- NKK Switches reserves the right to make product improvement changes without notice.
- Do not use any commands other than the ones outlined in the specifications.
- Place the product away from noise source (such as inverter for LCD operation) since tail can be affected by noise.
- NKK is not responsible for results of using damaged equipment with the controller boards.
- Warranty for one year after delivery. NKK warranties the 4-wire touch panel when it is used with the NKK control board and driver.

Installation

- Avoid mechanical stress during installation, as it may cause deformation on the board.
- Do not pull, bend or apply force to the tail. Do not apply any mechanical stress to the tail area.
- Avoid vibration or shock.
- The touch screen mounting should not be loose. This may cause an adverse effect on detecting performance during operation.
- Ensure there are no burrs around the edges of the case or housing that can cause false actuation. The edges of the case or housing should not enter the keying area, as this may cause a malfunction.

STORAGE, HANDLING & INSTALLATION

Installation (Continued)

- The case or housing and upper electrode should have a space of about 0.5mm to accommodate expansion or shrinkage due to temperature variances. If a shock barrier is used, do not press hard on the upper electrode area. Any shock barrier should be installed more than 0.6mm away from point A.

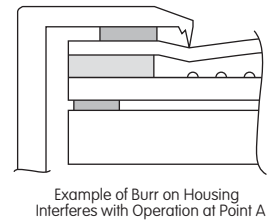
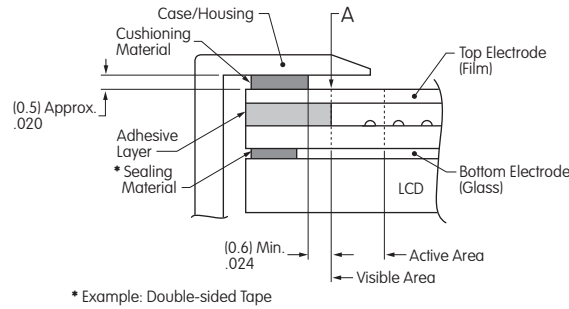

- To secure the touch screen, secure the lower portion with a device such as the LCD display panel. Do not attach the upper electrode with double-sided tape or similar product to avoid stress that can damage the upper or lower electrode.
- In order to balance upper and lower pressure, an air vent may be installed. Ensure that no liquid or oil will enter into the device.
- Moisture from condensation on tail connection or edges may result in migration, causing short circuit failure.
- Remove protective film from the touch screen after installation is completed.

Handling Precautions

- When opening product, take precaution with up/down and front/back directions. Glass edges are not chamfered, and corners or edges can be sharp. Wear gloves when handling the product.
- Do not pick up the product by the tail or pull the tail area.
- Use gloves or finger cots to prevent fingerprints on surface.
- When handling the product, hold it outside of the viewing area.
- Avoid stacking multiple products or placing other items on the product.
- Clean with a soft cloth and ethanol. Do not use any cleaning agents other than ethanol.
- Store product in original package and store at the temperature and humidity range specified.
- Do not store in an environment with acids or other corrosive gases or where condensation may occur.

Operating Precautions

- Operate with fingers or a touch screen stylus only.
- Do not press hard with a pen or similar object between viewing area and key area.

Design Precautions

- With analog type, resistive value change (by aging or individual differences) can dislocate the input area. Input area can be calibrated with software.
- When installing on top of an LCD, noise from the display device can cause misoperation. To avoid noise, implement grounding the display device frame.
- Do not create software for simultaneous touch points, as analog type will read the center point between two touch points.
- When used to draw a line, analog type will have a break at dot spacer. Compensate for this with software.
- Contact resistance may cause chatter depending on pressing condition. Software should detect signal after it stabilizes.

Other Precautions

- Not suited for use in critical control systems without proper fail-safe design consideration.
- Products are guaranteed based on evaluation of standards within the moisture tolerance and usage temperature range, but not guaranteed to operate perpetually at this temperature.
- Calibration data from one touch panel should not be applied to another panel; each should be calibrated individually.
- Recalibration is necessary if connector has been removed from the tail and reconnected.
- All specifications based on the tested touch screens only. Evaluate the products after installation.

ANALOG TOUCH SCREENS

- The analog touch screen has a two-layer structure consisting of polyester film with an ITO membrane and sheet of glass. The surfaces of top and bottom electrodes have a uniform resistive film. One electrode draws in the X-axis direction, the other on the Y-axis direction. When pressure is applied, it changes the resistance value between X1 and X2 and Y1 and Y2, then converts to a digital signal.

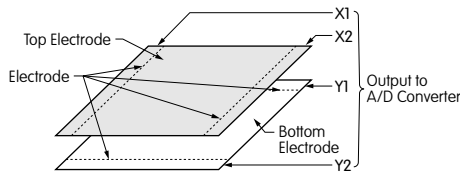

- To interpret the touched position, 5V is applied to the top electrode (X1 and X2). Then the voltage on the arrow direction evenly changes.

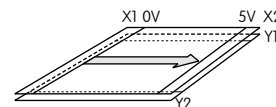

- With a touch to the center of the top electrode film, the touched position contacts the bottom film (glass), and 2.5V is output to Y1 (or Y2). The output signal is then converted to a digital signal and can be recognized as an X-axis coordinate value. In the same way, the Y-axis coordinate value can be read from Y1 and Y2 on the bottom electrode. Then the position where the X and Y axis coordinate value intersected is read as the contact position.

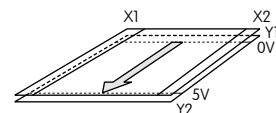

- The resolution of the analog touch screens is relatively higher than the digital models and contributes to the variety of the screen designs available, including those displaying buttons. Since analog types generally detect signals as a point but not as a number on the keys, the signals may be input as text or drawings with a pen. The vertical and horizontal resolution (detection points) is 1,024 when a 10bit A/D converter is used.

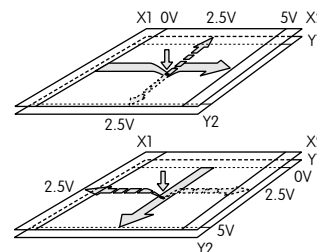

The active area of each button is independent of each other, resulting in no interference between the areas.

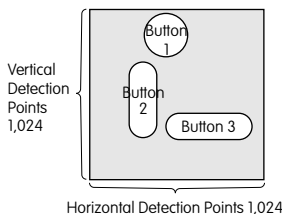

NKK Switches feature a wide variety of standard touch screens. We also have the capability and expertise to offer custom solutions that would enhance any application. We can furnish designs in both digital (matrix) and analog type touch screens; custom sizes and key numbers; attachment of touch screen to LCDs or incorporation into peripheral devices; availability of film plus film combinations and fingerprint resistant, high transmittance films. Contact our experts and let us provide a resolution for all of your touch screen requirements.

Effective Date

June 2017



<http://www.nkkswitches.com> • 1.877.2BUYNKK (228.9655)
7850 East Gelding Drive • Scottsdale, AZ 85260 • Telephone 480.991.0942 • Fax 480.998.1435