

SOURIAU

JMX SERIES



Plastic Push-Pull Coupling Mechanism

Connectors for Medical Applications



Contents

Overview

| | |
|---|----|
| Typical applications | 06 |
| Features & Benefits | 07 |
| Reliable people, reliable solutions | 08 |
| Range overview | 09 |
| Layouts | 09 |
| General technical characteristics | 10 |
| Color codings | 11 |

Connector

| | |
|---------------------------------|----|
| Overmolded cable assembly | 14 |
| 2 contacts | 16 |
| 3 contacts | 20 |
| 4 contacts | 24 |
| 5 contacts | 28 |
| 6 contacts | 32 |
| 7 contacts | 36 |
| 8 contacts | 40 |
| 10 contacts | 44 |
| 12 contacts | 48 |

Contacts

| | |
|-----------------------|----|
| Description | 54 |
| Packaging | 54 |
| Solder contacts | 55 |
| Crimp contacts | 56 |
| Tooling | 57 |

Technical Information

| | |
|--|----|
| Receptacle assembly instructions | 60 |
| Plug assembly instructions | 61 |
| Which Standard to select ? | 62 |
| UL94 + UL1977 | 63 |
| IEC 61984 & IP codes explained | 66 |
| What is NEMA rating ? | 68 |
| What is CE marking ? | 68 |
| Sterilization | 69 |
| Ethernet for the Layman | 70 |

Appendices

| | |
|-------------------------|----|
| Glossary of terms | 74 |
| Safety notice | 75 |
| Part number index | 76 |

JMX SERIES

Overview

| | |
|---|----|
| ■ Typical applications | 06 |
| ■ Features & Benefits | 07 |
| ■ Reliable People, Reliable Solutions | 08 |
| ■ Range overview | 09 |
| ■ Layouts | 09 |
| ■ General technical characteristics | 10 |
| ■ Color codings | 11 |

Typical applications



Physio & Medical Therapy



Patient Monitoring



Diagnostic Device & Imaging



Surgical & Dental Systems - Instrumentation



Laboratory Equipment



Features & Benefits

**EASY
AND
SAFE**

Reliable mating: Push-Pull Locking Mechanism

Only requires two fingers to mate/unmate securely with an audible and tactile indicator. Capable of mating over 2,000 times. Keyings and color identifications are available to avoid accidental system mating errors.

**PROTECT
YOUR
EQUIPMENT**

Waterproof: IP68 in Mated and/or Unmated Condition

JMX Series will protect your equipment from fluid ingress and liquid projection.

**STERILI-
ZATION**

Adapted for the Medical Market

Withstand to autoclave steam sterilization with pre-vacuum and gravity displacement process per IEC 60601. 200 autoclave cycles at 134°C (273°F).

**AESTHETIC
EQUIPMENT**

Designed for an Aesthetic Equipment Design

An attractive, appealing and ergonomic connector to fit with all medical equipment designs.

**MAKE
LIFE
EASIER**

UL/IEC Compliant

In accordance with UL 1977 and IEC 61984: a compliance making your equipment qualification easier.

We have thought of everything...



Rubber sealing gland



Compound



Waterproof – IP68

- A rubber gland certifying the sealing between the cable and the plug
- Compound on solder receptacles ensuring the IP68 in unmated condition



A Full Solution Offering (see page 14)

- IP68 and Overmolded Cable Assembly solutions available in standard or custom designs
- Withstands autoclave process



A Reinforced Traceability

- A date code (Year - Week) available on the plug and receptacle to ensure full traceability
- Not visible once installed



Ergonomic / Aesthetic design

- An instinctive feeling design with your fingers
- Keying and color identification to help avoid accidental mating errors
- Attractive and appealing design to fit with all medical equipment

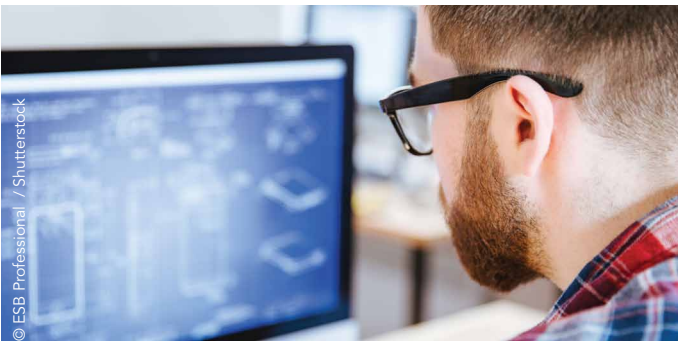

Flexibility & Availability

- Worldwide distribution network ensuring full availability and logistical support
- Customized interconnect solutions
- A dedicated team available for technical support, training and engineering collaboration
- An integrated and certified laboratory to perform tests and qualifications

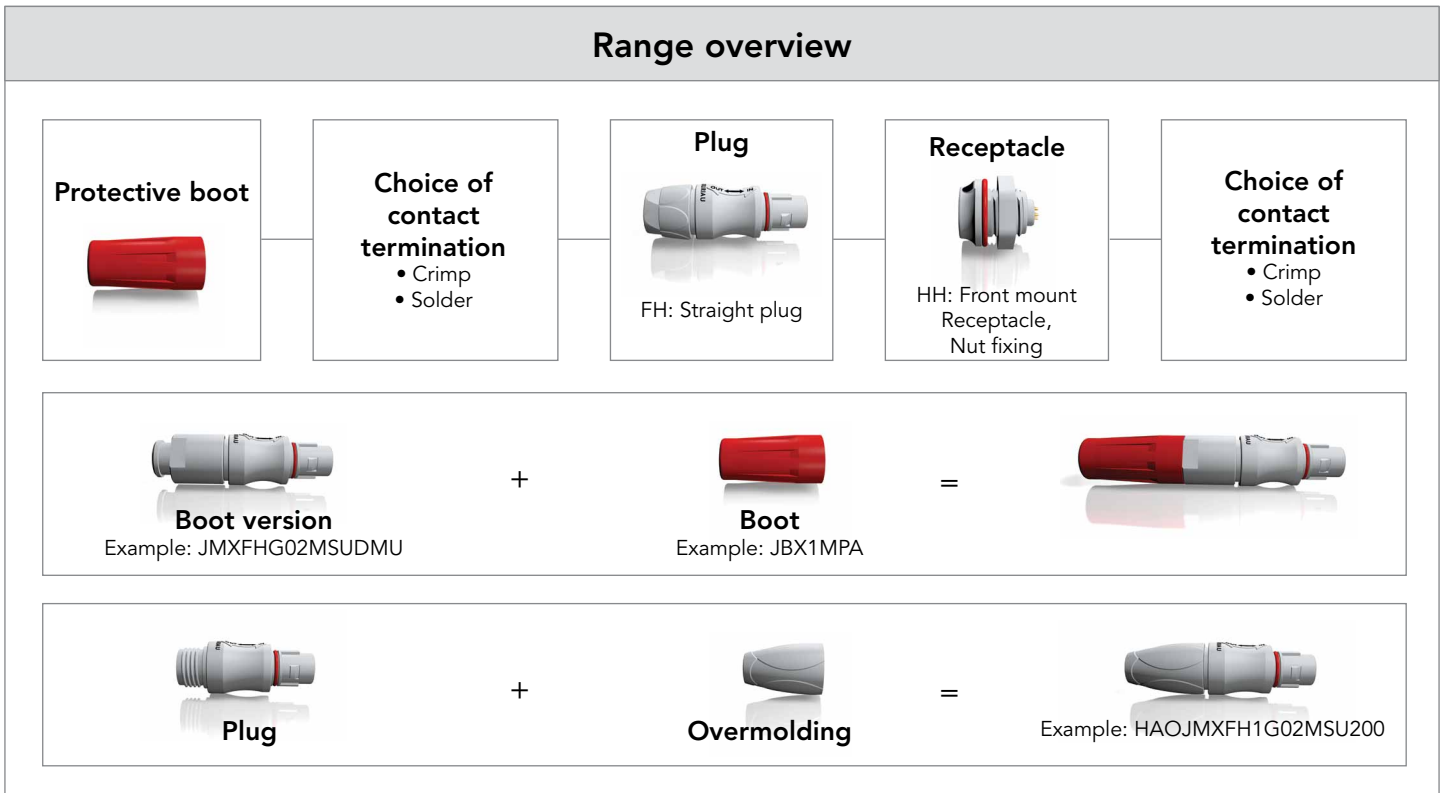

Layouts

Voltages shown below are Test Voltages measured according to the IEC 60512-2 test 4a. Test voltage corresponds to 75% of the mean dielectric withstanding voltage. Operating voltage could be calculated following the method: $\frac{\text{Test Voltage}}{3}$

Please refer to the connector section for the UL and IEC voltage values.

Contacts Ø 0.5mm / Ø 0.019"
Solder Wire: AWG 28 and smaller
Crimp Wire: Not available

Contacts Ø 0.7mm / Ø 0.027"
Solder Wire: AWG 22 and smaller
Crimp Wire: AWG 22 - 24 - 26

Contacts Ø 0.9mm / Ø 0.035"
Solder Wire: AWG 22 and smaller
Crimp Wire: AWG 20 - 22 - 24

Contacts Ø 1.3mm / Ø 0.051"
Solder Wire: AWG 20 and smaller
Crimp Wire: AWG 18 - 20 - 22



| Shell size | Contact Ø 0.5 mm | Contact Ø 0.7 mm | Contact Ø 0.9 mm | Contact Ø 1.3 mm |
|------------|---|--|--|---|
| 1 | 10 contacts 2.5A 900V AC/CD mini: 0.58 mm Page 44 | 6 contacts 6A 1,000V AC/CD mini: 0.75 mm Page 32 | 4 contacts 8A 1,100V AC/CD mini: 1.00 mm Page 24 | 2 contacts 10A 1,200V AC/CD mini: 1.20 mm Page 16 |
| | 12 contacts 2.5A 900V AC/CD mini: 0.59 mm Page 48 | 7 contacts 5A 1,000V AC/CD mini: 0.75 mm Page 36 | 5 contacts 7A 1,100V AC/CD mini: 0.80 mm Page 28 | 3 contacts 9A 1,100V AC/CD mini: 1.00 mm Page 20 |
| | | 8 contacts 5A 900V AC/CD mini: 0.54 mm Page 40 | | |

Note: AC/CD mini means minimum "Air Clearance" or "Creepage Distance".

General technical characteristics



Materials

- Shell: PEI
- Insert: PEEK
- Collet: PEI
- Cable seal: Silicon rubber
- Clip: Beryllium copper
- Contacts: Cupro-Nickel
- Contacts plating: Gold
- RoHS compliant 
- REACH compliant 
- Biocompatibility:
Shell material biocompatible to USP Class VI / ISO 10993

Environmental

- Operating temperature:
 - Receptacle: -20°C +100°C / -4°F +212°F
 - Plug: -40°C +125°C / -40°F +257°F
 - Short term (autoclaving): Resistance up to +134°C / 273.2°F
- Flammability rating:
UL94 V-0
- Steam sterilization:
Withstand to autoclave steam sterilization pre-vacuum & gravity displacement process: 200 cycles per EN13060

Sealing:

| | Mated conditions (Plug + receptacle) | Unmated conditions | | |
|-------|--------------------------------------|--------------------|---------------------------------|--------------------------------|
| | | Plug | Receptacle with solder contacts | Receptacle with crimp contacts |
| IP50 | - | ✓ | - | ✓ |
| IP68* | ✓ | - | ✓ | - |

*IP68 (1 bar during 1 week) per IEC60529

- IP68 versions are identified with the symbol "  " into the connector section.

Fluid resistance:

- Isopropyl alcohol
- Ethanol
- Sodium Hypochlorite
- Korsolex Extra
- Gigasept FF
- Incidur
- Sekusept Plus
- Sani Cloth active

Please consult us for other fluid resistance request

Mechanical

- Durability:
> 2,000 cycles per IEC 60512-5 test 9a
- Mechanical strength impact:
Dropping height 750 mm /29.527" per IEC 60512-7-2 test 7b
- Color coding:
9 color codings. Please refer to the page 11 and the connector section

Discrimination/Keying Method:

Please refer to the page 11

Acceptable cable diameter:

3.5 mm to 7.5 mm, 0.137" to 0.295"

Traction on the cable:

| In mated condition | |
|--|---|
| Traction by pulling on the cable of the plug without using the uncoupling system | |
| Average value 100N |  |
| Method IEC 60512-8 Test 15f | |

| In unmated condition | |
|--|---|
| Traction by pulling on the cable of the plug | |
| Max 150 N Depends on the cable |  |
| Method IEC 60512-9 Test 17c | |

Electrical

- Compliant to UL 1977 and IEC 61984

- Also see page 09









Color coding



In addition to the keyings, SOURIAU offers 9 colors codings on receptacles and plugs to help the user to identify the correct connector. JMX color identification remains visible in mated conditions.

Standard connector is delivered without color identification. To order a receptacle or a plug with a color, replace the final "U" by the color code from the table below.

Example: JMXHH1G02MSUDSU (no color identification) => JMXHH1G02MSUDSV (Green color identification).

| Color | Blue | Purple | Grey | Yellow | Brown | Black | Red | Green | Orange |
|--------|---|---|---|---|---|--|---|---|---|
| |  |  |  |  |  |  |  |  |  |
| Coding | A | P | G | J | M | N | R | V | O |

Discrimination / Keying methods

In applications where similar connectors are used next to each other, mismatching can cause disturbances, system failures or even danger to operating personnel.

To eliminate mismatching, JMX connectors are offered with discrimination keys to avoid interconnection system errors.

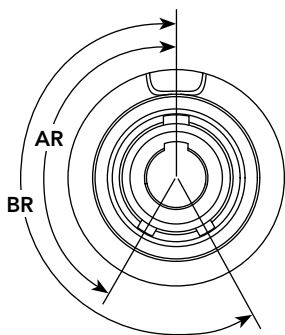

Viewed from front face receptacle

| Position | AR | BR |
|----------|------|------|
| A | 45° | 180° |
| B | 135° | 225° |
| C | 45° | 225° |
| D | 135° | 315° |
| E | 180° | 315° |
| G | 165° | 195° |

G is the standard keying. Other keyings can be ordered by replacing the G character by the needed keying.
 JMXHH1G03MSUDSU (G keying) => JMXHH1A03MSUDSU (A keying)

JMX SERIES

JMX Series

Connector

| | |
|-----------------------------------|----|
| ■ Overmolded cable assembly | 14 |
| ■ 2 contacts | |
| JMX1-02: 10A 1,200V | 16 |
| ■ 3 contacts | |
| JMX1-03: 9A 1,100V | 20 |
| ■ 4 contacts | |
| JMX1-04: 8A 1,100V | 24 |
| ■ 5 contacts | |
| JMX1-05: 7A 1,100V | 28 |
| ■ 6 contacts | |
| JMX1-06: 6A 1,000V | 32 |
| ■ 7 contacts | |
| JMX1-07: 5A 1,000V | 36 |
| ■ 8 contacts | |
| JMX1-08: 5A 900V | 40 |
| ■ 10 contacts | |
| JMX1-10: 2.5A 900V | 44 |
| ■ 12 contacts | |
| JMX1-12: 2.5A 900V | 48 |

Overmolded cable assembly

SOURIAU has provided connectors for various applications for more than 90 years and has been used in the most extreme environments. Conscious about the difficulty in finding a quick and reliable harness manufacturer, we developed our own in-house overmolded cable assembly production. It allows customers to reduce the number of suppliers and to take advantage of the “best in class” quality of the SOURIAU group. Overmolding is a process that further enhances the sealing properties and helps to minimize stress on the cable termination to the connector. In addition, the wires are encapsulated inside the molding which creates a barrier preventing liquid/moisture from entering the equipment through the connector or cable jacket if breached.



General technical characteristics

Materials

- **Connector**
 - **Shell:** PEI
 - **Insert:** PEEK
 - **Contacts:** see layout pages
- **Cable:**
 - **Insulation conductor type:** FEP
 - **600V**
 - **RoHS compliant** 

Environmental

- **Operating temperature:**
 - From -20°C to +80°C / -4 °F to 176 °F
- **Sealing:**
 - IP65 in unmated condition
 - IP68 in mated condition

Mechanical

- **Durability:**
 - > 2,000 cycles

JMX overmolded cable assembly

Overmolding description

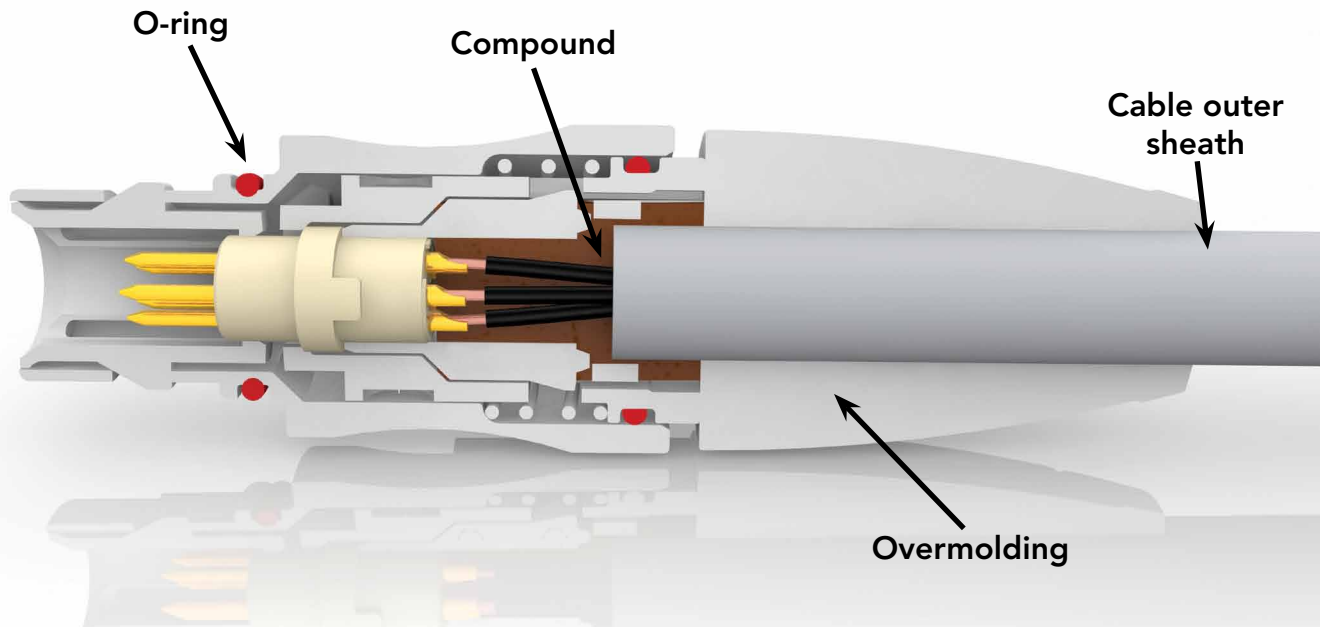

Connector

Connector with cable gland backshell

If cable jacket is breached...

GOOD

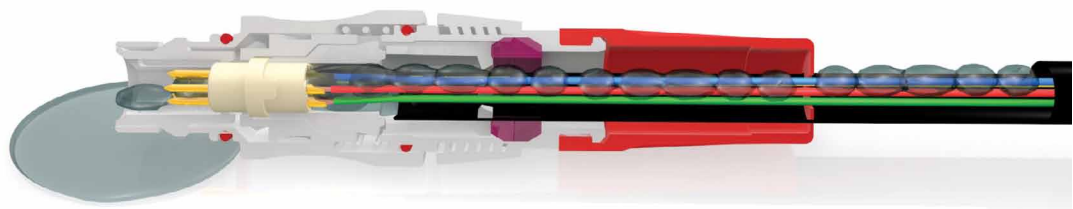

...water ingress unhampered, leading to damage.

Overmolded connector

If cable jacket is breached...

BEST

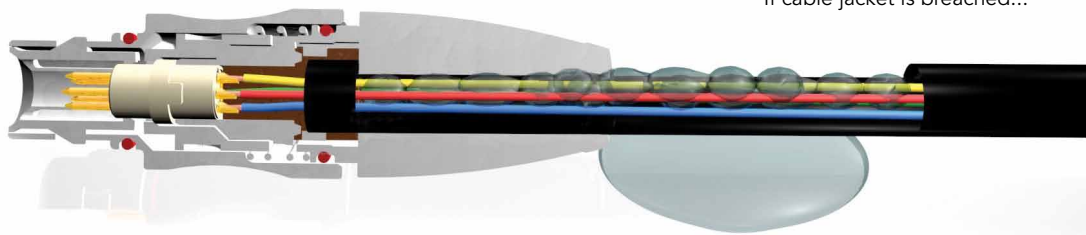

...the compound will block the liquid and prevent ingress.

JMX1-02 (2 x Ø 1.3 mm / 2 x Ø 0.051")

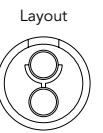

Connector part number (Products without color coding)

| Contact type | Connector type | Description | Part number | |
|--------------------------------|----------------|------------------------------|-----------------|-----------------|
| | | | Male insert | Female insert |
| Solder contacts see page 19 | Receptacle | Front mount, nut fixing (HH) | JMXHH1G02MSUDSU | JMXHH1G02FSUDSU |
| | Plug | Straight plug (FH) * | JMXFH1G02MSUDSU | JMXFH1G02FSUDSU |
| Crimp contacts see page 19 | Receptacle | Front mount, nut fixing (HH) | JMXHH1G02MCUDSU | JMXHH1G02FCUDSU |
| | Plug | Straight plug (FH) * | JMXFH1G02MCUDSU | JMXFH1G02FCUDSU |

* In order to get the back nut version for protective boot, replace the "S" by a "M". Example: JMX Straight Plug, size 1, 2 solder contacts, male insert = JMXFH1G02MSUDMU. The protective boot need to be ordered separately. See page accessories.

: Sealed in Unmated Condition

Overmolded cable assembly part number

| Layout | Description | Connector and overmold type | | Length* | | |
|--------|--------------------------------|-----------------------------|---------------|--------------------|--------------------|--------------------|
| | | Connector | Overmold type | 1m / 39.370" | 2m / 78.740" | 3m / 118.110" |
| 1-02 | Plug overmolded cable assembly | Male plug | Straight | HAOJMXFH1G02MCU100 | HAOJMXFH1G02MCU200 | HAOJMXFH1G02MCU300 |
| | | Female plug | Straight | HAOJMXFH1G02FCU100 | HAOJMXFH1G02FCU200 | HAOJMXFH1G02FCU300 |

* : Other lengths or specific design requirement please consult us

JMX1-02 (2 x Ø 1.3 mm / 2 x Ø 0.051")

Dimensions (For mated connector lengths see page 19)

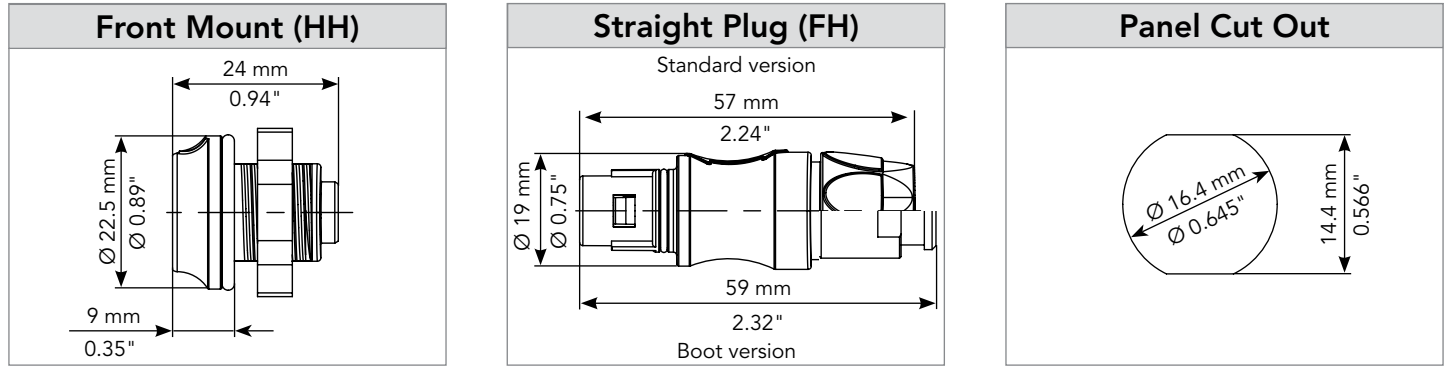

Connector color coding

| Color | Coding | Part number ⁽¹⁾ | | |
|--------|--------|----------------------------|-----------------|--------------------|
| | | Receptacle | Plug | Overmolded |
| None | U | JMXHH1G02..UDSU | JMXFH1G02..UDSU | HA0JMXFH1G02..U*** |
| Blue | A | JMXHH1G02..UDSA | JMXFH1G02..UDSA | HA0JMXFH1G02..A*** |
| Purple | P | JMXHH1G02..UDSP | JMXFH1G02..UDSP | HA0JMXFH1G02..P*** |
| Grey | G | JMXHH1G02..UDSG | JMXFH1G02..UDSG | HA0JMXFH1G02..G*** |
| Yellow | J | JMXHH1G02..UDSJ | JMXFH1G02..UDSJ | HA0JMXFH1G02..J*** |
| Brown | M | JMXHH1G02..UDSM | JMXFH1G02..UDSM | HA0JMXFH1G02..M*** |
| Black | N | JMXHH1G02..UDSN | JMXFH1G02..UDSN | HA0JMXFH1G02..N*** |
| Red | R | JMXHH1G02..UDSR | JMXFH1G02..UDSR | HA0JMXFH1G02..R*** |
| Green | V | JMXHH1G02..UDSV | JMXFH1G02..UDSV | HA0JMXFH1G02..V*** |
| Orange | O | JMXHH1G02..UDSO | JMXFH1G02..UDSO | HA0JMXFH1G02..O*** |

1: Standard HH receptacle is delivered without color identification. To order a receptacle or a plug with a color, replace the final "U" by the color code from the table above.
 ".": first "." = gender, second "." = termination.
 "***": harness length = 100 (1m), 200 (2m) or 300 (3m).
 Example : JMXHH1G02MSUDSU (no color identification) => JMXHH1G02MSUDSV (Green color identification).

JMX1-02 (2 x Ø 1.3 mm / 2 x Ø 0.051")

Accessories

Receptacle dust cap



Part number
JMXBR1

Plug dust cap



Part number
JMXBF1

Plug protective boot

Available only for FH, with back nut protective boot 



| Part number | Color |
|----------------|--------|
| JBX1MPA | Blue |
| JBX1MPB | White |
| JBX1MPG | Grey |
| JBX1MPJ | Yellow |
| JBX1MPM | Brown |
| JBX1MPN | Black |
| JBX1MPR | Red |
| JBX1MPV | Green |
| JBX1MPO | Orange |

The overall length is 25 mm/0.98" longer with the protective boot.
Note: The protective boot is not a sealing element.

Tooling for crimp contacts

Crimp tooling



Part number
M22520/7-01

Locator



| Part number | |
|--------------------|--------------------|
| Male | Female |
| JBX10UTLP13 | JBX10UTLS13 |

Extraction tool

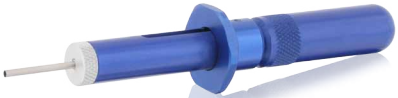

Part number
JBX0UTDC13



JMX1-02 (2 x Ø 1.3 mm / 2 x Ø 0.051")

Contacts

| Ø 1.3 mm / Ø 0.051 " | Contact type | Plating | Contact locking type | AWG |
|----------------------|--------------|-------------------------------|----------------------|----------------|
| Solder | Machined | 0.5 µm gold over 3 to 5 µm Ni | Removable on plugs | 20 and smaller |
| Crimp | Machined | 0.5 µm gold over 3 to 5 µm Ni | Removable | 18 - 20 - 22 |

For more information see pages 55 to 56

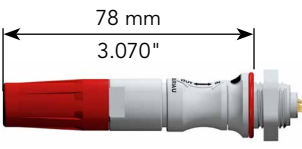
Mated connector length

| FH Plug + Receptacle | | |
|--|---|--|
|  <p>51 mm 2.007"</p> <p>with HH</p> |  <p>78 mm 3.070"</p> <p>with Boot and HH</p> |  <p>61 mm 2.401"</p> <p>with Overmolding and HH</p> |

Connector

| IEC / UL characteristics | |
|--|--|
| <p>IEC 10A 840 Vdc 1.5 kV 2</p> | <p>UL 10A 300V UL94 V-0</p> |

JMX1-03 (3 x Ø 1.3 mm / 3 x Ø 0.051")

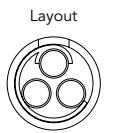

Connector part number (Products without color coding)

| Contact type | Connector type | Description | Part number | |
|--------------------------------|----------------|--------------------------------|-----------------|-----------------|
| | | | Male insert | Female insert |
| Solder contacts see page 23 | Receptacle | Front mount, nut fixing (HH) ☁ | JMXHH1G03MSUDSU | JMXHH1G03FSUDSU |
| | Plug | Straight plug (FH) * | JMXFH1G03MSUDSU | JMXFH1G03FSUDSU |
| Crimp contacts see page 23 | Receptacle | Front mount, nut fixing (HH) | JMXHH1G03MCUDSU | JMXHH1G03FCUDSU |
| | Plug | Straight plug (FH) * | JMXFH1G03MCUDSU | JMXFH1G03FCUDSU |

* In order to get the back nut version for protective boot, replace the "S" by a "M". Example: JMX Straight Plug, size 1, 3 solder contacts, male insert = JMXFH1G03MSUDMU. The protective boot need to be ordered separately. See page accessories.

☁ : Sealed in Unmated Condition

Overmolded cable assembly part number

| Layout | Description | Connector and overmold type | | Length* | | |
|--------|--------------------------------|-----------------------------|---------------|--------------------|--------------------|--------------------|
| | | Connector | Overmold type | 1m / 39.370" | 2m / 78.740" | 3m / 118.110" |
| 1-03 | Plug overmolded cable assembly | Male plug | Straight | HAOJMXFH1G03MCU100 | HAOJMXFH1G03MCU200 | HAOJMXFH1G03MCU300 |
| | | Female plug | Straight | HAOJMXFH1G03FCU100 | HAOJMXFH1G03FCU200 | HAOJMXFH1G03FCU300 |

* : Other lengths or specific design requirement please consult us

JMX1-03 (3 x Ø 1.3 mm / 3 x Ø 0.051")

Dimensions (For mated connector lengths see page 23)

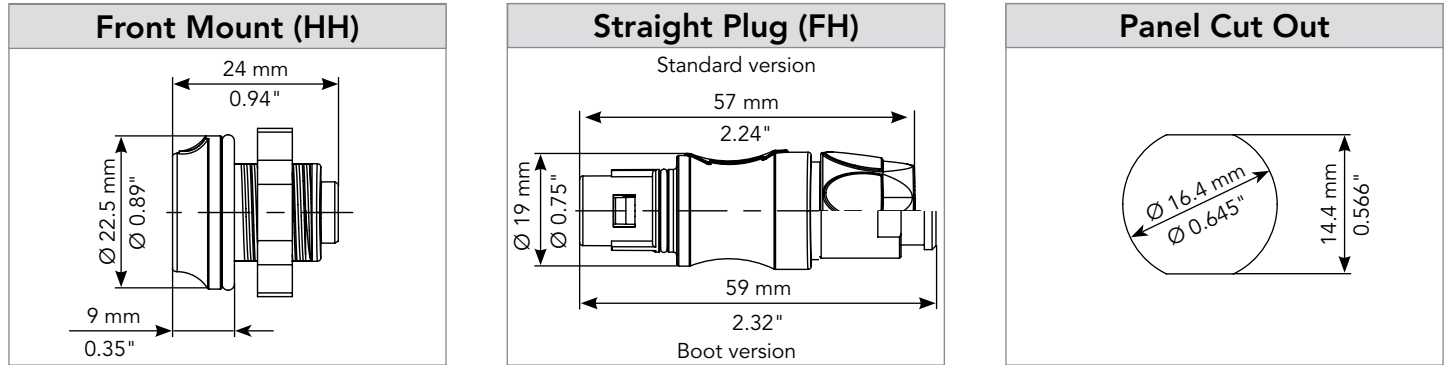

Connector color coding

| Color | Coding | Part number ⁽¹⁾ | | |
|--------|--------|----------------------------|-------------------|----------------------|
| | | Receptacle | Plug | Overmolded |
| None | U | JMXHH1G03 . .UDSU | JMXFH1G03 . .UDSU | HA0JMXFH1G03 . .U*** |
| Blue | A | JMXHH1G03 . .UDSA | JMXFH1G03 . .UDSA | HA0JMXFH1G03 . .A*** |
| Purple | P | JMXHH1G03 . .UDSP | JMXFH1G03 . .UDSP | HA0JMXFH1G03 . .P*** |
| Grey | G | JMXHH1G03 . .UDSG | JMXFH1G03 . .UDSG | HA0JMXFH1G03 . .G*** |
| Yellow | J | JMXHH1G03 . .UDSJ | JMXFH1G03 . .UDSJ | HA0JMXFH1G03 . .J*** |
| Brown | M | JMXHH1G03 . .UDSM | JMXFH1G03 . .UDSM | HA0JMXFH1G03 . .M*** |
| Black | N | JMXHH1G03 . .UDSN | JMXFH1G03 . .UDSN | HA0JMXFH1G03 . .N*** |
| Red | R | JMXHH1G03 . .UDSR | JMXFH1G03 . .UDSR | HA0JMXFH1G03 . .R*** |
| Green | V | JMXHH1G03 . .UDSV | JMXFH1G03 . .UDSV | HA0JMXFH1G03 . .V*** |
| Orange | O | JMXHH1G03 . .UDSO | JMXFH1G03 . .UDSO | HA0JMXFH1G03 . .O*** |

1: Standard HH receptacle is delivered without color identification. To order a receptacle or a plug with a color, replace the final "U" by the color code from the table above.
 ". .": first "." = gender, second "." = termination.
 "***": harness length = 100 (1m), 200 (2m) or 300 (3m).
 Example : JMXHH1G03MSUDSU (no color identification) => JMXHH1G03MSUDSV (Green color identification).

JMX1-03 (3 x Ø 1.3 mm / 3 x Ø 0.051")

Accessories

Receptacle dust cap



| |
|-------------|
| Part number |
| JMXBR1 |

Plug dust cap



| |
|-------------|
| Part number |
| JMXBF1 |

Plug protective boot

Available only for FH, with back nut protective boot 



| Part number | Color |
|-------------|--------|
| JBX1MPA | Blue |
| JBX1MPB | White |
| JBX1MPG | Grey |
| JBX1MPJ | Yellow |
| JBX1MPM | Brown |
| JBX1MPN | Black |
| JBX1MPR | Red |
| JBX1MPV | Green |
| JBX1MPO | Orange |

The overall length is 25 mm/0.98" longer with the protective boot.
 Note: The protective boot is not a sealing element.

Tooling for crimp contacts

Crimp tooling



| |
|-------------|
| Part number |
| M22520/7-01 |

Locator



| Part number | |
|-------------|-------------|
| Male | Female |
| JBX10UTLP13 | JBX10UTLS13 |

Extraction tool

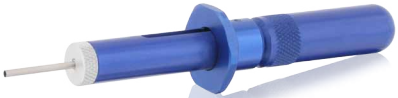

| |
|-------------|
| Part number |
| JBX0UTDC13 |



JMX1-03 (3 x Ø 1.3 mm / 3 x Ø 0.051")

Contacts

| Ø 1.3 mm / Ø 0.051 " | Contact type | Plating | Contact locking type | AWG |
|----------------------|--------------|-------------------------------|----------------------|----------------|
| Solder | Machined | 0.5 µm gold over 3 to 5 µm Ni | Removable on plugs | 20 and smaller |
| Crimp | Machined | 0.5 µm gold over 3 to 5 µm Ni | Removable | 18 - 20 - 22 |

For more information see pages 55 to 56

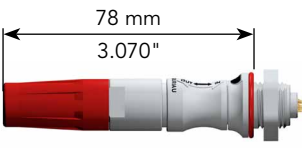
Mated connector length

| FH Plug + Receptacle | | |
|--|---|--|
|  <p>51 mm 2.007"</p> <p>with HH</p> |  <p>78 mm 3.070"</p> <p>with Boot and HH</p> |  <p>61 mm 2.401"</p> <p>with Overmolding and HH</p> |

Connector

| IEC / UL characteristics | |
|--|--|
| <p>IEC 9A 840 Vdc 1.5 kV 2</p> | <p>UL 9A 230V UL94 V-0</p> |

JMX1-04 (4 x Ø 0.9 mm / 4 x Ø 0.035")

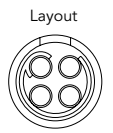

Connector part number (Products without color coding)

| Contact type | Connector type | Description | Part number | |
|--------------------------------|----------------|--------------------------------|-----------------|-----------------|
| | | | Male insert | Female insert |
| Solder contacts see page 27 | Receptacle | Front mount, nut fixing (HH) ☁ | JMXHH1G04MSUDSU | JMXHH1G04FSUDSU |
| | Plug | Straight plug (FH) * | JMXFH1G04MSUDSU | JMXFH1G04FSUDSU |
| Crimp contacts see page 27 | Receptacle | Front mount, nut fixing (HH) | JMXHH1G04MCUDSU | JMXHH1G04FCUDSU |
| | Plug | Straight plug (FH) * | JMXFH1G04MCUDSU | JMXFH1G04FCUDSU |

* In order to get the back nut version for protective boot, replace the "S" by a "M". Example: JMX Straight Plug, size 1, 4 solder contacts, male insert = JMXFH1G04MSUDMU. The protective boot need to be ordered separately. See page accessories.

☁ : Sealed in Unmated Condition

Overmolded cable assembly part number

| Layout | Description | Connector and overmold type | | Length* | | |
|--------|--------------------------------|-----------------------------|---------------|--------------------|--------------------|--------------------|
| | | Connector | Overmold type | 1m / 39.370" | 2m / 78.740" | 3m / 118.110" |
| 1-04 | Plug overmolded cable assembly | Male plug | Straight | HAOJMXFH1G04MCU100 | HAOJMXFH1G04MCU200 | HAOJMXFH1G04MCU300 |
| | | Female plug | Straight | HAOJMXFH1G04FCU100 | HAOJMXFH1G04FCU200 | HAOJMXFH1G04FCU300 |

* : Other lengths or specific design requirement please consult us

JMX1-04 (4 x Ø 0.9 mm / 4 x Ø 0.035")

Dimensions (For mated connector lengths see page 27)

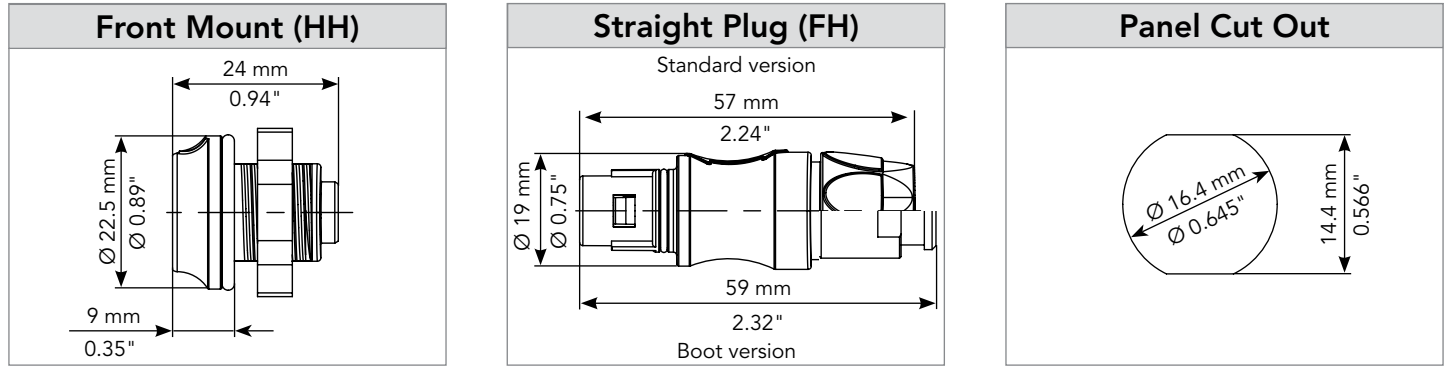

Connector color coding

| Color | Coding | Part number ⁽¹⁾ | | |
|--------|--------|----------------------------|-------------------|----------------------|
| | | Receptacle | Plug | Overmolded |
| None | U | JMXHH1G04 . .UDSU | JMXFH1G04 . .UDSU | HA0JMXFH1G04 . .U*** |
| Blue | A | JMXHH1G04 . .UDSA | JMXFH1G04 . .UDSA | HA0JMXFH1G04 . .A*** |
| Purple | P | JMXHH1G04 . .UDSP | JMXFH1G04 . .UDSP | HA0JMXFH1G04 . .P*** |
| Grey | G | JMXHH1G04 . .UDSG | JMXFH1G04 . .UDSG | HA0JMXFH1G04 . .G*** |
| Yellow | J | JMXHH1G04 . .UDSJ | JMXFH1G04 . .UDSJ | HA0JMXFH1G04 . .J*** |
| Brown | M | JMXHH1G04 . .UDSM | JMXFH1G04 . .UDSM | HA0JMXFH1G04 . .M*** |
| Black | N | JMXHH1G04 . .UDSN | JMXFH1G04 . .UDSN | HA0JMXFH1G04 . .N*** |
| Red | R | JMXHH1G04 . .UDSR | JMXFH1G04 . .UDSR | HA0JMXFH1G04 . .R*** |
| Green | V | JMXHH1G04 . .UDSV | JMXFH1G04 . .UDSV | HA0JMXFH1G04 . .V*** |
| Orange | O | JMXHH1G04 . .UDSO | JMXFH1G04 . .UDSO | HA0JMXFH1G04 . .O*** |

1: Standard HH receptacle is delivered without color identification. To order a receptacle or a plug with a color, replace the final "U" by the color code from the table above.
 ". .": first "." = gender, second "." = termination.
 "***": harness length = 100 (1m), 200 (2m) or 300 (3m).
 Example : JMXHH1G04MSUDSU (no color identification) => JMXHH1G04MSUDSV (Green color identification).

JMX1-04 (4 x Ø 0.9 mm / 4 x Ø 0.035")

Accessories

Receptacle dust cap



| |
|-------------|
| Part number |
| JMXBR1 |

Plug dust cap



| |
|-------------|
| Part number |
| JMXBF1 |

Plug protective boot

Available only for FH, with back nut protective boot 



| Part number | Color |
|-------------|--------|
| JBX1MPA | Blue |
| JBX1MPB | White |
| JBX1MPG | Grey |
| JBX1MPJ | Yellow |
| JBX1MPM | Brown |
| JBX1MPN | Black |
| JBX1MPR | Red |
| JBX1MPV | Green |
| JBX1MPO | Orange |

The overall length is 25 mm/0.98" longer with the protective boot.
 Note: The protective boot is not a sealing element.

Tooling for crimp contacts

Crimp tooling



| |
|-------------|
| Part number |
| M22520/7-01 |

Locator



| Part number | |
|-------------|-------------|
| Male | Female |
| JBX10UTLP09 | JBX10UTLS09 |

Extraction tool



| |
|-------------|
| Part number |
| JBX0UTDC09 |



JMX1-04 (4 x Ø 0.9 mm / 4 x Ø 0.035")

Contacts

| Ø 0.9 mm / Ø 0.035" | Contact type | Plating | Contact locking type | AWG |
|---------------------|--------------|-------------------------------|----------------------|----------------|
| Solder | Machined | 0.5 µm gold over 3 to 5 µm Ni | Removable on plugs | 22 and smaller |
| Crimp | Machined | 0.5 µm gold over 3 to 5 µm Ni | Removable | 20 - 22 - 24 |

For more information see pages 55 to 56

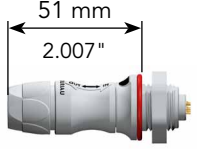
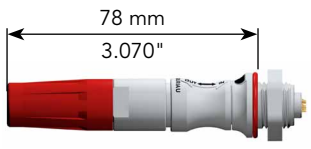
Mated connector length

| FH Plug + Receptacle | | |
|--|---|--|
|  <p>51 mm 2.007"</p> <p>with HH</p> |  <p>78 mm 3.070"</p> <p>with Boot and HH</p> |  <p>61 mm 2.401"</p> <p>with Overmolding and HH</p> |

IEC / UL characteristics

IEC
8A 840 Vdc 1.5 kV 2

UL
8A 230V UL94 V-0

JMX1-05 (5 x Ø 0.9 mm / 5 x Ø 0.035")

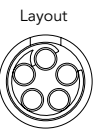

Connector part number (Products without color coding)

| Contact type | Connector type | Description | Part number | |
|--------------------------------|----------------|------------------------------|-----------------|-----------------|
| | | | Male insert | Female insert |
| Solder contacts see page 31 | Receptacle | Front mount, nut fixing (HH) | JMXHH1G05MSUDSU | JMXHH1G05FSUDSU |
| | Plug | Straight plug (FH) * | JMXFH1G05MSUDSU | JMXFH1G05FSUDSU |
| Crimp contacts see page 31 | Receptacle | Front mount, nut fixing (HH) | JMXHH1G05MCUDSU | JMXHH1G05FCUDSU |
| | Plug | Straight plug (FH) * | JMXFH1G05MCUDSU | JMXFH1G05FCUDSU |

* In order to get the back nut version for protective boot, replace the "S" by a "M". Example: JMX Straight Plug, size 1, 5 solder contacts, male insert = JMXFH1G05MSUDMU. The protective boot need to be ordered separately. See page accessories.

: Sealed in Unmated Condition

Overmolded cable assembly part number

| Layout | Description | Connector and overmold type | | Length* | | |
|--------|--------------------------------|-----------------------------|---------------|--------------------|--------------------|--------------------|
| | | Connector | Overmold type | 1m / 39.370" | 2m / 78.740" | 3m / 118.110" |
| 1-05 | Plug overmolded cable assembly | Male plug | Straight | HAOJMXFH1G05MCU100 | HAOJMXFH1G05MCU200 | HAOJMXFH1G05MCU300 |
| | | Female plug | Straight | HAOJMXFH1G05FCU100 | HAOJMXFH1G05FCU200 | HAOJMXFH1G05FCU300 |

* : Other lengths or specific design requirement please consult us

JMX1-05 (5 x Ø 0.9 mm / 5 x Ø 0.035")

Dimensions (For mated connector lengths see page 31)

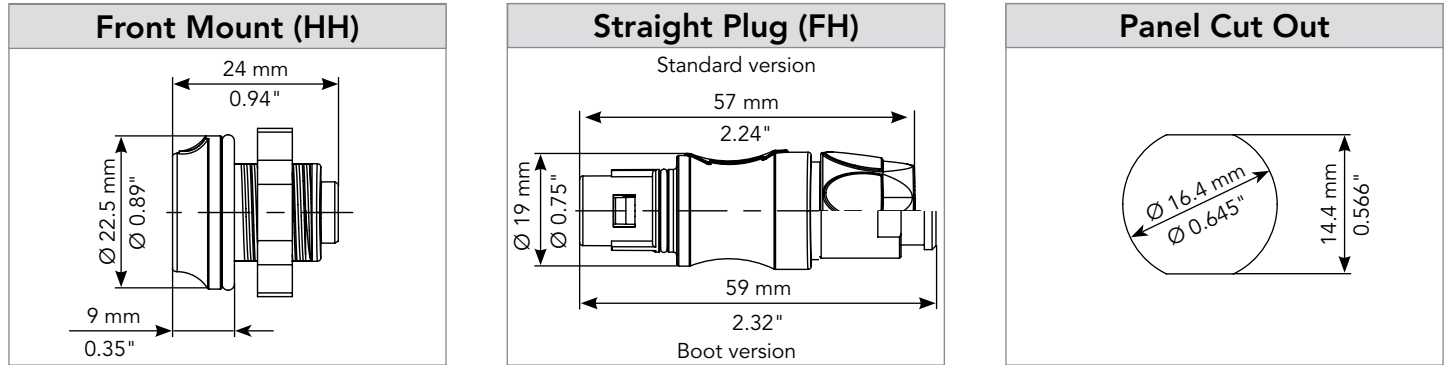

Connector color coding

| Color | Coding | Part number ⁽¹⁾ | | |
|--------|--------|----------------------------|-------------------|----------------------|
| | | Receptacle | Plug | Overmolded |
| None | U | JMXHH1G05 . .UDSU | JMXFH1G05 . .UDSU | HA0JMXFH1G05 . .U*** |
| Blue | A | JMXHH1G05 . .UDSA | JMXFH1G05 . .UDSA | HA0JMXFH1G05 . .A*** |
| Purple | P | JMXHH1G05 . .UDSP | JMXFH1G05 . .UDSP | HA0JMXFH1G05 . .P*** |
| Grey | G | JMXHH1G05 . .UDSG | JMXFH1G05 . .UDSG | HA0JMXFH1G05 . .G*** |
| Yellow | J | JMXHH1G05 . .UDSJ | JMXFH1G05 . .UDSJ | HA0JMXFH1G05 . .J*** |
| Brown | M | JMXHH1G05 . .UDSM | JMXFH1G05 . .UDSM | HA0JMXFH1G05 . .M*** |
| Black | N | JMXHH1G05 . .UDSN | JMXFH1G05 . .UDSN | HA0JMXFH1G05 . .N*** |
| Red | R | JMXHH1G05 . .UDSR | JMXFH1G05 . .UDSR | HA0JMXFH1G05 . .R*** |
| Green | V | JMXHH1G05 . .UDSV | JMXFH1G05 . .UDSV | HA0JMXFH1G05 . .V*** |
| Orange | O | JMXHH1G05 . .UDSO | JMXFH1G05 . .UDSO | HA0JMXFH1G05 . .O*** |

1: Standard HH receptacle is delivered without color identification. To order a receptacle or a plug with a color, replace the final "U" by the color code from the table above.
 ". .": first "." = gender, second "." = termination.
 "***": harness length = 100 (1m), 200 (2m) or 300 (3m).
 Example : JMXHH1G05MSUDSU (no color identification) => JMXHH1G05MSUDSV (Green color identification).

JMX1-05 (5 x Ø 0.9 mm / 5 x Ø 0.035")

Accessories

Receptacle dust cap



| |
|---------------|
| Part number |
| JMXBR1 |

Plug dust cap



| |
|---------------|
| Part number |
| JMXBF1 |

Plug protective boot

Available only for FH, with back nut protective boot 



| Part number | Color |
|----------------|--------|
| JBX1MPA | Blue |
| JBX1MPB | White |
| JBX1MPG | Grey |
| JBX1MPJ | Yellow |
| JBX1MPM | Brown |
| JBX1MPN | Black |
| JBX1MPR | Red |
| JBX1MPV | Green |
| JBX1MPO | Orange |

The overall length is 25 mm/0.98" longer with the protective boot.
 Note: The protective boot is not a sealing element.

Tooling for crimp contacts

Crimp tooling



| |
|--------------------|
| Part number |
| M22520/7-01 |

Locator



| Part number | |
|--------------------|--------------------|
| Male | Female |
| JBX10UTLP09 | JBX10UTLS09 |

Extraction tool



| |
|-------------------|
| Part number |
| JBX0UTDC09 |



JMX1-05 (5 x Ø 0.9 mm / 5 x Ø 0.035")

Contacts

| Ø 0.7 mm / Ø 0.027" | Contact type | Plating | Contact locking type | AWG |
|---------------------|--------------|-------------------------------|----------------------|----------------|
| Solder | Machined | 0.5 µm gold over 3 to 5 µm Ni | Removable on plugs | 22 and smaller |
| Crimp | Machined | 0.5 µm gold over 3 to 5 µm Ni | Removable | 20 - 22 - 24 |

For more information see pages 55 to 56

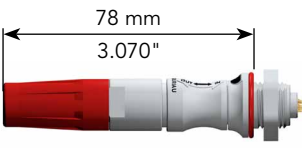
Mated connector length

| FH Plug + Receptacle | | |
|--|---|--|
|  <p>51 mm 2.007"</p> <p>with HH</p> |  <p>78 mm 3.070"</p> <p>with Boot and HH</p> |  <p>61 mm 2.401"</p> <p>with Overmolding and HH</p> |

| IEC / UL characteristics | |
|---|---------------------------------------|
| <p>IEC 7A 840 Vdc 1.5 kV 2</p> | <p>UL 7A 230V UL94 V-0</p> |

JMX1-06 (6 x Ø 0.7 mm / 6 x Ø 0.027")

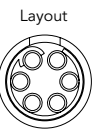

Connector part number (Products without color coding)

| Contact type | Connector type | Description | Part number | |
|--------------------------------|----------------|--------------------------------|-----------------|-----------------|
| | | | Male insert | Female insert |
| Solder contacts see page 35 | Receptacle | Front mount, nut fixing (HH) ☁ | JMXHH1G06MSUDSU | JMXHH1G06FSUDSU |
| | Plug | Straight plug (FH) * | JMXFH1G06MSUDSU | JMXFH1G06FSUDSU |
| Crimp contacts see page 35 | Receptacle | Front mount, nut fixing (HH) | JMXHH1G06MCUDSU | JMXHH1G06FCUDSU |
| | Plug | Straight plug (FH) * | JMXFH1G06MCUDSU | JMXFH1G06FCUDSU |

* In order to get the back nut version for protective boot, replace the "S" by a "M". Example: JMX Straight Plug, size 1, 6 solder contacts, male insert = JMXFH1G06MSUDMU. The protective boot need to be ordered separately. See page accessories.

☁ : Sealed in Unmated Condition

Overmolded cable assembly part number

| Layout | Description | Connector and overmold type | | Length* | | |
|--------|--------------------------------|-----------------------------|---------------|--------------------|--------------------|--------------------|
| | | Connector | Overmold type | 1m / 39.370" | 2m / 78.740" | 3m / 118.110" |
| 1-06 | Plug overmolded cable assembly | Male plug | Straight | HAOJMXFH1G06MCU100 | HAOJMXFH1G06MCU200 | HAOJMXFH1G06MCU300 |
| | | Female plug | Straight | HAOJMXFH1G06FCU100 | HAOJMXFH1G06FCU200 | HAOJMXFH1G06FCU300 |

* : Other lengths or specific design requirement please consult us

JMX1-06 (6 x Ø 0.7 mm / 6 x Ø 0.027")

Dimensions (For mated connector lengths see page 35)

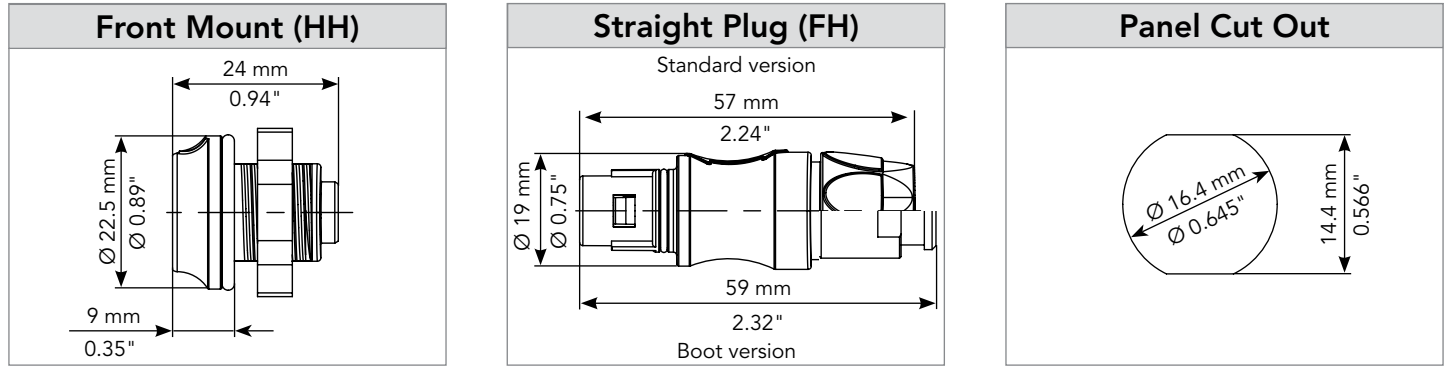

Connector color coding

| Color | Coding | Part number ⁽¹⁾ | | |
|--------|--------|----------------------------|-------------------|----------------------|
| | | Receptacle | Plug | Overmolded |
| None | U | JMXHH1G06 . .UDSU | JMXFH1G06 . .UDSU | HA0JMXFH1G06 . .U*** |
| Blue | A | JMXHH1G06 . .UDSA | JMXFH1G06 . .UDSA | HA0JMXFH1G06 . .A*** |
| Purple | P | JMXHH1G06 . .UDSP | JMXFH1G06 . .UDSP | HA0JMXFH1G06 . .P*** |
| Grey | G | JMXHH1G06 . .UDSG | JMXFH1G06 . .UDSG | HA0JMXFH1G06 . .G*** |
| Yellow | J | JMXHH1G06 . .UDSJ | JMXFH1G06 . .UDSJ | HA0JMXFH1G06 . .J*** |
| Brown | M | JMXHH1G06 . .UDSM | JMXFH1G06 . .UDSM | HA0JMXFH1G06 . .M*** |
| Black | N | JMXHH1G06 . .UDSN | JMXFH1G06 . .UDSN | HA0JMXFH1G06 . .N*** |
| Red | R | JMXHH1G06 . .UDSR | JMXFH1G06 . .UDSR | HA0JMXFH1G06 . .R*** |
| Green | V | JMXHH1G06 . .UDSV | JMXFH1G06 . .UDSV | HA0JMXFH1G06 . .V*** |
| Orange | O | JMXHH1G06 . .UDSO | JMXFH1G06 . .UDSO | HA0JMXFH1G06 . .O*** |

1: Standard HH receptacle is delivered without color identification. To order a receptacle or a plug with a color, replace the final "U" by the color code from the table above.
 ". .": first "." = gender, second "." = termination.
 "***": harness length = 100 (1m), 200 (2m) or 300 (3m).
 Example : JMXHH1G06MSUDSU (no color identification) => JMXHH1G06MSUDSV (Green color identification).

JMX1-06 (6 x Ø 0.7 mm / 6 x Ø 0.027")

Accessories

Receptacle dust cap



Part number
JMXBR1

Plug dust cap



Part number
JMXBF1

Plug protective boot

Available only for FH, with back nut protective boot 



| Part number | Color |
|----------------|--------|
| JBX1MPA | Blue |
| JBX1MPB | White |
| JBX1MPG | Grey |
| JBX1MPJ | Yellow |
| JBX1MPM | Brown |
| JBX1MPN | Black |
| JBX1MPR | Red |
| JBX1MPV | Green |
| JBX1MPO | Orange |

The overall length is 25 mm/0.98" longer with the protective boot.
Note: The protective boot is not a sealing element.

Tooling for crimp contacts

Crimp tooling



Part number
M22520/7-01

Locator



| Part number | |
|--------------------|--------------------|
| Male | Female |
| JBX10UTLP07 | JBX10UTLS07 |

Extraction tool



Part number
JBX0UTDC07



JMX1-06 (6 x Ø 0.7 mm / 6 x Ø 0.027")

Contacts

| Ø 0.7 mm / Ø 0.027" | Contact type | Plating | Contact locking type | AWG |
|---------------------|--------------|-------------------------------|----------------------|----------------|
| Solder | Machined | 0.5 µm gold over 3 to 5 µm Ni | Fixed | 22 and smaller |
| Crimp | Machined | 0.5 µm gold over 3 to 5 µm Ni | Removable | 22 - 24 - 26 |

For more information see pages 55 to 56

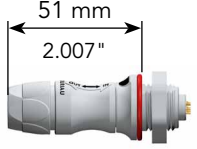
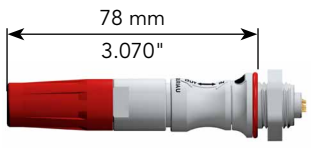
Mated connector length

| FH Plug + Receptacle | | |
|--|---|--|
|  <p>51 mm 2.007"</p> <p>with HH</p> |  <p>78 mm 3.070"</p> <p>with Boot and HH</p> |  <p>61 mm 2.401"</p> <p>with Overmolding and HH</p> |

| IEC / UL characteristics | |
|---|---------------------------------------|
| <p>IEC 6A 840 Vdc 1.5 kV 2</p> | <p>UL 6A 160V UL94 V-0</p> |

JMX1-07 (7 x Ø 0.7 mm / 7 x Ø 0.027")

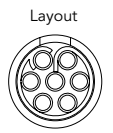

Connector part number (Products without color coding)

| Contact type | Connector type | Description | Part number | |
|--------------------------------|----------------|--------------------------------|------------------------|------------------------|
| | | | Male insert | Female insert |
| Solder contacts see page 39 | Receptacle | Front mount, nut fixing (HH) ☁ | JMXHH1G07MSUDSU | JMXHH1G07FSUDSU |
| | Plug | Straight plug (FH) * | JMXFH1G07MSUDSU | JMXFH1G07FSUDSU |
| Crimp contacts see page 39 | Receptacle | Front mount, nut fixing (HH) | JMXHH1G07MCUDSU | JMXHH1G07FCUDSU |
| | Plug | Straight plug (FH) * | JMXFH1G07MCUDSU | JMXFH1G07FCUDSU |

* In order to get the back nut version for protective boot, replace the "S" by a "M". Example: JMX Straight Plug, size 1, 7 solder contacts, male insert = JMXFH1G07MSUDMU. The protective boot need to be ordered separately. See page accessories.

☁ : Sealed in Unmated Condition

Overmolded cable assembly part number

| Layout | Description | Connector and overmold type | | Length* | | |
|--------|--------------------------------|-----------------------------|---------------|---------------------------|---------------------------|---------------------------|
| | | Connector | Overmold type | 1m / 39.370" | 2m / 78.740" | 3m / 118.110" |
| 1-07 | Plug overmolded cable assembly | Male plug | Straight | HAOJMXFH1G07MCU100 | HAOJMXFH1G07MCU200 | HAOJMXFH1G07MCU300 |
| | | Female plug | Straight | HAOJMXFH1G07FCU100 | HAOJMXFH1G07FCU200 | HAOJMXFH1G07FCU300 |

* : Other lengths or specific design requirement please consult us

JMX1-07 (7 x Ø 0.7 mm / 7 x Ø 0.027")

Dimensions (For mated connector lengths see page 39)

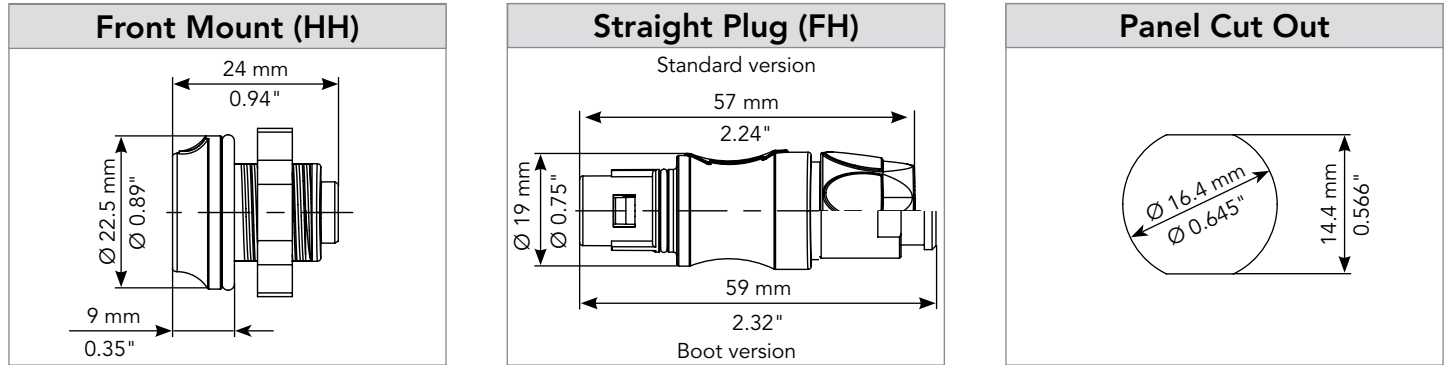

Connector color coding

| Color | Coding | Part number ⁽¹⁾ | | |
|--------|--------|----------------------------|-----------------|--------------------|
| | | Receptacle | Plug | Overmolded |
| None | U | JMXHH1G07..UDSU | JMXFH1G07..UDSU | HA0JMXFH1G07..U*** |
| Blue | A | JMXHH1G07..UDSA | JMXFH1G07..UDSA | HA0JMXFH1G07..A*** |
| Purple | P | JMXHH1G07..UDSP | JMXFH1G07..UDSP | HA0JMXFH1G07..P*** |
| Grey | G | JMXHH1G07..UDSG | JMXFH1G07..UDSG | HA0JMXFH1G07..G*** |
| Yellow | J | JMXHH1G07..UDSJ | JMXFH1G07..UDSJ | HA0JMXFH1G07..J*** |
| Brown | M | JMXHH1G07..UDSM | JMXFH1G07..UDSM | HA0JMXFH1G07..M*** |
| Black | N | JMXHH1G07..UDSN | JMXFH1G07..UDSN | HA0JMXFH1G07..N*** |
| Red | R | JMXHH1G07..UDSR | JMXFH1G07..UDSR | HA0JMXFH1G07..R*** |
| Green | V | JMXHH1G07..UDSV | JMXFH1G07..UDSV | HA0JMXFH1G07..V*** |
| Orange | O | JMXHH1G07..UDSO | JMXFH1G07..UDSO | HA0JMXFH1G07..O*** |

1: Standard HH receptacle is delivered without color identification. To order a receptacle or a plug with a color, replace the final "U" by the color code from the table above.
 ". . .": first "." = gender, second "." = termination.
 "***": harness length = 100 (1m), 200 (2m) or 300 (3m).
 Example : JMXHH1G07MSUDSU (no color identification) => JMXHH1G07MSUDSV (Green color identification).

JMX1-07 (7 x Ø 0.7 mm / 7 x Ø 0.027")

Accessories

Receptacle dust cap



Part number
JMXBR1

Plug dust cap



Part number
JMXBF1

Plug protective boot

Available only for FH, with back nut protective boot 



| Part number | Color |
|----------------|--------|
| JBX1MPA | Blue |
| JBX1MPB | White |
| JBX1MPG | Grey |
| JBX1MPJ | Yellow |
| JBX1MPM | Brown |
| JBX1MPN | Black |
| JBX1MPR | Red |
| JBX1MPV | Green |
| JBX1MPO | Orange |

The overall length is 25 mm/0.98" longer with the protective boot.
Note: The protective boot is not a sealing element.

Tooling for crimp contacts

Crimp tooling



Part number
M22520/7-01

Locator



| Part number | |
|--------------------|--------------------|
| Male | Female |
| JBX10UTLP07 | JBX10UTLS07 |

Extraction tool



Part number
JBX0UTDC07



JMX1-07 (7 x Ø 0.7 mm / 7 x Ø 0.027")

Contacts

| Ø 0.7 mm / Ø 0.027" | Contact type | Plating | Contact locking type | AWG |
|---------------------|--------------|-------------------------------|----------------------|----------------|
| Solder | Machined | 0.5 µm gold over 3 to 5 µm Ni | Fixed | 22 and smaller |
| Crimp | Machined | 0.5 µm gold over 3 to 5 µm Ni | Removable | 22 - 24 - 26 |

For more information see pages 55 to 56

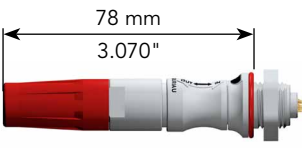
Mated connector length

| FH Plug + Receptacle | | |
|--|---|--|
|  <p>51 mm 2.007"</p> <p>with HH</p> |  <p>78 mm 3.070"</p> <p>with Boot and HH</p> |  <p>61 mm 2.401"</p> <p>with Overmolding and HH</p> |

Connector

| IEC / UL characteristics | |
|---|---------------------------------------|
| <p>IEC 5A 840 Vdc 1.5 kV 2</p> | <p>UL 5A 160V UL94 V-0</p> |

JMX1-08 (8 x Ø 0.7 mm / 8 x Ø 0.027")

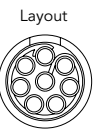

Connector part number (Products without color coding)

| Contact type | Connector type | Description | Part number | |
|--------------------------------|----------------|--------------------------------|------------------------|------------------------|
| | | | Male insert | Female insert |
| Solder contacts see page 43 | Receptacle | Front mount, nut fixing (HH) ☁ | JMXHH1G08MSUDSU | JMXHH1G08FSUDSU |
| | Plug | Straight plug (FH) * | JMXFH1G08MSUDSU | JMXFH1G08FSUDSU |
| Crimp contacts see page 43 | Receptacle | Front mount, nut fixing (HH) | JMXHH1G08MCUDSU | JMXHH1G08FCUDSU |
| | Plug | Straight plug (FH) * | JMXFH1G08MCUDSU | JMXFH1G08FCUDSU |

* In order to get the back nut version for protective boot, replace the "S" by a "M". Example: JMX Straight Plug, size 1, 8 solder contacts, male insert = JMXFH1G08MSUDMU. The protective boot need to be ordered separately. See page accessories.

☁ : Sealed in Unmated Condition

Overmolded cable assembly part number

| Layout | Description | Connector and overmold type | | Length* | | |
|--------|--------------------------------|-----------------------------|---------------|---------------------------|---------------------------|---------------------------|
| | | Connector | Overmold type | 1m / 39.370" | 2m / 78.740" | 3m / 118.110" |
| 1-08 | Plug overmolded cable assembly | Male plug | Straight | HAOJMXFH1G08MCU100 | HAOJMXFH1G08MCU200 | HAOJMXFH1G08MCU300 |
| | | Female plug | Straight | HAOJMXFH1G08FCU100 | HAOJMXFH1G08FCU200 | HAOJMXFH1G08FCU300 |

* : Other lengths or specific design requirement please consult us

JMX1-08 (8 x Ø 0.7 mm / 8 x Ø 0.027")

Dimensions (For mated connector lengths see page 43)

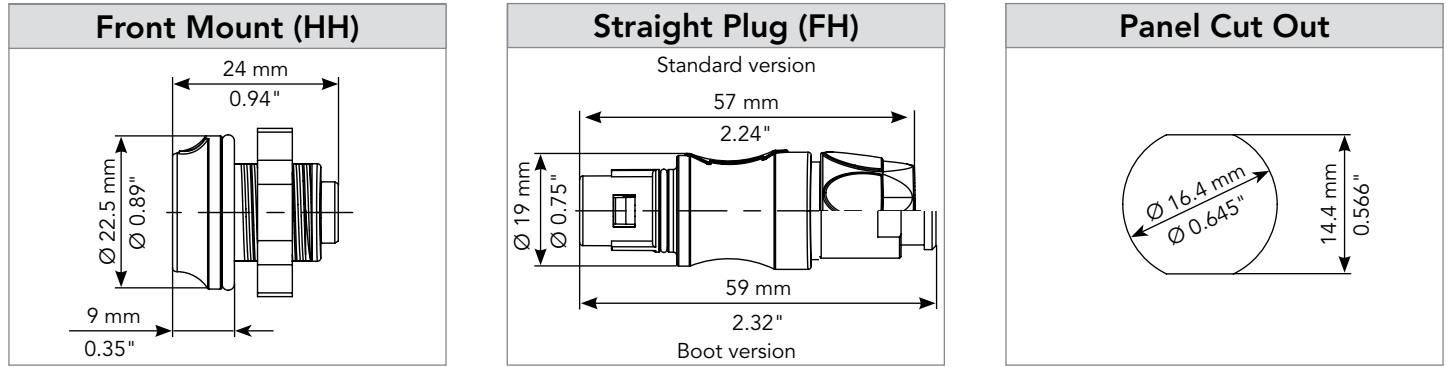

Connector color coding

| Color | Coding | Part number ⁽¹⁾ | | |
|--------|--------|----------------------------|-------------------|----------------------|
| | | Receptacle | Plug | Overmolded |
| None | U | JMXHH1G08 . .UDSU | JMXFH1G08 . .UDSU | HA0JMXFH1G08 . .U*** |
| Blue | A | JMXHH1G08 . .UDSA | JMXFH1G08 . .UDSA | HA0JMXFH1G08 . .A*** |
| Purple | P | JMXHH1G08 . .UDSP | JMXFH1G08 . .UDSP | HA0JMXFH1G08 . .P*** |
| Grey | G | JMXHH1G08 . .UDSG | JMXFH1G08 . .UDSG | HA0JMXFH1G08 . .G*** |
| Yellow | J | JMXHH1G08 . .UDSJ | JMXFH1G08 . .UDSJ | HA0JMXFH1G08 . .J*** |
| Brown | M | JMXHH1G08 . .UDSM | JMXFH1G08 . .UDSM | HA0JMXFH1G08 . .M*** |
| Black | N | JMXHH1G08 . .UDSN | JMXFH1G08 . .UDSN | HA0JMXFH1G08 . .N*** |
| Red | R | JMXHH1G08 . .UDSR | JMXFH1G08 . .UDSR | HA0JMXFH1G08 . .R*** |
| Green | V | JMXHH1G08 . .UDSV | JMXFH1G08 . .UDSV | HA0JMXFH1G08 . .V*** |
| Orange | O | JMXHH1G08 . .UDSO | JMXFH1G08 . .UDSO | HA0JMXFH1G08 . .O*** |

1: Standard HH receptacle is delivered without color identification. To order a receptacle or a plug with a color, replace the final "U" by the color code from the table above.
 ". .": first "." = gender, second "." = termination.
 "***": harness length = 100 (1m), 200 (2m) or 300 (3m).
 Example : JMXHH1G08MSUDSU (no color identification) => JMXHH1G08MSUDSV (Green color identification).

JMX1-08 (8 x Ø 0.7 mm / 8 x Ø 0.027")

Accessories

Receptacle dust cap



| |
|---------------|
| Part number |
| JMXBR1 |

Plug dust cap



| |
|---------------|
| Part number |
| JMXBF1 |

Plug protective boot

Available only for FH, with back nut protective boot 



| Part number | Color |
|----------------|--------|
| JBX1MPA | Blue |
| JBX1MPB | White |
| JBX1MPG | Grey |
| JBX1MPJ | Yellow |
| JBX1MPM | Brown |
| JBX1MPN | Black |
| JBX1MPR | Red |
| JBX1MPV | Green |
| JBX1MPO | Orange |

The overall length is 25 mm/0.98" longer with the protective boot.
 Note: The protective boot is not a sealing element.

Tooling for crimp contacts

Crimp tooling



| |
|--------------------|
| Part number |
| M22520/7-01 |

Locator



| | |
|--------------------|--------------------|
| Part number | |
| Male | Female |
| JBX10UTLP07 | JBX10UTLS07 |

Extraction tool



| |
|-------------------|
| Part number |
| JBX0UTDC07 |



JMX1-08 (8 x Ø 0.7 mm / 8 x Ø 0.027")

Contacts

| Ø 0.7 mm / Ø 0.027" | Contact type | Plating | Contact locking type | AWG |
|---------------------|--------------|-------------------------------|----------------------|----------------|
| Solder | Machined | 0.5 µm gold over 3 to 5 µm Ni | Fixed | 22 and smaller |
| Crimp | Machined | 0.5 µm gold over 3 to 5 µm Ni | Removable | 22 - 24 - 26 |

For more information see pages 55 to 56

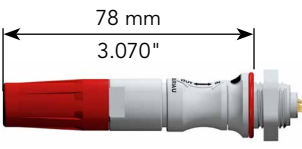
Mated connector length

| FH Plug + Receptacle | | |
|--|---|--|
|  <p>51 mm 2.007"</p> <p>with HH</p> |  <p>78 mm 3.070"</p> <p>with Boot and HH</p> |  <p>61 mm 2.401"</p> <p>with Overmolding and HH</p> |

Connector

| IEC / UL characteristics | |
|---|---------------------------------------|
| <p>IEC 5A 840 Vdc 1.5 kV 2</p> | <p>UL 5A 100V UL94 V-0</p> |

JMX1-10 (10 x Ø 0.5 mm / 10 x Ø 0.019")

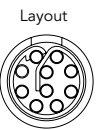

Connector part number (Products without color coding)

| Contact type | Connector type | Description | Part number | |
|--------------------------------|----------------|--------------------------------|------------------------|------------------------|
| | | | Male insert | Female insert |
| Solder contacts see page 47 | Receptacle | Front mount, nut fixing (HH) ☁ | JMXHH1G10MSUDSU | JMXHH1G10FSUDSU |
| | Plug | Straight plug (FH) * | JMXFH1G10MSUDSU | JMXFH1G10FSUDSU |

* In order to get the back nut version for protective boot, replace the "S" by a "M". Example: JMX Straight Plug, size 1, 10 solder contacts, male insert = JMXFH1G10MSUDMU. The protective boot need to be ordered separately. See page accessories.

☁ : Sealed in Unmated Condition

Overmolded cable assembly part number

| Layout | Description | Connector and overmold type | | Length* | | |
|--------|--------------------------------|-----------------------------|---------------|---------------------------|---------------------------|---------------------------|
| | | Connector | Overmold type | 1m / 39.370" | 2m / 78.740" | 3m / 118.110" |
| 1-10 | Plug overmolded cable assembly | Male plug | Straight | HAOJMXFH1G10MSU100 | HAOJMXFH1G10MSU200 | HAOJMXFH1G10MSU300 |
| | | Female plug | Straight | HAOJMXFH1G10FSU100 | HAOJMXFH1G10FSU200 | HAOJMXFH1G10FSU300 |

* : Other lengths or specific design requirement please consult us

JMX1-10 (10 x Ø 0.5 mm / 10 x Ø 0.019")

Dimensions (For mated connector lengths see page 47)

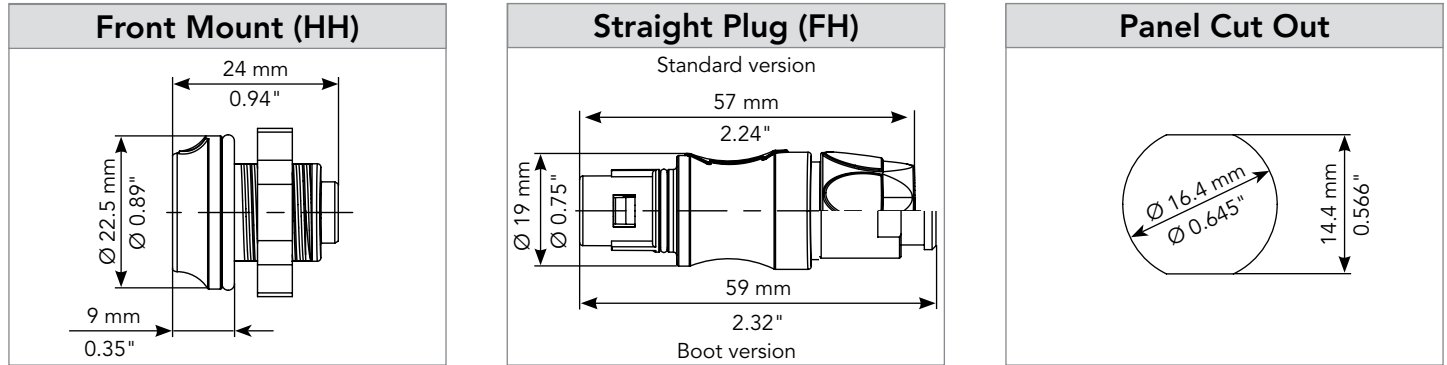

Connector color coding

| Color | Coding | Part number ⁽¹⁾ | | |
|--------|--------|----------------------------|-----------------|--------------------|
| | | Receptacle | Plug | Overmolded |
| None | U | JMXHH1G10 .UDSU | JMXFH1G10 .UDSU | HA0JMXFH1G10 .U*** |
| Blue | A | JMXHH1G10 .UDSA | JMXFH1G10 .UDSA | HA0JMXFH1G10 .A*** |
| Purple | P | JMXHH1G10 .UDSP | JMXFH1G10 .UDSP | HA0JMXFH1G10 .P*** |
| Grey | G | JMXHH1G10 .UDSG | JMXFH1G10 .UDSG | HA0JMXFH1G10 .G*** |
| Yellow | J | JMXHH1G10 .UDSJ | JMXFH1G10 .UDSJ | HA0JMXFH1G10 .J*** |
| Brown | M | JMXHH1G10 .UDSM | JMXFH1G10 .UDSM | HA0JMXFH1G10 .M*** |
| Black | N | JMXHH1G10 .UDSN | JMXFH1G10 .UDSN | HA0JMXFH1G10 .N*** |
| Red | R | JMXHH1G10 .UDSR | JMXFH1G10 .UDSR | HA0JMXFH1G10 .R*** |
| Green | V | JMXHH1G10 .UDSV | JMXFH1G10 .UDSV | HA0JMXFH1G10 .V*** |
| Orange | O | JMXHH1G10 .UDSO | JMXFH1G10 .UDSO | HA0JMXFH1G10 .O*** |

1: Standard HH receptacle is delivered without color identification. To order a receptacle or a plug with a color, replace the final "U" by the color code from the table above.

". . .": first "." = gender, second "." = termination.

"***": harness length = 100 (1m), 200 (2m) or 300 (3m).

Example : JMXHH1G10MSUDSU (no color identification) => JMXHH1G10MSUDSV (Green color identification).

JMX1-10 (10 x Ø 0.5 mm / 10 x Ø 0.019")

Accessories

Receptacle dust cap



| |
|---------------|
| Part number |
| JMXBR1 |

Plug dust cap



| |
|---------------|
| Part number |
| JMXBF1 |

Plug protective boot

Available only for FH, with back nut protective boot 



| Part number | Color |
|----------------|--------|
| JBX1MPA | Blue |
| JBX1MPB | White |
| JBX1MPG | Grey |
| JBX1MPJ | Yellow |
| JBX1MPM | Brown |
| JBX1MPN | Black |
| JBX1MPR | Red |
| JBX1MPV | Green |
| JBX1MPO | Orange |

The overall length is 25 mm/0.98" longer with the protective boot.
 Note: The protective boot is not a sealing element.



JMX1-10 (10 x Ø 0.5 mm / 10 x Ø 0.019")

Contacts

| Ø 0.5 mm / Ø 0.019" | Contact type | Plating | Contact locking type | AWG |
|---------------------|---------------|-------------------------------|----------------------|----------------|
| Solder | Machined | 0.5 µm gold over 3 to 5 µm Ni | Fixed | 28 and smaller |
| Crimp | Not available | | | |

For more information see pages 55 to 56

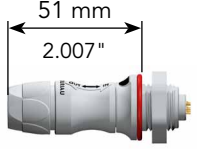
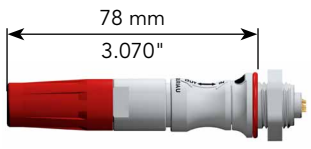
Mated connector length

| FH Plug + Receptacle | | |
|--|---|--|
|  <p>51 mm 2.007"</p> <p>with HH</p> |  <p>78 mm 3.070"</p> <p>with Boot and HH</p> |  <p>61 mm 2.401"</p> <p>with Overmolding and HH</p> |

| IEC / UL characteristics | |
|---|---|
| <p>IEC 2.5A 840 Vdc 1.5 kV 2</p> | <p>UL 2.5A 100V UL94 V-0</p> |

JMX1-12 (12 x Ø 0.5 mm / 12 x Ø 0.019")

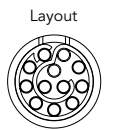

Connector part number (Products without color coding)

| Contact type | Connector type | Description | Part number | |
|--------------------------------|----------------|--------------------------------|------------------------|------------------------|
| | | | Male insert | Female insert |
| Solder contacts see page 51 | Receptacle | Front mount, nut fixing (HH) ☁ | JMXHH1G12MSUDSU | JMXHH1G12FSUDSU |
| | Plug | Straight plug (FH) * | JMXFH1G12MSUDSU | JMXFH1G12FSUDSU |

* In order to get the back nut version for protective boot, replace the "S" by a "M". Example: JMX Straight Plug, size 1, 12 solder contacts, male insert = JMXFH1G12MSUDMU. The protective boot need to be ordered separately. See page accessories.

☁ : Sealed in Unmated Condition

Overmolded cable assembly part number

| Layout | Description | Connector and overmold type | | Length* | | |
|--------|--------------------------------|-----------------------------|---------------|---------------------------|---------------------------|---------------------------|
| | | Connector | Overmold type | 1m / 39.370" | 2m / 78.740" | 3m / 118.110" |
| 1-12 | Plug overmolded cable assembly | Male plug | Straight | HA0JMXFH1G12MSU100 | HA0JMXFH1G12MSU200 | HA0JMXFH1G12MSU300 |
| | | Female plug | Straight | HA0JMXFH1G12FSU100 | HA0JMXFH1G12FSU200 | HA0JMXFH1G12FSU300 |

* : Other lengths or specific design requirement please consult us

JMX1-12 (12 x Ø 0.5 mm / 12 x Ø 0.019")

Dimensions (For mated connector lengths see page 51)

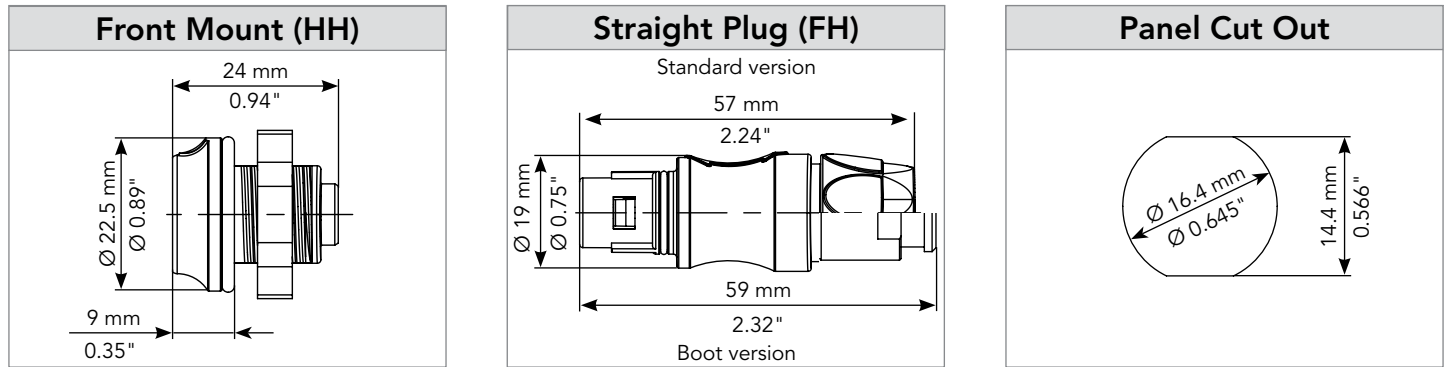

Connector color coding

| Color | Coding | Part number ⁽¹⁾ | | |
|--------|--------|----------------------------|-----------------|--------------------|
| | | Receptacle | Plug | Overmolded |
| None | U | JMXHH1G12..UDSU | JMXFH1G12..UDSU | HA0JMXFH1G12..U*** |
| Blue | A | JMXHH1G12..UDSA | JMXFH1G12..UDSA | HA0JMXFH1G12..A*** |
| Purple | P | JMXHH1G12..UDSP | JMXFH1G12..UDSP | HA0JMXFH1G12..P*** |
| Grey | G | JMXHH1G12..UDSG | JMXFH1G12..UDSG | HA0JMXFH1G12..G*** |
| Yellow | J | JMXHH1G12..UDSJ | JMXFH1G12..UDSJ | HA0JMXFH1G12..J*** |
| Brown | M | JMXHH1G12..UDSM | JMXFH1G12..UDSM | HA0JMXFH1G12..M*** |
| Black | N | JMXHH1G12..UDSN | JMXFH1G12..UDSN | HA0JMXFH1G12..N*** |
| Red | R | JMXHH1G12..UDSR | JMXFH1G12..UDSR | HA0JMXFH1G12..R*** |
| Green | V | JMXHH1G12..UDSV | JMXFH1G12..UDSV | HA0JMXFH1G12..V*** |
| Orange | O | JMXHH1G12..UDSO | JMXFH1G12..UDSO | HA0JMXFH1G12..O*** |

1: Standard HH receptacle is delivered without color identification. To order a receptacle or a plug with a color, replace the final "U" by the color code from the table above.

".": first "." = gender, second "." = termination.

"***": harness length = 100 (1m), 200 (2m) or 300 (3m).

Example : JMXHH1G12MSUDSU (no color identification) => JMXHH1G12MSUDSV (Green color identification).

JMX1-12 (12 x Ø 0.5 mm / 12 x Ø 0.019")

Accessories

Receptacle dust cap



| |
|-------------|
| Part number |
| JMXBR1 |

Plug dust cap



| |
|-------------|
| Part number |
| JMXBF1 |

Plug protective boot

Available only for FH, with back nut protective boot 



| Part number | Color |
|-------------|--------|
| JBX1MPA | Blue |
| JBX1MPB | White |
| JBX1MPG | Grey |
| JBX1MPJ | Yellow |
| JBX1MPM | Brown |
| JBX1MPN | Black |
| JBX1MPR | Red |
| JBX1MPV | Green |
| JBX1MPO | Orange |

The overall length is 25 mm/0.98" longer with the protective boot.
 Note: The protective boot is not a sealing element.



JMX1-12 (12 x Ø 0.5 mm / 12 x Ø 0.019")

Contacts

| Ø 0.5 mm / Ø 0.019" | Contact type | Plating | Contact locking type | AWG |
|---------------------|---------------|-------------------------------|----------------------|----------------|
| Solder | Machined | 0.5 µm gold over 3 to 5 µm Ni | Fixed | 28 and smaller |
| Crimp | Not available | | | |

For more information see pages 55 to 56

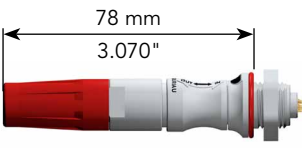
Mated connector length

| FH Plug + Receptacle | | |
|--|---|--|
|  <p>51 mm 2.007"</p> <p>with HH</p> |  <p>78 mm 3.070"</p> <p>with Boot and HH</p> |  <p>61 mm 2.401"</p> <p>with Overmolding and HH</p> |

| IEC / UL characteristics | |
|---|---|
| <p>IEC 2.5A 840 Vdc 1.5 kV 2</p> | <p>UL 2.5A 100V UL94 V-0</p> |

JMX SERIES

Contacts

| | |
|-------------------------|----|
| ■ Description | 54 |
| ■ Packaging | 54 |
| ■ Solder contacts | 55 |
| ■ Crimp contacts | 56 |
| ■ Tooling | 57 |



Contacts

Description

The JMX Series is delivered with golded machined contacts to ensure the 2,000 cycles mating/unmating resistance. SOURIAU contacts are designed for simple snap-in installation and therefore eliminate the need for insertion tooling.

Please note that solder contacts diam 0.7 mm and diam 0.5 mm are not available in spare parts



• Solder



• Crimp

Packaging for contacts. Not available for solder contacts Ø 0.7 mm & Ø 0.5 mm

Due to the wide variety of applications, contact packaging is offered in bulk package.



• 100 pieces loose package

Solder contacts

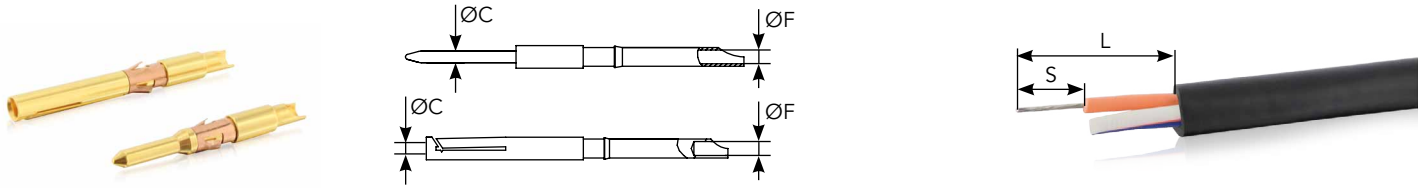

| Contact size ØC | ØF | | Wire size (Stranded) | | Part number | | Max current rating (A) | Contact resistance (mΩ) |
|----------------------------|------|--------|----------------------|------------------------|---------------|---------------|------------------------|-------------------------|
| | mm | inch | AWG (maxi) | mm ² (maxi) | Male | Female | | |
| #24 Ø 0.5 mm / Ø 0.019" | 0.50 | 0.019" | 28 | 0.09 | Not available | Not available | 5 | 10 |
| #22 Ø 0.7 mm / Ø 0.027" | 0.80 | 0.031" | 22 | 0.34 | Not available | Not available | 7 | 5 |
| #20 Ø 0.9 mm / Ø 0.035" | 0.80 | 0.031" | 22 | 0.34 | JBX1CTMS09 | JBX1CTFS09 | 10 | 3.5 |
| #18 Ø 1.3 mm / Ø 0.051" | 1.10 | 0.043" | 20 | 0.50 | JBX1CTMS13 | JBX1CTFS13 | 15 | 3 |

* Part numbers for removal contacts only

Wire stripping instructions

| Contact size | L | | S | |
|----------------------------|----|--------|-----|--------|
| | mm | inch | mm | inch |
| #24 Ø 0.5 mm / Ø 0.019" | 20 | 0.790" | 2 | 0.079" |
| #22 Ø 0.7 mm / Ø 0.027" | 20 | 0.790" | 3 | 0.118" |
| #20 Ø 0.9 mm / Ø 0.035" | 20 | 0.790" | 3 | 0.118" |
| #18 Ø 1.3 mm / Ø 0.051" | 20 | 0.790" | 3.5 | 0.138" |

Crimp contacts (Not available in Ø 0.5 mm versions)

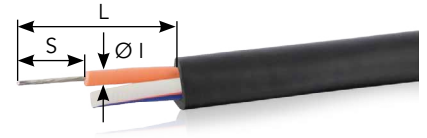
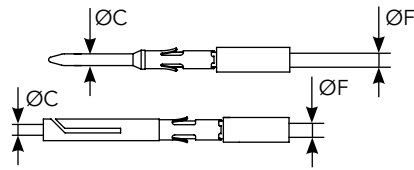

| Contact size ØC | ØF | | Wire size (Stranded) | | Part number* | | Max current rating (A) | Contact resistance (mΩ) |
|---------------------------|------|--------|----------------------|----------------------------|-------------------|-------------------|------------------------|-------------------------|
| | mm | inch | AWG (min-maxi) | mm ² (min-maxi) | Male | Female | | |
| #22 Ø 0.7 mm/ Ø 0.027" | 0.85 | 0.033" | 26-22 | 0.14-0.34 | JBX1CTMC07 | JBX1CTFC07 | 7 | 5 |
| #20 Ø 0.9 mm/ Ø 0.035" | 1.10 | 0.043" | 24-20 | 0.25-0.50 | JBX1CTMC09 | JBX1CTFC09 | 10 | 3.5 |
| #18 Ø 1.3 mm/ Ø 0.051" | 1.40 | 0.055" | 22-18 | 0.50-1.00 | JBX1CTMC13 | JBX1CTFC13 | 15 | 3 |

* Part numbers for removal contacts only

Wire stripping instructions

| Contact size | Ø I (diameter over insulation) | | L | | S | |
|---------------------------|--------------------------------|----------|----|--------|-----|--------|
| | mm | inch | mm | inch | mm | inch |
| #22 Ø 0.7 mm/ Ø 0.027" | > 1.35 | ≤ 0.053" | 20 | 0.790" | 4 | 0.157" |
| | > 1.35 | > 0.053" | | | 5.5 | 0.217" |
| #20 Ø 0.9 mm/ Ø 0.035" | ≤ 1.60 | ≤ 0.062" | 20 | 0.790" | 4 | 0.157" |
| | > 1.60 | > 0.062" | | | 5.5 | 0.217" |
| #18 Ø 1.3 mm/ Ø 0.051" | ≤ 2.10 | ≤ 0.082" | 20 | 0.790" | 4 | 0.157" |
| | > 2.10 | > 0.082" | | | 5.5 | 0.217" |

Tooling

Crimp tool table

Crimp contacts

| Contact size | Shell type | Part number* | | Crimp tooling | Locator | | Extraction tools |
|---------------------------|------------|--------------|------------|----------------|-------------|-------------|------------------|
| | | Male | Female | | Male | Female | |
| #22 Ø 0.7 mm/ Ø 0.027" | 1 | JBX1CTMC07 | JBX1CTFC07 | MIL-22520/7-01 | JBX10UTLP07 | JBX10UTLS07 | JBXOUTDC07 |
| #20 Ø 0.9 mm/ Ø 0.035" | 1 | JBX1CTMC09 | JBX1CTFC09 | MIL-22520/7-01 | JBX10UTLP09 | JBX10UTLS09 | JBXOUTDC09 |
| #18 Ø 1.3 mm/ Ø 0.051" | 1 | JBX1CTMC13 | JBX1CTFC13 | MIL-22520/7-01 | JBX10UTLP13 | JBX10UTLS13 | JBXOUTDC13 |

* Part numbers for removal contacts only

Contact extraction instruction

- Place the tool into the cavity from front face of the insulator
- Push on the handle
- Remove the contact by pulling on it.



JMX SERIES

Technical Information

| | |
|--|----|
| ■ Receptacle assembly instructions | 60 |
| ■ Plug assembly instructions | 61 |
| ■ Which Standard to select ? | 62 |
| ■ UL94 + UL1977 | 63 |
| ■ IEC 61984 & IP codes explained | 66 |
| ■ What is NEMA Rating ? | 68 |
| ■ What is CE Marking ? | 68 |
| ■ Sterilization | 69 |
| ■ Ethernet for the Layman | 70 |

JMX receptacle assembly instructions

JMXHH assembly (mounting suggestion)

- 1) Solder or crimp the wires to the contacts (see pages 55 & 56)
- 2) Check carefully the presence of the o-ring on the receptacle
- 3) Place the receptacle in the panel cut out. Make sure the panel thickness is inferior to E maxi
- 4) Screw the hex nut to the bulkhead with a wrench according the recommended tightening torque
- 5) Insert contacts manually in the cavities for removable contacts versions

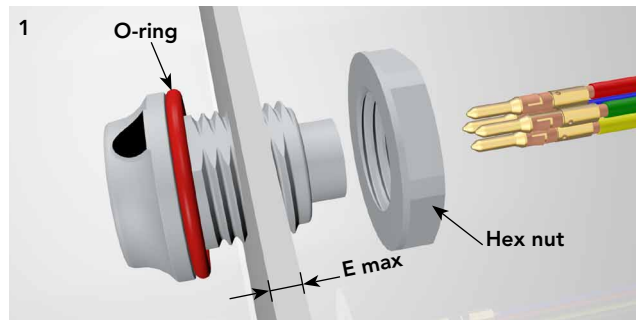

| Tightening torque (Nm) maxi | Wrench size | E Panel maxi thicknesses | |
|--------------------------------|-------------|-----------------------------|--------|
| | | mm | inch |
| 2.5 | 22 mm | 8 | 0.177" |

JMX plug assembly instructions

JMXFH assembly (mounting suggestion)

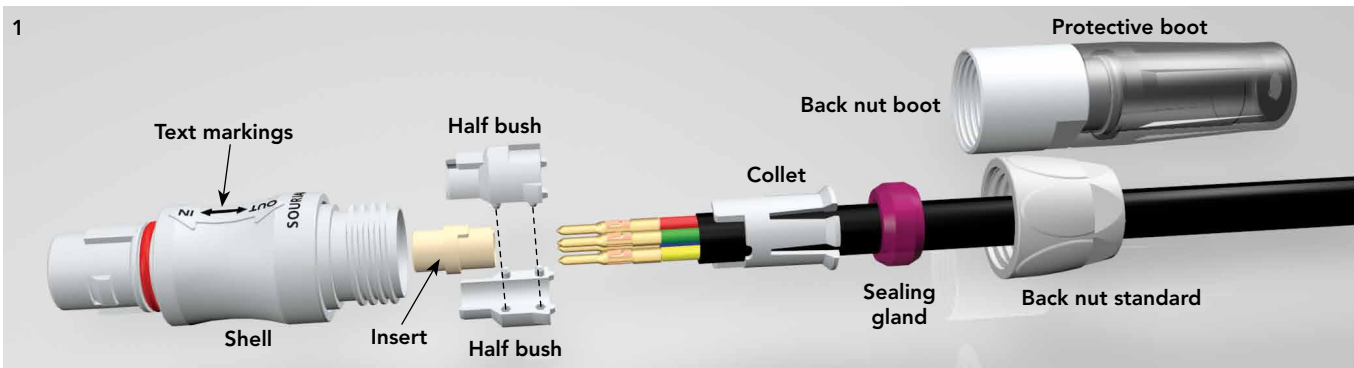

- 1) Slide the backnut, the sealing gland and the appropriate collet onto the cable. See sealing gland and collet table for the diameter choice.
- 2) Strip the external cable jacket and wires (see dimensions pages 55 & 56)
- 3) Solder or crimp the wires to the contacts (see pages 55 & 56).
For removable contacts, insert them manually in the insert
- 4) Place the two half bushes on the insert by aligning the insert keyway and the half bush rib (fig. 2)
- 5) Place the collet making sure that the collet tabs come against the rear face of the halfbushes. The collet will be used as a tool to push the insert inside the shell (fig. 2)
- 6) Place the plug front face against a flat and hard surface (fig. 3)
- 7) With the help of the collet and the sealing gland, push all the sub-assembly in the connector shell until hearing an audible click. Ensure that the rib and the keyways of the half bushes are correctly aligned with the shell keyway (fig. 3)
- 8) Rotate slightly the collet (fig. 4) and push it ensuring an alignment between the letter (fig. 5) and one of the shell flat.
- 9) Slide the sealing gland against the collet and screw the backnut with a wrench according the recommended tightening torque

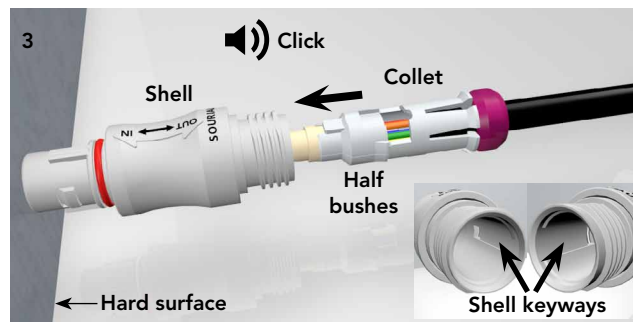
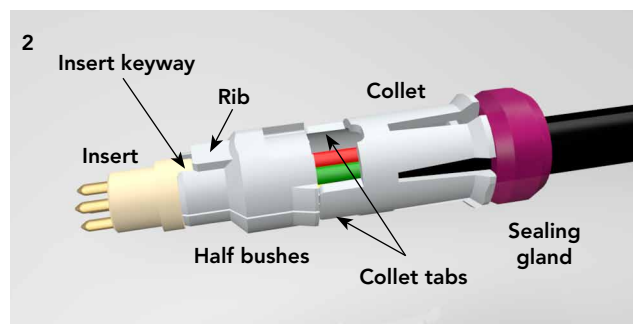

Note: For mass production SOURIAU have available tools to avoid proceeding to the step #7. Please consult us if needed.

| Collet selection & sealing gland | |
|----------------------------------|--------|
| Ø cable maxi | Indice |
| 7.5mm/0.295" | A |
| 6.15mm/0.242" | B |
| 4.8mm/0.189" | C |
| 3.5mm/0.138" | D |

| Back nut wrench | |
|------------------|-------------|
| Wrench size (mm) | Torque (Nm) |
| 14 | 1.5 |

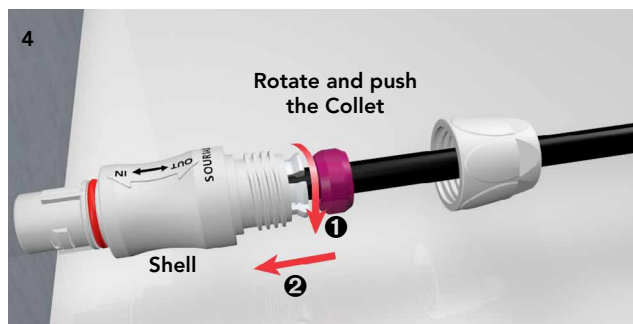
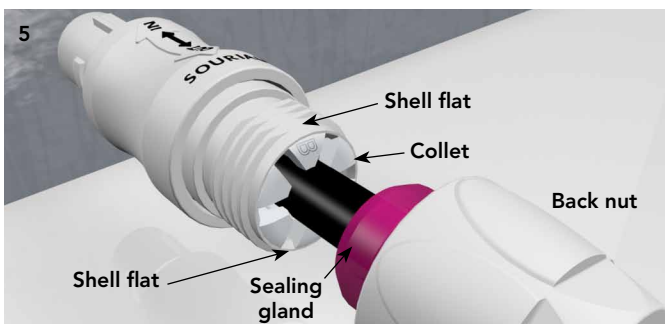

Note: Assembly operations mentioned above shall not interfere or to be in contradiction with the IPC-WHMA-A-620B

Which Standard to select ?

Standard qualification benefits:

Safety and essential performance requirements for "Medical electrical equipments" are defined by the general standard IEC 60601-1. It is a requirement for the commercialization of electrical medical equipments. Compliance to the IEC 60601-1 requests a qualification to component standards as the connector standards UL 1977 (US) and IEC 61984 (Europe). It avoids to re-proceed to a full qualification of the connectors and simplifies the equipment qualification process. JMX connectors are compliant to the UL 1977 and IEC 61984 and therefore ensure a fully compliance with the IEC 60601-1.

IEC 60601-1
General Standard
Medical Electrical Equipment



UL 60601
North America Standard
Medical Electrical Equipment



EN 60601
European Standard
Medical Electrical Equipment



UL 1977 / CSA 22.2
North America Standard



IEC 61984
(SOURIAU relevant standard)
European Connector Standard

UL94 + UL1977

Underwriter laboratories



There are two main standards for industrial connectors: UL94 & UL1977

UL94

This standard is dedicated to plastics flammability. It characterizes how the material burns in various orientation and thicknesses.

The JMX Plastic series is rated at **V-0**.

Procedure: A specimen is supported in a vertical or horizontal position and a flame is applied to the bottom of the specimen. The flame is applied for ten seconds and then removed until flaming stops, at which time the flame is reapplied for another ten seconds and then removed. Two sets of five specimens are tested.

More details on the Flammability UL 94 could be found on the following link:
www.ultrc.com/en/solutions/test-methods/combustion-fire.html

V-0 Vertical burning:

- Specimens must not burn with flaming combustion for more than 10 seconds after each test flame application
- Total flaming combustion time must not exceed 50 seconds for each set of 5 specimens
- Specimens must not burn with flaming or glowing combustion up to the specimen holding clamp
- Specimens must not drip flaming particles that ignite the cotton
- No specimen can have glowing combustion remain for longer than 30 seconds after removal of the test flame.

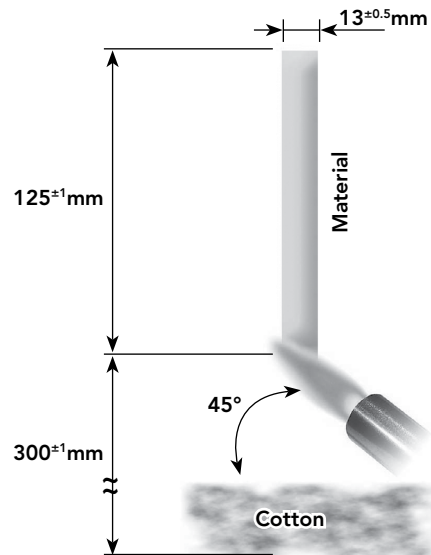

UL94 + UL1977



UL1977

The connector standard UL1977 covers single and multipole connectors intended for factory assembly. Requirements apply to devices taking into account intensity and voltage. The categories are as follow:

| | 0 | 30 V (42 V peak) | 600 V | 6000 V |
|--------|---------|---------------------|--------|--------|
| 0 | Type 0 | Type 1A | Type 5 | |
| 8.3 A | | | | |
| 31 A | Type 1B | Type 2 | Type 5 | |
| 200 A | | Type 3 | | |
| 1000 A | Type 4 | | | |

According to above table, the level of performance to be reached could be different. Most of them are explained in the following page.

Insulating materials:

For all the types described in the above table, JMX inserts are rated V0 and have a RTI of 130°C / 266°F.

Assembly:

Connector has to be keyed to prevent any mismatching that can damage the machine or hurt the user. In the same way, plugs and sockets have to be equipped to protect persons against contact with live parts.

UL94 + UL1977



UL1977

Spacing / Dielectric Withstanding Voltage:

UL1977 defines minimum clearance and creepage distances for voltage below and above 250V. An alternative way to determine voltage rating is the Dielectric Withstanding Voltage (DWW) test. No arc-over or breakdown must occur during one minute.

Different Dielectric Withstanding Voltage requirements shall be considered depending on the connector type. DWW requirement are shown in the table below.

• **Applicability of spacing requirements**

| Type | Current rating (A) | U=Voltage rating (Vrms) | Dielectric Withstanding Voltage requirement to considered (during 1 minute) |
|------|--------------------|-------------------------|---|
| 0 | 0 to 8.3 | 0 to 30 | No requirement for type 0 |
| 1A | 0 to 8.3 | 30 to 600 | 2U+1,000 |
| 1B | 8.3 to 200 | 0 to 30 | 500V Minimum |
| 2 | 8.3 to 31 | 30 to 600 | 2U+1,000 |
| 3 | 31 to 200 | 30 to 600 | 2U+1,000 |
| 4 | 200 to 1,000 | 0 to 600 | 2U+1,000 |
| 5 | 0 to 31 | 600 to 6,000 | 2,200V Minimum |

Marking:

A device shall be legibly marked with the manufacturer's trade name, trade mark, or other descriptive marking by which the organization responsible for the product may be identified. (Exception: If the device is too small, or where the legibility would be difficult to attain, the manufacturer's name, trademark, or other descriptive marking may appear on the smallest unit container or carton)

The following shall be marked on the device or on the smallest unit container or carton or on a stuffer sheet in the smallest unit container or carton:

- a) The catalog number or an equivalent designation
- b) The electrical rating in both volts and amperes, if assigned
- c) Whether ac or dc, if restricted
- d) Flammability class, if identified

Example - Marking for the 2 contacts layout:

10A 300V UL94 V-0

IEC 61984 & IP codes explained

IEC 61984

This standard is dedicated to connectors with rated voltage above 50V and up to 1000V and rated currents up to 125A per contact. Depending on your application connectors should be compliant with another standard. This has to be double checked with the customer.

There are a lot of constructional requirements and performances specified in that standard. Most of them are illustrated in greater details hereafter.

IP code:

IP is a coding system defined by the IEC 60529 to indicate the degrees of protection provided by an enclosure. The aim of this is to give information regarding the accessibility of live parts against ingress of water and other foreign bodies.

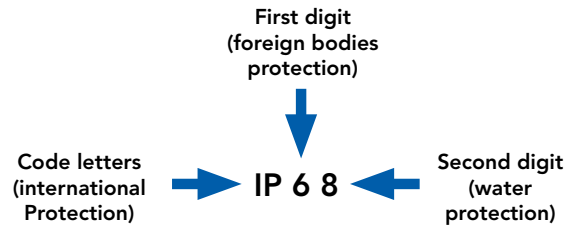

| 1 st digit | Degree of protection | 2 nd digit | Degree of protection |
|-----------------------|---|-----------------------|--|
| 0 | No protection against accidental contact. No protection against solid foreign bodies. | 0 | No protection against water. |
| 1 | Protection against contact with any large area by hand and against large solid foreign bodies with a diameter bigger than 50 mm. | 1 | Drip-proof. Protection against vertical water drips. |
| 2 | Protection against contact with the fingers. Protection against solid foreign bodies with a diameter bigger than 12 mm. | 2 | Drip-proof. Protection against water drips up to a 15° angle. |
| 3 | Protection against tools, wires or similar objects with a diameter bigger than 2.5 mm. Protection against small solid bodies with a diameter bigger than 2.5 mm. | 3 | Spray-proof. Protection against diagonal water drips up to a 60° angle. |
| 4 | Same as 3 however diameter is bigger than 1 mm. | 4 | Splash-proof. Protection against splashed water from all directions. |
| 5 | Full protection against contact. Protection against interior injurious dust deposits. | 5 | Hose-proof. Protection against water (out of a nozzle) from all directions. |
| 6 | Total protection against contact. Protection against penetration of dust. | 6 | Protection against temporary flooding. |
| | | 7 | Protection against temporary immersions. |
| | | 8 | Protection against water pressure. Pressure to be specified by supplier. |

JMX offers high sealing performance IP68 (1bar during 1 week):
 - In mated condition Plug + Receptacle
 - In mated condition with the caps
 - In unmated condition for solder Receptacles

IEC 61984 ed.2.0 "Copyright © 2008 IEC Geneva, Switzerland.www.iec.ch"
 IEC 60664-1 ed.2.0 "Copyright © 2007 IEC Geneva, Switzerland.www.iec.ch"

IEC 61984 & IP codes explained

IEC 61984

Overvoltage

Per the IEC 60664-1 (formerly VDE 0110) each category is linked to the end application and where the device will be implemented:

- **Category IV** (primary overcurrent protection equipment):
Origin of the installation
- **Category III** (Any fixed installation with a permanent connection)
Fixed installation and equipment and for cases where the reliability and the availability is subject to special requirements
- **Category II** (Domestic appliances):
Energy consuming equipment to be supplied from the fixed installation
- **Category I** (Protected electronic circuit):
For connection to circuit in which measures are taken to limit transient overvoltage.

The "Nominal Voltage" will define for what category JMX connectors could be used. The "Rated Impulse voltage" of the JMX is 1500V. Below a table showing the applicable categories:

| Nominal voltage of the supply system based on IEC 60038 | | Voltage line to neutral derived from nominal voltages a.c. or d.c. up to and including V | Rated impulse voltage | | | |
|---|--------------|--|--------------------------|-------|-------|--------|
| Three phase | Single phase | | Overvoltage category (V) | | | |
| | | | I | II | III | IV |
| | | 50 | 330 | 500 | 800 | 1,500 |
| | | 100 | 500 | 800 | 1,500 | 2,500 |
| | 120-240 | 150 | 800 | 1,500 | 2,500 | 4,000 |
| 230/400 277/480 | | 300 | 1,500 | 2,500 | 4,000 | 6,000 |
| 400/690 | | 600 | 2,500 | 4,000 | 6,000 | 8,000 |
| 1,000 | | 1,000 | 4,000 | 6,000 | 8,000 | 12,000 |

■ Nominal Voltage ■ Rated Impulse Voltage ■ Non recommended voltage

Pollution degree

Per the IEC 60664-1 (formerly VDE 0110) the environment affects the performance of the insulation. Particles can build a bridge between two metal parts. As a rule dust mixed with water can be conductive and more generally speaking metal dust is conductive. Finally, the standard defines 4 levels of pollution:

- **Degree 1** (Air conditioned dry room):
No pollution or only dry, non conductive pollution occurs. The pollution has no influence.
- **Degree 2** (Personal computer in a residential area):
Only non conductive pollution occurs except that occasionally a temporary conductivity caused by condensation is to be expected.
- **Degree 3** (Machine tools):
Conductive pollution occurs or dry non-conductive pollution occurs which becomes conductive due to condensation which is to be expected.
- **Degree 4** (Equipments on roof, locomotives):
Continuous conductivity occurs due to conductive dust, rain or other wet conditions.

Finally, the harsher the environment is, the longer clearance and creepage distances should be.

Marking

The marking should give enough details to the user to know what the main characteristics are and without going deep in technical documentation. Below is an example of how JMX packagings are marked.

Rated current 10A, working voltage 840 Vdc, rated Impulse voltage 1.5kV, Pollution degree 2

10A 840 Vdc 1.5 kV 2

What is NEMA Rating ?

- NEMA ratings vs IP ratings

Whereas IP ratings only consider protection against ingress of foreign bodies (first digit) and ingress of water (second digit), NEMA ratings consider these but also verify protection from external ice, corrosive materials, oil immersion, etc.

The correlation between NEMA & IP being limited only to dust and water, we can state that a NEMA type is equivalent to an IP rating but it is not possible to say the contrary.

Below a list of some NEMA standards:

| Enclosure rating | IP20 | IP22 | IP55 | IP64 | IP65 | IP66 | IP67 | IP68 |
|------------------|------|------|------|------|------|------|------|------|
| Type 1 | • | | | | | | | |
| Type 3 | | | | • | | | | |
| Type 3R | | • | | | | | | |
| Type 3S | | | | • | | | | |
| Type 4 | | | | | | • | | |
| Type 4X | | | | | | • | | |
| Type 6 | | | | | | | • | |
| Type 6P | | | | | | | | • |
| Type 12 | | | • | | | | | |
| Type 13 | | | | | • | | | |

• indicates compliance



Type 6 rating can be either Type 6 or Type 6P - please see below:

| | | |
|----|------|---|
| 6 | IP67 | Enclosures constructed for either indoor or outdoor use to provide a degree of protection to personnel against incidental contact with the enclosed equipment, falling dirt, hose-directed water, the entry of water during occasional temporary submersion at a limited depth and damage from external ice formation. |
| 6P | IP68 | Enclosures constructed for either indoor or outdoor use to provide a degree of protection to personnel against incidental contact with the enclosed equipment, falling dirt, hose-directed water, the entry of water during prolonged submersion at a limited depth and damage from external ice formation. |

What is C€ Marking ?

CE marking means that the device complies with the European safety directives.

CE marking **does not apply to components such as connectors** but only on complete equipment.

Sterilization

Steam autoclave sterilization:

JMX connectors withstand up to 200 cycles on steam autoclave sterilization according to gravitation or pre-vacuum process per EN13060.

Both processes are described below:

- Gravity process: Steam displaces air in the chamber by gravity through a drain port.
- Pre-vacuum process: The air is removed from the chamber and steam is injected through a series of vacuum and pressure pulses. This allows the steam to penetrate porous areas of the load that could not otherwise be reached with simple gravity displacement.

Cycle is defined at 134°C / 273.2°F during 4 min.

JMX is qualified to ensure a Sterility Assurance Level (SAL) of 10^{-6} for re-usable medical devices sterilized according to ISO 14937 & ISO 17665-1 with a pre-vacuum process.

For other sterilization processes, please contact us.

SOURIAU is equipped with autoclave devices to proceed with additional tests if needed.



Ethernet for the Layman

In order to explain basic Ethernet theory, we can use a functional comparison to a busy city with highways, buildings and cars. To illustrate this, the table below provides correlation between the different components/pieces/links that encompass Ethernet network connectivity, and the larger scale infrastructure of a metropolitan city.

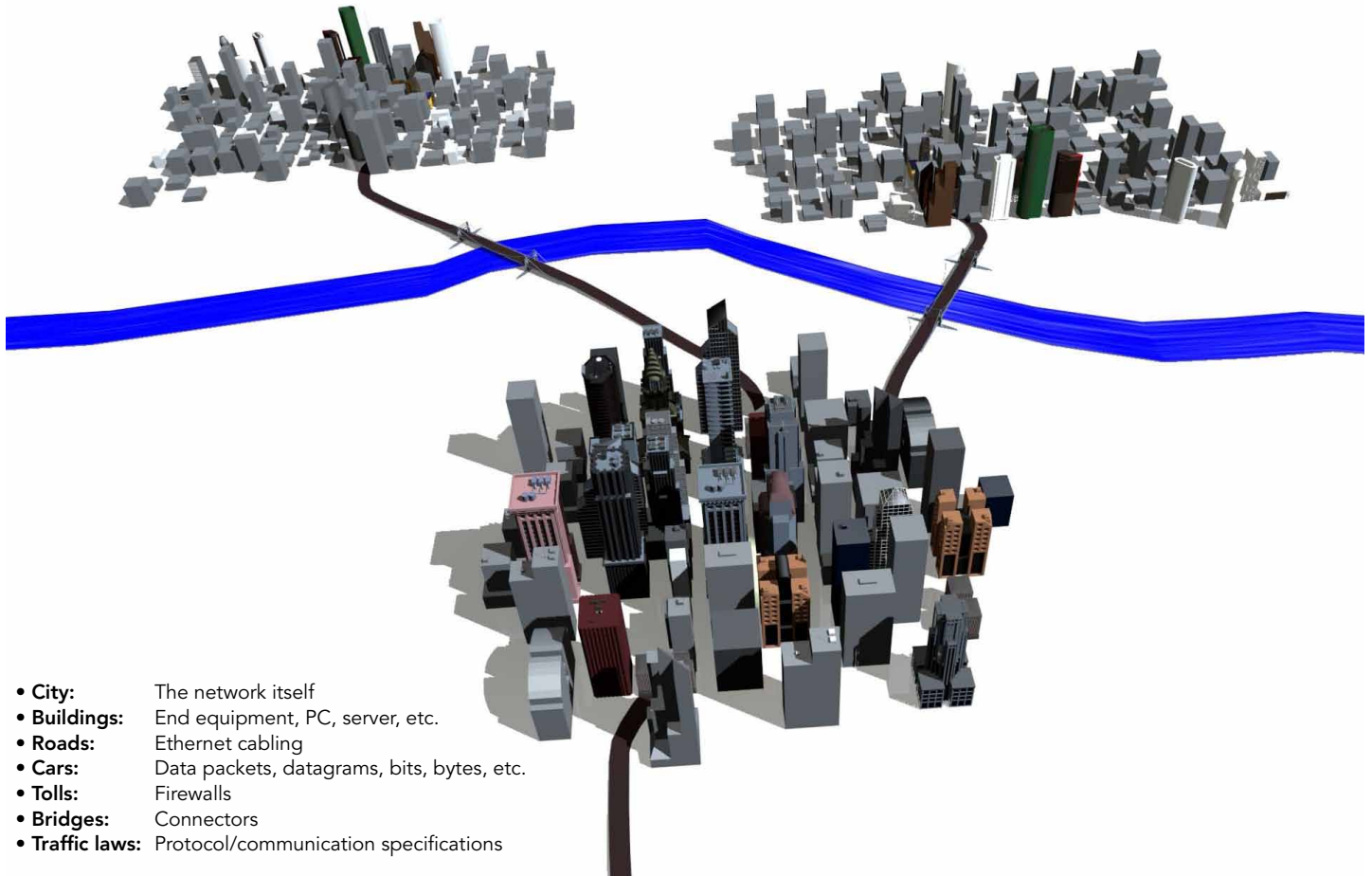

- **City:** The network itself
- **Buildings:** End equipment, PC, server, etc.
- **Roads:** Ethernet cabling
- **Cars:** Data packets, datagrams, bits, bytes, etc.
- **Tolls:** Firewalls
- **Bridges:** Connectors
- **Traffic laws:** Protocol/communication specifications

Ethernet Basics

Ethernet is a widely used communications protocol that is used to transmit data packets (datagrams) between network devices. Imagine a highway in a large metropolitan area six lanes wide at rush hour. The vehicles on the highway need rules to follow so that they get to their destination without crashing into each other. In an Ethernet network link, there could be 100 million bits of information transmitted in one second. In the Ethernet standard, there exist rules to govern packet structure, transmission requirements, error correction, communication with end equipment, etc.

Examining the differences between 100Mhz, 100 Base TX, Cat5e/Cat6. What does it all mean?

When discussing connectors and Ethernet, there are a few key details to be aware of:

- 100Mhz is a measurement of Frequency for the signal
 - Comparable to the Speed Limit of a highway
- 100BaseTX (or Fast Ethernet) is an Ethernet link standard and identifies available link bandwidth. The bandwidth is measured in units of Mbits/S (megabits per second)
 - Comparable to the number of cars that pass a point in one second
- Cat5e/Cat6 are an EIA/TIA standard for performance and physical characteristics for cables and connectors
 - Comparable to performance specifications of the car and highway.

In connectors and cables, Fast Ethernet uses 2 pairs. One for transmit and one for receive. This way data traffic can flow in both directions simultaneously.

Notes

A large grid area for taking notes, consisting of 20 columns and 30 rows of small squares.

JMX SERIES

Appendices

| | |
|---------------------------|----|
| ■ Glossary of Terms | 74 |
| ■ Safety notice | 75 |
| ■ Part Number Index | 76 |



Glossary of terms

- **Clearance**

Per the IEC 60664-1 it is the shortest distance between two conductive parts even over the air.

- **Creepage distance**

Per the IEC 60664-1 it represents the shortest distance along the surface of the insulating material between two conductive parts.

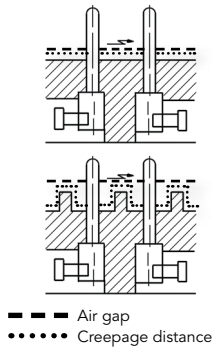

- **Test Voltage**

Measured according to the IEC 60512-2 test 4a, Test voltage corresponds to 75% of the mean dielectric withstanding voltage.

Operating voltage: It could be calculated following the method:

$$\frac{\text{Test Voltage}}{3}$$

- **Rated impulse voltage**

Impulse withstands voltage value assigned by the manufacturer to the equipment or to a part of it characterizing the specified withstand capability of its insulation against transient overvoltage.

- **Working current**

It is the maximum continuous and not interrupted current able to be carried by all contacts without exceeding the maximum temperature of the insulating material.

- **Transient voltage**

Extract from the IEC 60664-1: Short duration overvoltage of a few millisecond or less, oscillatory or non-oscillatory, usually highly damped.

- **CTI (Comparative Tracking Index)**

The CTI value is commonly used to characterize the electrical breakdown properties of an insulating material. It allows users to know the tendency to create creepage paths. This value represents the maximum voltage after 50 drops of ammonium chloride solution without any breakdown.

- **RTI (Relative temperature Index):**

Extract from ULs website:

Maximum service temperature for a material, where a class of critical property will not be unacceptably compromised through chemical thermal degradation, over the reasonable life of an electrical product, relative to a reference material having a confirmed, acceptable corresponding performance defined RTI.

- **RTI Elec:** Electrical RTI, associated with critical electrical insulating properties.
- **RTI Mech Imp:** Mechanical Impact RTI, associated with critical impact resistance, resilience and flexibility properties.
- **RTI Mech Str:** Mechanical Strength (Mechanical without Impact) RTI, associated with critical mechanical strength where impact resistance, resilience and flexibility are not essential.

Safety notice

Please read and follow all instructions carefully. Relevant national and international safety regulations must be considered for your application. Improper use of connectors can result in hazardous situations.

1 - Electrical safety

Short circuits, overheating, risk of electrical shock could be generated for the following situations:

- Improper mating of the connector
- Incorrect wiring
- Presence of foreign objects such as metal debris or liquid residue
- Damaged components

Mated components should never be disconnected while live as this may result in an exposed electric arc and local overheating, resulting in possible damage to components.

Connectors with exposed electrical contacts should never be installed on the live side of the circuit. Under normal conditions voltages above 30 VAC/42 VDC are considered dangerous and proper precautions should be taken to eliminate all risk of transmission of such voltages to any exposed metal part of the connector

The maximum admissible operating voltage depends upon the national or international standards in force for the application in question. Air and creepage distances impact the operating voltage; reference values are indicated in the catalog however these may be influenced by PC board design and / or wiring harnesses.

2 - Installation

Esterline – SOURIAU cannot ensure the correct functionality of the connectors if proper tools are not used for the installation/assembly. Connectors and their components should be visually inspected for damage prior to installation and assembly. Connector assembly and installation should only be carried out by properly trained personnel.

3 - CE marking

CE marking means that the device complies with the European safety directives.

CE marking does not apply to components such as connectors but only on complete equipment.

4 - Product improvements

Esterline - SOURIAU reserves the right to modify and improve to our products or specifications without providing prior notification.

Part number index

Connectors

JMXFH1G02FCUDSU P. 16
 JMXFH1G02FSUDSU P. 16
 JMXFH1G02MCUDSU P. 16
 JMXFH1G02MSUDSU P. 16
 JMXFH1G03FCUDSU P. 20
 JMXFH1G03FSUDSU P. 20
 JMXFH1G03MCUDSU P. 20
 JMXFH1G03MSUDSU P. 20
 JMXFH1G04FCUDSU P. 24
 JMXFH1G04FSUDSU P. 24
 JMXFH1G04MCUDSU P. 24
 JMXFH1G04MSUDSU P. 24
 JMXFH1G05FCUDSU P. 28
 JMXFH1G05FSUDSU P. 28
 JMXFH1G05MCUDSU P. 28
 JMXFH1G05MSUDSU P. 28
 JMXFH1G06FCUDSU P. 32
 JMXFH1G06FSUDSU P. 32
 JMXFH1G06MCUDSU P. 32
 JMXFH1G06MSUDSU P. 32
 JMXFH1G07FCUDSU P. 36
 JMXFH1G07FSUDSU P. 36
 JMXFH1G07MCUDSU P. 36
 JMXFH1G07MSUDSU P. 36
 JMXFH1G08FCUDSU P. 40
 JMXFH1G08FSUDSU P. 40
 JMXFH1G08MCUDSU P. 40
 JMXFH1G08MSUDSU P. 40
 JMXFH1G10FSUDSU P. 44
 JMXFH1G10MSUDSU P. 44
 JMXFH1G12FSUDSU P. 48
 JMXFH1G12MSUDSU P. 48
 JMXHH1G02FCUDSU P. 16
 JMXHH1G02FSUDSU P. 16
 JMXHH1G02MCUDSU P. 16
 JMXHH1G02MSUDSU P. 16
 JMXHH1G03FCUDSU P. 20
 JMXHH1G03FSUDSU P. 20
 JMXHH1G03MCUDSU P. 20
 JMXHH1G03MSUDSU P. 20
 JMXHH1G04FCUDSU P. 24
 JMXHH1G04FSUDSU P. 24
 JMXHH1G04MCUDSU P. 24
 JMXHH1G04MSUDSU P. 24
 JMXHH1G05FCUDSU P. 28
 JMXHH1G05FSUDSU P. 28
 JMXHH1G05MCUDSU P. 28
 JMXHH1G05MSUDSU P. 28
 JMXHH1G06FCUDSU P. 32
 JMXHH1G06FSUDSU P. 32
 JMXHH1G06MCUDSU P. 32
 JMXHH1G06MSUDSU P. 32
 JMXHH1G07FCUDSU P. 36
 JMXHH1G07FSUDSU P. 36
 JMXHH1G07MCUDSU P. 36
 JMXHH1G07MSUDSU P. 36
 JMXHH1G08FCUDSU P. 40
 JMXHH1G08FSUDSU P. 40
 JMXHH1G08MCUDSU P. 40
 JMXHH1G08MSUDSU P. 40
 JMXHH1G10FSUDSU P. 44
 JMXHH1G10MSUDSU P. 44
 JMXHH1G12FSUDSU P. 48
 JMXHH1G12MSUDSU P. 48

Overmolded cable assembly

HAOJMXFH1G02FCU100 P. 16
 HAOJMXFH1G02FCU200 P. 16
 HAOJMXFH1G02FCU300 P. 16
 HAOJMXFH1G02MCU100 P. 16
 HAOJMXFH1G02MCU200 P. 16
 HAOJMXFH1G02MCU300 P. 16
 HAOJMXFH1G03FCU100 P. 20
 HAOJMXFH1G03FCU200 P. 20
 HAOJMXFH1G03FCU300 P. 20
 HAOJMXFH1G03MCU100 P. 20
 HAOJMXFH1G03MCU200 P. 20
 HAOJMXFH1G03MCU300 P. 20
 HAOJMXFH1G04FCU100 P. 24
 HAOJMXFH1G04FCU200 P. 24
 HAOJMXFH1G04FCU300 P. 24
 HAOJMXFH1G04MCU100 P. 24
 HAOJMXFH1G04MCU200 P. 24
 HAOJMXFH1G04MCU300 P. 24
 HAOJMXFH1G05FCU100 P. 28
 HAOJMXFH1G05FCU200 P. 28
 HAOJMXFH1G05FCU300 P. 28
 HAOJMXFH1G05MCU100 P. 28
 HAOJMXFH1G05MCU200 P. 28
 HAOJMXFH1G05MCU300 P. 28
 HAOJMXFH1G06FCU100 P. 32
 HAOJMXFH1G06FCU200 P. 32
 HAOJMXFH1G06FCU300 P. 32
 HAOJMXFH1G06MCU100 P. 32
 HAOJMXFH1G06MCU200 P. 32
 HAOJMXFH1G06MCU300 P. 32
 HAOJMXFH1G07FCU100 P. 36
 HAOJMXFH1G07FCU200 P. 36
 HAOJMXFH1G07FCU300 P. 36
 HAOJMXFH1G07MCU100 P. 36
 HAOJMXFH1G07MCU200 P. 36
 HAOJMXFH1G07MCU300 P. 36
 HAOJMXFH1G08FCU100 P. 40
 HAOJMXFH1G08FCU200 P. 40
 HAOJMXFH1G08FCU300 P. 40
 HAOJMXFH1G08MCU100 P. 40
 HAOJMXFH1G08MCU200 P. 40
 HAOJMXFH1G08MCU300 P. 40
 HAOJMXFH1G10FSU100 P. 44
 HAOJMXFH1G10FSU200 P. 44
 HAOJMXFH1G10FSU300 P. 44
 HAOJMXFH1G10MSU100 P. 44
 HAOJMXFH1G10MSU200 P. 44
 HAOJMXFH1G10MSU300 P. 44
 HAOJMXFH1G12FSU100 P. 48
 HAOJMXFH1G12FSU200 P. 48
 HAOJMXFH1G12FSU300 P. 48
 HAOJMXFH1G12MSU100 P. 48
 HAOJMXFH1G12MSU200 P. 48
 HAOJMXFH1G12MSU300 P. 48

JBX1MPR P. 18
 JBX1MPV P. 18
 JBXBF1 P. 18
 JBXBR1 P. 18

Contacts

JBX1CTFC07 P. 56
 JBX1CTFC09 P. 56
 JBX1CTFC13 P. 56
 JBX1CTFS09 P. 55
 JBX1CTFS13 P. 55
 JBX1CTMC07 P. 56
 JBX1CTMC09 P. 56
 JBX1CTMC13 P. 56
 JBX1CTMS09 P. 55
 JBX1CTMS13 P. 55

Tooling

JBX1OUTLP07 P. 57
 JBX1OUTLP09 P. 57
 JBX1OUTLP13 P. 57
 JBX1OUTLS07 P. 57
 JBX1OUTLS09 P. 57
 JBX1OUTLS13 P. 57
 JBXOUTDCS07 P. 57
 JBXOUTDC09 P. 57
 JBXOUTDC13 P. 57
 M22520/7-01 P. 57

Accessories

JBX1MPA P. 18
 JBX1MPB P. 18
 JBX1MPG P. 18
 JBX1MPJ P. 18
 JBX1MPM P. 18
 JBX1MPN P. 18
 JBX1MPO P. 18

Notes

A large grid of graph paper for taking notes, consisting of 20 columns and 30 rows of small squares.

Reliable People, Reliable Solutions



Your local contact



Our contribution to environmental protection:
This catalog is printed on PEFC certified paper
Advancement of sustainable wood cultivation. www.pefc.org

www.esterline-connection-technologies.com
technical-emear-ect@esterline.com (Europe - Asia - Africa)
technical-americas-ect@esterline.com (North America)



SOURIAU