



# M2M MiMo LTE ANTENNA

## LOW PROFILE MiMo CELLULAR ANTENNA WITH OPTIONAL GPS/GNSS

The M2M MiMo LTE Antenna range has been designed to provide MiMo Cellular / LTE antenna function for IOT and M2M applications. The compact, robust low-profile housing is weatherproof and contains two antenna elements with effective isolation and correlation covering all current global cellular and LTE bands in freq. range 698-960/1710-3800MHz. The asset tracking version includes an active GPS/GNSS/Galileo/Beidou antenna for applications which require position or timing function.

The antenna can be fitted on a non-conductive panel if required\* and offers easy, quick, secure and weatherproof installation with the single hole mounting bush and acrylic adhesive sealing pad. Supplied with integrated 3m (10') cables and SMA plug connectors, the antenna will offer plug and play connectivity with many different terminals.

\*Performance may change depending on mounting position/surface.

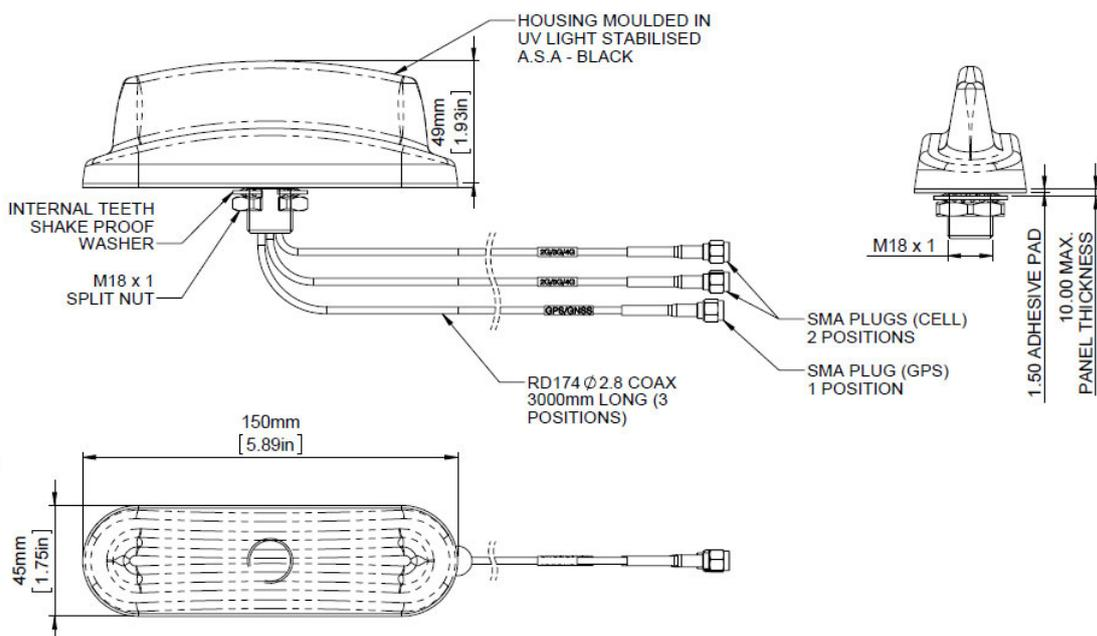

# M2M MiMo LTE/GPS ANTENNA

Low Profile MiMo Cellular Antenna with optional GPS/GNSS

## Typical VSWR - Elements 1 & 2\*

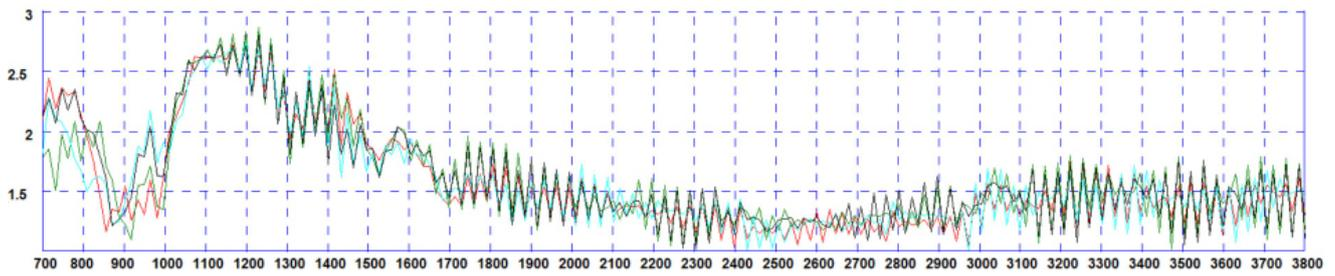

\* VSWR measured with 3m (10') of RG174 cable Green and Red plots = Elements 1 & 2 in free space Black and Blue plots = Elements 1 & 2 on a 400x400mm ground plane

## Typical Isolation - Elements 1 & 2\*

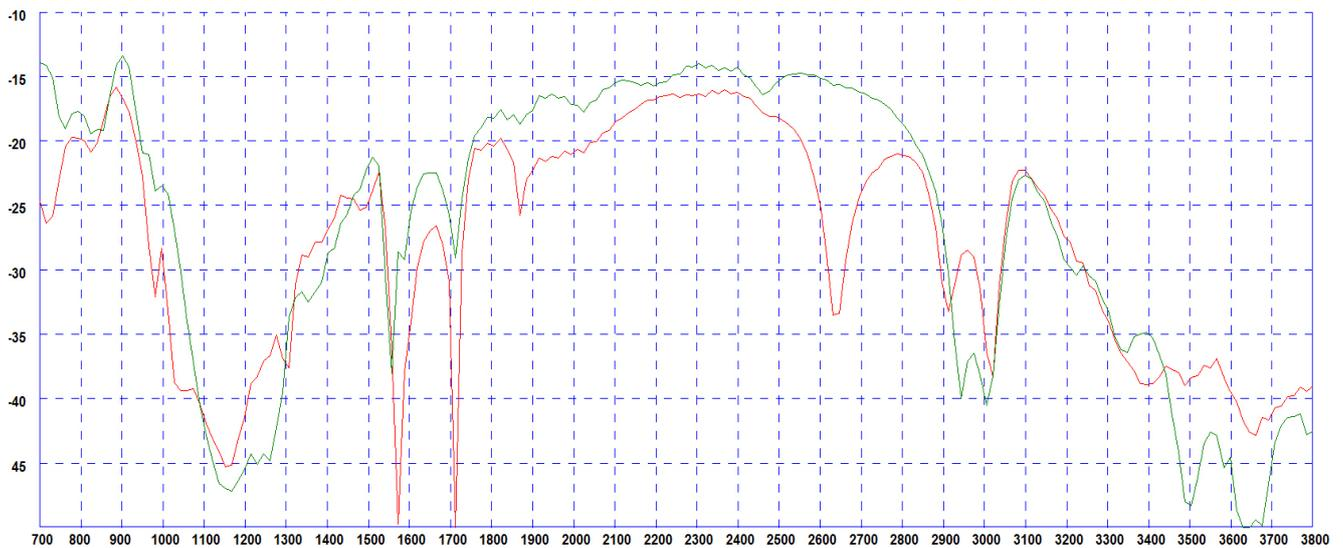

\* Isolation measured with 3m (10') of RG174 cable Red plot - mounted on a 400x400mm 1/4" x 1/4" ground plane Green plot - free space

## Typical Radiation Pattern - GPS/GNSS Element 3

Element 3: Typical E plane pattern 1602MHz

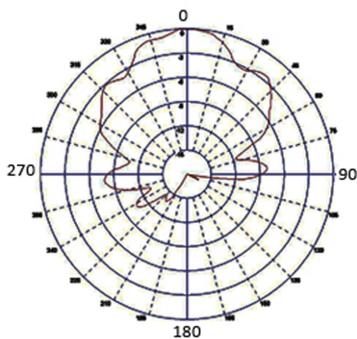

## Typical 3D Radiation Patterns - Cell / LTE Elements 1 & 2

3D Gain Plot Side (700MHz)



3D Gain Plot Top (700MHz)

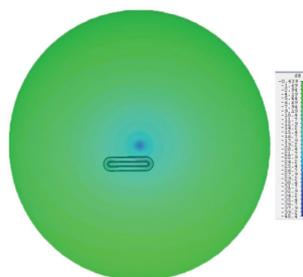

3D Gain Plot Side (800MHz)

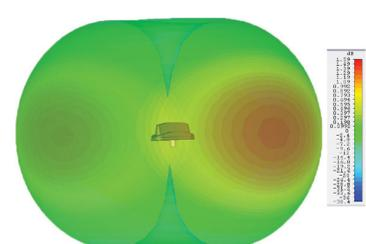

# M2M MiMo LTE/GPS ANTENNA

Low Profile MiMo Cellular Antenna with optional GPS/GNSS

3D Gain Plot Top (800MHz)

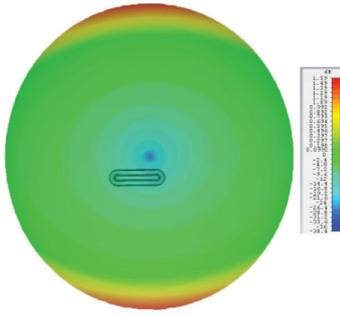

3D Gain Plot Side (900MHz)

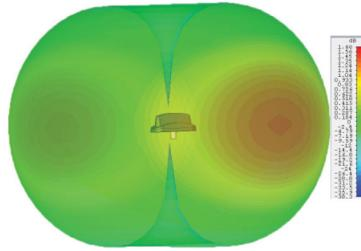

3D Gain Plot Top (900MHz)

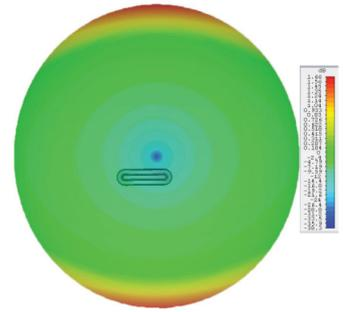

3D Gain Plot Side (1800MHz)

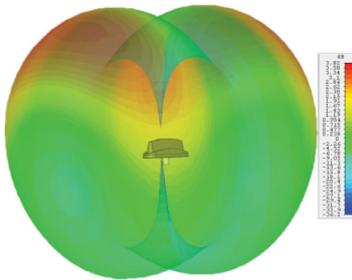

3D Gain Plot Top (1800MHz)

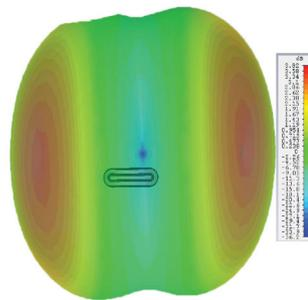

3D Gain Plot Side (2100MHz)

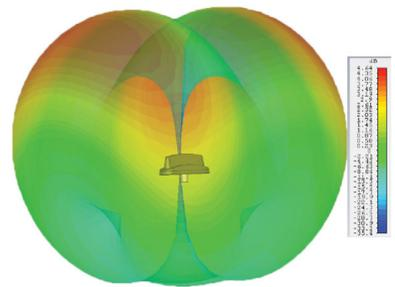

3D Gain Plot Top (2100MHz)

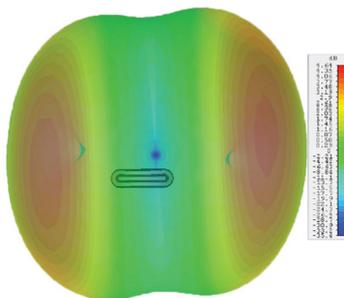

3D Gain Plot Side (2600MHz)

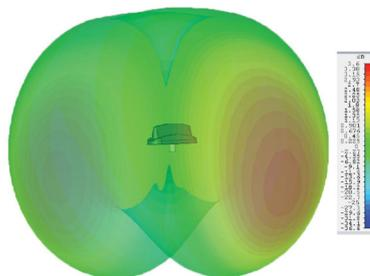

3D Gain Plot Top (2600MHz)

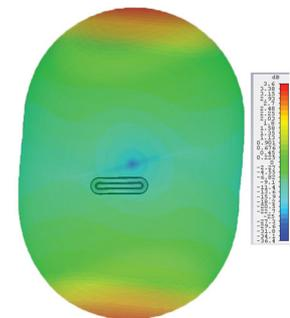

3D Gain Plot Side (3600MHz)

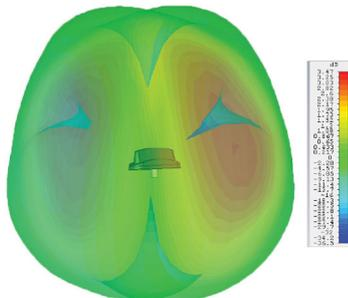

3D Gain Plot Top (3600MHz)

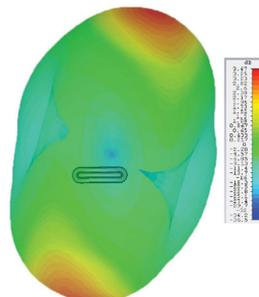

\* 3D radiation patterns simulated in CST Microwave Studio on a 600x600mm (2'x2') ground plane with both elements fed together.

# M2M MiMo LTE/GPS ANTENNA

Low Profile MiMo Cellular Antenna with optional GPS/GNSS

## Technical Information

Technical Information		Part Numbers	
		1-2309605-1	1-2309646-1
<b>Electrical Data</b>			
Frequency Range (MHz)	Elements 1 & 2	698-960 / 1710-3800MHz	
	Element 3	-	1562-1612MHz
Peak Gain Isotropic	Elements 1 & 2: 698-960MHz	1.5dBi	
	Elements 1 & 2: 1710-2700MHz	4.5dBi	
	Elements 1 & 2: 2500-3800MHz	5dBi	
Pattern	Omni-directional		
Nominal Impedance	50Ω		
Max input power (W)	20		
<b>GPS/GNSS Data</b>			
Frequency Range (MHz)	-	1562-1612MHZ	
LNA Gain	-	26	
Polarisation	-	Right Hand Circular	
Operating Voltage	-	3-5VDC (Fed via Coax)	
Current	-	Typical <20mA	
<b>Mechanical Data</b>			
Dimensions (mm)	Height	49 (1.9")	
	Length	150 (5.90")	
	Width	45 (1.77")	
Operating Temp (°C)	-30 to +70 (-30°F to 158°F)		
Material	UV Stable ABS Plastic		
Colour	Black		
Typical Weight (g)	337		
<b>Mounting Data</b>			
Fixing	18mm (3/4") mounting bush and acrylic adhesive pad		
<b>Cable Data</b>			
Elements 1 & 2: Cell / LTE	Cable Type	RG174	
	Diameter (mm)	2.8 (0.1")	
	Length (m)	3 (9.8')	
	Termination	2x SMA Plugs	
Element 3: GPS/GNSS	Cable Type	-	RG174
	Diameter (mm)	-	2.8 (0.1")
	Length (m)	-	3 (9.8')
	Termination	-	SMA Plug