

Spezifikation für Freigabe / specification for release

Kunde / customer :

Artikelnummer / part number :

744273102

Bezeichnung : **STROMKOMP. DROSSEL WE-SL5 HC**

description : **COMMON MODE CHOKE WE-SL5 HC**



DATUM / DATE : 2010-07-15

A Mechanische Abmessungen / Dimensions:

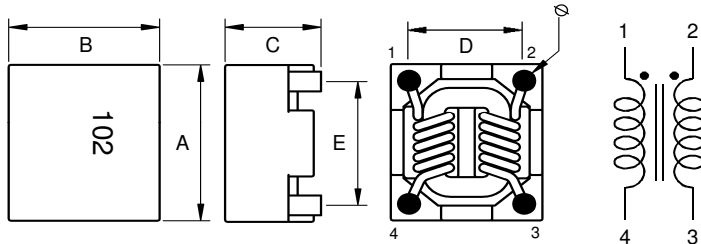

A	9,5 max.	mm
B	8,3 max.	mm
C	5,3 max.	mm
D	6,3 ± 0,1	mm
E	7,5 ± 0,1	mm
Ø	1,2 typ.	mm

B Elektrische Eigenschaften / Electrical Properties:

Eigenschaften / properties	Testbedingungen / test conditions		Wert / value	Einheit / unit	tol.
Gleichtaktimpedanz / Common mode impedance	@ 100 MHz	Z	1000	Ω	±25%
Leerlauf-Induktivität / inductance	100 kHz / 0,1 mA / 20 °C	L _O	11,00	μH	typ.
DC-Widerstand / DC-resistance	@ 20 °C	R _{DC}	30,0	mΩ	max.
Nennstrom / rated current	ΔT = 40 K	I _N	2,5	A	max.
Nennspannung / rated voltage	DC/AC	U _N	80/42	V	max.

C Lötpad / Land Pattern:

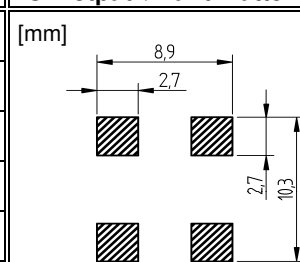

D Prüfgeräte / test equipment:

WAYNE KERR WK3260B/WK3265 für/for L₀ und/and R_{0c}

HP 34401 A für/for I_N

E Testbedingungen / test conditions:

Luftfeuchtigkeit / humidity:	33%
Umgebungstemperatur / temperature:	20 °C
Prüfspannung / isolation voltage	500V, 50Hz

F Werkstoffe & Zulassungen / material & approvals:

Gehäuse / case:	UL94 V-0
Draht / wire:	P155 IEC317-20
Kern / core	NiZn-Ferrit / NiZn ferrite

G Eigenschaften / general specifications:

Klimabeständigkeit/ climatic class:	40/125/21
Betriebstemp. / operating temperature:	- 40 °C - +125 °C

It is recommended that the temperature of the part does not exceed 125 °C under worst case operating conditions.

Freigabe erteilt / general release:	Kunde / customer	
Datum / date	Unterschrift / signature	
	Würth Elektronik	
Geprüft / checked	Kontrolliert / approved	
	SBa	Version 1
	Name	Änderung / modification
		Datum / date

This electronic component has been designed and developed for usage in general electronic equipment. Before incorporating this component into any equipment where higher safety and reliability is especially required or if there is the possibility of direct damage or injury to human body, for example in the range of aerospace, aviation, nuclear control, submarine, transportation, (automotive control, train control, ship control), transportation signal, disaster prevention, medical, public information network etc, Würth Elektronik eiSos GmbH must be informed before the design-in stage. In addition, sufficient reliability evaluation checks for safety must be performed on every electronic component which is used in electrical circuits that require high safety and reliability functions or performance.

Würth Elektronik eiSos GmbH & Co. KG

D-74638 Waldenburg · Max-Eyth-Strasse 1 - 3 · Germany · Telefon (+49) (0) 7942 - 945 - 0 · Telefax (+49) (0) 7942 - 945 - 400
http://www.we-online.com

Spezifikation für Freigabe / specification for release

Kunde / customer :

Artikelnummer / part number : **744273102**

Bezeichnung : **STROMKOMP. DROSSEL WE-SL5 HC**

description : **COMMON MODE CHOKE WE-SL5 HC**



DATUM / DATE : 2010-07-15

H Impedanz / impedance:

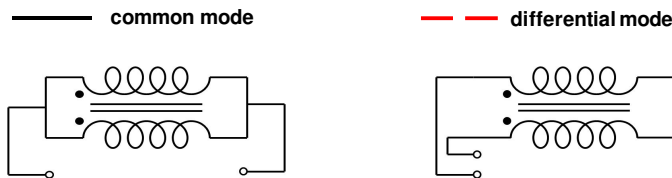
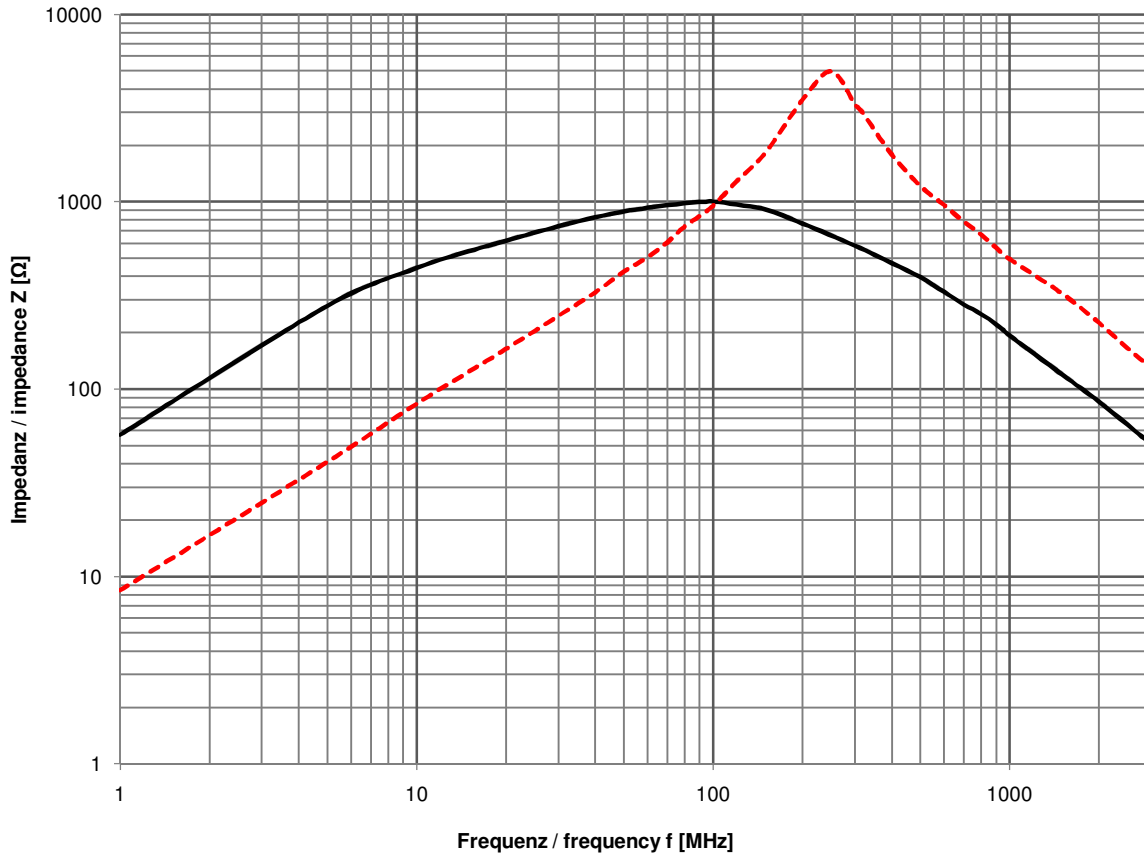

Freigabe erteilt / general release:	Kunde / customer			
.....			
Datum / date	Unterschrift / signature			
	Würth Elektronik			
.....			
Geprüft / checked	Kontrolliert / approved	SBa	Version 1	2010-07-15
		Name	Änderung / modification	Datum / date

This electronic component has been designed and developed for usage in general electronic equipment. Before incorporating this component into any equipment where higher safety and reliability is especially required or if there is the possibility of direct damage or injury to human body, for example in the range of aerospace, aviation, nuclear control, submarine, transportation, (automotive control, train control, ship control), transportation signal, disaster prevention, medical, public information network etc, Würth Elektronik eiSos GmbH must be informed before the design-in stage. In addition, sufficient reliability evaluation checks for safety must be performed on every electronic component which is used in electrical circuits that require high safety and reliability functions or performance.

Würth Elektronik eiSos GmbH & Co. KG

D-74638 Waldenburg · Max-Eyth-Strasse 1 - 3 · Germany · Telefon (+49) (0) 7942 - 945 - 0 · Telefax (+49) (0) 7942 - 945 - 400
<http://www.we-online.com>

Spezifikation für Freigabe / specification for release

Kunde / customer :

Artikelnummer / part number : **744273102**

Bezeichnung : **STROMKOMP. DROSSEL WE-SL5 HC**

description : **COMMON MODE CHOKE WE-SL5 HC**



DATUM / DATE : 2010-07-15

I Rollenspezifikation / tape and reel specification:

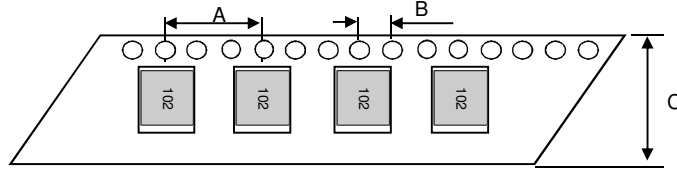

Gurtspezifikation / Tape specification:		
A	12	mm
B	4	mm
C	24	mm

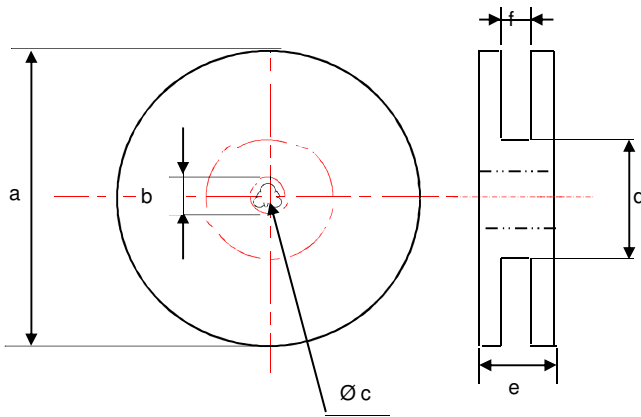

Rollenspezifikation / Reel specification:		
a	330 ± 2,0	mm
b	21 ± 0,8	mm
c	13 ± 0,5	mm
d	50 ± 1,0	mm
e	20,5	mm
f	17	mm

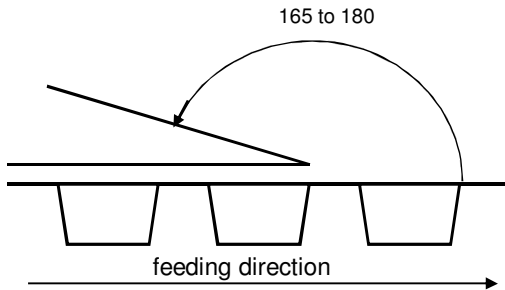

The force for tearing off cover tape is 10 to 130 grams in arrow direction

Freigabe erteilt / general release:	Kunde / customer			
Datum / date	Unterschrift / signature			
	Würth Elektronik			
Geprüft / checked	Kontrolliert / approved	SBa	Version 1	2010-07-15
		Name	Änderung / modification	Datum / date

This electronic component has been designed and developed for usage in general electronic equipment. Before incorporating this component into any equipment where higher safety and reliability is especially required or if there is the possibility of direct damage or injury to human body, for example in the range of aerospace, aviation, nuclear control, submarine, transportation, (automotive control, train control, ship control), transportation signal, disaster prevention, medical, public information network etc. Würth Elektronik eiSos GmbH must be informed before the design-in stage. In addition, sufficient reliability evaluation checks for safety must be performed on every electronic component which is used in electrical circuits that require high safety and reliability functions or performance.

Würth Elektronik eiSos GmbH & Co. KG

D-74638 Waldenburg · Max-Eyth-Strasse 1 · 3 · Germany · Telefon (+49) (0) 7942 - 945 - 0 · Telefax (+49) (0) 7942 - 945 - 400
<http://www.we-online.com>