

LK series Keylock Switches

Distinctive features and specifications

LK_U1605US



- Single and double pole options
- Up to four positions
- Momentary and maintained switching
- Multiple key pull position options
- 45° or 90° indexing

ELECTRICAL SPECIFICATIONS

- Contact rating : 4A at 125 VAC or 28VDC, 2A at 250 VAC
- Contact resistance : $\leq 10 \text{ m}\Omega$
- Insulation resistance : $\geq 109 \text{ M}\Omega$
- Dielectric strength : 1000 V RMS minimum at sea level
- Electrical life : 6000 cycles at full load

GENERAL SPECIFICATIONS

- Mechanical life : 6000 cycles at full load.
- Operating temperature range : -30°C to $+85^\circ\text{C}$

MATERIALS

- Lock housing : Zinc alloy die casted, nickel plated
- Cylinder : 4 disc tumbler, zinc alloy die casted, nickel plated
- Keys : 2 single bitted keys, brass nickel plated
- Contacts : Gold plated copper alloy
- Body : Glass filled polyester

AGENCY APPROVALS



UL recognised



Dimensions : first dimensions are in mm while inches are shown in brackets.
Refer to the following pages for further information.



Mounting accessories : Standard hardware supplied : 1 nut.
For spare keys please contact APEM.



Packaging unit : 25

LK series

Keylock Switches

Overview

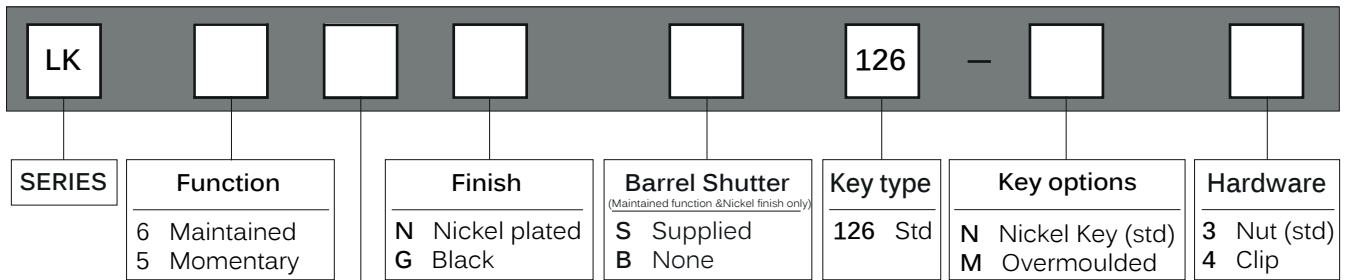

	Maintained function	No of Poles	Lock Configuration	Indexing	Terminals Connected				Key Pull Position
					Pos. 1	Pos. 2	Pos. 3	Pos. 4	
A	SP			45°	8-1	1-2	2-3	—	1
B (std)	DP				8-1, 4-5	1-2, 5-6	2-3, 6-7	—	
C	SP			45°	8-1	1-2	2-3	—	3
D (std)	DP				8-1, 4-5	1-2, 5-6	2-3, 6-7	—	
E	SP			45°	8-1	1-2	2-3	—	1 & 3
F (std)	DP				8-1, 4-5	1-2, 5-6	2-3, 6-7	—	
G	SP			45°	8-1	1-2	7-8	—	1
H (std)	DP				8-1, 4-5	1-2, 5-6	7-8, 3-4	—	
7	SP			45°	8-1	1-2	7-8	—	1, 2 & 3
J (std)	DP				8-1, 4-5	1-2, 5-6	7-8, 3-4	—	
N	SP			90°	8-1	1-3	—	—	1
8 (std)	DP				8-1, 4-5	1-3, 5-7	—	—	
P	SP			90°	8-1	1-3	—	—	2
Q (std)	DP				8-1, 4-5	1-3, 5-7	—	—	
R	SP			90°	8-1	1-3	—	—	1 & 2
S (std)	DP				8-1, 4-5	1-3, 5-7	—	—	
9	DP			45°	8-1	1-2	2-3	3-4	1, 2, 3 & 4

	Momentary function	No of Poles	Lock Configuration	Indexing	Terminals Connected				Key Pull Position
					Pos. 1	Pos. 2	Pos. 3	Pos. 4	
A (std)	SP			45°	8-1	1-2	—	—	1
B	DP				8-1, 1-2	1-2, 5-6	—	—	
E (std)	SP			45°	8-1	1-2	7-8	—	1
F	DP				8-1, 4-5	1-2, 5-6	7-8, 3-4	—	
G	SP			45°/90°	7-1	1-2	6-7	—	1 & 3
7 (std)	SP			45°	8-1	1-2	7-8	—	1
J	DP				8-1, 4-5	1-2, 5-6	7-8, 3-4	—	

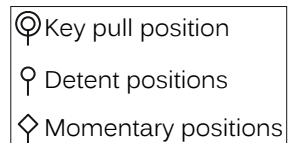

LK series Keylock Switches

Panel cut-out Ø19 (0.755)

MODEL
STRUCTURE



- 2, 3 and 4 position configuration
- Maintained and momentary functions
- Standard and overmoulded key
- Nut or clip fixing
- Barrel shutter option

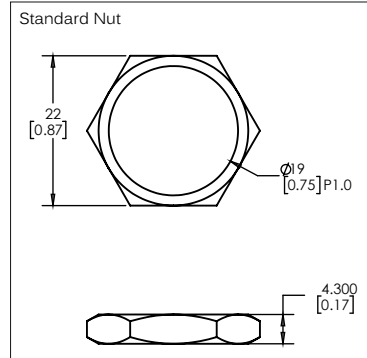
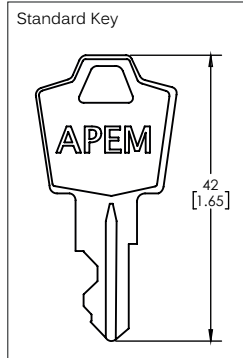
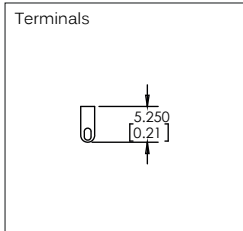
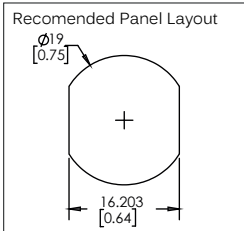

Maintained

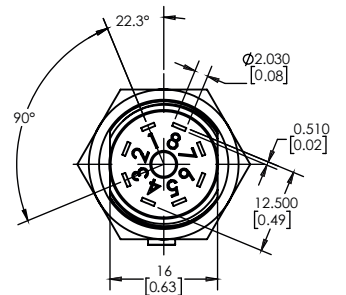
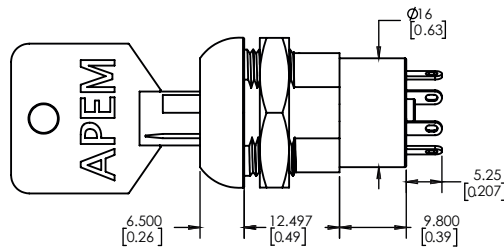
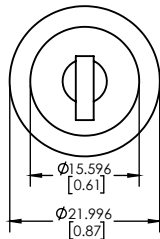

Momentary

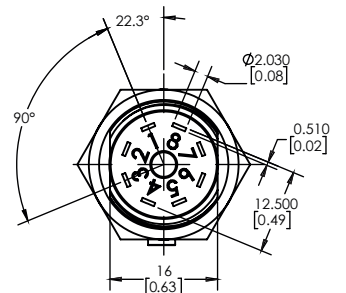
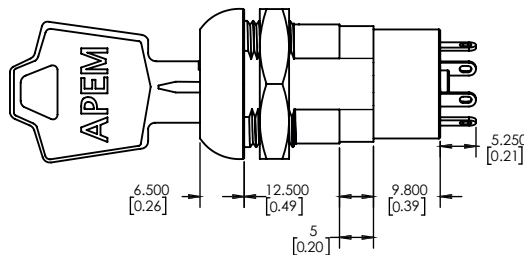
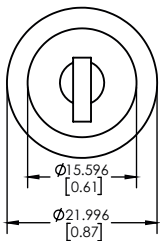

OPTIONS

Overmoulded Key

