

R88M-1□

# 1S servo motor

## Simplified machine design and maintenance

- 23-bit resolution encoder
- Compact and small motor size
- Multi-turn encoder design without mechanics: 16-bit, 65536 turns
- Battery-free absolute multi-turn encoder
- Pre-assembled motor cables
- Designed for easy EMC compliance

## Ratings

- 230 VAC from 100 W to 1.5 kW  
(rated torque from 0.318 to 8.59 Nm)
- 400 VAC from 400 W to 3 kW  
(rated torque from 1.91 to 28.7 Nm)



## System configuration

(Refer to servo drive chapter)

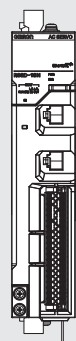

1S servo drive

### 1S servo motor (Flange size 80 mm or less)

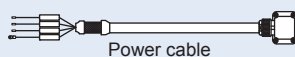

Power cable

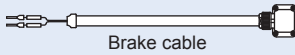

Brake cable

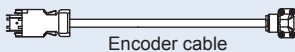

Encoder cable

**SYSMAC**  
always in control

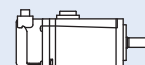

3000 rpm (100 W - 750 W)

### 1S servo motor (Flange size 100 mm or more)

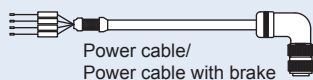

Power cable/  
Power cable with brake

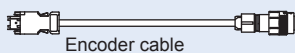

Encoder cable

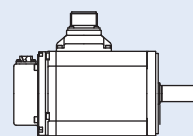

3000 rpm (1 kW - 3 kW)  
2000 rpm (400 W - 3 kW)  
1000 rpm (900 W - 3 kW)

## Servo motor / Servo drive combination

1S servo motor						1S servo drive		
Appearance	Speed	Voltage	Rated torque	Capacity	Model			
	3000 min <sup>-1</sup>	230 V	0.318 Nm	100 W	R88M-1M10030T-□	R88D-1SN01H-ECT		
			0.637 Nm	200 W	R88M-1M20030T-□	R88D-1SN02H-ECT		
			1.27 Nm	400 W	R88M-1M40030T-□	R88D-1SN04H-ECT		
			2.39 Nm	750 W	R88M-1M75030T-□	R88D-1SN08H-ECT		
			3.18 Nm	1 kW	R88M-1L1K030T-□	R88D-1SN15H-ECT		
			4.77 Nm	1.5 kW	R88M-1L1K530T-□	R88D-1SN15H-ECT		
		400 V	2.39 Nm	750 W	R88M-1L75030C-□	R88D-1SN10F-ECT		
			3.18 Nm	1 kW	R88M-1L1K030C-□	R88D-1SN10F-ECT		
			4.77 Nm	1.5 kW	R88M-1L1K530C-□	R88D-1SN15F-ECT		
			6.37 Nm	2 kW	R88M-1L2K030C-□	R88D-1SN20F-ECT		
	2000 min <sup>-1</sup>	230 V	4.77 Nm	1 kW	R88M-1M1K020T-□	R88D-1SN15H-ECT		
			7.16 Nm	1.5 kW	R88M-1M1K520T-□	R88D-1SN15H-ECT		
		400 V	1.91 Nm	400 W	R88M-1M40020C-□	R88D-1SN06F-ECT		
			2.86 Nm	600 W	R88M-1M60020C-□	R88D-1SN06F-ECT		
			4.77 Nm	1 kW	R88M-1M1K020C-□	R88D-1SN10F-ECT		
			7.16 Nm	1.5 kW	R88M-1M1K520C-□	R88D-1SN15F-ECT		
			9.55 Nm	2 kW	R88M-1M2K020C-□	R88D-1SN20F-ECT		
			14.3 Nm	3 kW	R88M-1M3K020C-□	R88D-1SN30F-ECT		
			1000 min <sup>-1</sup>	230 V	8.59 Nm	900 W	R88M-1M90010T-□	R88D-1SN15H-ECT
					8.59 Nm	900 W	R88M-1M90010C-□	R88D-1SN10F-ECT
400 V	19.1 Nm	2 kW	R88M-1M2K010C-□	R88D-1SN20F-ECT				
	28.7 Nm	3 kW	R88M-1M3K010C-□	R88D-1SN30F-ECT				

**Note:** For servo motor and cable part numbers, refer to ordering information at the end of this chapter.

**Note:** Refer to the servo drive chapter for drive options selection and detailed specifications.

## Type designation

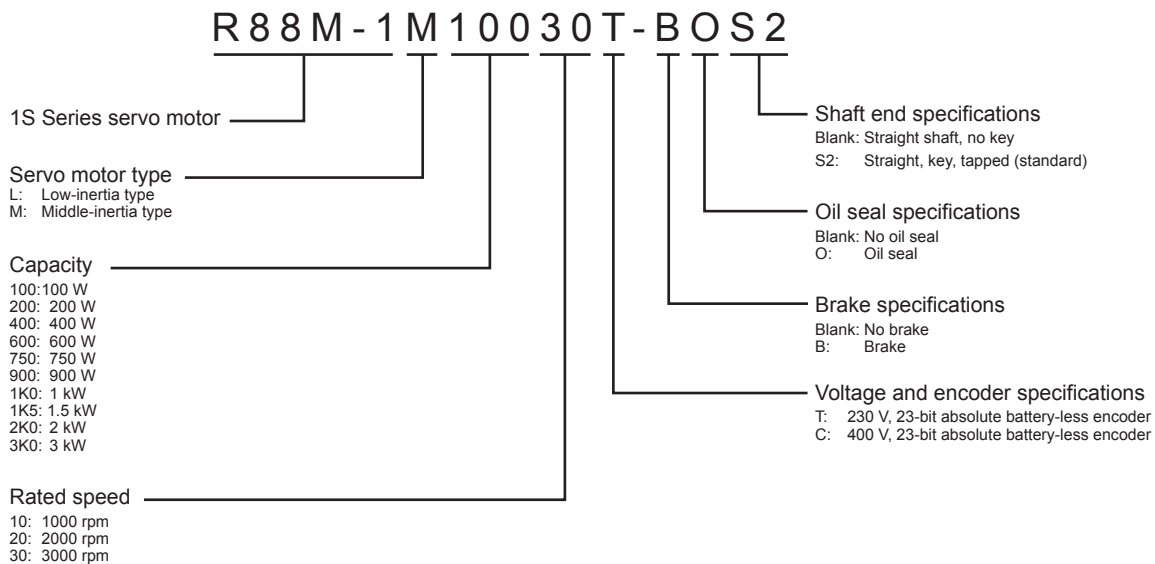

Specifications

3000 r/min servo motors, 230 V

Ratings and specifications

Voltage		230 V					
Servo motor model: R88M-1□	23-bit absolute encoder	M10030T-□	M20030T-□	M40030T-□	M75030T-□	L1K030T-□	L1K530T-□
Rated output	W	100	200	400	750	1000	1500
Rated torque	Nm	0.318	0.637	1.27	2.39	3.18	4.77
Instantaneous peak torque	Nm	1.11	2.2	4.5	8.4	9.55	14.3
Rated current	A (rms)	0.84	1.5	2.5	4.6	5.2	8.8
Instantaneous max. current	A (rms)	3.1	5.6	9.1	16.9	16.9	28.4
Rated speed	min <sup>-1</sup>	3000					
Max. speed	min <sup>-1</sup>	6000				5000	
Torque constant	N·m/A	0.42	0.48	0.56	0.59	0.67	0.58
Rotor moment of inertia	kg·m <sup>2</sup> ×10 <sup>-4</sup> (without brake)	0.089	0.2232	0.4452	1.8242	2.1042	2.1042
	kg·m <sup>2</sup> ×10 <sup>-4</sup> (with brake)	0.0968	0.2832	0.5052	2.0742	2.5542	2.5542
Electrical time constant	ms	0.83	2.4	2.6	3.3	5.9	6.1
Allowable radial load	N	68	245		490		
Allowable thrust load	N	58	88		196		
Weight	kg (without brake)	0.52	1.0	1.4	2.9	5.7	
	kg (with brake)	0.77	1.3	1.9	3.9	7.4	
Brake specifications	Excitation voltage* <sup>1</sup>	24 VDC ±10%					
	Holding brake moment of inertia J	kg·m <sup>2</sup> ×10 <sup>-4</sup>	0.0078	0.06		0.25	0.45
	Current consumption (at 20°C)	A	0.27	0.32		0.37	0.70
	Static friction torque	Nm (minimum)	0.32	1.37		2.55	9.3
Basic specifications	Insulation class	Type F					
	Ambient operating/storage temperature	0 to 40°C/-20 to 65°C					
	Ambient operating/storage humidity	20 to 90% (non-condensing)					
	Atmosphere	No corrosive gases					
	Insulation resistance	10 MΩ min. at 500 VDC between the power terminals and FG terminal					
	Vibration resistance	Vibration acceleration of 49 m/s <sup>2</sup>					
	Impact resistance	Acceleration of 98 m/s <sup>2</sup> max. 3 times each in X, Y and Z directions					
Enclosure	IP67 (except for through-shaft parts when connectors are inserted)						

\*<sup>1</sup> This is a non-excitabile brake (it is released when excitation voltage is applied).

Torque-speed characteristics

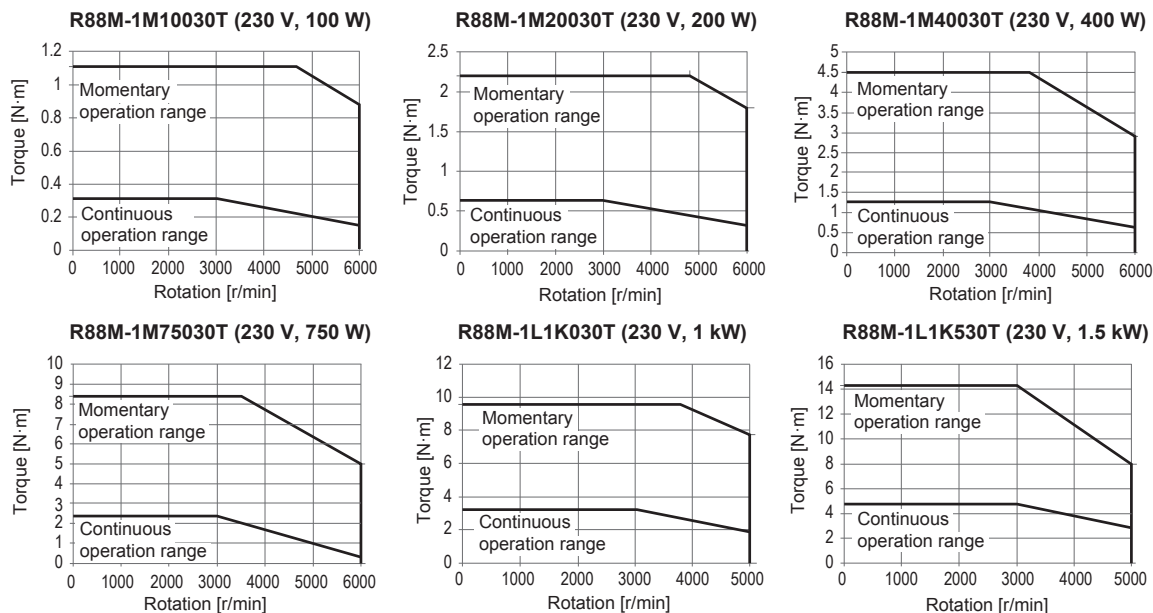

## 3000 r/min servo motors, 400 V

### Ratings and specifications

Voltage		400 V				
Servo motor model: R88M-1□	23-bit absolute encoder	L75030C-□	L1K030C-□	L1K530C-□	L2K030C-□	L3K030C-□
Rated output	W	750	1000	1500	2000	3000
Rated torque	Nm	2.39	3.18	4.77	6.37	9.55
Instantaneous peak torque	Nm	7.16	9.55	14.3	19.1	28.7
Rated current	A (rms)	3.0	3.0	4.5	6.3	8.2
Instantaneous max. current	A (rms)	9.6	9.6	14.1	19.8	27.7
Rated speed	min <sup>-1</sup>	3000				
Max. speed	min <sup>-1</sup>	5000				
Torque constant	N·m/A	0.91	1.17	1.17	1.15	1.23
Rotor moment of inertia	kg·m <sup>2</sup> ×10 <sup>-4</sup> (without brake)	1.3042	2.1042	2.1042	2.4042	6.8122
	kg·m <sup>2</sup> ×10 <sup>-4</sup> (with brake)	1.7542	2.5542	2.5542	2.8542	7.3122
Electrical time constant	ms	4.3	5.9	5.9	6.3	11.0
Allowable radial load	N	490				
Allowable thrust load	N	196				
Weight	kg (without brake)	4.1	5.7		6.4	11.5
	kg (with brake)	5.8	7.4		8.1	12.5
Brake specifications	Excitation voltage* <sup>1</sup>	24 VDC ±10%				
	Holding brake moment of inertia J	0.45				0.50
	Current consumption (at 20°C)	0.70				0.66
	Static friction torque	9.3				12.0
Basic specifications	Insulation class	Type F				
	Ambient operating/storage temperature	0 to 40°C/-20 to 65°C				
	Ambient operating/storage humidity	20 to 90% (non-condensing)				
	Atmosphere	No corrosive gases				
	Insulation resistance	10 MΩ min. at 500 VDC between the power terminals and FG terminal				
	Vibration resistance	Vibration acceleration of 49 m/s <sup>2</sup>				
	Impact resistance	Acceleration of 98 m/s <sup>2</sup> max. 3 times each in X, Y and Z directions				
	Enclosure	IP67 (except for through-shaft parts when connectors are inserted)				

\*<sup>1</sup> This is a non-excitabile brake (it is released when excitation voltage is applied).

### Torque-speed characteristics

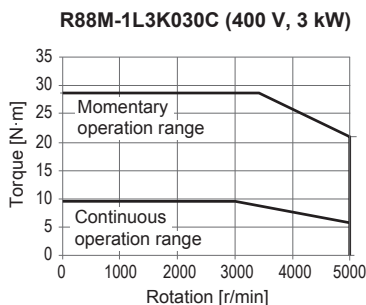
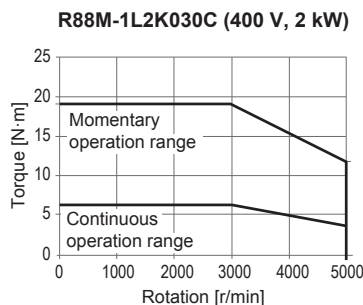
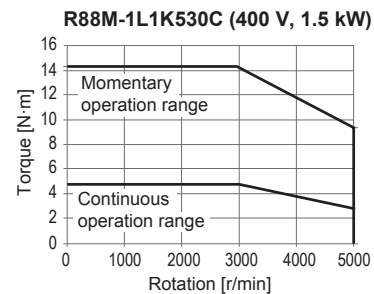
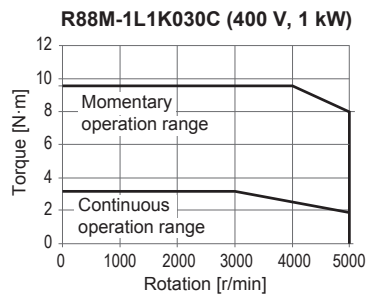
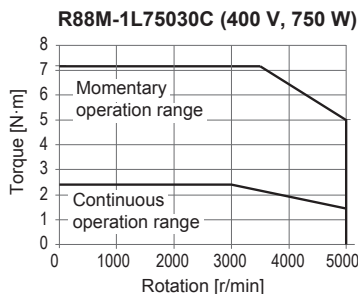

2000 r/min servo motors, 230 V/400 V

Ratings and specifications

Voltage		230 V			400 V					
Servo motor model: R88M-1□	23-bit absolute encoder	M1K020T-□	M1K520T-□	M40020C-□	M60020C-□	M1K020C-□	M1K520C-□	M2K020C-□	M3K020C-□	
Rated output	W	1000	1500	400	600	1000	1500	2000	3000	
Rated torque	Nm	4.77	7.16	1.91	2.86	4.77	7.16	9.55	14.3	
Instantaneous peak torque	Nm	14.3	21.5	5.73	8.59	14.3	21.5	28.7	43.0	
Rated current	A (rms)	5.2	8.6	1.1	1.6	2.9	4.1	5.7	8.6	
Instantaneous max. current	A (rms)	16.9	28.4	3.9	5.5	9.4	13.5	19.8	28.3	
Rated speed	min <sup>-1</sup>	2000								
Max. speed	min <sup>-1</sup>	3000								
Torque constant	N·m/A	0.93	0.83	1.75	1.84	1.69	1.75	1.75	1.74	
Rotor moment of inertia	kg·m <sup>2</sup> ×10 <sup>-4</sup> (without brake)	6.0042	9.0042	2.5042	3.9042	6.0042	9.0042	12.2042	15.3122	
	kg·m <sup>2</sup> ×10 <sup>-4</sup> (with brake)	6.5042	9.5042	2.8472	4.2472	6.5042	9.5042	12.7042	17.4122	
Electrical time constant	ms	13.0	15.0	6.8	7.8	13.0	13.0	14.0	20.0	
Allowable radial load	N	490							784	
Allowable thrust load	N	196							343	
Weight	kg (without brake)	6.6	8.5	3.9	4.7	6.6	8.5	10.0	12.0	
	kg (with brake)	8.6	10.5	4.8	5.8	8.6	10.5	12.0	15.0	
Brake specifications	Excitation voltage <sup>*1</sup>	24 VDC ±10%								
	Holding brake moment of inertia J	kg·m <sup>2</sup> ×10 <sup>-4</sup> 0.5			0.343		0.5		2.1	
	Current consumption (at 20°C)	A 0.51		0.3			0.51		0.66	
	Static friction torque	Nm (minimum) 9.0			3.92			9.0		12.0
Basic specifications	Insulation class	Type F								
	Ambient operating/storage temperature	0 to 40°C/-20 to 65°C								
	Ambient operating/storage humidity	20 to 90% (non-condensing)								
	Atmosphere	No corrosive gases								
	Insulation resistance	10 MΩ min. at 500 VDC between the power terminals and FG terminal								
	Vibration resistance	Vibration acceleration of 49 m/s <sup>2</sup>								
	Impact resistance	Acceleration of 98 m/s <sup>2</sup> max. 3 times each in X, Y and Z directions								
Enclosure	IP67 (except for through-shaft parts when connectors are inserted)									

\*1 This is a non-excitabile brake (it is released when excitation voltage is applied).

Torque-speed characteristics

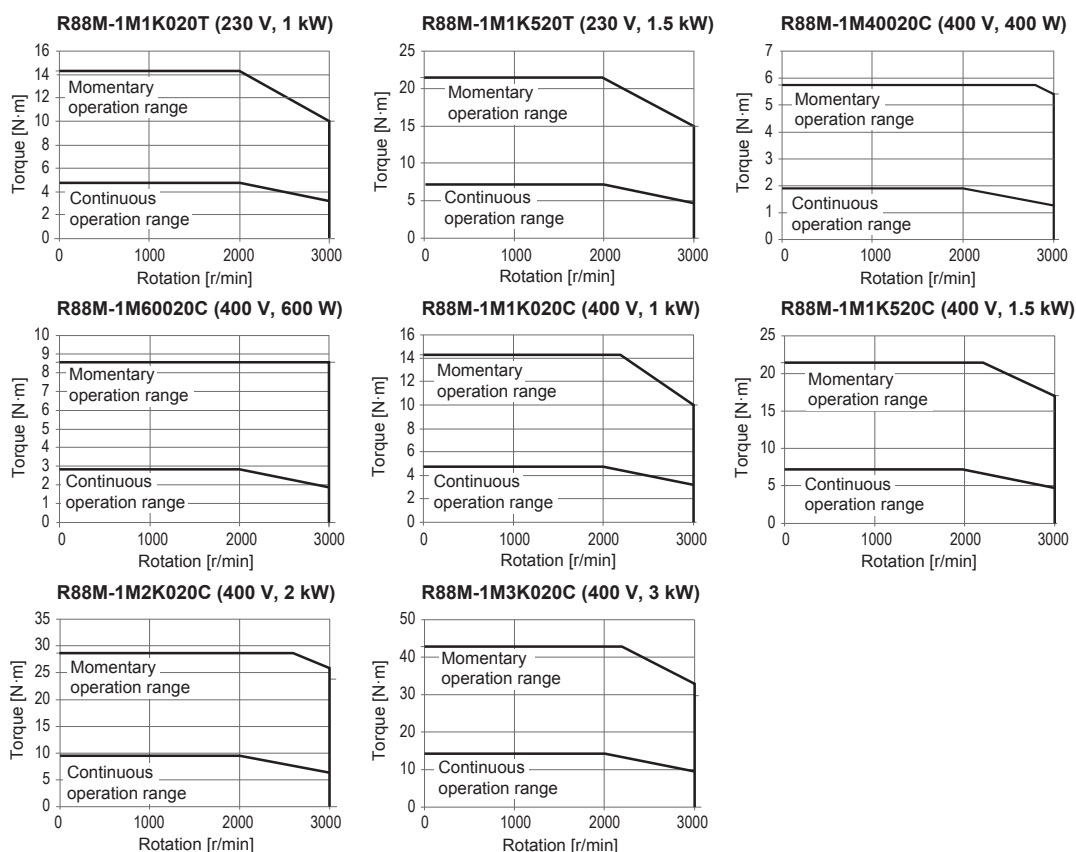

## 1000 r/min servo motors, 230 V/400 V

### Ratings and specifications

Voltage		230 V	400 V		
Servo motor model: R88M-1□	23-bit absolute encoder	M90010T-□	M90010C-□	M2K010C-□	M3K010C-□
Rated output	W	900	900	2000	3000
Rated torque	Nm	8.59	8.59	19.1	28.7
Instantaneous peak torque	Nm	19.3	19.3	47.7	71.7
Rated current	A (rms)	6.7	3.6	7.1	10.6
Instantaneous max. current	A (rms)	16.9	9.0	19.5	27.7
Rated speed	min <sup>-1</sup>	1000			
Max. speed	min <sup>-1</sup>	2000			
Torque constant	N·m/A	1.28	2.41	3.00	2.97
Rotor moment of inertia	kg·m <sup>2</sup> ×10 <sup>-4</sup> (without brake)	9.0042	9.0042	40.0122	68.0122
	kg·m <sup>2</sup> ×10 <sup>-4</sup> (with brake)	9.5042	9.5042	45.1122	73.1122
Electrical time constant	ms	15.0	13.0	16.0	19.0
Allowable radial load	N	686		1176	1470
Allowable thrust load	N	196		490	
Weight	kg (without brake)	8.5		18.0	28.0
	kg (with brake)	10.5		22.0	33.0
Brake specifications	Excitation voltage* <sup>1</sup>	24 VDC ±10%			
	Holding brake moment of inertia J	kg·m <sup>2</sup> ×10 <sup>-4</sup>	0.5	5.1	
	Current consumption (at 20°C)	A	0.51	1.2	1.0
	Static friction torque	Nm (minimum)	9.0	22.0	42.0
Basic specifications	Insulation class	Type F			
	Ambient operating/storage temperature	0 to 40°C/-20 to 65°C			
	Ambient operating/storage humidity	20 to 90% (non-condensing)			
	Atmosphere	No corrosive gases			
	Insulation resistance	10 MΩ min. at 500 VDC between the power terminals and FG terminal			
	Vibration resistance	Vibration acceleration of 49 m/s <sup>2</sup>			
	Impact resistance	Acceleration of 98 m/s <sup>2</sup> max. 3 times each in X, Y and Z directions			
	Enclosure	IP67 (except for through-shaft parts when connectors are inserted)			

\*<sup>1</sup> This is a non-excitable brake (it is released when excitation voltage is applied).

### Torque-speed characteristics

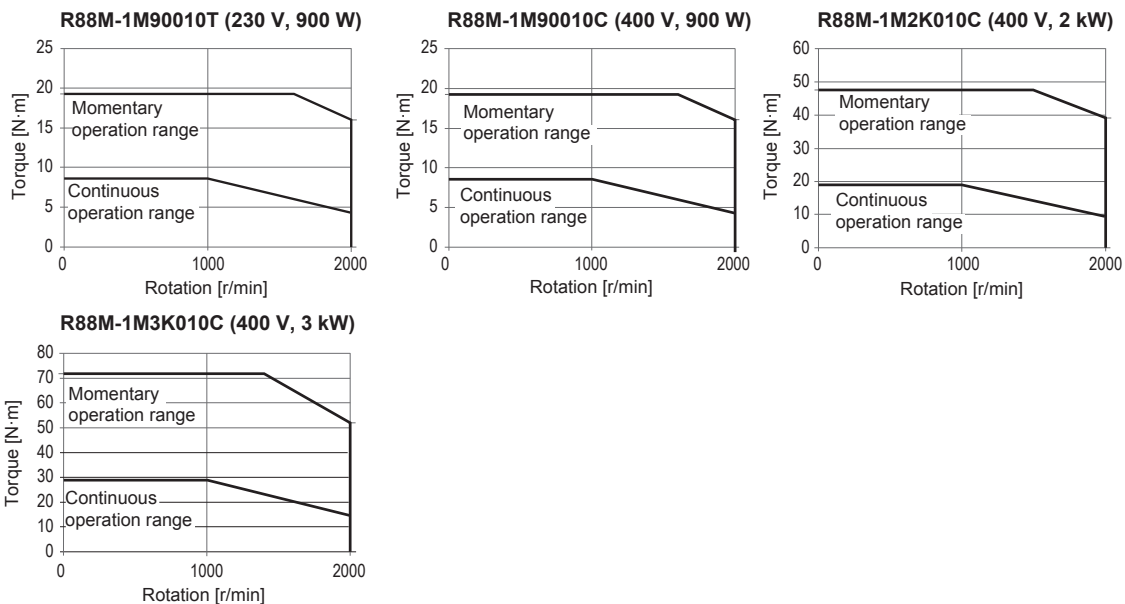

Dimensions

Servo motors

Type 3000 r/min motors (230 V, 100 W)

Dimensions (mm)	Without brake	With brake	Approx. mass (kg)	
Model: R88M-1□	LL	LL	Without brake	With brake
M10030T-□S2	90	126	0.52	0.77

Models without brake

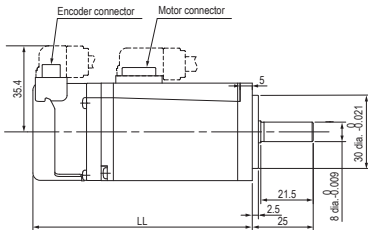

Models with brake

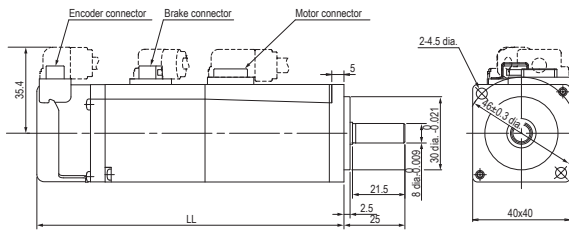

Shaft end

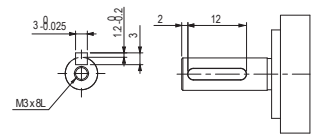

Type 3000 r/min motors (230 V, 200 W to 750 W)

Dimensions (mm)	Without brake		With brake		LR	Flange surface					Shaft end						Approx. mass (kg)		
	LL	KL1	LL	KL1		LB	LC	LD	LG	LZ	S	QA	QK	W	U	T	Tap x depth	Without brake	With brake
Model: R88M-1□																			
M20030T-□S2	79.5	44.6	107.5	44.6	30	50 dia. 0-0.025	60	70	6	4.5	11 dia. 0-0.011	2	20	4 0-0.03	1.5 0-0.2	4	M4 x 10L	1.0	1.3
M40030T-□S2	105.5		133.5								14 dia. 0-0.011			5 0-0.03	2 0-0.2	5	M5 x 12L	1.4	1.9
M75030T-□S2	117.3	54.4	153	54.4	35	70 dia. 0-0.03	80	90	8	6	19 dia. 0-0.013	3	24	6 0-0.03	2.5 0-0.2	6		2.9	3.9

Models without brake

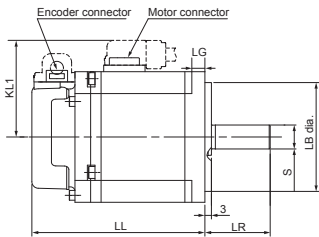

Models with brake

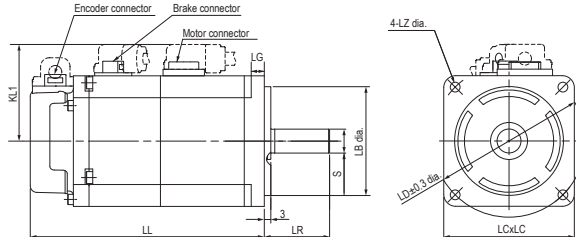

Shaft end

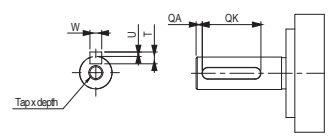

Type 3000 r/min motors (230 V, 1 kW to 1.5 kW / 400 V, 750 W to 3 kW)

Dimensions (mm)	Without brake				With brake				LR	Flange surface						Shaft end						Approx. mass (kg)		
	LL	KB1	KB2	KL1	LL	KB1	KB2	KL1		LB	LC	LD	LE	LG	LZ	S	QA	QK	W	U	T	Tap x depth	Without brake	With brake
Model: R88M-1□																								
L1K030T-□S2	168	85	153	97	209	85	194	97	55	95 dia. 0-0.035	100	115	3	10	9	19 dia. 0-0.013	3	42	6 0-0.03	2.5 0-0.2	6	M5 x 12L	5.7	7.4
L1K530T-□S2																								
L75030C-□S2	139	56	124		180	56	165	104															4.1	5.8
L1K030C-□S2	168	85	153		209	85	194																5.7	7.4
L1K530C-□S2																								
L2K030C-□S2	179	96	164		220	96	205																6.4	8.1
L3K030C-□S2	184	112	169	116	230	112	215	119		110 dia. 0-0.035	130	145	4	12	9	22 dia. 0-0.013			8 0-0.036	3 0-0.4	7		11.5	12.5

Models without brake

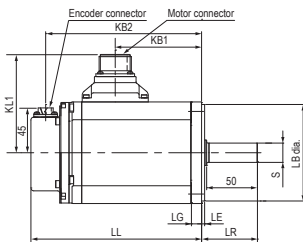

Models with brake

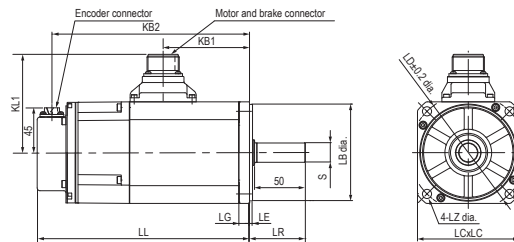

Shaft end

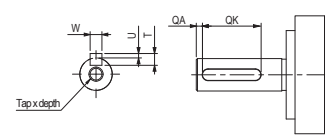

## Type 2000 r/min motors (400 V, 400 W to 600 W)

Dimensions (mm)	Without brake				With brake				Approx. mass (kg)	
	LL	KB1	KB2	KL1	LL	KB1	KB2	KL1	Without brake	With brake
Model: R88M-1□										
M40020C-□S2	134.8	52	120.5	97	152.3	52	138	104	3.9	4.8
M60020C-□S2	151.8	69	137.5		169.3	69	155		4.7	5.8

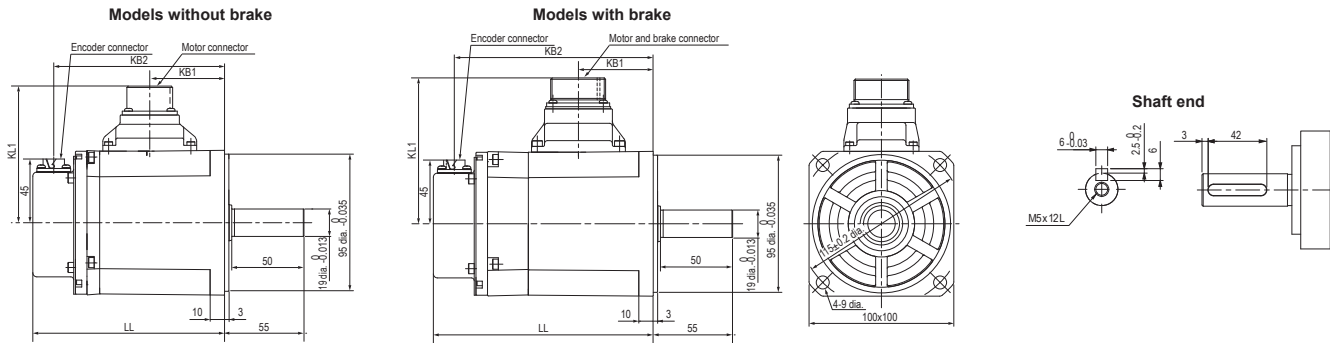

## Type 2000 r/min motors (230 V, 1 kW to 1.5 kW / 400 V, 1 kW to 3 kW)

Dimensions (mm)	Without brake					With brake					LR	Shaft end							Approx. mass (kg)		
	LL	KB1	KB2	KL1	KL2	LL	KB1	KB2	KL1	KL2		S	Q	QA	QK	W	U	T	Tap x depth	Without brake	With brake
Model: R88M-1□																					
M1K020T-□S2	120.5	63	109	76	118	162	63	149	76	118	55	22 dia. <sup>0</sup> <sub>-0.013</sub>	50	3	42	8 <sup>0</sup> <sub>-0.036</sub>	3 <sup>0</sup> <sub>-0.4</sub>	7	M5 x 12L	6.6	8.6
M1K520T-□S2	138	79	125			179	79	166												8.5	10.5
M1K020C-□S2	120.5	63	109			162	64	150		119										6.6	8.6
M1K520C-□S2	138	79	125			179	81	167												8.5	10.5
M2K020C-□S2	160	98	148			201	99	189												10.0	12.0
M3K020C-□S2	191	119	176	45	116	234	118	219	45	119	65	24 dia. <sup>0</sup> <sub>-0.013</sub>	60		52				M8 x 20L	12.0	15.0

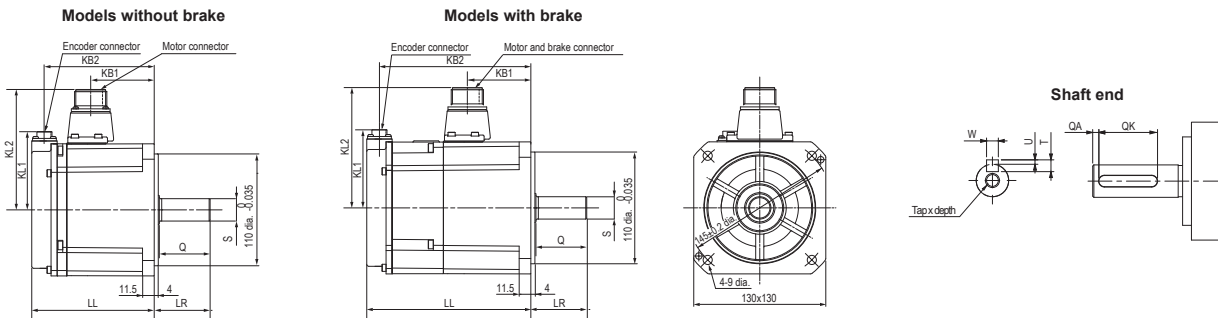

## Type 1000 r/min motors (230 V, 900 W / 400 V, 900 W)

Dimensions (mm)	Without brake					With brake					Approx. mass (kg)	
	LL	KB1	KB2	KL1	KL2	LL	KB1	KB2	KL1	KL2	Without brake	With brake
Model: R88M-1□												
M90010T-□S2	138	79	125	76	118	179	79	166	76	118	8.5	10.5
M90010C-□S2							81	167		117		

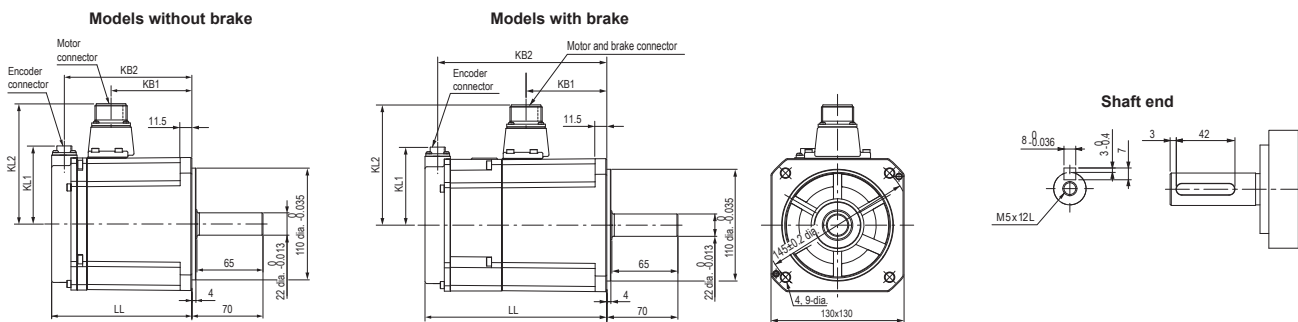



Type 1000 r/min motors (400 V, 2 kW)

Dimensions (mm)	Without brake					With brake					Approx. mass (kg)	
	LL	KB1	KB2	KL1	KL2	LL	KB1	KB2	KL1	KL2	Without brake	With brake
Model: R88M-1□												
M2K010C-□S2	159	93	145	45	141	206	92	191	45	144	18.0	22.0

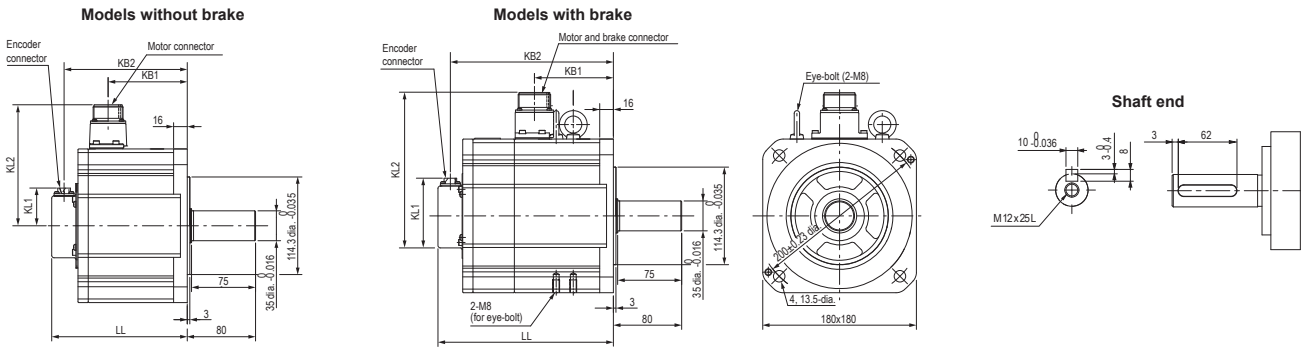

Type 1000 r/min motors (400 V, 3 kW)

Dimensions (mm)	Without brake					With brake					Approx. mass (kg)	
	LL	KB1	KB2	KL1	KL2	LL	KB1	KB2	KL1	KL2	Without brake	With brake
Model: R88M-1□												
M3K010C-□S2	228	162	213	45	141	274	162	260	45	144	28.0	33.0

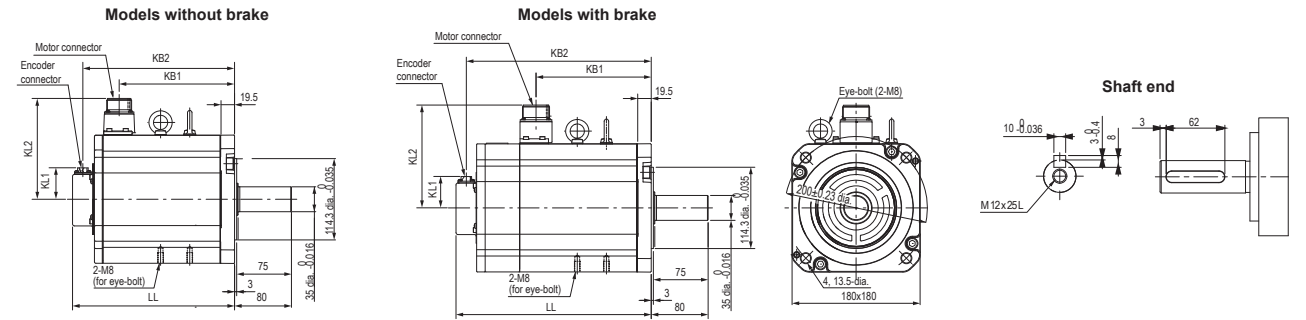

## Ordering information

(Refer to servo drive chapter)

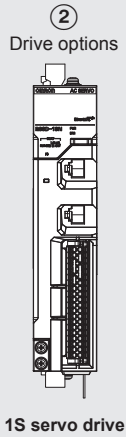

### 1S servo motor (Flange size 80 mm or less)

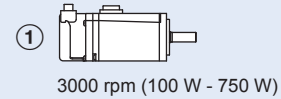
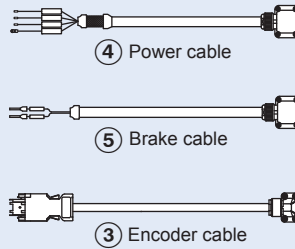

### 1S servo motor (Flange size 100 mm or more)

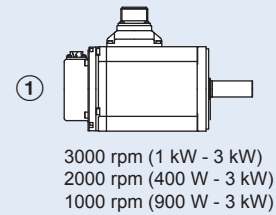
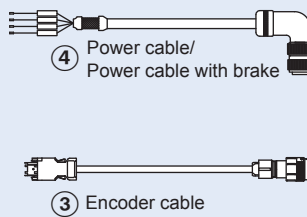

### Servo motors

① Select motor from R88M-1□ family using motor tables in next pages.

### Servo drives

② Refer to the 1S servo drive chapter for detailed drive specifications and selection of drive accessories.

### Servo motors

#### Servo motors 3000 r/min (100 W to 3 kW)

Symbol	Specifications					Model	Compatible 1S servo drive		
	Voltage	Encoder and design		Rated torque	Capacity			Flange size	
①	230 V	Absolute encoder (23-bit)	Without brake	0.318 Nm	100 W	40 mm	R88M-1M10030T-S2	R88D-1SN01H-ECT	
				0.637 Nm	200 W	60 mm	R88M-1M20030T-S2	R88D-1SN02H-ECT	
				1.27 Nm	400 W	60 mm	R88M-1M40030T-S2	R88D-1SN04H-ECT	
				2.39 Nm	750 W	80 mm	R88M-1M75030T-S2	R88D-1SN08H-ECT	
				3.18 Nm	1 kW	100 mm	R88M-1L1K030T-S2 <sup>*1</sup>	R88D-1SN15H-ECT	
				4.77 Nm	1.5 kW	100 mm	R88M-1L1K530T-S2 <sup>*1</sup>	R88D-1SN15H-ECT	
				0.318 Nm	100 W	40 mm	R88M-1M10030T-BS2	R88D-1SN01H-ECT	
		0.637 Nm	200 W	60 mm	R88M-1M20030T-BS2	R88D-1SN02H-ECT			
		1.27 Nm	400 W	60 mm	R88M-1M40030T-BS2	R88D-1SN04H-ECT			
		2.39 Nm	750 W	80 mm	R88M-1M75030T-BS2	R88D-1SN08H-ECT			
		3.18 Nm	1 kW	100 mm	R88M-1L1K030T-BS2 <sup>*1</sup>	R88D-1SN15H-ECT			
		4.77 Nm	1.5 kW	100 mm	R88M-1L1K530T-BS2 <sup>*1</sup>	R88D-1SN15H-ECT			
		400 V	Straight shaft with key and tap	Without brake	2.39 Nm	750 W	100 mm	R88M-1L75030C-S2 <sup>*1</sup>	R88D-1SN10F-ECT
					3.18 Nm	1 kW	100 mm	R88M-1L1K030C-S2 <sup>*1</sup>	R88D-1SN10F-ECT
	4.77 Nm				1.5 kW	100 mm	R88M-1L1K530C-S2 <sup>*1</sup>	R88D-1SN15F-ECT	
	6.37 Nm				2 kW	100 mm	R88M-1L2K030C-S2 <sup>*1</sup>	R88D-1SN20F-ECT	
	9.55 Nm				3 kW	130 mm	R88M-1L3K030C-S2 <sup>*1</sup>	R88D-1SN30F-ECT	
	2.39 Nm				750 W	100 mm	R88M-1L75030C-BS2 <sup>*1</sup>	R88D-1SN10F-ECT	
	With brake	3.18 Nm	1 kW	100 mm	R88M-1L1K030C-BS2 <sup>*1</sup>	R88D-1SN10F-ECT			
		4.77 Nm	1.5 kW	100 mm	R88M-1L1K530C-BS2 <sup>*1</sup>	R88D-1SN15F-ECT			
6.37 Nm		2 kW	100 mm	R88M-1L2K030C-BS2 <sup>*1</sup>	R88D-1SN20F-ECT				
9.55 Nm		3 kW	130 mm	R88M-1L3K030C-BS2 <sup>*1</sup>	R88D-1SN30F-ECT				

<sup>\*1</sup> Available soon.

Servo motors 2000 r/min (400 W to 3 kW)

Symbol	Specifications					Model	Compatible 1S servo drive		
	Voltage	Encoder and design		Rated torque	Capacity			Flange size	
①	230 V	Absolute encoder (23-bit)	Without brake	4.77 Nm	1 kW	130 mm	R88M-1M1K020T-S2	R88D-1SN15H-ECT	
				7.16 Nm	1.5 kW	130 mm	R88M-1M1K520T-S2	R88D-1SN15H-ECT	
			With brake	4.77 Nm	1 kW	130 mm	R88M-1M1K020T-BS2	R88D-1SN15H-ECT	
		Straight shaft with key and tap	400 V	Without brake	1.91 Nm	400 W	100 mm	R88M-1M40020C-S2	R88D-1SN06F-ECT
					2.86 Nm	600 W	100 mm	R88M-1M60020C-S2	R88D-1SN06F-ECT
					4.77 Nm	1 kW	130 mm	R88M-1M1K020C-S2	R88D-1SN10F-ECT
	With brake		7.16 Nm	1.5 kW	130 mm	R88M-1M1K520C-S2	R88D-1SN15F-ECT		
			9.55 Nm	2 kW	130 mm	R88M-1M2K020C-S2	R88D-1SN20F-ECT		
			14.3 Nm	3 kW	130 mm	R88M-1M3K020C-S2	R88D-1SN30F-ECT		
	400 V	Without brake		1.91 Nm	400 W	100 mm	R88M-1M40020C-BS2	R88D-1SN06F-ECT	
				2.86 Nm	600 W	100 mm	R88M-1M60020C-BS2	R88D-1SN06F-ECT	
				4.77 Nm	1 kW	130 mm	R88M-1M1K020C-BS2	R88D-1SN10F-ECT	
				7.16 Nm	1.5 kW	130 mm	R88M-1M1K520C-BS2	R88D-1SN15F-ECT	
		With brake		9.55 Nm	2 kW	130 mm	R88M-1M2K020C-BS2	R88D-1SN20F-ECT	
			14.3 Nm	3 kW	130 mm	R88M-1M3K020C-BS2	R88D-1SN30F-ECT		

Servo motors 1000 r/min (900 W to 3 kW)





Symbol	Specifications					Model	Compatible 1S servo drive		
	Voltage	Encoder and design		Rated torque	Capacity			Flange size	
①	230 V	Absolute encoder (23-bit)	Without brake	8.59 Nm	900 W	130 mm	R88M-1M90010T-S2	R88D-1SN15H-ECT	
			With brake	8.59 Nm	900 W	130 mm	R88M-1M90010T-BS2	R88D-1SN15H-ECT	
	400 V	Straight shaft with key and tap	Without brake	8.59 Nm	900 W	130 mm	R88M-1M90010C-S2	R88D-1SN10F-ECT	
					19.1 Nm	2 kW	180 mm	R88M-1M2K010C-S2	R88D-1SN20F-ECT
					28.7 Nm	3 kW	180 mm	R88M-1M3K010C-S2	R88D-1SN30F-ECT
			With brake	8.59 Nm	900 W	130 mm	R88M-1M90010C-BS2	R88D-1SN10F-ECT	
					19.1 Nm	2 kW	180 mm	R88M-1M2K010C-BS2	R88D-1SN20F-ECT
					28.7 Nm	3 kW	180 mm	R88M-1M3K010C-BS2	R88D-1SN30F-ECT

Encoder cables

Symbol	Specifications	Model	Appearance
③	Encoder cable for servo motors R88M-1M(100/200/400/750)30T-□	1.5 m	R88A-CR1A001-5CF-E
		3 m	R88A-CR1A003CF-E
		5 m	R88A-CR1A005CF-E
		10 m	R88A-CR1A010CF-E
		15 m	R88A-CR1A015CF-E
		20 m	R88A-CR1A020CF-E
	Encoder cable for servo motors R88M-1L(1K0/1K5)30T-□ R88M-1L(750/1K0/1K5/2K0/3K0)30C-□ R88M-1M(1K0/1K5)20T-□ R88M-1M(400/600/1K0/1K5/2K0/3K0)20C-□ R88M-1M90010T-□ R88M-1M(900/2K0/3K0)10C-□	1.5 m	R88A-CR1B001-5NF-E
		3 m	R88A-CR1B003NF-E
		5 m	R88A-CR1B005NF-E
		10 m	R88A-CR1B010NF-E
		15 m	R88A-CR1B015NF-E
		20 m	R88A-CR1B020NF-E

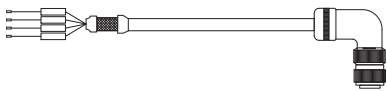
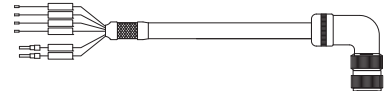
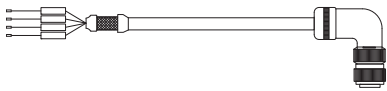
Power cables

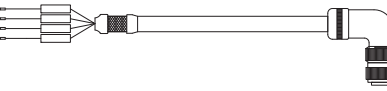
Symbol	Specifications	Model	Appearance	
④	For 230 V servo motors R88M-1M(100/200/400/750)30T-□S2  Note: For servo motors with brake R88M-1M(100/200/400/750)30T-BS2, the separate brake cable R88A-CA1□□BF-E is needed.	Without brake	1.5 m	R88A-CA1A001-5SF-E
			3 m	R88A-CA1A003SF-E
			5 m	R88A-CA1A005SF-E
			10 m	R88A-CA1A010SF-E
			15 m	R88A-CA1A015SF-E
			20 m	R88A-CA1A020SF-E

Symbol	Specifications		Model	Appearance		
④	For 230 V servo motors R88M-1L(1K0/1K5)30T-□S2 R88M-1M(1K0/1K5)20T-□S2 R88M-1M90010T-□S2	Without brake	1.5 m	R88A-CA1C001-5SF-E		
			3 m	R88A-CA1C003SF-E		
			5 m	R88A-CA1C005SF-E		
			10 m	R88A-CA1C010SF-E		
			15 m	R88A-CA1C015SF-E		
			20 m	R88A-CA1C020SF-E		
		With brake	1.5 m	R88A-CA1C001-5BF-E		
			3 m	R88A-CA1C003BF-E		
			5 m	R88A-CA1C005BF-E		
			10 m	R88A-CA1C010BF-E		
			15 m	R88A-CA1C015BF-E		
			20 m	R88A-CA1C020BF-E		
	For 400 V servo motors R88M-1L(750/1K0/1K5/2K0)30C-□S2 R88M-1M(400/600/1K0/1K5/2K0)20C-□S2 R88M-1M90010C-□S2	Without brake	1.5 m	R88A-CA1C001-5SF-E		
			3 m	R88A-CA1C003SF-E		
			5 m	R88A-CA1C005SF-E		
			10 m	R88A-CA1C010SF-E		
			15 m	R88A-CA1C015SF-E		
			20 m	R88A-CA1C020SF-E		
		With brake	1.5 m	R88A-CA1E001-5BF-E		
			3 m	R88A-CA1E003BF-E		
			5 m	R88A-CA1E005BF-E		
			10 m	R88A-CA1E010BF-E		
			15 m	R88A-CA1E015BF-E		
			20 m	R88A-CA1E020BF-E		
For 400 V servo motors R88M-1L3K030C-□S2 R88M-1M3K020C-□S2 R88M-1M(2K0/3K0)10C-□S2	Without brake	1.5 m	R88A-CA1E001-5SF-E			
		3 m	R88A-CA1E003SF-E			
		5 m	R88A-CA1E005SF-E			
		10 m	R88A-CA1E010SF-E			
		15 m	R88A-CA1E015SF-E			
		20 m	R88A-CA1E020SF-E			
	With brake	1.5 m	R88A-CA1E001-5BF-E			
		3 m	R88A-CA1E003BF-E			
		5 m	R88A-CA1E005BF-E			
		10 m	R88A-CA1E010BF-E			
		15 m	R88A-CA1E015BF-E			
		20 m	R88A-CA1E020BF-E			

**Brake cables (for 230 V, 100 W to 750 W servo motors)**

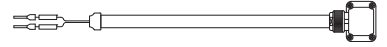
Symbol	Specifications		Model	Appearance
⑤	Brake cable only For 230 V servo motors with brake R88M-1M(100/200/400/750)30T-BS2	1.5 m	R88A-CA1A001-5BF-E	
		3 m	R88A-CA1A003BF-E	
		5 m	R88A-CA1A005BF-E	
		10 m	R88A-CA1A010BF-E	
		15 m	R88A-CA1A015BF-E	
		20 m	R88A-CA1A020BF-E	

Connectors for encoder, power and brake cables

Specifications		Applicable servo motor	Manufacturer	Model	
Connectors for encoder cables	Drive side (CN2)	All models	OMRON	R88A-CN101R	
	Motor side	R88M-1M(100/200/400/750)30T-□	OMRON	R88A-CNK02R	
R88M-1L(1K0/1K5)30T-□		OMRON	R88A-CN104R		
R88M-1L(750/1K0/1K5/2K0/3K0)30C-□					
R88M-1M(1K0/1K5)20T-□					
R88M-1M(400/600/1K0/1K5/2K0/3K0)20C-□					
R88M-1M90010T-□					
R88M-1M(900/2K0/3K0)10C-□					
Connectors for power cables	Motor side	R88M-1M(100/200/400/750)30T-S2	OMRON	R88A-CN111A	
		R88M-1L(1K0/1K5)30T-S2	Amphenol	MS3108-EGM21-20-4S	
		R88M-1M(1K0/1K5)20T-S2			
		R88M-1M90010T-S2			
		R88M-1L(750/1K0/1K5/2K0)30C-S2			
		R88M-1M(400/600/1K0/1K5/2K0)20C-S2			
		R88M-1M90010C-S2			
		R88M-1L(1K0/1K5)30T-BS2	Amphenol	MS3108-EGM21-20-18S-22S	
		R88M-1M(1K0/1K5)20T-BS2			
		R88M-1M90010T-BS2			
R88M-1L3K030C-S2	Amphenol	MS3108-EGM21-22-22S			
R88M-1M3K020C-S2					
R88M-1M(2K0/3K0)10C-S2					
R88M-1L(750/1K0/1K5/2K0/3K0)30C-BS2	Amphenol	MS3108-EGM21-24-11S			
R88M-1M(400/600/1K0/1K5/2K0/3K0)20C-BS2					
R88M-1M(900/2K0/3K0)10C-BS2					
Connectors for brake cables	Motor side	R88M-1M(100/200/400/750)30T-BS2	OMRON	R88A-CN111B	

ALL DIMENSIONS SHOWN ARE IN MILLIMETERS.  
 To convert millimeters into inches, multiply by 0.03937. To convert grams into ounces, multiply by 0.03527.

Cat. No. SysCat\_1189E-EN-01 In the interest of product improvement, specifications are subject to change without notice.