

NI20-EG18FM-AP6X-H1141

Inductive Sensor – Stainless Steel Front

Features

- Threaded barrel, M18 x 1
- Stainless steel, 1.4305
- DC 3-wire, 10...30 VDC
- NO contact, PNP output
- M12 x 1 male connector

Wiring diagram

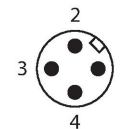
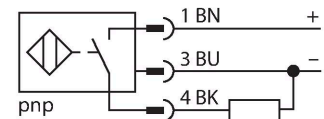

Functional principle

The inductive all-metal switches operate on the basis of the electromagnetic pulse method. Unlike standard inductive sensors, the magnetic field is not generated through oscillation but through short, periodic current pulses flowing through the coil. The magnetic field induces voltage in the object to be detected, which, for its part creates a current flow in this object. After switching off the current pulse, the current in the object also drops, now inducing voltage back in the emitter coil. This voltage is the wanted signal and remains unaffected by energy dissipation in the magnetic field. Only non-ferromagnetic or poorly conductive metals provide a low signal.

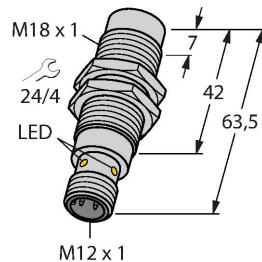

Technical data

Type	NI20-EG18FM-AP6X-H1141
ID	4614709
General data	
Rated switching distance	20 mm
Mounting conditions	Non-flush
Secured operating distance	≤ (0.81 × S _n) mm
Correction factors	St37 = 1; Al = 1; Cu = 0.9; stainless steel 1 mm = 0.2; stainless steel 2 mm = 0.7; Ms = 1.35
Repeat accuracy	≤ 5 % of full scale
Static pressure	≤ 60 bar
Temperature drift	≤ ±10 %
Hysteresis	15 %
Electrical data	
Operating voltage	10...30 VDC
Residual ripple	≤ 20 % U _{ss}
DC rated operational current	≤ 200 mA
No-load current	10 mA
Residual current	≤ 0.1 mA
Isolation test voltage	≤ 0.5 kV
Short-circuit protection	yes / Cyclic
Voltage drop at I _o	≤ 2 V
Wire breakage/Reverse polarity protection	yes / Complete
Output function	3-wire, NO contact, PNP
Switching frequency	0.2 kHz

Technical data

Mechanical data	
Design	Threaded barrel, M18 × 1
Dimensions	63.5 mm
Housing material	Stainless steel, 1.4305 (AISI 303)
Active area material	Stainless steel, 1.4305 (AISI 303)
Admissible pressure on front cap	≤ 60 bar
Max. tightening torque of housing nut	50 Nm
Electrical connection	Connector, M12 × 1
Environmental conditions	
Ambient temperature	-25...+70 °C
Vibration resistance	55 Hz (1 mm)
Shock resistance	30 g (11 ms)
Protection class	IP68 IP69K
MTTF	377 years acc. to SN 29500 (Ed. 99) 20 °C
Switching state	LED, Yellow, LED flashing: 0.8 s, < s ≤ s,

Mounting instructions

Mounting instructions/Description

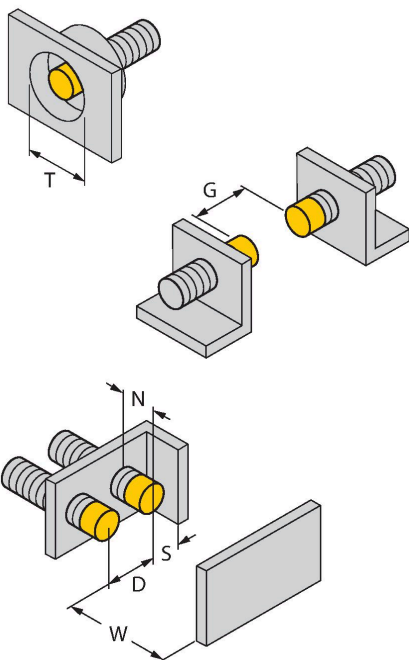

Distance D	200 mm
Distance W	60 mm
Distance T	100 mm
Distance S	50 mm
Distance G	120 mm
Distance N	35 mm
Diameter active area B	Ø 18 mm

When mounted in non-ferrous metals the distance N will be reduced to:
 Aluminium: 20 mm
 Brass: 22 mm

Accessories

MW-18

6945004

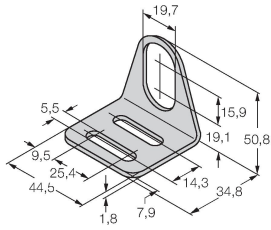

Mounting bracket for threaded barrel sensors; material: Stainless steel A2 1.4301 (AISI 304)

BSS-18

6901320

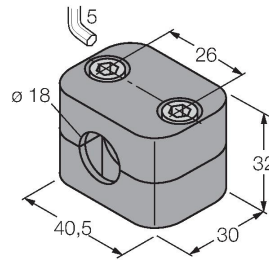

Mounting clamp for smooth and threaded barrel sensors; material: Polypropylene

QM-18

6945102

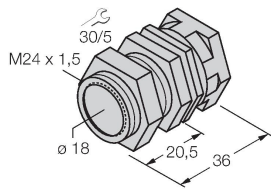

Quick-mount bracket with dead-stop; material: Chrome-plated brass. Male thread M24 × 1.5. Note: The switching distance of the proximity switches may change when using quick-mount brackets.