

Selector Switches

A22NS/A22NW

22-mm Selector Switches
Universal Design.
Emphasis on Color Coding,
Workability, and Safety.



Easy to Use

- You can connect up to three Contact Blocks in one stage for multistage expansion.
- Screw terminal structure is compatible with round crimp terminals.

Safety

- Easy-to-operate lock lever for secure locking.
- Easy-mounting Contact Blocks provide finger protection.
- Different colors of Contact Blocks (NO: blue, NC: orange) help prevent wiring errors.

Product Lineup

- Meets global safety standards.
- Available in metal and plastic bezels.
- Many color variations.
- Standard-feature degree of protection: IP66, NEMA 4X, and NEMA 13.

Refer to *Safety Precautions for All Pushbutton Switches/Indicators* and *Safety Precautions in the A22NN/A22NL* datasheet





Operation Unit Colors





		Red	Green	Yellow	White	Blue	Black		
Non-lighted Switches	A22NS-□□□-N□ Opaque								
		Red	Green	Yellow	White	Blue	Orange	White	
Lighted Switches	A22NW-□□□-T□ Transparent	When not lit							
		When lit	Red	Green	Yellow	White	Blue	Orange	Opaque white*

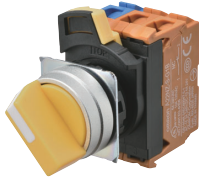

* The colors when the Switches are lit are for transparent white Operation Units (code: TW) and yellow LED Lamps (code: Y).

A22NS/A22NW

List of Models

Plastic Switches			
Non-lighted		Lighted	
Two Positions	Three Positions	Two Positions	Three Positions
			

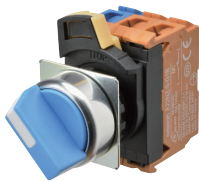
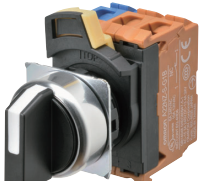
Brushed Metal Switches			
Non-lighted		Lighted	
Two Positions	Three Positions	Two Positions	Three Positions
			

Metal Switches			
Non-lighted		Lighted	
Two Positions	Three Positions	Two Positions	Three Positions
			

Note: Not all assembled configurations are possible.
Please refer to the subassemblies section for additional options.
Please refer to the specifications section for examples of linked contact block options.

Model Number Structure

Model Number Legend - Shipped as a set that includes the Operation Unit, LED Lamp, Mounting Collar, and Contact Block.
For information on combinations, refer to *Ordering Information* on pages 6 to 8.

Model Numbers for Sets

A 22 N ⁽¹⁾ W - ⁽²⁾ 2B ⁽³⁾ M - ⁽⁴⁾ NR ⁽⁵⁾ A - ⁽⁶⁾ G ⁽⁷⁾ 101 - ⁽⁸⁾ R ⁽⁹⁾ A



(1) Type

Code	Type
S	Non-lighted
W	Lighted

(2) Number of Positions and Bezel Material

Code	No. of positions	Bezel material
2B	2	Plastic
2M	2	Brushed metal
2R	2	Metal
3B	3	Plastic
3M	3	Brushed metal
3R	3	Metal

(3) Reset Method

Code	Reset method		
M	Manual	Two-position manual	
		Three-position manual	

(4) Operation Unit Transparency and Color and (8) LED Lamp Color

Lighted/non-lighted	Code (4)	Code (8)	Transparency	Operation Unit color	LED Lamp color
Non-lighted	NR	N	Opaque	Red	---
	NG		Opaque	Green	
	NY		Opaque	Yellow	
	NW		Opaque	White	
	NA		Opaque	Blue	
	NB		Opaque	Black	
Lighted	TR	R	Transparent	Red	Red
	TG	G	Transparent	Green	Green
	TY	Y	Transparent	Yellow	Yellow
	TW	W	Transparent	White	White
	TA	A	Transparent	Blue	Blue
	TO	O	Transparent	Orange	Orange
	TW	Y	Transparent	White*	Yellow

* The color is opaque white when the Switch is lit.

(5) Degree of Protection

Code	Protection
A	IP66, NEMA 4X, NEMA13

(6) Contacts

Code	Description
G	General purpose

(7) Contact Configuration

Code	Contact Blocks		Non-lighted						Lighted				
			Switch position			No. of positions			Switch position			No. of positions	
	NO	NC	(1)	(2)	(3)	Two positions	Three positions	(1)	(2)	(3)	Two positions	Three positions	
100	1	0	NO	---	---	Yes		NO	Lighting Unit	---	Yes		
002	0	1	---	---	NC	Yes		---	Lighting Unit	NC	Yes		
101	2	0	NO	---	NO	Yes	Yes	NO	Lighting Unit	NO	Yes	Yes	
102	1	1	NO	---	NC	Yes	Yes	NO	Lighting Unit	NC	Yes	Yes	
201	1	1	NC	---	NO		Yes	NC	Lighting Unit	NO		Yes	
202	0	2	NC	---	NC	Yes	Yes	NC	Lighting Unit	NC	Yes	Yes	
110	2	0	NO	NO	---		Yes						
210	1	1	NC	NO	---		Yes						
011	2	0	---	NO	NO		Yes						
012	1	1	---	NO	NC		Yes						
120	1	1	NO	NC	---		Yes						
220	0	2	NC	NC	---		Yes						
021	1	1	---	NC	NO		Yes						
022	0	2	---	NC	NC		Yes						

Note: 1. NO (blue): Normally open, NC (orange): Normally closed.
2. Refer to the following figure for the Unit positions.

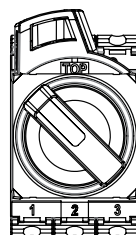

(9) LED Lamp Voltage

Code	LED Lamp voltage
N	Non-lighted
A	6 VAC/DC
B	12 VAC/DC
C	24 VAC/DC
D	100/110/120 VAC
E	200/220/230/240 VAC

Note: Not all assembled configurations are possible.
Please refer to the subassemblies section for additional options.
Please refer to the specifications section for examples of linked contact block options.

■ Specifications: Refer to page 14 and refer to the A22NN/A22NL. ■ Precautions for correct use: Refer to the A22NN/A22NL.
■ Dimensions: Refer to page 15.

Structure

Contact Configuration Table

Two Positions

No. of outputs	Code	Contact configuration	Switch position	Contacts	Position	
					1	2
1	100	SPST-NO	(1)	NO		ON
			(2)	---	---	---
			(3)	---	---	---
1	002	SPST-NC	(1)	---	---	---
			(2)	---	---	---
			(3)	NC	ON	
2	102	SPST-NO/ SPST-NC	(1)	NO		ON
			(2)	---	---	---
			(3)	NC	ON	
2	101	DPST-NO	(1)	NO		ON
			(2)	---	---	---
			(3)	NO		ON
2	202	DPST-NC	(1)	NC	ON	
			(2)	---	---	---
			(3)	NC	ON	
3	111	3PST-NO	(1)	NO		ON
			(2)	NO		ON
			(3)	NO		ON
3	222	3PST-NC	(1)	NC	ON	
			(2)	NC	ON	
			(3)	NC	ON	
3	122	SPST-NO/ DPST-NC	(1)	NO		ON
			(2)	NC	ON	
			(3)	NC	ON	
3	112	DPST-NO/ SPST-NC	(1)	NO		ON
			(2)	NO		ON
			(3)	NC	ON	

Operation Angle

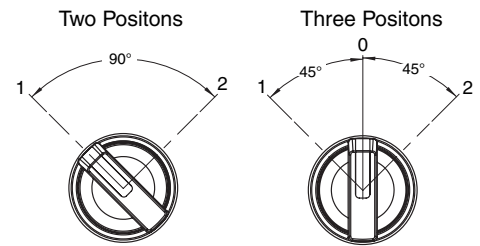

Three Positions

No. of outputs	Code	Contact configuration	Switch position	Contacts	Position		
					1	0	2
2	110	DPST-NO	(1)	NO	ON		
			(2)	NO	ON		ON
			(3)	---	---	---	---
2	011	DPST-NO	(1)	---	---	---	---
			(2)	NO	ON		ON
			(3)	NO			ON
2	101	DPST-NO	(1)	NO	ON		
			(2)	---	---	---	---
			(3)	NO			ON
2	220	DPST-NC	(1)	NC		ON	ON
			(2)	NC		ON	
			(3)	---	---	---	---
2	022	DPST-NC	(1)	---	---	---	---
			(2)	NC		ON	
			(3)	NC	ON	ON	
2	202	DPST-NC	(1)	NC		ON	ON
			(2)	---	---	---	---
			(3)	NC	ON	ON	

Note: Not all assembled configurations are possible.
Please refer to the subassemblies section for additional options.
Please refer to the specifications section for examples of linked contact block options.

No. of outputs	Code	Contact configuration	Switch position	Contacts	Position		
					1	0	2
2	120	SPST-NO/ SPST-NC	(1)	NO	ON		
			(2)	NC		ON	
			(3)	---	---	---	---
2	102	SPST-NO/ SPST-NC	(1)	NO	ON		
			(2)	---	---	---	---
			(3)	NC	ON	ON	
2	210	SPST-NO/ SPST-NC	(1)	NC		ON	ON
			(2)	NO	ON		ON
			(3)	---	---	---	---
2	201	SPST-NO/ SPST-NC	(1)	NC		ON	ON
			(2)	---	---	---	---
			(3)	NO			ON
2	012	SPST-NO/ SPST-NC	(1)	---	---	---	---
			(2)	NO	ON		ON
			(3)	NC	ON	ON	
2	021	SPST-NO/ SPST-NC	(1)	---	---	---	---
			(2)	NC		ON	
			(3)	NO			ON
3	111	3PST-NO	(1)	NO	ON		
			(2)	NO	ON		ON
			(3)	NO			ON
3	222	3PST-NC	(1)	NC		ON	ON
			(2)	NC		ON	
			(3)	NC	ON	ON	
3	122	SPST-NO/ DPST-NC	(1)	NO	ON		
			(2)	NC		ON	
			(3)	NC	ON	ON	
3	212	SPST-NO/ DPST-NC	(1)	NC		ON	ON
			(2)	NO	ON		ON
			(3)	NC	ON	ON	
3	221	SPST-NO/ DPST-NC	(1)	NC		ON	ON
			(2)	NC		ON	
			(3)	NO	ON		ON
3	211	DPST-NO/ SPST-NC	(1)	NC		ON	ON
			(2)	NO	ON		ON
			(3)	NO			ON
3	121	DPST-NO/ SPST-NC	(1)	NO	ON		
			(2)	NC		ON	
			(3)	NO			ON
3	112	DPST-NO/ SPST-NC	(1)	NO	ON		
			(2)	NO	ON		ON
			(3)	NC	ON	ON	

Operation Angle

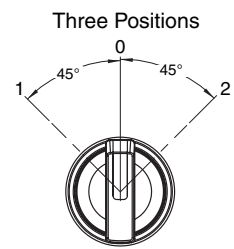

Note: Some combinations are only available through subassemblies. Please refer to the specifications section for more information.

A22NS/A22NW

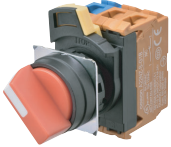
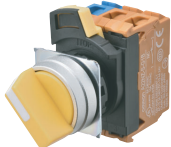
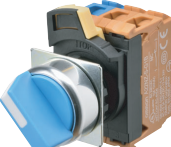

Ordering Information

Model Numbers for Sets - - - Shipped as a set that includes the Operation Unit, LED Lamp, Mounting Collar, and Contact Block.
Non-lighted, Two-position, Selector Switches

Appearance	Bezel material	No. of outputs	Model	(3) Reset method	(4)(4) Operation Unit color	(7)(7)(7) Contact configuration				
Plastic bezels 	2B	1	A22NS-2B(3)-(4)(4)A-G(7)(7)(7)-NN	M: Manual	NR: Opaque red NG: Opaque green NY: Opaque yellow NW: Opaque white NA: Opaque blue NB: Opaque black	100 002				
		2				102 101 202				
Brushed metal bezels 	2M	1	A22NS-2M(3)-(4)(4)A-G(7)(7)(7)-NN			M: Manual	NR: Opaque red NG: Opaque green NY: Opaque yellow NW: Opaque white NA: Opaque blue NB: Opaque black	100 002		
		2						102 101 202		
Metal bezels 	2R	1	A22NS-2R(3)-(4)(4)A-G(7)(7)(7)-NN					M: Manual	NR: Opaque red NG: Opaque green NY: Opaque yellow NW: Opaque white NA: Opaque blue NB: Opaque black	100 002
		2								102 101 202

Note: Not all assembled configurations are possible.
 Please refer to the subassemblies section for additional options.
 Please refer to the specifications section for examples of linked contact block options.

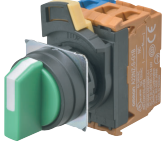
Non-lighted, Three-position, Selector Switches



Appearance	Bezel material	No. of outputs	Model	(3) Reset method	(4)(4) Operation Unit color	(7)(7)(7) Contact configuration
Plastic bezels 	3B	2	A22NS-3B(3)-(4)(4)A-G(7)(7)-NN	M: Manual	NR: Opaque red NG: Opaque green NY: Opaque yellow NW: Opaque white NA: Opaque blue NB: Opaque black	110 011 101 220 022 202 120 102 210 201 012 021
Brushed metal bezels 		2	A22NS-3(3)-(4)(4)A-G(7)(7)-NN			110 011 101 220 022 202 120 102 210 201 012 021
Metal bezels 	3R	2	A22NS-3R(3)-(4)(4)A-G(7)(7)-NN			110 011 101 220 022 202 120 102 210 201 012 021

Note: Not all assembled configurations are possible.
 Please refer to the subassemblies section for additional options.
 Please refer to the specifications section for examples of linked contact block options.



A22NS/A22NW

Ordering Information

Model Numbers for Sets - - - Shipped as a set that includes the Operation Unit, LED Lamp, Mounting Collar, and Contact Block.
Lighted, Two-position, Selector Switches

Appearance	Bezel material	No. of outputs	Model	(3) Reset method	(4)(4) Operation Unit color	(7)(7)(7) Contact Configuration	(8) LED Lamp color	(9) LED Lamp voltage
Plastic bezels 	2B	1	A22NW-2B(3)-(4)(4)A-G(7)(7)(7)-(8)(9)	M: Manual	TR: Transparent red TG: Transparent green TY: Transparent yellow TW: Transparent white TA: Transparent blue TO: Transparent orange	100 002	R: Red G: Green Y: Yellow A: Blue O: Orange	A: 6 VAC/DC B: 12 VAC/DC C: 24 VAC/DC D: 100/110/120 VAC E: 200/220/230/240 VAC
		2						
Brushed metal bezels 	2M	1	A22NW-2M(3)-(4)(4)A-G(7)(7)(7)-(8)(9)			100 002		
		2						
Metal bezels 	2R	1	A22NW-2R(3)-(4)(4)A-G(7)(7)(7)-(8)(9)			100 002		
		2						

Lighted, Three-position, Selector Switches

Appearance	Bezel material	No. of outputs	Model	(3) Reset method	(4)(4) Operation Unit color	(7)(7)(7) Contact Configuration	(8) LED Lamp color	(9) LED Lamp voltage
Plastic bezels 	3B	2	A22NW-3B(3)-(4)(4)A-G(7)(7)(7)-(8)(9)	M: Manual	TR: Transparent red TG: Transparent green TY: Transparent yellow TW: Transparent white TA: Transparent blue TO: Transparent orange	101 202 102 201	R: Red G: Green Y: Yellow A: Blue O: Orange	A: 6 VAC/DC B: 12 VAC/DC C: 24 VAC/DC D: 100/110/120 VAC E: 200/220/230/240 VAC
Metal bezels 	3R	2	A22NW-3R(3)-(4)(4)A-G(7)(7)(7)-(8)(9)			101 202 102 201		

Note: Normally, the Operation Unit and LED Lamp with the same color are combined.
 However, opaque white is available by combining a white Operation Unit and yellow LED. A22N□-□□□-TWA-G□□□-Y□

Note: Not all assembled configurations are possible.
 Please refer to the subassemblies section for additional options.
 Please refer to the specifications section for examples of linked contact block options.

■ Subassemblies: Refer to pages 9 to 13.
 (You can order Operation Units, LED Lamps, Mounting Collars, and Contact Blocks individually.)

■ Specifications: Refer to page 14 and refer to the A22NN/A22NL.
 ■ Dimensions: Refer to page 15.
 ■ Accessories and tools: Refer to the A22NN/A22NL.

Ordering Information

Subassemblies - - - - You can order Operation Units, LED Lamps, Mounting Collars, and Contact Blocks individually. Use them in combination for models that are not available as assembled Switches. They can also be used as inventory for maintenance parts.

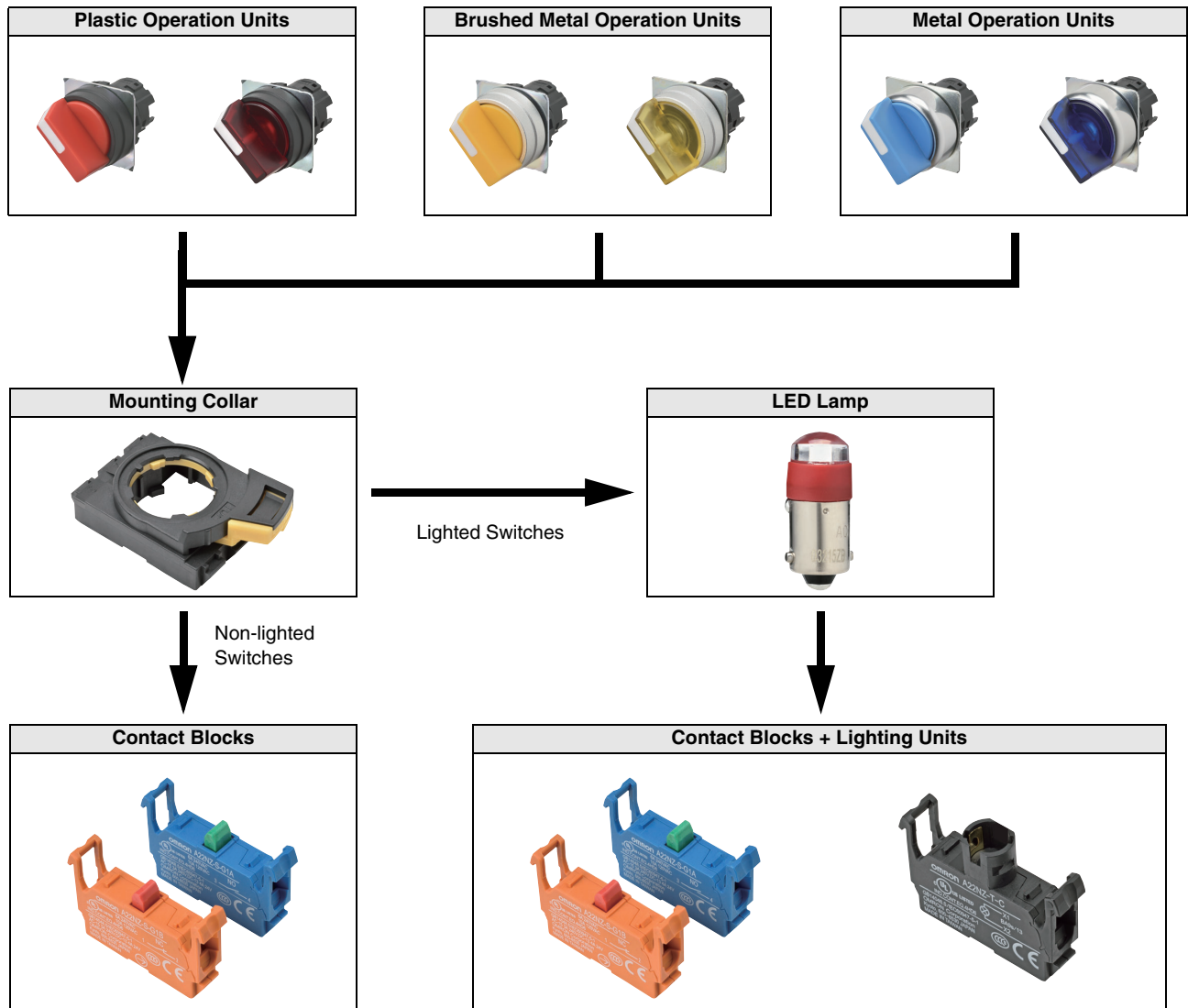

Note: Use a Reinforcement Plate for greater strength.

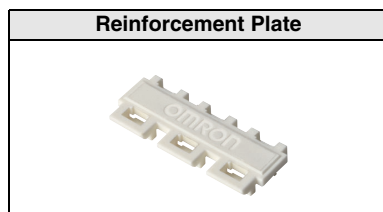

■ Model numbers of sets: Refer to pages 6 to 8.

■ Specifications: Refer to page 14 and refer to the A22NN/A22NL.
 ■ Dimensions: Refer to page 15.
 ■ Accessories and tools: Refer to the A22NN/A22NL.

A22NS/A22NW

Model Number Structure

Model Number Legend

Model Numbers for Subassemblies

A 2 2 N ⁽¹⁾ Z - ⁽²⁾ 2B ⁽³⁾ M - ⁽⁴⁾ NR ⁽⁵⁾ A

(1) Type

Code	Type
Z	Subassembly

(2) Number of Positions and Bezel Material

Code	No. of positions	Bezel material
2B	2	Plastic
2M	2	Brushed metal
2R	2	Metal
3B	3	Plastic
3M	3	Brushed metal
3R	3	Metal

(3) Reset Method

Code	Reset method		
M	Manual	Two-position manual	
		Three-position manual	
L	Automatic reset on left	Two-position automatic	
		Three-position left automatic	
R	Automatic reset on right	Three-position right automatic	
B	Automatic reset on left and right	Three-position left or right automatic	

(4) Operation Unit Transparency and Color

Lighted/non-lighted	Code (4)	Code (8)	Transparency	Operation Unit color	LED Lamp color
Non-lighted	NR	N	Opaque	Red	---
	NG		Opaque	Green	
	NY		Opaque	Yellow	
	NW		Opaque	White	
	NA		Opaque	Blue	
	NB		Opaque	Black	
Lighted	TR	R	Transparent	Red	Red
	TG	G	Transparent	Green	Green
	TY	Y	Transparent	Yellow	Yellow
	TW	W	Transparent	White	White
	TA	A	Transparent	Blue	Blue
	TO	O	Transparent	Orange	Orange

(5) Degree of Protection

Code	Protective code
A	IP66, NEMA 4X, NEMA13

■ Specifications: Refer to page 14 and refer to the A22NN/A22NL.
 ■ Dimensions: Refer to page 15.

■ Precautions for correct use: Refer to the A22NN/A22NL.

Ordering Information

Subassemblies ----- You can order Operation Units, LED Lamps, Mounting Collars, and Contact Blocks individually. Use them in combination for models that are not available as assembled Switches. They can also be used as inventory for maintenance parts.

Operation Unit Non-lighted Switches

No. of positions		Reset method		Bezel material and shape		Plastic		Brushed metal		Metal			
				Operation Unit color		Model	Model	Model	Model				
2	Manual	Opaque red	Automatic reset on left	A22NZ-2BM-NRA	A22NZ-2MM-NRA	A22NZ-2RM-NRA	A22NZ-2BL-NRA	A22NZ-2ML-NRA	A22NZ-2RL-NRA	A22NZ-3BM-NRA	A22NZ-3MM-NRA	A22NZ-3RM-NRA	
	Automatic reset on left												A22NZ-3BL-NRA
3	Manual		A22NZ-3BR-NRA	A22NZ-3MR-NRA	A22NZ-3RR-NRA								
	Automatic reset on left		A22NZ-3BB-NRA	A22NZ-3MB-NRA	A22NZ-3RB-NRA								
	Automatic reset on right		A22NZ-2BM-NGA	A22NZ-2MM-NGA	A22NZ-2RM-NGA								
2	Manual		Opaque green	Automatic reset on left	A22NZ-2BL-NGA	A22NZ-2ML-NGA	A22NZ-2RL-NGA	A22NZ-3BM-NGA	A22NZ-3MM-NGA	A22NZ-3RM-NGA	A22NZ-3BL-NGA	A22NZ-3ML-NGA	A22NZ-3RL-NGA
	Automatic reset on left												
	3			Manual	A22NZ-3BB-NGA	A22NZ-3MB-NGA	A22NZ-3RB-NGA						
				Automatic reset on right	A22NZ-2BM-NYA	A22NZ-2MM-NYA	A22NZ-2RM-NYA						
2	Manual			Opaque yellow	Automatic reset on left	A22NZ-2BL-NYA	A22NZ-2ML-NYA	A22NZ-2RL-NYA	A22NZ-3BM-NYA	A22NZ-3MM-NYA	A22NZ-3RM-NYA	A22NZ-3BL-NYA	A22NZ-3ML-NYA
	Automatic reset on left	A22NZ-3BR-NYA											
	3	Manual			A22NZ-3BB-NYA	A22NZ-3MB-NYA	A22NZ-3RB-NYA						
		Automatic reset on right			A22NZ-2BM-NWA	A22NZ-2MM-NWA	A22NZ-2RM-NWA						
		Automatic reset on left and right			A22NZ-2BL-NWA	A22NZ-2ML-NWA	A22NZ-2RL-NWA						
2	Manual	Opaque white			Automatic reset on left	A22NZ-3BM-NWA	A22NZ-3MM-NWA	A22NZ-3RM-NWA	A22NZ-3BL-NWA	A22NZ-3ML-NWA	A22NZ-3RL-NWA	A22NZ-3BR-NWA	A22NZ-3MR-NWA
	Automatic reset on left		A22NZ-3BB-NWA										
	3		Manual		A22NZ-2BM-NAA	A22NZ-2MM-NAA	A22NZ-2RM-NAA						
			Automatic reset on left		A22NZ-2BL-NAA	A22NZ-2ML-NAA	A22NZ-2RL-NAA						
			Automatic reset on left		A22NZ-3BM-NAA	A22NZ-3MM-NAA	A22NZ-3RM-NAA						
3	Manual		Opaque blue	Automatic reset on left	A22NZ-3BL-NAA	A22NZ-3ML-NAA	A22NZ-3RL-NAA	A22NZ-3BR-NAA	A22NZ-3MR-NAA	A22NZ-3RR-NAA	A22NZ-3BB-NAA	A22NZ-3MB-NAA	A22NZ-3RB-NAA
	Automatic reset on left												
	2			Manual	A22NZ-2BL-NBA	A22NZ-2ML-NBA	A22NZ-2RL-NBA						
				Automatic reset on left	A22NZ-3BM-NBA	A22NZ-3MM-NBA	A22NZ-3RM-NBA						
3	Manual			Opaque black	Automatic reset on left	A22NZ-3BL-NBA	A22NZ-3ML-NBA	A22NZ-3RL-NBA	A22NZ-3BR-NBA	A22NZ-3MR-NBA	A22NZ-3RR-NBA	A22NZ-3BB-NBA	A22NZ-3MB-NBA
	Automatic reset on left	A22NZ-2BM-NBA											
	2	Manual			A22NZ-2BL-NBA	A22NZ-2ML-NBA	A22NZ-2RL-NBA						
		Automatic reset on right			A22NZ-3BM-NBA	A22NZ-3MM-NBA	A22NZ-3RM-NBA						
		Automatic reset on left and right			A22NZ-3BL-NBA	A22NZ-3ML-NBA	A22NZ-3RL-NBA						
3	Manual	Opaque black			Automatic reset on right	A22NZ-3BR-NBA	A22NZ-3MR-NBA	A22NZ-3RR-NBA	A22NZ-3BB-NBA	A22NZ-3MB-NBA	A22NZ-3RB-NBA	A22NZ-2BM-NBA	A22NZ-2MM-NBA
	Automatic reset on right		A22NZ-2BL-NBA										
	2		Manual		A22NZ-3BM-NBA	A22NZ-3MM-NBA	A22NZ-3RM-NBA						
			Automatic reset on left and right		A22NZ-3BL-NBA	A22NZ-3ML-NBA	A22NZ-3RL-NBA						

■ Model numbers of sets: Refer to pages 6 to 8.

■ Specifications: Refer to page 14 and refer to the A22NN/A22NL.

■ Dimensions: Refer to page 15.

■ Accessories and tools: Refer to the A22NN/A22NL.

A22NS/A22NW

Ordering Information

Subassemblies - - - - You can order Operation Units, LED Lamps, Mounting Collars, and Contact Blocks individually. Use them in combination for models that are not available as assembled Switches. They can also be used as inventory for maintenance parts.

Lighted Switches

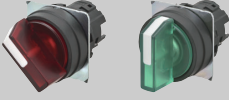
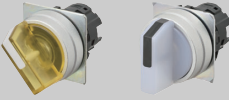
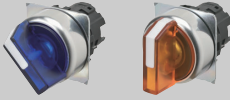
Bezel material and shape			Plastic	Brushed metal	Metal	
No. of positions	Reset method	Operation Unit color				
			Model	Model	Model	
2	Manual	Transparent red	A22NZ-2BM-TRA	A22NZ-2MM-TRA	A22NZ-2RM-TRA	
	Automatic reset on left		A22NZ-2BL-TRA	A22NZ-2ML-TRA	A22NZ-2RL-TRA	
3	Manual		A22NZ-3BM-TRA	A22NZ-3MM-TRA	A22NZ-3RM-TRA	
	Automatic reset on left		A22NZ-3BL-TRA	A22NZ-3ML-TRA	A22NZ-3RL-TRA	
	Automatic reset on right		A22NZ-3BR-TRA	A22NZ-3MR-TRA	A22NZ-3RR-TRA	
	Automatic reset on left and right		A22NZ-3BB-TRA	A22NZ-3MB-TRA	A22NZ-3RB-TRA	
2	Manual		Transparent green	A22NZ-2BM-TGA	A22NZ-2MM-TGA	A22NZ-2RM-TGA
	Automatic reset on left			A22NZ-2BL-TGA	A22NZ-2ML-TGA	A22NZ-2RL-TGA
3	Manual			A22NZ-3BM-TGA	A22NZ-3MM-TGA	A22NZ-3RM-TGA
	Automatic reset on left			A22NZ-3BL-TGA	A22NZ-3ML-TGA	A22NZ-3RL-TGA
	Automatic reset on right			A22NZ-3BR-TGA	A22NZ-3MR-TGA	A22NZ-3RR-TGA
	Automatic reset on left and right			A22NZ-3BB-TGA	A22NZ-3MB-TGA	A22NZ-3RB-TGA
2	Manual	Transparent yellow		A22NZ-2BM-TYA	A22NZ-2MM-TYA	A22NZ-2RM-TYA
	Automatic reset on left			A22NZ-2BL-TYA	A22NZ-2ML-TYA	A22NZ-2RL-TYA
3	Manual			A22NZ-3BM-TYA	A22NZ-3MM-TYA	A22NZ-3RM-TYA
	Automatic reset on left			A22NZ-3BL-TYA	A22NZ-3ML-TYA	A22NZ-3RL-TYA
	Automatic reset on right			A22NZ-3BR-TYA	A22NZ-3MR-TYA	A22NZ-3RR-TYA
	Automatic reset on left and right			A22NZ-3BB-TYA	A22NZ-3MB-TYA	A22NZ-3RB-TYA
2	Manual		Transparent white	A22NZ-2BM-TWA	A22NZ-2MM-TWA	A22NZ-2RM-TWA
	Automatic reset on left			A22NZ-2BL-TWA	A22NZ-2ML-TWA	A22NZ-2RL-TWA
3	Manual			A22NZ-3BM-TWA	A22NZ-3MM-TWA	A22NZ-3RM-TWA
	Automatic reset on left			A22NZ-3BL-TWA	A22NZ-3ML-TWA	A22NZ-3RL-TWA
	Automatic reset on right			A22NZ-3BR-TWA	A22NZ-3MR-TWA	A22NZ-3RR-TWA
	Automatic reset on left and right			A22NZ-3BB-TWA	A22NZ-3MB-TWA	A22NZ-3RB-TWA
2	Manual	Transparent blue		A22NZ-2BM-TAA	A22NZ-2MM-TAA	A22NZ-2RM-TAA
	Automatic reset on left			A22NZ-2BL-TAA	A22NZ-2ML-TAA	A22NZ-2RL-TAA
3	Manual			A22NZ-3BM-TAA	A22NZ-3MM-TAA	A22NZ-3RM-TAA
	Automatic reset on left			A22NZ-3BL-TAA	A22NZ-3ML-TAA	A22NZ-3RL-TAA
	Automatic reset on right			A22NZ-3BR-TAA	A22NZ-3MR-TAA	A22NZ-3RR-TAA
	Automatic reset on left and right			A22NZ-3BB-TAA	A22NZ-3MB-TAA	A22NZ-3RB-TAA
2	Manual		Transparent orange	A22NZ-2BM-TOA	A22NZ-2MM-TOA	A22NZ-2RM-TOA
	Automatic reset on left			A22NZ-2BL-TOA	A22NZ-2ML-TOA	A22NZ-2RL-TOA
3	Manual			A22NZ-3BM-TOA	A22NZ-3MM-TOA	A22NZ-3RM-TOA
	Automatic reset on left			A22NZ-3BL-TOA	A22NZ-3ML-TOA	A22NZ-3RL-TOA
	Automatic reset on right			A22NZ-3BR-TOA	A22NZ-3MR-TOA	A22NZ-3RR-TOA
	Automatic reset on left and right			A22NZ-3BB-TOA	A22NZ-3MB-TOA	A22NZ-3RB-TOA

■ Model numbers of sets: Refer to pages 6 to 8.

■ Specifications: Refer to page 14 and refer to the A22NN/A22NL.

■ Dimensions: Refer to page 15.

■ Accessories and tools: Refer to the A22NN/A22NL.

Ordering Information

Subassemblies --- You can order Operation Units, LED Lamps, Mounting Collars, and Contact Blocks individually. Use them in combination for models that are not available as assembled Switches. They can also be used as inventory for maintenance parts.

LED Lamps

Appearance	Applied voltage	6 VAC/DC	12 VAC/DC	24 VAC/DC	100/110/120 VAC	200/220/230/240 VAC
	Color	Model	Model	Model	Model	Model
	Red	A22NZ-L-RA	A22NZ-L-RB	A22NZ-L-RC	A22NZ-L-RD	A22NZ-L-RE
	Green	A22NZ-L-GA	A22NZ-L-GB	A22NZ-L-GC	A22NZ-L-GD	A22NZ-L-GE
	Yellow	A22NZ-L-YA	A22NZ-L-YB	A22NZ-L-YC	A22NZ-L-YD	A22NZ-L-YE
	White	A22NZ-L-WA	A22NZ-L-WB	A22NZ-L-WC	A22NZ-L-WD	A22NZ-L-WE
	Blue	A22NZ-L-AA	A22NZ-L-AB	A22NZ-L-AC	A22NZ-L-AD	A22NZ-L-AE
	Orange	A22NZ-L-OA	A22NZ-L-OB	A22NZ-L-OC	A22NZ-L-OD	A22NZ-L-OE

Mounting Collar

Appearance	Model
	A22NZ-H-01

Contact Blocks

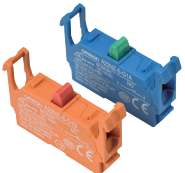
Appearance	Contacts	Model
	SPST-NO (blue)	A22NZ-S-G1A
	SPST-NC (orange)	A22NZ-S-G1B

Lighting Units

Appearance	Applied voltage	Model
	6 VAC/DC	A22NZ-T-A
	12 VAC/DC	A22NZ-T-B
	24 VAC/DC	A22NZ-T-C
	100/110/120 VAC	A22NZ-T-D
	200/220/230/240 VAC	A22NZ-T-E

Reinforcement Plate

Appearance	Model
	A22NZ-A-C01

■ Model numbers of sets: Refer to pages 6 to 8.

■ Specifications: Refer to page 14 and refer to the A22NN/A22NL.

■ Dimensions: Refer to page 15.

■ Accessories and tools: Refer to the A22NN/A22NL.

Specifications

Characteristics

Item	Type	Selector Switches	
		Non-lighted models	Lighted models
Allowable operating frequency	Mechanical	30 operations/minute max.	
	Electrical	30 operations/minute max.	
Insulation resistance		100 MΩ min. (at 500 VDC)	
Contact resistance		100 mΩ max. (initial value)	
Dielectric strength	Between terminals of same polarity	2,500 VAC at 50/60 Hz for 1 min	
	Between each terminal and ground	2,500 VAC at 50/60 Hz for 1 min	
Vibration resistance	Malfunction	10 to 55 Hz, 1.5-mm double amplitude (malfunction within 1 ms)	
Shock resistance	Malfunction	1,000 m/s ² max. (malfunction within 1 ms)	
Durability	Mechanical	500,000 operations min. (Switches with 3 positions: 300,000 operations min.)	
	Electrical	500,000 operations min. (Switches with 3 positions: 300,000 operations min.)	
Ambient operating temperature ^{*1}		-25 to 70°C	-25 to 55°C
Ambient operating humidity		35% to 85% RH	
Ambient storage temperature ^{*1}		-40 to 80°C	
Degree of protection ^{*2}		IP66, NEMA 4X, NEMA 13	
Electric shock protection class		Class II	
PTI (tracking characteristic)		175	
Degree of contamination (application environment)		3 (IEC 60947-5-1)	
Weight		Approx. 50 g (for 1NC/1NO)	Approx. 60 g (for 1NC/1NO)

*1. With no icing or condensation.

*2. Degree of protection from the front of the panel.

Operating Characteristics (for SPST-NO/SPST-NC)

Item	Type	Selector Switches	
		Manual reset	Automatic reset
Total travel force (torque) (maximum TTF)		0.6 N·m	0.6 N·m
Total travel (TT)		2 positions: Approx. 90°, 3 positions: Approx. 45°	
Resetting force (torque) (RF)		0.5 N·m max.	---

Examples of Linked Contact Blocks

Contact Blocks Lighting Units

	Selector Switches			
	2 positions		3 positions	
	Lighted	Non-lighted	Lighted	Non-lighted
Linking example				

* If you use three Contact Blocks in stage 1, you can add one more Contact Block in the middle of stage 2.

Note: If you increase the number of Contact Blocks, evaluate the Switch under actual working conditions before permanent installation and use the Switch within a number of switching operations that will not adversely affect the Switch's performance.

Dimensions

(Unit: mm)

Lighted and Non-lighted Selection Switches

Two-position Switches with Plastic Bezels

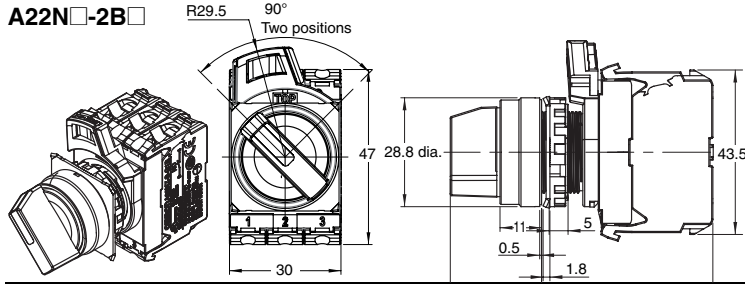

Three-position Switches with Plastic Bezels

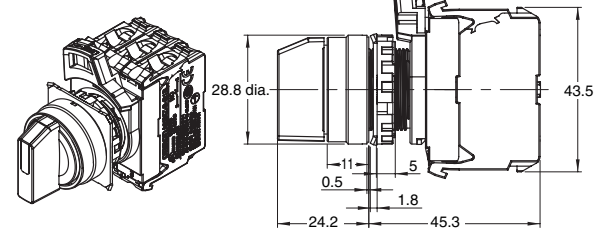

Two-position Switches with Brushed Metal Bezels

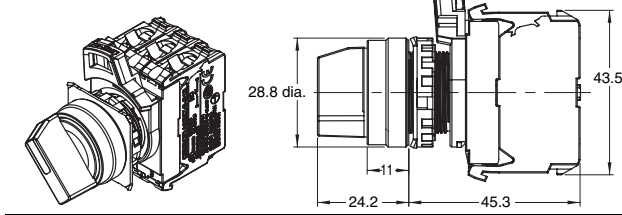

Three-position Switches with Brushed Metal Bezel:

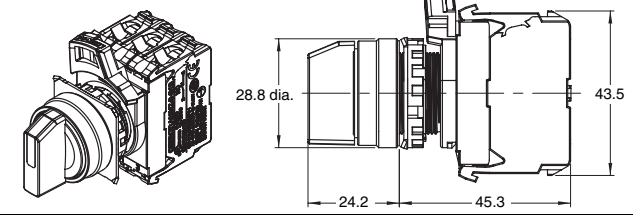

Two-position Switches with Metal Bezels

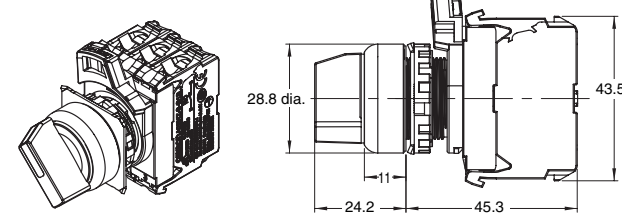

Three-position Switches with Metal Bezels

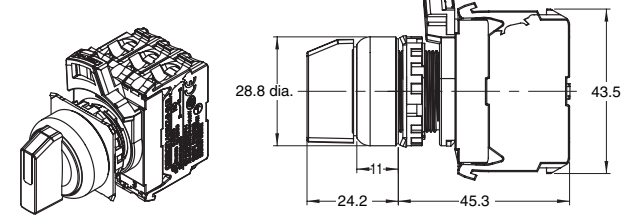

Depth with Linked Units

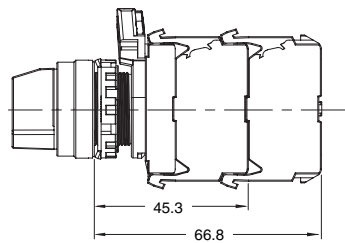

Terminal Wiring Diagrams

Bottom View

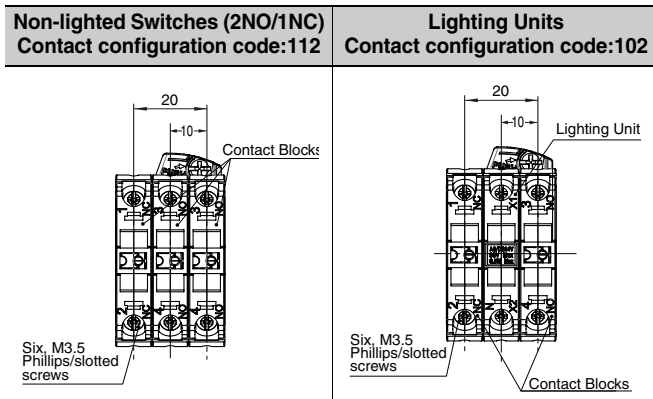

Terminal Connection Diagrams

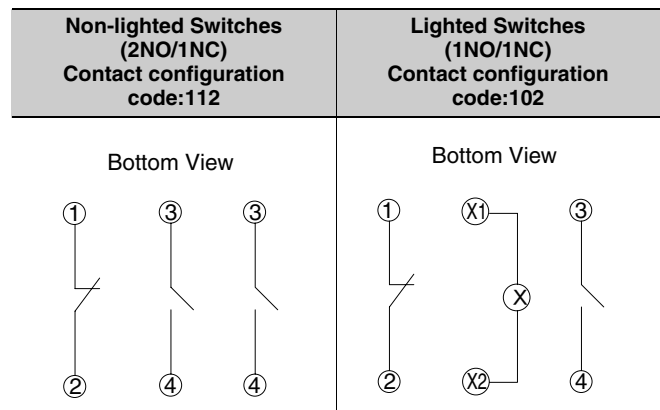

Safety Precautions

Refer to *Safety Precautions for All Pushbutton Switches/Indicators* for common precautions.
Read the *Safety Precautions* on the following pages.

Safety Precautions

Refer to Safety Precautions for All Pushbutton Switches/Indicators.

Precautions for Safe Use

- Never perform wiring work on a Switch while power is being supplied. Never touch terminals and other charged parts while power is being supplied. Doing so may result in electrical shock.
- Never attempt to disassemble or modify the Switch in any way. Doing so may prevent correct operation.
- Switch functionality may be inhibited. Do not drop the Switch. Never apply a force that would deform or alter the nature of the Switch.
- The durability of the Switch is greatly affected by operating conditions. Evaluate the Switch under actual working conditions before permanent installation and use the Switch within a number of switching operations that will not adversely affect the Switch's performance.
- Do not use a load voltage or current that exceeds the rating. Doing so may damage or cause burning in the Switch.
- Do not use the Switch in a location with inflammable or explosive gases, or where the Switch would be subjected to inflammable solvents. The arcs and heat generated when the Switch is operated can cause ignition or explosions.
- Do not use the Switch where sulfur gas (H₂S, SO₂), ammonia gas (NH₃), nitric acid gas (HNO₃), chlorine gas (Cl₂), or other harmful gases are present or where high humidity is present. Contact faults and damage due to corrosion may interfere with the functionality of the Switch.
- Do not use the Switch in oil or water or in an environment subject to constant contact with oil or water. The oil or water may enter the Switch, causing failure.
- Do not use or store the Switch in the following locations.
 - Locations subject to rapid temperature changes
 - Locations subject to condensation due to high humidity
 - Locations subject to vibration
 - Locations subject to direct sunlight
 - Locations subject to salty air
- Make sure that the rubber washer is in place between the Operation Unit and the panel. Otherwise, the specifications of the protective structure may not be satisfied.
- Do not subject the Contact Block or wiring to excessive force. The Contact Block may be damaged or deformed and faulty contact may occur.

Precautions for Correct Use

Mounting

- Do not tighten the Mounting Nut more than necessary using tools such as pointed-nose pliers. Doing so will damage the Mounting Nut. (The tightening torque of the Mounting Nut is 1.0 to 2.0 N·m.)

Wiring

- Terminal screws must be M3.5 Phillips or slotted screws with a square washer.
- The terminal screw tightening torque is 1.0 to 1.3 N·m.
- Solid wires, stranded wires, and crimp terminals can be connected to the Switch.

Stranded wires: AWG14 to AWG16

Solid wire: 1.6 dia. max.

Bare Crimp Terminals

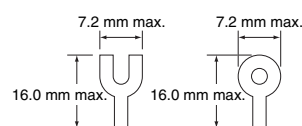

Crimp Terminals with Insulating Sheaths

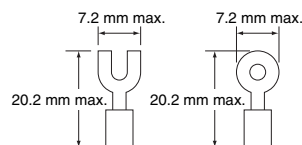

- After wiring the Switch, maintain appropriate clearance and creepage distances.

Operating Environment

- The Switch is intended for indoor use only. Using the Switch outdoors will result in failure.

LED Lamps

- A current-limiting resistor is built into the LED Lamp, so external resistance is not required.
- False Lighting of the LED Lamp
The LED Lamp will light with a microcurrent of approx. 0.1 mA or less. Take countermeasures, such as adding a resistor in parallel to the LED Lamp, to prevent false lighting.
The micro-current varies with the machine (due to leakage current, stray capacity between cables, etc.). Select a resistance value and allowable power consumption according to the actual current.

Example of Circuit to Prevent False Lighting

For 24 VAC/VDC Lighting Unit

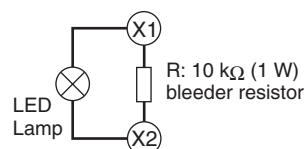

Application

Mounting to the Panel

Panel Hole Dimensions

- Panel hole dimensions are given below.
- The recommended panel thicknesses are given below.

Panel hole dimension	Panel thickness
22.3 dia.	0.8 to 5 mm
25.5 dia.	0.8 to 6 mm

- If outer surface treatment such as coating is performed for the panel, the panel dimensions after outer surface treatment must meet the specified panel dimensions.
- The following figure gives pitch dimension A and pitch dimension B between the centers of the mounting holes.

Panel Hole Dimensions for 22.3 Diameter

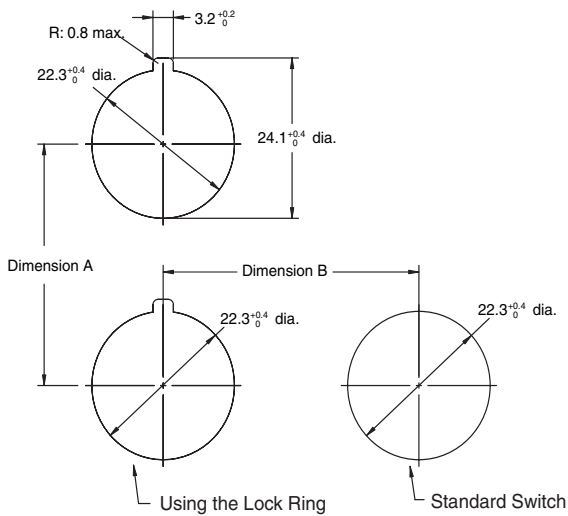

Panel Hole Dimensions for 25.5 Diameter

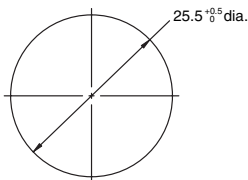

Dimension A

Wire type	Number of linked Contact Blocks	Number of wires per terminal	Minimum allowable pitch Dimension A (mm) or larger
Leads (twisted wires or solid wire)	1	1	50
Bare crimp terminals	1	1	50
Crimp terminals with insulating sheathes	1	1	60

Note: The minimum mounting pitch is based on three Contact Blocks in stage 1 with one wire attached to each terminal. If you attach two wires or link Units, determine the mounting pitch based on the dimensions diagrams and ease of operation and wiring.

Dimension A When Using Accessory

- Dimension A is 50 mm minimum when a Standard Legend Plate Frame is attached.
- Dimension A is 51 mm minimum when a Large Legend Plate Frame is attached.
- Dimension A is 75 mm minimum when a Protective Cover is attached.

Dimension B

Operation Unit shape	Dimension B
Mushroom	40 mm min.
Other than the above	30 mm min.

Mounting the Operation Unit

- **Panel Hole of 22.3-mm Diameter**
Insert the Operation Unit from the front of the panel, insert the Lock Ring and Mounting Nut from the back of the panel, and tighten the Mounting Nut. Before tightening, check that the rubber washer is present between the Operation Unit and the panel.

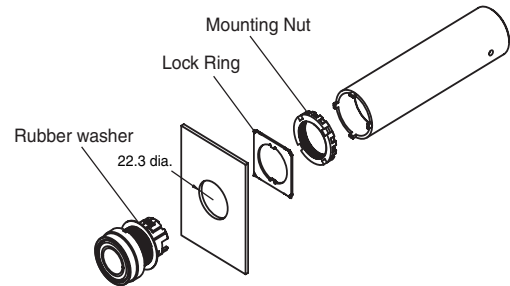

- **Panel Hole of 25.5-mm Diameter**
Do not use the Lock Ring, and tighten the Mounting Nut while confirming that the projecting part (see following figure) on the Mounting Nut is aligned with mounting hole. Before tightening, check that the rubber washer is present between the Operation Unit and the panel.

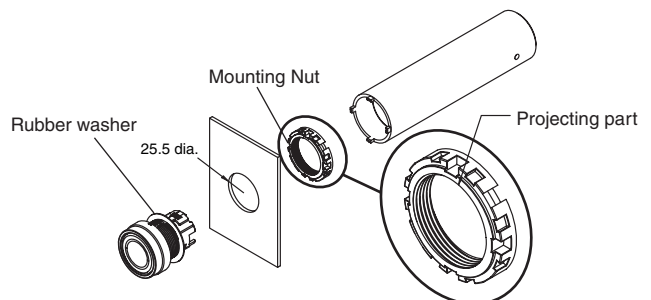

- Align the Lock Ring with the slot on the case and insert it so that the edge is flush with the panel.

Mounting the Contact Block to the Operation Unit

- Insert the Operation Unit into the Mounting Collar, aligning the TOP mark inscribed on the Operation Unit with the lever on the Mounting Collar, and then turn the lever in the direction indicated by the arrow in the following figure all of the way until it clicks into place.

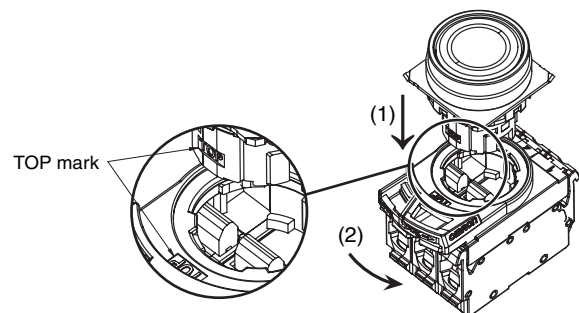

Removing the Mounting Collar

- Press the lock lever in from the back side to release the lock, and then hook the Mounting Collar with a screwdriver, move it in the direction indicated at (2), and remove it. Turn the lever all of the way until it clicks into place.

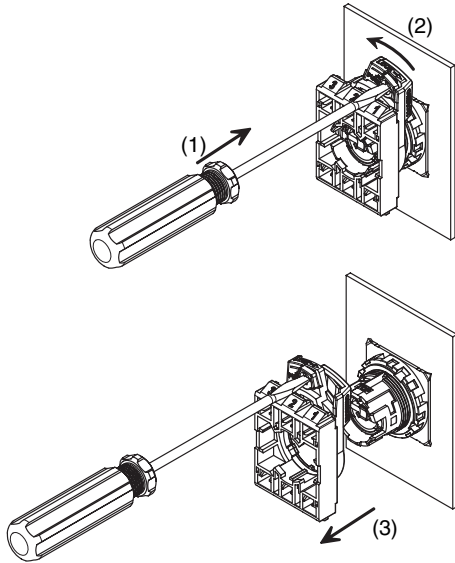

Contact Block

Attaching the Contact Block

- Catch the projection on the opposite side of the Mounting Collar from the lever side and press the Contact Block in the direction indicated at (1).

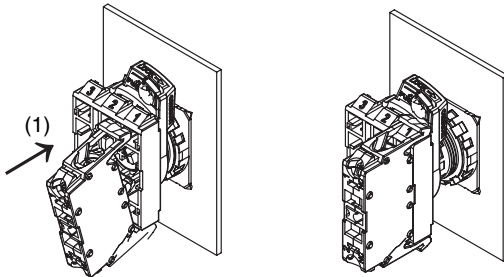

Removing the Contact Block

- Insert a screwdriver into the gap between the Mounting Collar and Contact Block and press it inward in the direction shown at (2).

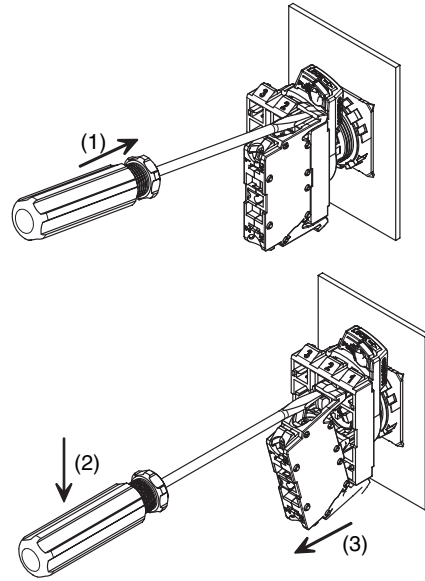

Attaching the Reinforcement Plate

- To link Contact Blocks together, attach a Reinforcement Plate in the direction shown in the following figure. To remove the Plate, insert a screwdriver in the direction indicated at (1) and rotate it in the direction indicated at (2).

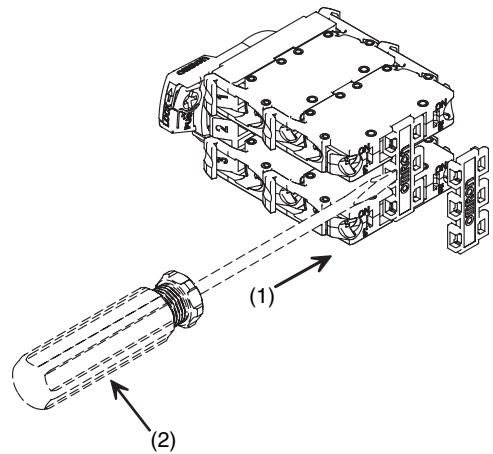

Engraving

- Engrave legends on the Legend Plates. Do so with the straight part of the Legend Plate positioned on the right and left.
- The characters must be engraved no deeper than 0.5 mm. Use an alcohol-based paint, such as a melamine, phthalic acid, or acrylic resin based paint.

Projected, Full-guard, or Mushroom Switches	Flat Switches
 15.4 dia.	 17.7 dia.

Attaching Character Films

- To attach a character film, remove the Button and attach the film, aligning it with the straight portions of the Legend Plate.

Projected Switches

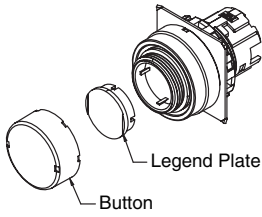

Full-guard Switches

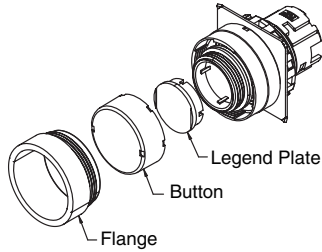

Mushroom Switches

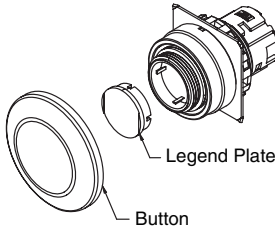

Flat Switches

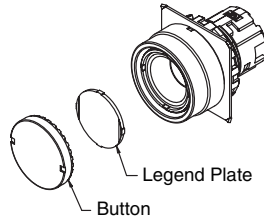

- Prepare films of the following sizes depending on the type of Legend Plate.

Projected, Full-guard, or Mushroom Switches	Legend Plate dimensions	
	Film dimensions	
Flat Switches	Legend Plate dimensions	
	Film dimensions	

Removing and Tightening the Cap

For all Switches except for Mushroom Switches, use the A22Z-3908 Cap Tightening Tool to loosen the cap. When you tighten the cap, make sure that the Legend Plate is in the correct position and then turn the cap in the direction opposite of the direction shown in the following figure. Tighten it to a torque of 0.5 to 1.0 N·m so that it will not become loose.

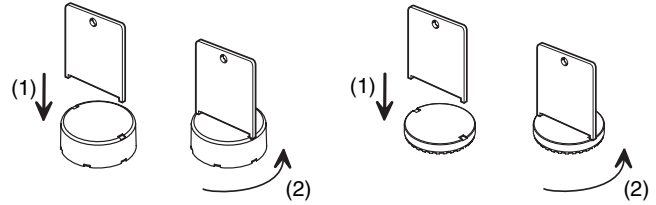

Attaching the LED Lamp to the Lighting Unit

- Insert the protrusions on the LED Lamp into the guides on the Lighting Unit and then turn the LED Lamp in direction (2) to lock it in place.

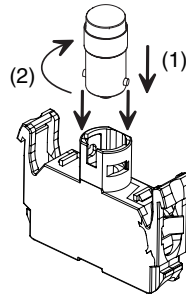

Attaching and Replacing LED Lamps

Removing the LED Lamp from the Panel Surface

- Insert the LED Lamp Extractor as shown in the following figure and then rotate the Extractor in the direction shown at (2) while pressing it inward.

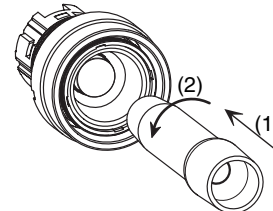

Attaching the LED Lamp from the Panel Surface

- Insert the LED Lamp into the LED Lamp Extractor as shown in the following figure. Align the projections on the LED Lamp with the LED Lamp insertion guides, insert the LED Lamp, and turn it in the direction indicated at (2).

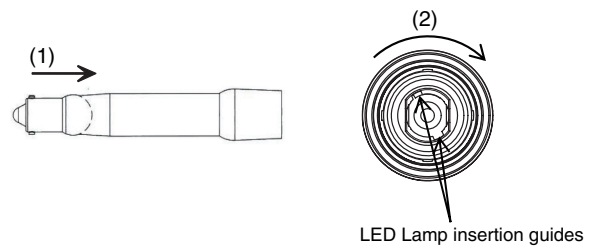

Control Box

You can attach a Legend Plate Frame.
 Attach it in the direction shown in the following figure.
 Mount the Switch in the same way as for a standard panel. The tightening torque of the Box screws is 1.4 to 2.0 N·m.

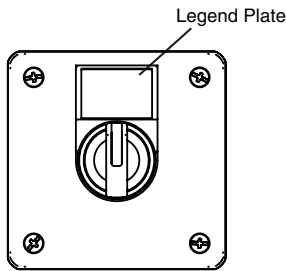

Creating a Cable Hole

To open a cable hole, leave the cover attached, place the tip of a screwdriver in the grooves at four locations around the cable hole, and strike the screwdriver with a hammer to open the hole.

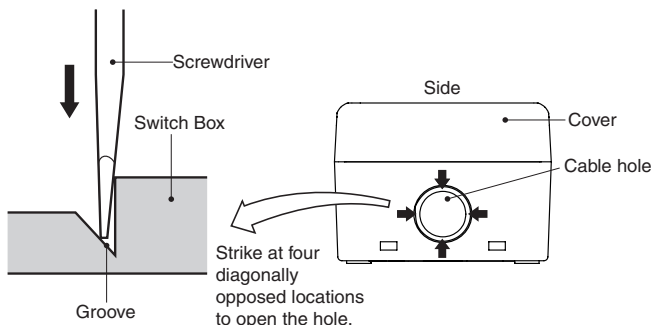

Attaching and Removing Legend Plates

- Press the Legend Plate into the depression in the Legend Plate Frame. The Legend Plate Frame can be separate or it can be mounted on the panel when you attach the Legend Plate.
- The direction of the characters will depend on the mounting direction of the Operation Unit if the Switch is a Selector Switch or Key Selector Switch.

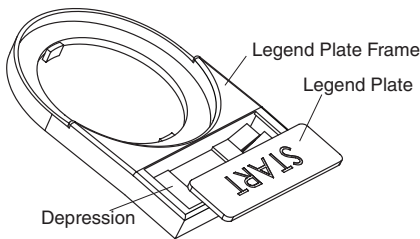

- You can easily remove the Legend Plate by pressing it forwards from the back of the Legend Plate Frame.
- The acrylic plastic Legend Plate is easily damaged by shock. Handle it with care.

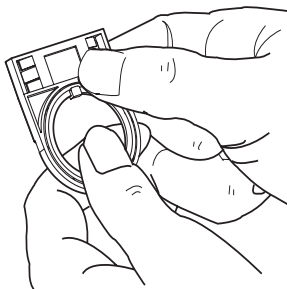

Attaching the Lock Ring

Attach the Lock Ring as shown in the following figure.
 To ensure water resistance, attach the rubber washer in the specified location.

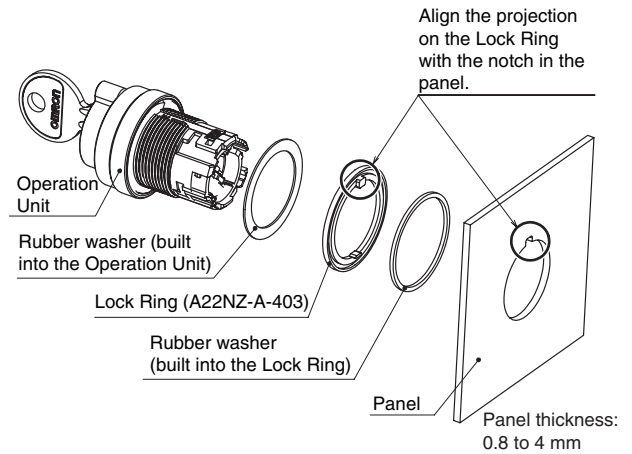

- Align the TOP mark on the Operation Unit, part A on the Legend Plate, and the notch in the panel, and insert the Operation Unit.

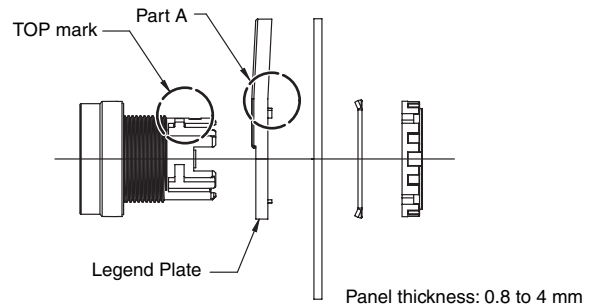

- If there is no notch in the panel, remove part A from the Legend Plate with pliers.

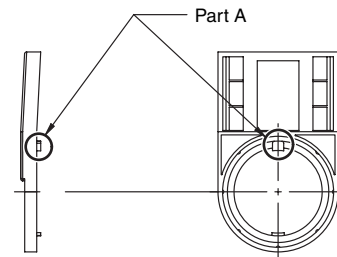

Attaching the Protective Cover

Attach the Protective Cover (A22NZ-A-303) to a panel that is 0.8 to 1.0 mm thick. To ensure water resistance, attach the rubber washer in the specified location.

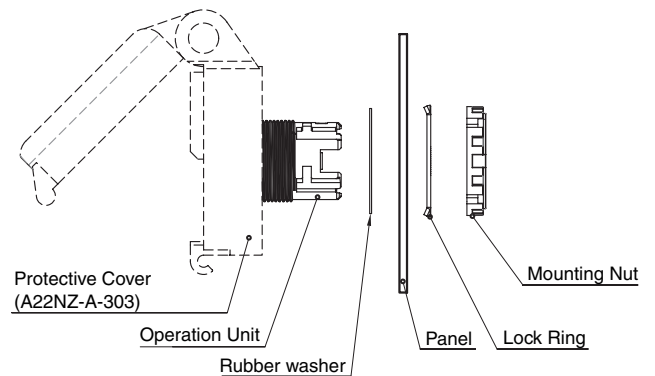

Terms and Conditions of Sale

1. **Offer; Acceptance.** These terms and conditions (these "**Terms**") are deemed part of all quotes, agreements, purchase orders, acknowledgments, price lists, catalogs, manuals, brochures and other documents, whether electronic or in writing, relating to the sale of products or services (collectively, the "**Products**") by Omron Electronics LLC and its subsidiary companies ("**Omron**"). Omron objects to any terms or conditions proposed in Buyer's purchase order or other documents which are inconsistent with, or in addition to, these Terms.
2. **Prices; Payment Terms.** All prices stated are current, subject to change without notice by Omron. Omron reserves the right to increase or decrease prices on any unshipped portions of outstanding orders. Payments for Products are due net 30 days unless otherwise stated in the invoice.
3. **Discounts.** Cash discounts, if any, will apply only on the net amount of invoices sent to Buyer after deducting transportation charges, taxes and duties, and will be allowed only if (i) the invoice is paid according to Omron's payment terms and (ii) Buyer has no past due amounts.
4. **Interest.** Omron, at its option, may charge Buyer 1-1/2% interest per month or the maximum legal rate, whichever is less, on any balance not paid within the stated terms.
5. **Orders.** Omron will accept no order less than \$200 net billing.
6. **Governmental Approvals.** Buyer shall be responsible for, and shall bear all costs involved in, obtaining any government approvals required for the importation or sale of the Products.
7. **Taxes.** All taxes, duties and other governmental charges (other than general real property and income taxes), including any interest or penalties thereon, imposed directly or indirectly on Omron or required to be collected directly or indirectly by Omron for the manufacture, production, sale, delivery, importation, consumption or use of the Products sold hereunder (including customs duties and sales, excise, use, turnover and license taxes) shall be charged to and remitted by Buyer to Omron.
8. **Financial.** If the financial position of Buyer at any time becomes unsatisfactory to Omron, Omron reserves the right to stop shipments or require satisfactory security or payment in advance. If Buyer fails to make payment or otherwise comply with these Terms or any related agreement, Omron may (without liability and in addition to other remedies) cancel any unshipped portion of Products sold hereunder and stop any Products in transit until Buyer pays all amounts, including amounts payable hereunder, whether or not then due, which are owing to it by Buyer. Buyer shall in any event remain liable for all unpaid accounts.
9. **Cancellation; Etc.** Orders are not subject to rescheduling or cancellation unless Buyer indemnifies Omron against all related costs or expenses.
10. **Force Majeure.** Omron shall not be liable for any delay or failure in delivery resulting from causes beyond its control, including earthquakes, fires, floods, strikes or other labor disputes, shortage of labor or materials, accidents to machinery, acts of sabotage, riots, delay in or lack of transportation or the requirements of any government authority.
11. **Shipping; Delivery.** Unless otherwise expressly agreed in writing by Omron:
 - a. Shipments shall be by a carrier selected by Omron; Omron will not drop ship except in "break down" situations.
 - b. Such carrier shall act as the agent of Buyer and delivery to such carrier shall constitute delivery to Buyer;
 - c. All sales and shipments of Products shall be FOB shipping point (unless otherwise stated in writing by Omron), at which point title and risk of loss shall pass from Omron to Buyer; provided that Omron shall retain a security interest in the Products until the full purchase price is paid;
 - d. Delivery and shipping dates are estimates only; and
 - e. Omron will package Products as it deems proper for protection against normal handling and extra charges apply to special conditions.
12. **Claims.** Any claim by Buyer against Omron for shortage or damage to the Products occurring before delivery to the carrier must be presented in writing to Omron within 30 days of receipt of shipment and include the original transportation bill signed by the carrier noting that the carrier received the Products from Omron in the condition claimed.
13. **Warranties.** (a) **Exclusive Warranty.** Omron's exclusive warranty is that the Products will be free from defects in materials and workmanship for a period of twelve months from the date of sale by Omron (or such other period expressed in writing by Omron). Omron disclaims all other warranties, express or implied. (b) **Limitations.** OMRON MAKES NO WARRANTY OR REPRESENTATION, EXPRESS OR IMPLIED, ABOUT NON-INFRINGEMENT, MERCHANTABILITY OR FITNESS FOR A PARTICULAR PURPOSE OF THE PRODUCTS. BUYER ACKNOWLEDGES THAT IT ALONE HAS DETERMINED THAT THE PRODUCTS WILL SUITABLY MEET THE REQUIREMENTS OF THEIR INTENDED USE. Omron further disclaims all warranties and responsibility of any type for claims or expenses based on infringement by the Products or otherwise of any intellectual property right. (c) **Buyer Remedy.** Omron's sole obligation hereunder shall be, at Omron's election, to (i) replace (in the form originally shipped with Buyer responsible for labor charges for removal or replacement thereof) the non-complying Product, (ii) repair the non-complying Product, or (iii) repay or credit Buyer an amount equal to the purchase price of the non-complying Product; provided that in no event shall Omron be responsible for warranty, repair, indemnity or any other claims or expenses regarding the Products unless Omron's analysis confirms that the Products were properly handled, stored, installed and maintained and not subject to contamination, abuse, misuse or inappropriate modification. Return of any Products by Buyer must be approved in writing by Omron before shipment. Omron Companies shall not be liable for the suitability or unsuitability or the results from the use of Products in combination with any electrical or electronic components, circuits, system assemblies or any other materials or substances or environments. Any advice, recommendations or information given orally or in writing, are not to be construed as an amendment or addition to the above warranty. See <http://www.omron247.com> or contact your Omron representative for published information.
14. **Limitation on Liability; Etc.** OMRON COMPANIES SHALL NOT BE LIABLE FOR SPECIAL, INDIRECT, INCIDENTAL, OR CONSEQUENTIAL DAMAGES, LOSS OF PROFITS OR PRODUCTION OR COMMERCIAL LOSS IN ANY WAY CONNECTED WITH THE PRODUCTS, WHETHER SUCH CLAIM IS BASED IN CONTRACT, WARRANTY, NEGLIGENCE OR STRICT LIABILITY. Further, in no event shall liability of Omron Companies exceed the individual price of the Product on which liability is asserted.
15. **Indemnities.** Buyer shall indemnify and hold harmless Omron Companies and their employees from and against all liabilities, losses, claims, costs and expenses (including attorney's fees and expenses) related to any claim, investigation, litigation or proceeding (whether or not Omron is a party) which arises or is alleged to arise from Buyer's acts or omissions under these Terms or in any way with respect to the Products. Without limiting the foregoing, Buyer (at its own expense) shall indemnify and hold harmless Omron and defend or settle any action brought against such Companies to the extent based on a claim that any Product made to Buyer specifications infringed intellectual property rights of another party.
16. **Property; Confidentiality.** Any intellectual property in the Products is the exclusive property of Omron Companies and Buyer shall not attempt to duplicate it in any way without the written permission of Omron. Notwithstanding any charges to Buyer for engineering or tooling, all engineering and tooling shall remain the exclusive property of Omron. All information and materials supplied by Omron to Buyer relating to the Products are confidential and proprietary, and Buyer shall limit distribution thereof to its trusted employees and strictly prevent disclosure to any third party.
17. **Export Controls.** Buyer shall comply with all applicable laws, regulations and licenses regarding (i) export of products or information; (ii) sale of products to "forbidden" or other proscribed persons; and (iii) disclosure to non-citizens of regulated technology or information.
18. **Miscellaneous.** (a) **Waiver.** No failure or delay by Omron in exercising any right and no course of dealing between Buyer and Omron shall operate as a waiver of rights by Omron. (b) **Assignment.** Buyer may not assign its rights hereunder without Omron's written consent. (c) **Law.** These Terms are governed by the law of the jurisdiction of the home office of the Omron company from which Buyer is purchasing the Products (without regard to conflict of law principles). (d) **Amendment.** These Terms constitute the entire agreement between Buyer and Omron relating to the Products, and no provision may be changed or waived unless in writing signed by the parties. (e) **Severability.** If any provision hereof is rendered ineffective or invalid, such provision shall not invalidate any other provision. (f) **Setoff.** Buyer shall have no right to set off any amounts against the amount owing in respect of this invoice. (g) **Definitions.** As used herein, "including" means "including without limitation"; and "Omron Companies" (or similar words) mean Omron Corporation and any direct or indirect subsidiary or affiliate thereof.

Certain Precautions on Specifications and Use

1. **Suitability of Use.** Omron Companies shall not be responsible for conformity with any standards, codes or regulations which apply to the combination of the Product in the Buyer's application or use of the Product. At Buyer's request, Omron will provide applicable third party certification documents identifying ratings and limitations of use which apply to the Product. This information by itself is not sufficient for a complete determination of the suitability of the Product in combination with the end product, machine, system, or other application or use. Buyer shall be solely responsible for determining appropriateness of the particular Product with respect to Buyer's application, product or system. Buyer shall take application responsibility in all cases but the following is a non-exhaustive list of applications for which particular attention must be given: (i) Outdoor use, uses involving potential chemical contamination or electrical interference, or conditions or uses not described in this document. (ii) Use in consumer products or any use in significant quantities. (iii) Energy control systems, combustion systems, railroad systems, aviation systems, medical equipment, amusement machines, vehicles, safety equipment, and installations subject to separate industry or government regulations. (iv) Systems, machines and equipment that could present a risk to life or property. Please know and observe all prohibitions of use applicable to this Product. NEVER USE THE PRODUCT FOR AN APPLICATION INVOLVING SERIOUS RISK TO LIFE OR PROPERTY OR IN LARGE QUANTITIES WITHOUT ENSURING THAT THE SYSTEM AS A WHOLE HAS BEEN DESIGNED TO ADDRESS THE RISKS, AND THAT THE OMRON'S PRODUCT IS PROPERLY RATED AND INSTALLED FOR THE INTENDED USE WITHIN THE OVERALL EQUIPMENT OR SYSTEM.
2. **Programmable Products.** Omron Companies shall not be responsible for the user's programming of a programmable Product, or any consequence thereof.
3. **Performance Data.** Data presented in Omron Company websites, catalogs and other materials is provided as a guide for the user in determining suitability and does not constitute a warranty. It may represent the result of Omron's test conditions, and the user must correlate it to actual application requirements. Actual performance is subject to the Omron's Warranty and Limitations of Liability.
4. **Change in Specifications.** Product specifications and accessories may be changed at any time based on improvements and other reasons. It is our practice to change part numbers when published ratings or features are changed, or when significant construction changes are made. However, some specifications of the Product may be changed without any notice. When in doubt, special part numbers may be assigned to fix or establish key specifications for your application. Please consult with your Omron's representative at any time to confirm actual specifications of purchased Product.
5. **Errors and Omissions.** Information presented by Omron Companies has been checked and is believed to be accurate; however, no responsibility is assumed for clerical, typographical or proofreading errors or omissions.

OMRON AUTOMATION AND SAFETY • THE AMERICAS HEADQUARTERS • Chicago, IL USA • 847.843.7900 • 800.556.6766 • www.omron247.com

OMRON CANADA, INC. • HEAD OFFICE

Toronto, ON, Canada • 416.286.6465 • 866.986.6766 • www.omron247.com

OMRON ELECTRONICS DE MEXICO • HEAD OFFICE

México DF • 52.55.59.01.43.00 • 01-800-226-6766 • mela@omron.com

OMRON ELECTRONICS DE MEXICO • SALES OFFICE

Apodaca, N.L. • 52.81.11.56.99.20 • 01-800-226-6766 • mela@omron.com

OMRON ELETRÔNICA DO BRASIL LTDA • HEAD OFFICE

São Paulo, SP, Brasil • 55.11.2101.6300 • www.omron.com.br

OMRON ARGENTINA • SALES OFFICE

Cono Sur • 54.11.4783.5300

OMRON CHILE • SALES OFFICE

Santiago • 56.9.9917.3920

OTHER OMRON LATIN AMERICA SALES

54.11.4783.5300

OMRON EUROPE B.V. • Wegalaan 67-69, NL-2132 JD, Hoofddorp, The Netherlands. • +31 (0) 23 568 13 00 • www.industrial.omron.eu

Authorized Distributor:

Automation Control Systems

- Machine Automation Controllers (MAC) • Programmable Controllers (PLC)
- Operator interfaces (HMI) • Distributed I/O • Software

Drives & Motion Controls

- Servo & AC Drives • Motion Controllers & Encoders

Temperature & Process Controllers

- Single and Multi-loop Controllers

Sensors & Vision

- Proximity Sensors • Photoelectric Sensors • Fiber-Optic Sensors
- Amplified Photomicrosensors • Measurement Sensors
- Ultrasonic Sensors • Vision Sensors

Industrial Components

- RFID/Code Readers • Relays • Pushbuttons & Indicators
- Limit and Basic Switches • Timers • Counters • Metering Devices
- Power Supplies

Safety

- Laser Scanners • Safety Mats • Edges and Bumpers • Programmable Safety Controllers • Light Curtains • Safety Relays • Safety Interlock Switches