

IMI Norgren Ecology Seal...

Where Cylinder Speed meets Quieter Cycles

The Ecology seal, in conjunction with a fixed cushion, provides faster and quieter cycles, without the undesirable high impact forces at the end of stroke!

The Ecology Seal is designed to work in conjunction with standard air cushion technology, and contributes up to 80% of the deceleration required at the end of stroke.



IMI Norgren Ecology Seal Benefits

Machine Reliability

Eliminates end of stroke impact forces, reducing vibration and component failures
Eliminate potential pneumatic bounce

Increased Productivity

Travel at higher speeds
Up to 75% less travel time through cushion (25ms versus 100ms)
Pre-engineered fixed cushion means no cushion screw to be adjusted or tampered with
Reduce down time

Reduce System Costs

Eliminate flow controls
Ecology seal cylinder with fixed cushions is less expensive than conventional cushioned cylinder
Reduce cylinder bore size
Reduce set up time

Safe Work Environment

Noise reduction - meets OSHA specifications
Reduced equipment failures, minimizing injury risk

Industry Conformance

Conforms to industry standard dimensions, does not add length
Available in FPM
Widely proven and desired throughout the industry

"By eliminating the cushion needle, the Ecology Seal Cylinder saves us 1-1/2 hours set up per machine." - A leading packaging OEM

IMI Norgren Ecology Seal - How Does it Work?

The Ecology seal is a Nitrile material and designed for two functions.

- 1) It is a pressure compensating lip-type piston seal and performs as such throughout the stroke.
- 2) It's a dampening material for superior deceleration of the piston through the final increments of stroke.



The air cushion starts the deceleration process. As the cylinder traverses towards the end of stroke, the exhausting air is free flowing through an unrestricted passage.



As the cushion spear enters the end cap, it blocks the free flowing path. The exhausting air is then forced through a very small, controlled orifice.



As the cylinder continues towards the end of stroke, the volume of air decreases, compressing the exhausting air. The exhausting air compresses to a high level, providing the deceleration force to slow the cylinder. The size of this controlled cushion orifice determines the rate of deceleration generated by the air cushion.



As the cylinder approaches the final stroke, the Ecology seal comes in contact with the end cap of the cylinder. The Ecology seal material is non-compressible, however, at full pressure, it is designed to move or deform in shape to allow the cylinder to achieve full stroke. The force required to deform this material is the final deceleration force used to bring the cylinder to a nice, smooth stop.



The Ecology seal also acts as a spring to assist in a quick release out of cushion as the cylinder initiates the traverse in the opposite direction.

Ecology Test Data Examples

Compare Ecology Cylinders with Fixed cushions to cylinders with Adjustable cushions. Ecology cylinders yield less time through cushion and less bounce!

ECOLOGY CYLINDERS with Non-Adjustable Cushions

2" Bore Rod End Cushion Test

Average deceleration force = 15 G's
Time consumed during cushioning = 0.030 sec.
Number of bounces: 1 Pneumatic – 1 Metallic

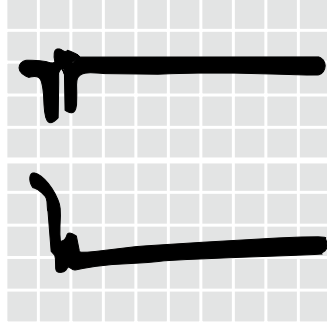

Acceleration:
1 div. = 10 G's
X Axis: 1 div. = .03
seconds

Velocity:
1 div. =
20 in/sec.
14.5 lbs. added
to rod

ECOLOGY CYLINDERS with Adjustable Cushions

2" Bore Rod End Cushion Test

Average deceleration force = 20 G's
Time consumed during cushioning = 0.015 sec.
Number of bounces: 1/2 Pneumatic – 0 Metallic

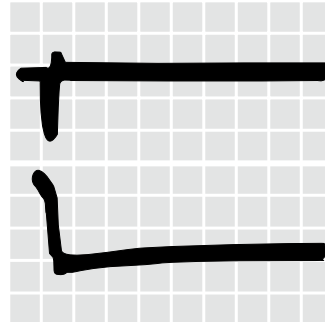

Acceleration: 1
div. = 10 G's
X Axis: 1 div. =
.03 seconds

Velocity:
1 div. =
20 in/sec.
2.5 lbs.
added to rod

COMPETITIVE CYLINDERS with Adjustable Cushions

2" Bore Rod End Cushion Test

Average deceleration force = 78 G's
Time consumed during cushioning = 0.120 sec.
Number of bounces: 2 Pneumatic – 4 Metallic

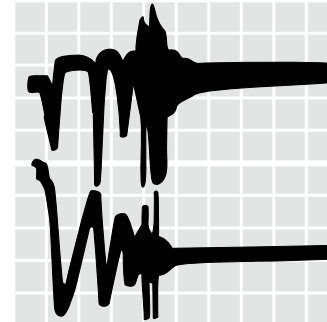

Acceleration:
1 div. = 10 G's
X Axis: 1 div. =
.03 seconds

Velocity:
1 div. =
20 in/sec.
14.5 lbs.
added to rod



Hear the difference between Ecology seal cylinders with fixed cushions and non-cushioned cylinders!

Ecology Seal Application Tips Use an Ecology Seal Cylinder...

- > When excess machine vibration due to pneumatic components is a concern
- > To reduce noise levels
- > When load deceleration is a concern
- > When cushions are required, but speed cannot be sacrificed
- > And eliminate flow controls
- > Because traditional cylinder cushions are difficult to adjust with accuracy
- > When the exposed cushion adjustment needle is not desired
- > To reduce the effects of pneumatic bounce

Ultra Cushion®

A Major Design and Performance Breakthrough in Air Cylinder Cushioning Systems!

Norgren's advanced cushion design features a unique, one-piece, nitrile compound seal that is captured within a precision machined groove. This allows both linear and radial "float" of the cushion seal which virtually eliminates problems associated with misalignment. Integral flow paths molded in the periphery of the seal provide exceptionally fast "out of cushion" stroke reversal without the use of ball checks.

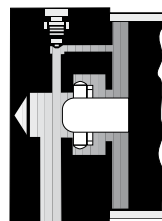

Figure 1

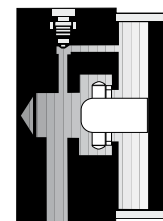
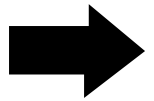

Figure 2 shows spear exiting cushion seal.



Summary of Sound Levels in Decibels

PSI Air Sound Pressure Level +		Cylinder Model Number			
		A0133B3 5" X 6"	Ecology EA0155B3 5" X 6"	A1133A3 2" X 6"	Ecology EA1155A3 2" X 6"
95 PSI+	End ++	108	73	110	74
	Side ++	112	84	110	81
50 PSI+	End ++	108	73	113	74
	Side ++	113	85	110	81

Complete technical data for the Ecology option can be found in the corresponding product line section of the catalog

Ecology Seal Availability

The Patented Ecology Seal Technology has been made available across Norgren's most popular cylinder ranges. Incorporate the Ecology Seal into any of the ranges outlined below for impact dampening and noise reduction.



A Series Aluminum NFPA Cylinder (EA Series with Ecology seals)

Designation: **EA Prefix**

Bore Sizes: 1-1/2", 2", 2-1/2", 3-1/4", 4", 5", 6", 7", 8", 10", 12"

Available with high temp seals (FPM)

Fixed Cushions or Adjustable Cushions



J Series Steel NFPA Cylinder (EJ Series with Ecology Seals)

Designation: **EJ Prefix**

Bore Sizes: 1-1/2", 2", 2-1/2", 3-1/4", 4", 5", 6", 7", 8", 10", 12"

Available with high temp seals (FPM)

Fixed Cushions or Adjustable Cushions



LS Series NFPA Linear Slides

Designation: **"EA" or "EJ" in position 3 of model number**

Bore Sizes: 1-1/2", 2"

Available with high temp seals (FPM)

Fixed Cushions or Adjustable Cushions



SS Series Stainless Steel NFPA

Designation: **"6" in 11th position of model number**

Bore Sizes: 1-1/8", 1-1/2", 2", 3-1/4", 4", 5", 6", 8"

Available with high temp seals (FPM)

Fixed Cushions or Adjustable Cushions

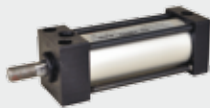

TAE Series NFPA Tiny Tim

Bore Sizes: 3/4", 1", 1-1/8"

ET Series Non-NFPA Tiny Tim

Bore Sizes: 3/4", 1-1/8"

Designation: **ET or TAE Prefix**

Available with high temp seals (FPM)

Adjustable Cushions



DA/8000 and PDA/182000 Series ISO/VDMA Cylinder

Designation: **BDA or BPDA Prefix**

Bore Sizes: 40mm, 50mm, 63mm, 80mm

Available with high temp seals (FPM)

Adjustable Cushions



RP Series Roundline Plus Disposable Cylinder

Designation: **ERP Prefix**

Bore Sizes: 3/4", 1-1/16", 1-1/4", 1-1/2", 2", 2-1/2" 3"

Available with high temp seals (FPM)

Fixed Cushions



RPD Series Acetal Resin Roundline Plus Disposable Cylinder

Designation: **ERPD Prefix**

Bore Sizes: 3/4", 1-1/16", 1-1/2", 2"

Available with high temp seals (FPM)

Fixed Cushions



RT Series Roundline Plus Thrusters

Designation: **ERT Prefix**

Bore Sizes: 3/4", 1-1/16", 1-1/2", 2", 2-1/2", 3"

Available with high temp seals (FPM)

Fixed Cushions

Impact dampening seals
Adjustable captive cushion needle
Ecology cylinders meet OSHA noise standards
Constructed of the finest materials

Technical features
Medium:

Filtered compressed air to 250 PSI
 Petroleum based hydraulic fluid to
 400 PSI (with non-cushioned A &
 J Series only)

Operating temperature:

Series A & J -20°F to 200°F
 with FPM Seals -20°F to 400°F

Operating Pressure:

A & J Series: 250 PSIG Air,
 400 PSIG Hydraulic non-shock
 EA & EJ Series: 250 PSIG Air

Available Bore Sizes:

1-1/2", 2", 2-1/2",
 3-1/4", 4", 5", 6", 7", 8", 10", 12"

Lubrication:

None required
 Norgren Air Cylinders are rated
 for "no lube added" service. All
 internal components are lubricated
 at time of assembly with a PTFE
 based grease.

Materials
Head and End Caps:

(A and EA Series)
 black anodised aluminum alloy
 (J and EJ Series)
 precision machined steel

Tube:

A & EA Series 1-1/2" to 10"
 J & EJ Series 1-1/2" to 2-1/2"
 Aluminum alloy, clear anodised
 O.D., hard coat anodised I.D.
 J & EJ Series 3-1/4" to 12" has
 steel tube, with hard chrome
 plated I.D.

Piston:

A & EA series: machined high-
 strength aluminum alloy.

J & EJ series: steel

Piston rod: hard chrome plated
 steel

Rod Bearing: oil impregnated
 sintered iron

Seals: Nitrile rod seal/wiper, nitrile
 piston and tube end seals

Tie Rods: high-tensile strength
 steel

1 Ultra Cushion® Seals: Advanced design features a unique, one-piece, compound seal of nitrile* captured within a precision machined groove. Linear and radial "float" of the cushion seals eliminates misalignment. Ultra Cushions provide exceptionally fast "out of cushion" stroke reversal. (Head and Cap Cushions are optional.)

* Nitrile seals on the 5/8" & 1" rod diameter.
 For rod sizes 1-3/4" and larger, urethane seals are standard.

2 O-Ring Tube Seal: Nitrile is standard. (FPM is optional.)

3 Adjustable Captive Cushion Needle: A one-piece, precision threaded stainless steel cushion adjustment screw with a threaded stainless steel capture ring. It provides safe and precise cushion adjustment.

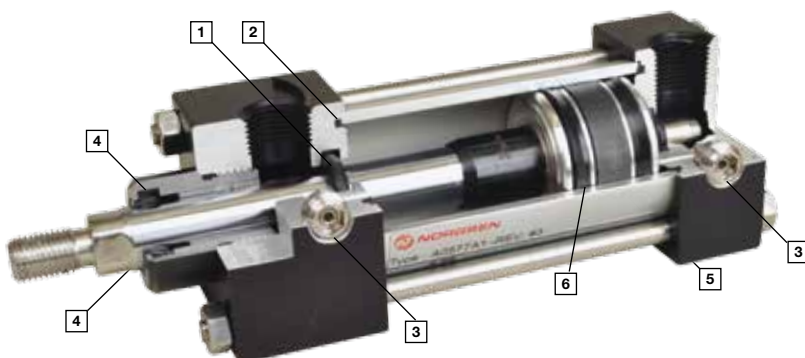
A & J Series

EA & EJ Series
Impact dampening Ecology Seals

4 Rod Seal/Wiper: Combination rod seal & wiper in one. One end is a lip-type seal that is pressure energized and wear compensating. The opposite side is a lip-type wiper designed to keep contaminants from getting into the cylinder by aggressively wiping foreign materials from the piston rod, enhancing the rod seal life. Made from a long-wearing nitrile material and is suitable for "no lube added" operation.

5 Wear Ring: Reinforced PTFE compounded with polyphenylene sulfide provides supreme wear and excellent bearing support.

6 Piston Seals

A & J: Long wearing nitrile seals

EA & EJ: Impact dampening Ecology seals, in conjunction with our advanced cushion design, decelerate and reduce end-of-stroke noise.

Norgren NFPA Ecology Cylinders offer these advantages:

1 Norgren cylinders are pre-lubricated for non-lube operation. The piston rod is self-lubricated by the oil-impregnated rod bearing during operation. Lubrication between piston and cylinder barrel is derived from the polishing qualities of the reinforced PTFE wear ring.

The low friction surfaces extend the life of the seals beyond normal expectations.

Series EA and EJ cylinders are NFPA interchangeable and are available in many different mounting styles.

2 Operates Quietly to Meet OSHA Specifications. Series EA and EJ cylinders provide substantial reductions in impact noise, which reduces overall machine noise and helps meet government regulations.

The summary of sound decibels chart illustrates the operating sound levels.

The impact dampening qualities of the Piston Seals are guaranteed for ONE FULL YEAR!

Summary of Sound Levels in Decibels

PSI Air Sound Pressure Level+	Cylinder Model	Cylinder Model							
		J133B3 5" x 6"	EJ155B3 5" x 6"	J1133A3 2" x 6"	EJ1155A3 2" x 6"	A133B3 5" x 6"	EA155B3 5" x 6"	A1133A3 2" x 6"	EA1155A3 2" x 6"
95 End++		108	73	110	74	108	73	110	74
PSI+ Side++		112	84	110	81	112	84	110	81
50 End++		108	73	113	74	108	73	113	74
PSI+ Side++		113	85	110	81	113	85	110	81

+Peak sound pressure is given in decibels (dB) re:2 x 10⁻⁵ N/m². ++End position of mike was 3' on centerline from end of cylinder; side position of mike was 3' perpendicular to centerline abeam of end of cylinder.
Note: At 5 feet, cylinder sound levels would be less by 9 dB from side figure and 13 dB from end figure. The total noise emitted will depend on the structure to which the cylinder is attached. If it is mounted on a thin flat plate of considerable area, the noise will be increased by a sounding board effect.

3 Energy Absorption Capacity of the Impact Dampening Seals.

Series EA and EJ cylinders have a impact dampening piston seal that accomplishes 80% of the actual load stopping. The air cushion accounts for only 20%. (A conventional air cushioning cylinder depends 100% on the compressibility of air to do the stopping.) The Ecology seal absorbs high impact loads allowing the effect of the air cushion to be reduced by using a larger air cushion bleed orifice. As a result the piston can move at a faster speed for a longer period of time before the Ecology seal does the final stopping.

Energy Absorption Capacity of the Impact Dampening Seals

*Usable Pounds Stoppable at the Following Piston Speeds

This chart features the energy absorption capacity of the impact dampening piston seals with a **Non-Adjustable** cushions. For higher loads and velocities please refer to the Decel- Air Cushion.

In/Sec	Cylinder Bore										
	1 1/2	2	2 1/2	3 1/4	4	5	6	7	8	10	12
6	155.6	275.5	499.8	969.3	1505.4	2603.2	4159.8	5794.2	8067.6	12,242	20,139
12	38.4	68.1	123.4	239.7	372.6	644.8	1030.2	1435.8	2000.4	3026	4971
18	16.7	29.7	53.7	104.6	162.8	282.1	450.6	628.7	876.8	1319.3	2162.1
24	9.2	16.3	29.4	57.3	89.4	155.2	247.8	346.2	483.6	722	1179
30	5.6	10.0	18.1	35.4	55.4	96.4	153.9	215.4	301.6	445.5	724
36	3.7	6.7	11.9	23.5	37.0	64.5	102.9	144.4	202.7	295.3	476.8
42	2.6	4.6	8.2	16.3	25.8	45.3	72.2	101.6	143.1	204.8	327.7
48	1.8	3.2	5.8	11.7	18.6	32.8	52.2	73.8	104.4	146	231
54	1.3	2.4	4.2	8.5	13.6	24.2	38.5	54.7	77.9	105.7	164.7
60	1.0	1.8	3.0	6.2	10.1	18.1	28.7	41.1	58.9	76.9	117.2

*The weight of the cylinder piston has been deducted from the figures shown above.
Note: The use of FPM Seals limits the absorption of the impact dampening seals by 50%.

Energy absorption capacity of impact dampening piston seals w/ adjustable cushion.

In/Sec	Cylinder Bore										
	1 1/2	2	2 1/2	3 1/4	4	5	6	7	8	10	12
6	279	495	899	1,744	2,709	4,685	7,486	10,429	4,520	22,035	36,250
12	68	122	221	430	699	1,159	1,854	2,583	3,800	5,446	8,947
18	30	53	95	187	291	507	810	1,130	1,576	2,374	3,891
24	16	29	52	102	160	279	444	622	869	1,299	1,414
30	10	18	32	63	99	172	275	387	541	801	1,303
36	6.7	12	21.6	42	66	116	183	259	363	531	856
42	4.7	8.3	14.7	29	46	81	129	181	257	367	588
48	3.4	5.7	10.4	21	33	59	93	131	187	262	415
54	2.3	4.3	7.6	15.3	24	43	68	97	138	189	295
60	1.8	3.2	5.4	11	18	33	52	74	106	138	211

Effect of Impact Dampening Seals on Total Stroke of Cylinders

PSI	Cylinder Bore										
	1 1/2	2	2 1/2	3 1/4	4	5	6	7	8	10	12
0	.14	.15	.17	.19	.22	.25	.28	.32	.32	.36	.40
20	.10	.10	.12	.14	.16	.18	.20	.22	.22	.24	.26
40	.07	.07	.08	.09	.10	.12	.13	.14	.14	.15	.16
60	.04	.04	.05	.05	.06	.07	.07	.08	.08	.09	.10
80	.02	.02	.02	.02	.03	.03	.03	.04	.04	.04	.04
100	0	0	0	0	0	0	0	0	0	0	0

Note: These figures are for new cylinders. The impact dampening seals will take some compression set during operation of the cylinder and the stroke loss will decrease. Also, the pressure at zero stroke loss will decrease to about 80 psi. At pressures above those of zero stroke loss, a slight clicking sound may be produced during impact. To determine the stroke loss for either the head or cap end, divide the value shown by 2.

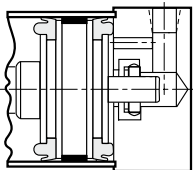

Piston and rod assembly for 1-1/2" thru 5" bore cylinders with 1/2" to 2" stroke



Solenoid valve technology

IMI Precision Engineering offers a number of safe, reliable and cost-effective integrated solenoid valve solutions for actuation control in upstream and downstream applications including the control of process pneumatic actuators and the control and handling of neutral and aggressive gases and liquids. Our valves are typically manufactured with stainless steel housings and Ex-proof coils, with a broad choice of materials for seals to suit the environmental and application specifications.

Our high integrity valves have:

- > A field proven track record
- > 10 year service interval (6 years to maintain SIL 3)
- > Wide range of flow and function options
- > Stainless Steel, Aluminum or Brass construction options
- > Industry leading Force Friction Ratio (FFR)
- > Cable terminations inside coil - No additional Ex terminations required
- > Rated for 100% duty
- > Wide temperature range -76°F to 248°F (-60°C to 120°C)
- > International approvals
- > SIL approved

The critical safety element of a solenoid valve is its Force Friction Ratio (FFR). The FFR is a measure of the relationship between the force presented by the spring return mechanism and the frictional resistance within the valve. In basic terms, the higher the FFR, the more likely the valve is to operate when demanded, as the spring will have a force in excess of the friction.

Poppet design solenoid valves generate much lower friction than spool design solenoid valves, and this advantage is greatly enhanced at extreme temperatures – both hot and cold.

IMI Maxseal and IMI Herion solenoid valves offer an FFR of 10 - the highest in the industry.

Force friction ratio



Tests by the Milwaukee School of Engineering confirm

Ecology Cylinder Cushions are more efficient, faster acting and bounce less!

ECOLOGY CYLINDERS with Non-Adjustable Cushions

2" Bore Rod End Cushion Test

Average deceleration force = 15 G's
Time consumed during cushioning = 0.030 sec.
Number of bounces: 1 Pneumatic – 1 Metallic

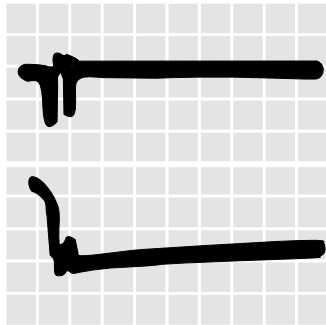

Acceleration: 1 div. = 10 G's
X Axis: 1 div. = .03 seconds

Velocity: 1 div. = 20 in/sec.
14.5 lbs. added to rod

NORGREN ECOLOGY CYLINDERS with Adjustable Cushions

2" Bore Rod End Cushion Test

Average deceleration force = 20 G's
Time consumed during cushioning = 0.015 sec.
Number of bounces: 1/2 Pneumatic – 0 Metallic

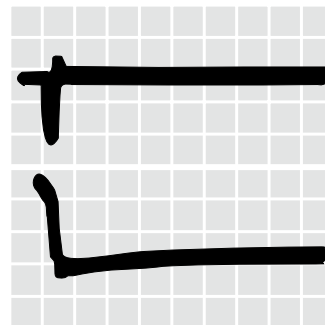

Acceleration: 1 div. = 10 G's
X Axis: 1 div. = .03 seconds

Velocity: 1 div. = 20 in/sec.
2.5 lbs. added to rod

COMPETITIVE CYLINDERS with Adjustable Cushions

2" Bore Rod End Cushion Test

Average deceleration force = 78 G's
Time consumed during cushioning = 0.120 sec.
Number of bounces: 2 Pneumatic – 4 Metallic

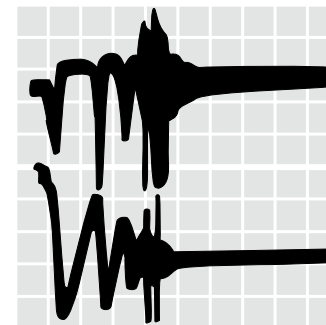

Acceleration: 1 div. = 10 G's
X Axis: 1 div. = .03 seconds

Velocity: 1 div. = 20 in/sec.
14.5 lbs. added to rod

2" Bore Cap End Cushion Test

Average deceleration force = 17.5 G's
Time consumed during cushioning = 0.025 sec.
Number of bounces: 1 Pneumatic – 1 Metallic

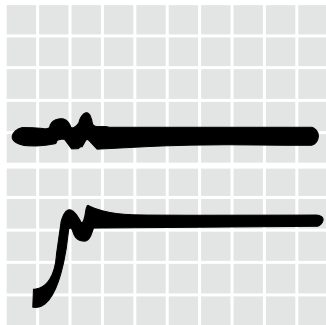

Acceleration: 1 div. = 10 G's
X Axis: 1 div. = .03 seconds

Velocity: 1 div. = 20 in/sec.
14.5 lbs. added to rod

2" Bore Cap End Cushion Test

Average deceleration force = 10 G's
Time consumed during cushioning = 0.020 sec.
Number of bounces: 1/2 Pneumatic – 0 Metallic

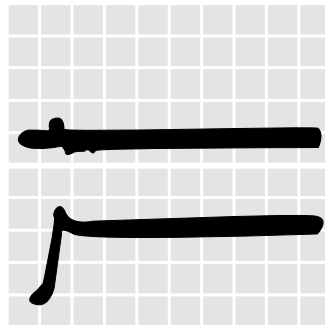

Acceleration: 1 div. = 10 G's
X Axis: 1 div. = .03 seconds

Velocity: 1 div. = 20 in/sec.
2.5 lbs. added to rod

2" Bore Cap End Cushion Test

Average deceleration force = 60 G's
Time consumed during cushioning = 0.120 sec.
Number of bounces: 3 Pneumatic – 4 Metallic

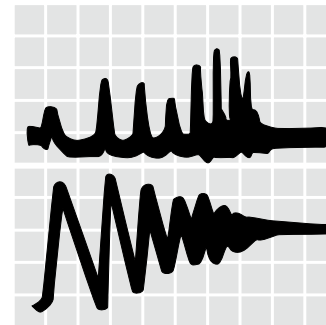

Acceleration: 1 div. = 10 G's
X Axis: 1 div. = .02 seconds

Velocity: 1 div. = 20 in/sec.
14.5 lbs. added to rod

2" Bore Cylinder Tests Results

Figures shown are average and not the result of each individual test. Piston velocity was regulated at 45 in/sec.

Cylinders with Cushions	Weight attached to Piston Rod (lbs)	Cushion Efficiency (G's* Created)	Cushioning Time (Ms)	Bounce Cycles During Cushioning
Norgren Ecology Adjustable	8.5	14.50	25.00	1.00
Norgren Ecology Non-Adjustable	8.5	17.50	26.25	1.75
Competitor A Adjustable	8.5	48.00	107.50	7.25
Competitor B Adjustable	8.5	32.75	102.50	6.50
Competitor C Adjustable	8.5	50.50	81.25	9.25

*Measured in G's of deceleration force created. All cylinders tested were NFPA types, front flange mounting, 6" stroke with standard diameter piston rods.

4" Bore Cylinder Tests Results

Figures shown are average and not the result of each individual test. Piston velocity was regulated at 25 in/sec.

Cylinders with Cushions	Weight attached to Piston Rod (lbs)	Cushion Efficiency (G's* Created)	Cushioning Time (Ms)	Bounce Cycles During Cushioning
Norgren Ecology Adjustable	54	5.25	40.00	3.25
Norgren Ecology Non-Adjustable	54	12.00	28.75	2.75
Competitor A Adjustable	54	11.50	92.50	6.75
Competitor B Adjustable	54	8.00	77.50	5.25
Competitor C Adjustable	54	6.50	67.50	6.25

*Measured in G's of deceleration force created. All cylinders tested were NFPA types, front flange mounting, 6" stroke with standard diameter piston rods.

Decel-Air Cushioned Cylinder

Eliminates the need for shock absorbers on air cylinder applications.

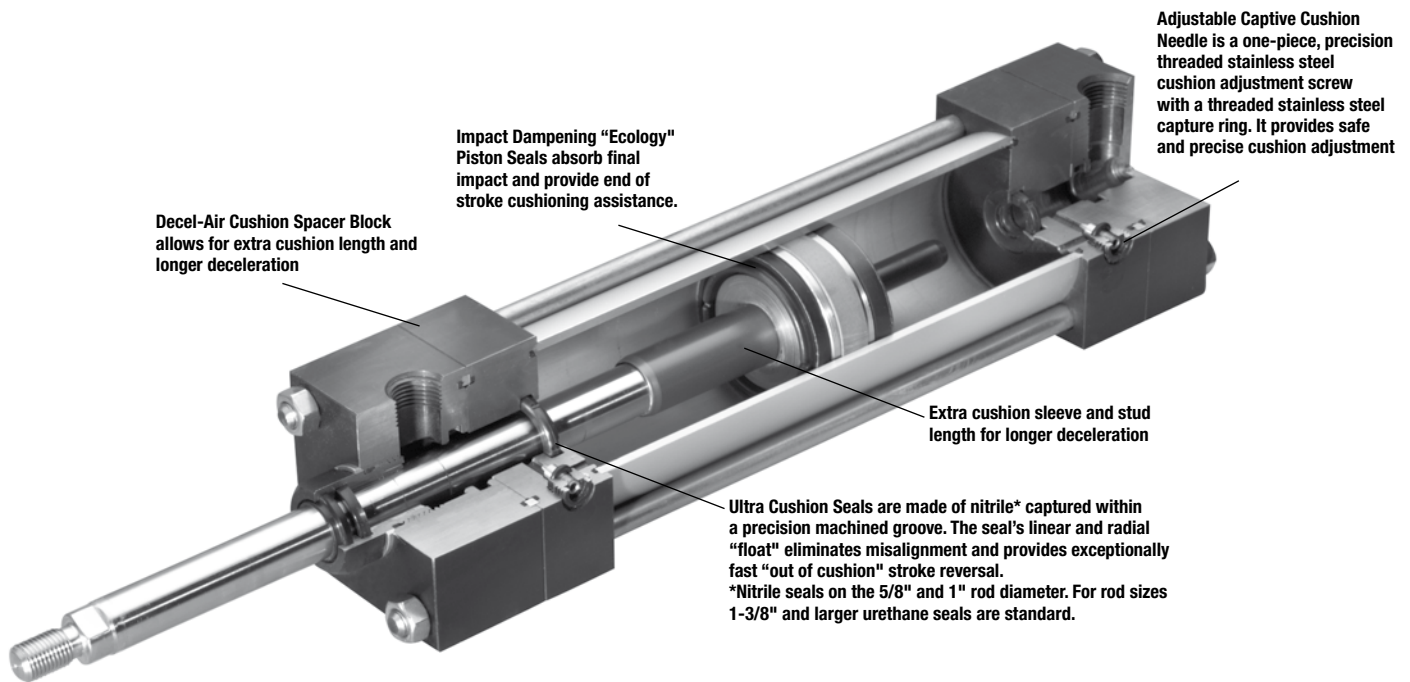

Explanation of Decel-Air Cushion:

Norgren's Decel Cushioned cylinder was designed for applications where high velocity, low mass, material transfer or machine function is required, and where the kinetic energy to be absorbed during cushioning exceeds the parameters of our standard Series EA or EJ air cylinders equipped with non-adjustable or adjustable cushions. Decel cushions employ longer-than-standard air cushions to assist our Impact Dampening Piston Seal.

Why does our Decel-Air Cushion work?

The extra cushion length of the Decel cushioned cylinder provides an additional deceleration capability to slow the cylinder's moving mass to a point where the positive cushioning effect of our Impact Dampening Piston Seals can perform the final cushioning.

Norgren's Decel-Air Cushioned Cylinders Versus Cylinder Mounted Shock Absorbers

The first extensive evaluation of pneumatic cylinder cushion performance was undertaken by the Mechanical Engineering Department of The Ohio State University. The test was conducted on 2-1/2" bore, 12" stroke. The OSU tests found the Decel Cushioned cylinders absorbed almost three times as much kinetic energy with a lower level of peak cushion as a standard Ecology seal configured cylinder.

Because air is compressible and is exhausted out of the cylinder each cycle, the internal heat buildup is minimized. The **"Maximum Inch Pounds Per Hour"** rating which is essential in determining the effectiveness of shock absorber performance is **not needed** to judge Decel cushion performance.

The test indicated that Norgren Decel-Air Cushioned cylinders could prove to be superior to a hydraulic shock absorber assisted cylinder for high cycle, high velocity applications with light to moderate loading (precisely the area where most severe cylinder applications exist). The cycle rates and the cushioning times of the Decel-Air Cushioned cylinders and the hydraulic shock absorber assisted cylinders were comparable.*

Decel-Air Cushioned cylinders are also less costly than shock absorber mounted cylinders and are self-contained units.

*For comparative evaluation, a well-known hydraulic shock absorber was chosen. The OSU tests showed a smooth shock-absorbing operation was achieved at very low velocities using the shock absorbers, but at comparable Decel Cushion cylinder velocities, a high mechanical impact took place on the shock absorber mounted cylinder.

Potential Decel-Air Cushion Applications

1. Conveyors & Material Handling Equipment
2. Transfer Machines & Shuttle Tables
3. Packaging Machinery
4. Foundry Equipment
5. Automatic Gate Opening & Closing

The Decel Cushioned cylinder increases the kinetic energy absorption capability by increasing the effective cushion spear length in the cylinder.

The Decel Cushioned cylinder increases the standard cushion spear length by 100%, allowing an increase in kinetic energy absorption capability by two times.

Decel Cushioned Cylinder Fully Cushioned Load Stopping Capacity in Pounds*

In/Sec	Cylinder Bore											
	1-1/2	2	2-1/2	3-1/4	4	5	6	7	8	10	12	
6	558	990	1798	3488	5418	9370	14972	20040	20858	44070	72500	
12	136	244	442	860	1338	2318	3708	5166	7600	10892	17894	
18	60	106	190	374	582	1014	1620	2260	3152	4748	7782	
24	32	58	104	204	320	558	888	1244	1738	2598	2828	
30	20	36	64	126	198	344	550	774	1082	1602	2606	
36	13.4	24	43	84	132	232	366	518	726	1062	1712	
42	9.4	16.6	29	58	92	162	258	362	514	734	1176	
48	6.8	11.4	20.8	42	66	118	186	262	374	524	830	
54	4.6	8.6	10.8	30	48	86	136	194	276	378	590	

Piston Rod Dia. Weights*

5/8"	- .30 lb. + 0.09 lb./in. stroke
1"	- .90 lb. + 0.22 lb./in. stroke
1-3/8"	- 2.2 lb. + 0.42 lb./in. stroke
1-3/4"	- 4.0 lb. + 0.68 lb./in. stroke
2"	- 5.5 lb. + 0.90 lb./in. stroke
2-1/2"	- 10.1 lb. + 1.40 lb./in. stroke

Double Weight for double rod end cylinders

*Include piston rod weight in total load to be stopped

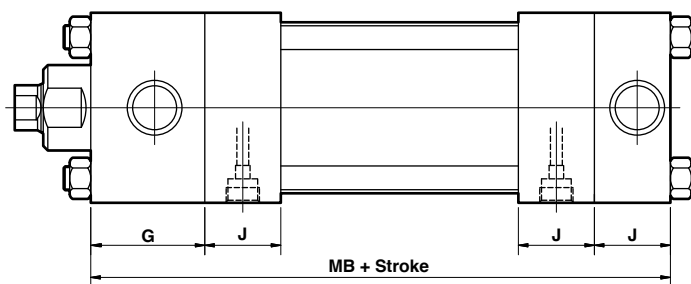

- NOTE:
- All dimensions not shown are per STD NFPA dimensions
 - For cylinders with (1) Decel Cushion AOL dimension will be "MB"- "J".

Decel Cushioned cylinder envelope dimensions are not NFPA dimensionally interchangeable over the stroke length.

Basic Envelope Dimensions

Cyl. Bore	G	J	Add Stroke MB
1-1/2	1-1/2	1	5-5/8
2	1-1/2	1	5-5/8
2-1/2	1-1/2	1	5-3/4
3-1/4	1-3/4	1-1/4	6-3/4
4	1-3/4	1-1/4	6-3/4
5	1-3/4	1-1/4	7
6	2	1-1/2	8
7	2	1-1/2	8-1/8
8	2	1-1/2	8-1/8

Cylinder Order Information

EJ 01 7 7 A 1-2.00 x 6.000 - L(14)-PS-V

Series	
Series A Cylinder (Aluminum)	A
Series A Double Rod End Cylinder	DA
Series EA Cylinder	EA
Series EA Double Rod End Cylinder	EDA
Series J Cylinder (Steel)	J
Series J Double Rod End Cylinder	DJ
Series EJ Cylinder	EJ
Series EJ Double Rod End Cylinder	EDJ

Mounting Options	
Side Tapped (MS4)	01
Head Rectangular Flange (MF1)	03
Head Square (ME3) – 7" & 8" Bores	03
Cap Rectangular Flange (MF2)	04
Cap Square (ME4) – 7" & 8" Bores	04
Basic Cylinder No Mounting (MX0)	05
Both Ends (4) Tie Rods Ext. (MX1)	06
Both Ends (2) Tie Rods Ext. (MX4)	6B
Cap Tie Rods Ext. (MX2)	6C
Head Tie Rods Ext. (MX3)	6R
Removable Head Trunnion (MT1) - A & EA	7R
Head Trunnion (MT1) - J & EJ	07
Removable Cap Trunnion (MT2) - A & EA	8R
Cap Trunnion (MT2) - J & EJ	08
Side Lugs (MS2)	09
Center Trunnion (MT4)	10
Side End Angles (MS1)	11
Cap Fixed Clevis (MP1)	12
Side End Lugs (MS7)	15
Sleeve Nut Construction (Universal)	16
Head Square Flange (MF5)	20
Cap Square Flange (MF6)	21
Detachable Cap Clevis (MP2)	22
Cap Fixed Eye (MP3)	32
Detachable Cap Eye (MP4)	42
Spherical Bearing	52
Base Bar (Not NFPA A & EA Only)	60

Cushion in Head	
None	3
Non-Adjustable Cushion	†5
Adjustable Cushion (Position 2)	7
Decel Cushion	9

† Standard with EA & EJ

Cushion in Cap	
None	3
Non-Adjustable Cushion	†5
Adjustable Cushion (Position 2)	7
Decel Cushion	9

† Standard with EA & EJ

Additional Standard Options - See next page for full listing	
Case Hardened (50 Rc)	HR
Port Location position 1 standard: L(Head Cap) (specify position 1 thru 4 for head and/or cap)	L(_)
Rod Lock (passive)	LE
Low Friction	LF
Stroke Adjustment	A
Metal Rod Scraper	MS
Cushion Adjust Screw Location position 2 standard: N(Head Cap) (specify position 1 thru 4 for head and/or cap)	N(_)
Non-Standard Port Sizes: [specify port size for P(_H) head only, P(_C) cap only, or P(_L) both head & cap]	*P(_)
Magnetic Piston – includes aluminum tube option - J & EJ	PS
Rod Stud	RS
Rod Extensions (specify length of additional rod extension)	RX
Stainless Steel tie-rods	S
303 Stainless Steel (Hard Chrome Plated)	SS
Stainless Steel bushing	SB
Stop Tube (specify stop tube length)	ST(_)
Special Rod Threads (specify rod thread)	T
Thread Extensions (specify length of thread extension)	TX
FPM Seals	V

* Oversized ports may increase the overall length by 1/8". Consult factory for impacted models.

Piston Rod Threads	Type	Dim ref
Small Male (Solid) (std)	1	KK
Intermediate Thread Male (Solid)	2	CC
Female	3	KK
Full Thread Male (Solid)	6	FF
Plain Rod End	7	-

Cyl bore	rod ltr.	rod dia. (mm)	Cyl bore	rod ltr.	rod dia. (mm)
1-1/2	A	5/8	6	C	1-3/8
	B+	1		D	1-3/4
2	A	5/8		E	2
	B	1	7	F	2-1/2
	C+	1-3/8		C	1-3/8
2-1/2	A	5/8		D	1-3/4
	B	1		E	2
	C	1-3/8		F	2-1/2
	D+	1-3/4	8	C	1-3/8
3-1/4	B	1		D	1-3/4
	C	1-3/8		E	2
	D	1-3/4		F	2-1/2
	E	2	10	D	1-3/4
4	B	1		E	2
	C	1-3/8		F	2-1/2
	D	1-3/4	12	E	2
	E	2		F	2-1/2
	F	2-1/2			
5	B	1			
	C	1-3/8			
	D	1-3/4			
	E	2			
	F	2-1/2			

Notes
 + Head cushion not available on these bore and piston rod combinations.
 Additional rod sizes available upon request.
 Dimensions for thread sizes available on following pages.

Port and Cushion Adjustment Positions

(As viewed from rod end: Port standard position 1, Cushion Adjustment standard position 2.)

NOTE: A Port and a Cushion Adjustment cannot be in the same position.

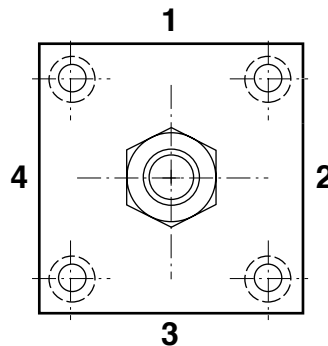

A, EA, J, and EJ Standard and special cylinder options

Option Code, (list alphabetically)	Description
A(-)	Stroke adjustment single piston (specify adjustment length)
AA(-)	Stroke adjustment double piston (specify adjustment length)
BL	Removable piston rod stud (installed with removable adhesive sealant)
HR	Case hardened piston rod
L(- -)	Non-standard port location position 1 standard: L (Head Cap) (specify position 1 thru 4 for head and/or cap)
LA	Low friction cylinder (Pak-Lap™ style seals)
LE	Rodlock
LF	Low friction cylinder (Nitrile compounded with PTFE rod and piston seals) (Not available with Ecology series)
MS	Metal scraper
N(- -)	Cushion adjust screw location position 2 standard:N(Head Cap) (specify position 1 thru 4 for head and/or cap)
P(-)*	Non-standard port sizes – [specify port size for P(-H) head only, P(-C) cap only, or P(-) both head & cap]
PP	Seals in cylinder O-ring loaded U-cups (rod and piston seals) – (A & J Only)
PN	Pinned piston and rod assembly
PS	Magnetic piston modification
RS	Studded male piston rod end
RX(-)	Piston rod extension over standard (specify additional "C" length)
S	303/304 Stainless steel tie rods & nuts
SB	Stainless steel rod bushing nut
SC†	Single acting spring extend cap end of cylinder
SL	Steel cylinder tubing
SR†	Single acting spring retract rod end of cylinder
SS	303 Stainless steel piston rod
ST(-)	Stop tube on rod end of cylinder: ST
SV(- -)	Stroke signal valve(s): SV (head cap)
T(-)	Non-standard piston rod thread (specify thread)
TF(-)	Piston rod thread depth over standard (Female) (specify additional "A" length)
TS	Stainless steel cylinder tubing
TX(-)	Piston rod thread extension over standard (Male) (specify additional "A" length)
UB	Head and cap bumpers (Adds 1/4" per bumper to overall length)
V	FPM seals in cylinder
XI(-)	Type #10 trunnion set dimension (MT4 model only) (customer must specify length)

†Standard available for 1 1/2", 2", 2-1/2" bores, 12" max stroke. 12 lbs. force preload, 30 lbs. force compressed.

Cushions not available on spring end. For other spring forces, bore sizes or longer strokes, consult factory.

*Oversized ports may increase the overall length by 1/8", consult factory for impacted models.

Consult Factory for These Special Options:

Option Code	Description
AP	Air/Oil piston (piston supplied with O-ring hooded U-cup on cap end for air/oil operation)
BB	Cylinders mounted back to back
EN*	Electroless nickel plated cylinder
H	Piston rod seals O-ring loaded U-cups – (A & J Only)
RB	Rod boot over piston rod
UA	Unit-Air assembly (valve mounted to cylinder)
UC	Cap bumper (Adds 1/4" per bumper to overall length)
UH	Head bumper (Adds 1/4" per bumper to overall length)
TK	Thrust key plate mounting – [01 (MS4), 09 (MS2), and 15 (MS7)]
VM	Valve mounting only

* When ordering "EN" option specify S, SS, TS options.

NFPA (MX0) 05 Basic Mount

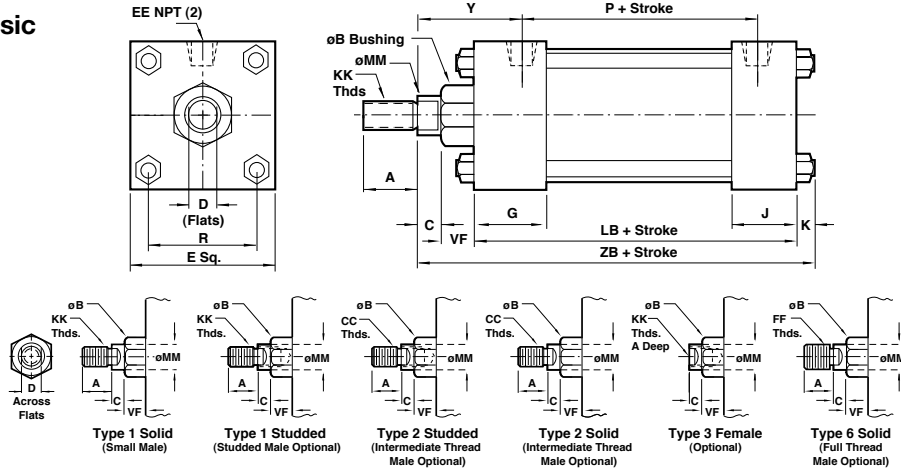

Bore		1-1/2"	2"	2-1/2"	3-1/4"	4"	5"	6"	7"	8"	10"	12"
ø Rod	Std.	5/8"	5/8"	5/8"	1"	1"	1"	1-3/8"	1-3/8"	1-3/8"	1-3/4"	2"
	O.S.	1"	1"	1"	1-3/8"	1-3/8"	1-3/8"	1-3/4"	1-3/4"	1-3/4"	2"	2-1/2"
A	Std.	.750	.750	.750	1.125	1.125	1.125	1.625	1.625	1.625	2.000	2.250
	O.S.	1.125	1.125	1.125	1.625	1.625	1.625	2.000	2.000	2.000	2.250	3.000
B +.000 -.002	Std.	1.124	1.124	1.124	1.499	1.499	1.499	1.999	1.999	1.999	2.374	2.624
	O.S.	1.499	1.499	1.499	1.999	1.999	1.999	2.374	2.374	2.374	2.624	3.124
C	Std.	.375	.375	.375	.500	.500	.500	.625	.625	.625	.750	.875
	O.S.	.500	.500	.500	.625	.625	.625	.750	.750	.750	.875	1.000
CC	Std.	1/2 - 20	1/2 - 20	1/2 - 20	7/8 - 14	7/8 - 14	7/8 - 14	1-1/4-12	1-1/4-12	1-1/4-12	1-1/2-12	1-3/4-12
	O.S.	7/8 - 14	7/8 - 14	7/8 - 14	1-1/4-12	1-1/4-12	1-1/4-12	1-1/2-12	1-1/2-12	1-1/2-12	1-3/4-12	1-3/4-12
D	Std.	.500	.500	.500	.813	.813	.813	1.125	1.125	1.125	1.500	1.688
	O.S.	.813	.813	.813	1.125	1.125	1.125	1.500	1.500	1.500	1.688	2.063
E	Std.	2.000	2.500	3.000	3.750	4.500	5.500	6.500	7.500	8.500	10.625	12.750
	O.S.	.375	.375	.375	.500	.500	.500	.750	.750	.750	1.000	1.000
FF	Std.	5/8-18	5/8-18	5/8-18	1 - 14	1 - 14	1 - 14	1-3/8-12	1-3/8-12	1-3/8-12	1-3/4-12	2-12
	O.S.	1 - 14	1 - 14	1 - 14	1-3/8-12	1-3/8-12	1-3/8-12	1-3/4-12	1-3/4-12	1-3/4-12	2-12	2-1/2-12
G	Std.	1.500	1.500	1.500	1.750	1.750	1.750	2.000	2.000	2.000	2.250	2.250
	O.S.	1.000	1.000	1.000	1.250	1.250	1.250	1.500	1.500	1.500	2.000	2.000
K	Std.	.250	.313	.313	.375	.375	.438	.438	.563	.563	.688	.688
	O.S.	7/16 - 20	7/16 - 20	7/16 - 0	3/4 - 16	3/4 - 16	3/4 - 16	1 - 14	1 - 14	1 - 14	1-1/4 - 12	1-1/2 - 12
LB	Std.	3.625	3.625	3.750	4.250	4.250	4.500	5.000	5.125	5.125	6.375	6.875
	O.S.	2.340	2.340	2.470	2.690	2.690	2.940	3.125	3.250	3.250	4.125	4.625
R	Std.	1.428	1.838	2.192	2.758	3.323	4.101	4.87	5.730	6.442	8.004	9.4069
	O.S.	.625	.625	.625	.875	.875	.875	1.000	1.000	1.000	1.125	1.125
Y	Std.	1.840	1.840	1.840	2.380	2.380	2.380	2.813	2.813	2.813	3.125	3.250
	O.S.	2.220	2.220	2.220	2.630	2.630	2.630	3.063	3.063	3.063	3.250	3.500
ZB	Std.	4.875	4.938	5.063	6.000	6.000	6.313	7.063	7.313	7.313	8.938	9.563
	O.S.	5.250	5.313	5.438	6.250	6.250	6.563	7.313	7.563	7.563	9.063	9.813

NFPA (MS4) 01 Side Tapped Mount

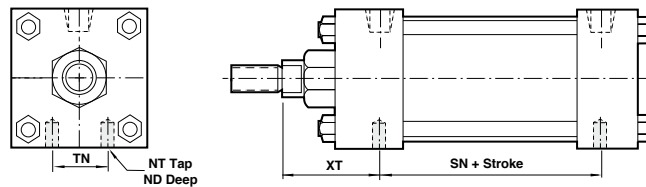

Bore		1-1/2"	2"	2-1/2"	3-1/4"	4"	5"	6"	7"	8"	10"	12"
ND		.375	.375	.500	.750	.750	.938	1.125	1.125	1.125	1.500	1.500
NT		1/4 - 20	5/16 - 18	3/8 - 16	1/2 - 13	1/2 - 13	5/8 - 11	3/4 - 10	3/4 - 10	3/4 - 10	1 - 8	1 - 8
SN		2.250	2.250	2.375	2.625	2.625	2.875	3.125	3.250	3.250	4.125	4.625
TN		.625	.875	1.250	1.500	2.063	2.688	3.250	3.500	4.500	5.500	7.250
XT	Std.	1.938	1.938	1.938	2.438	2.438	2.438	2.813	2.813	2.813	3.125	3.250
	O.S.	2.313	2.313	2.313	2.688	2.688	2.688	3.063	3.063	3.063	3.250	3.500

All dimensions ± .015 unless otherwise noted.

NFPA (MF1) 03 Head Rectangular Flange Mount

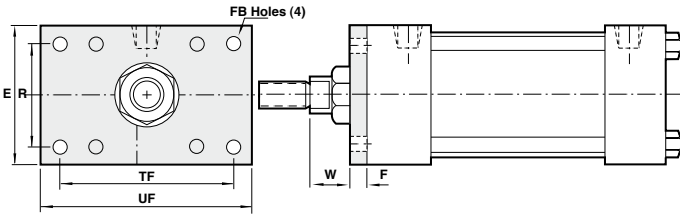

Bore	1-1/2"	2"	2-1/2"	3-1/4"	4"	5"	6"
E	2.000	2.500	3.000	3.750	4.500	5.500	6.500
F	.375	.375	.375	.625	.625	.625	.750
FB	.313	.375	.375	.438	.438	.563	.563
R	1.428	1.838	2.192	2.758	3.323	4.101	4.879
TF	2.750	3.375	3.875	4.688	5.438	6.625	7.625
UF	3.375	4.125	4.625	5.500	6.250	7.625	8.625
W	Std. .625	.625	.625	.750	.750	.750	.875
O.S.	1.000	1.000	1.000	1.000	1.000	1.000	1.125

NFPA (MF2) 04 Cap Rectangular Flange Mount

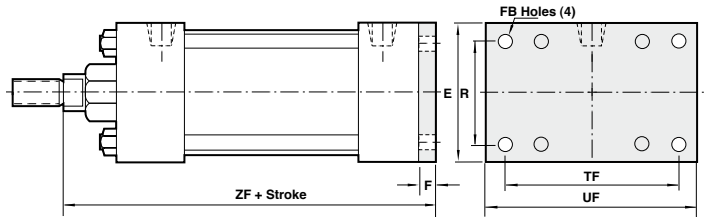

Bore	1-1/2"	2"	2-1/2"	3-1/4"	4"	5"	6"
E	2.000	2.500	3.000	3.750	4.500	5.500	6.500
F	.375	.375	.375	.625	.625	.625	.750
FB	.313	.375	.375	.438	.438	.563	.563
R	1.428	1.838	2.192	2.758	3.323	4.101	4.879
TF	2.750	3.375	3.875	4.687	5.438	6.625	7.625
UF	3.375	4.125	4.625	5.500	6.250	7.625	8.625
ZF	Std. 5.000	5.000	5.125	6.250	6.250	6.500	7.375
O.S.	5.375	5.375	5.500	6.500	6.500	6.750	7.625

NFPA (ME3) 03 Head Square Mount

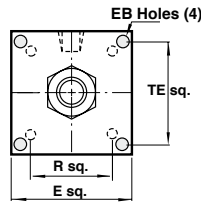

Bore	7"	8"	10"	12"
E	7.500	8.500	10.625	12.750
EB	.563	.688	.813	.813
R	5.730	6.442	8.004	9.406
TE	6.750	7.570	9.406	11.109

NFPA (ME4) 04 Cap Square Mount

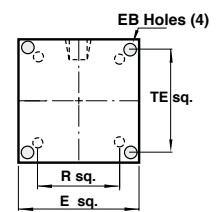

Bore	7"	8"	10"	12"
E	7.500	8.500	10.625	12.750
EB	.563	.688	.813	.813
R	5.730	6.442	8.004	9.406
TE	6.750	7.570	9.406	11.109

NFPA (MX1) 06 (4) Extended Tie Rods Both Ends Mount

NFPA (MX2) 6C Cap Tie Rods Extended Mount

NFPA (MX3) 6R Head Tie Rods Extended Mount

NFPA (MX4) 6B (2) Extended Tie Rods Both Ends Mount

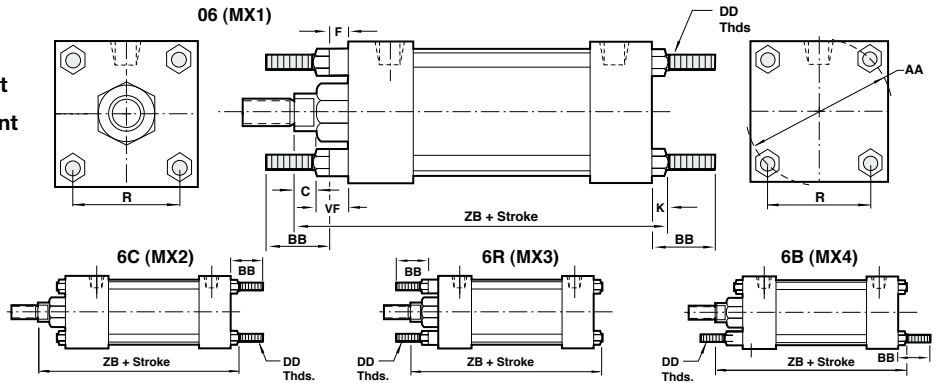

Bore	1-1/2"	2"	2-1/2"	3-1/4"	4"	5"	6"	7"	8"	10"	12"
AA	2.020	2.600	3.100	3.900	4.700	5.800	6.900	8.100	9.100	11.313	13.313
BB	1.000	1.125	1.125	1.375	1.375	1.813	1.813	2.313	2.313	2.688	2.688
C	Std. .375	.375	.375	.500	.500	.500	.625	.625	.625	.750	.875
O.S.	.500	.500	.500	.625	.625	.625	.750	.625	.750	.875	1.000
DD	1/4 - 28	5/16 - 24	5/16 - 24	3/8 - 24	3/8 - 24	1/2 - 20	1/2 - 20	5/8 - 18	5/8 - 18	3/4 - 16	3/4 - 16
F	.375	.375	.375	.625	.625	.625	.750	—	—	—	—
K	.250	.313	.313	.375	.375	.438	.438	.563	.563	.688	.688
R	1.428	1.838	2.192	2.758	3.323	4.101	4.879	5.730	6.442	8.004	9.406
VF	Std. .625	.625	.625	.875	.875	.875	1.000	1.000	1.000	1.125	1.125
O.S.	.875	.875	.875	1.000	1.000	1.000	1.125	1.125	1.125	1.125	1.250
ZB	Std. 4.875	4.938	5.063	6.000	6.000	6.313	7.063	7.313	7.313	8.938	9.563
O.S.	5.250	5.313	5.438	6.250	6.250	6.563	7.313	7.563	7.563	9.063	9.813

All dimensions ± .015 unless otherwise noted.

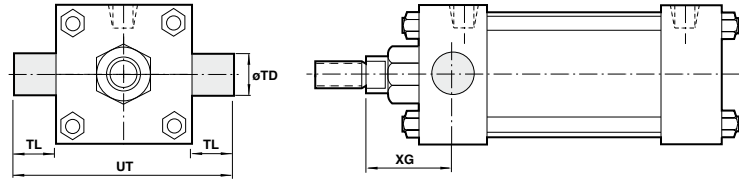
NFPA (MT1) 7R & 07 Head Trunnion Mount

Bore	1-1/2"	2"	2-1/2"	3-1/4"	4"	5"	6"	7"	8"	10"	12"
TD +.000 -.001	1.000	1.000	1.000	1.000	1.000	1.000	1.375	1.375	1.375	1.750	1.750
TL	1.000	1.000	1.000	1.000	1.000	1.000	1.375	1.375	1.375	1.750	1.750
UT	4.000	4.500	5.000	5.750	6.500	7.500	9.250	10.250	11.250	14.125	16.250
XG Std.	1.750	1.750	1.750	2.250	2.250	2.250	2.625	2.625	2.625	3.000	3.125
O.S.	2.125	2.125	2.125	2.500	2.500	2.500	2.875	2.875	2.875	3.125	3.375

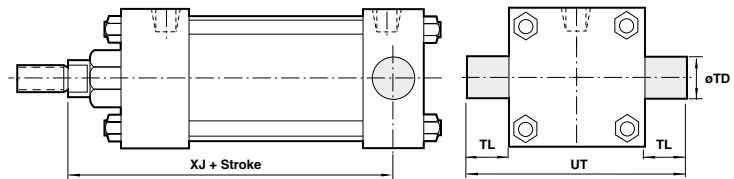
NFPA (MT2) 8R & 08 Cap Trunnion Mount

Bore	1-1/2"	2"	2-1/2"	3-1/4"	4"	5"	6"	7"	8"	10"	12"
TD +.000 -.001	1.000	1.000	1.000	1.000	1.000	1.000	1.375	1.375	1.375	1.750	1.750
TL	1.000	1.000	1.000	1.000	1.000	1.000	1.375	1.375	1.375	1.750	1.750
UT	4.000	4.500	5.000	5.750	6.500	7.500	9.250	10.250	11.250	14.125	16.250
XG Std.	4.125	4.125	4.250	5.000	5.000	5.250	5.875	6.000	6.000	7.250	7.875
O.S.	4.500	4.500	4.625	5.250	5.250	5.500	6.125	6.250	6.250	7.375	8.125

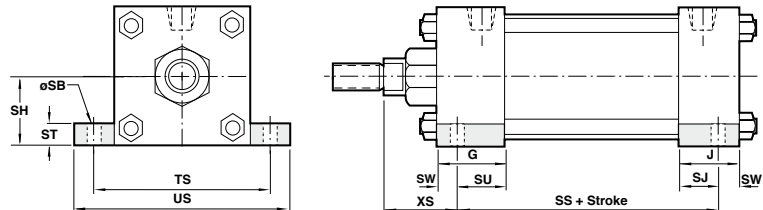
NFPA (MS2) 09 Side Lug Mount

Bore	1-1/2"	2"	2-1/2"	3-1/4"	4"	5"	6"	7"	8"	10"	12"
G	1.500	1.500	1.500	1.750	1.750	1.750	2.000	2.000	2.000	2.250	2.250
J	1.000	1.000	1.000	1.250	1.250	1.250	1.500	1.500	1.500	2.000	2.000
SB	.438	.438	.438	.563	.563	.813	.813	.813	.813	1.063	1.063
SH	1.000	1.250	1.500	1.875	2.250	2.750	3.250	3.750	4.250	5.313	6.375
SJ	.625	.625	.625	.750	.750	.813	.813	.813	.813	2.000	2.000
SS	2.875	2.875	3.000	3.250	3.250	3.125	3.625	3.750	3.750	4.625	5.125
ST	.500	.500	.500	.750	.750	1.000	1.000	1.000	1.000	1.250	1.250
SU	1.125	1.125	1.125	1.250	1.250	1.063	1.563	1.563	1.563	2.000	2.000
SW	.375	.375	.375	.500	.500	.688	.688	.688	.688	.875	.875
TS	2.750	3.250	3.750	4.750	5.500	6.875	7.875	8.875	9.875	12.375	14.500
US	3.500	4.000	4.500	5.750	6.500	8.250	9.250	10.250	11.250	14.125	16.250
XS Std.	1.375	1.375	1.375	1.875	1.875	2.062	2.313	2.313	2.313	2.750	2.875
O.S.	1.750	1.750	1.750	2.125	2.125	2.313	2.562	2.563	2.563	2.875	3.125

All dimensions ± .015 unless otherwise noted.

NFPA (MT4) 10 Center Trunnion Mount

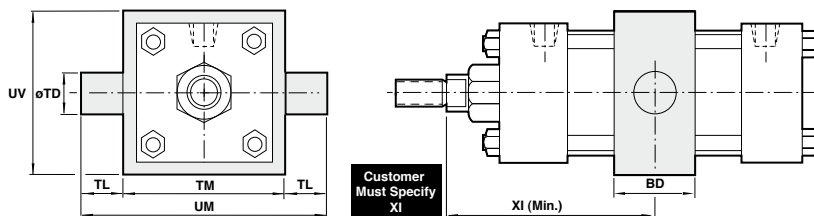

Bore	1-1/2"	2"	2-1/2"	3-1/4"	4"	5"	6"	7"	8"	10"	12"
BD	1.250	1.500	1.500	2.000	2.000	2.000	2.500	2.500	2.500	3.000	3.000
TD +.000 -.001	1.000	1.000	1.000	1.000	1.000	1.000	1.375	1.375	1.375	1.750	1.750
TL	1.000	1.000	1.000	1.000	1.000	1.000	1.375	1.375	1.375	1.750	1.750
TM	2.500	3.000	3.500	4.500	5.250	6.250	7.625	8.750	9.750	12.000	14.000
UM	4.500	5.000	5.500	6.500	7.250	8.250	10.375	11.500	12.500	15.500	17.500
UV	2.500	3.000	3.500	4.250	5.000	6.000	7.000	8.500	9.500	11.750	13.750
XI min. Std.	3.125	3.250	3.250	4.125	4.125	4.125	4.625	4.875	4.875	5.625	5.750
O.S.	3.500	3.625	3.625	4.375	4.375	4.375	4.875	5.125	5.125	5.750	6.000

NFPA (MS1) 11 Side End Angle Mount

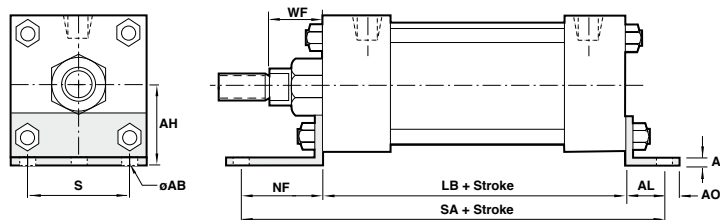

Bore	1-1/2"	2"	2-1/2"	3-1/4"	4"	5"	6"	7"	8"	10"	12"
AB	.438	.438	.438	.563	.563	.688	.813	.813	.813	1.063	1.063
AH	1.188	1.438	1.625	1.938	2.250	2.750	3.250	3.750	4.250	5.313	6.375
AL	1.000	1.000	1.000	1.250	1.250	1.375	1.375	1.813	1.813	2.125	2.125
AO	.375	.375	.375	.500	.500	.625	.625	.688	.688	.875	.875
AT	.125	.125	.125	.125	.125	.187	.187	.250	.250	.250	.250
LB	3.625	3.625	3.750	4.250	4.250	4.500	5.000	5.125	5.125	6.375	6.875
NF	1.375	1.375	1.375	1.875	1.875	2.000	2.125	1.813	1.813	1.813	1.813
S	1.250	1.750	2.250	2.750	3.500	4.250	5.250	6.125	7.125	8.875	11.000
SA	6.000	6.000	6.125	7.375	7.375	7.875	8.500	8.750	8.750	10.625	11.125
WF STD.	1.000	1.000	1.000	1.375	1.375	1.375	1.625	1.625	1.625	1.875	2.000
O.S.	1.375	1.375	1.375	1.625	1.625	1.625	1.875	1.875	1.875	2.000	2.250

NFPA (MP1) 12 Cap Fixed Clevis Mount

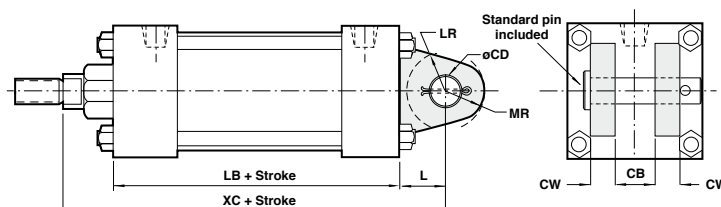

Bore	1-1/2"	2"	2-1/2"	3-1/4"	4"	5"	6"	7"	8"	10"	12"
CB	.750	.750	.750	1.250	1.250	1.250	1.500	1.500	1.500	2.000	2.500
CD	.500	.500	.500	.750	.750	.750	1.000	1.000	1.000	1.375	1.750
CW	.500	.500	.500	.625	.625	.625	.750	.750	.750	1.000	1.250
L	.750	.750	.750	1.250	1.250	1.250	1.500	1.500	1.500	2.125	2.250
LB	3.625	3.625	3.750	4.250	4.250	4.500	5.000	5.125	5.125	6.375	6.875
LR	.750	.750	.750	1.250	1.250	1.250	1.500	1.500	1.500	1.875	2.125
MR	.625	.625	.625	.938	.938	.938	1.188	1.188	1.188	1.625	2.125
XC Std.	5.375	5.375	5.500	6.875	6.875	7.125	8.125	8.250	8.250	10.375	11.125
O.S.	5.750	5.750	5.875	7.125	7.125	7.375	8.375	8.500	8.500	10.500	11.375

All dimensions ± .015 unless otherwise noted.

NFPA (MS7) 15 End Lug Mount

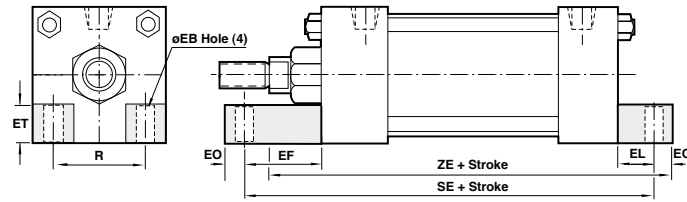

Bore	1-1/2"	2"	2-1/2"	3-1/4"	4"	5"	6"	7"	8"
EB	.313	.375	.375	.438	.438	.563	.563	.688	.688
EF	1.125	1.313	1.438	1.500	1.625	1.688	1.750	1.750	1.125
EL	.750	.938	1.063	.875	1.000	1.063	1.000	1.125	1.125
EO	.250	.313	.313	.375	.375	.500	.500	.625	.625
ET	.500	.750	.750	1.000	1.250	1.500	1.500	1.750	2.063
R	1.428	1.838	2.192	2.758	3.323	4.101	4.879	5.730	6.442
ZE	5.500	5.875	6.250	6.625	6.875	7.250	7.750	7.375	7.375
SE Std.	5.625	5.875	6.125	6.875	7.000	7.438	8.125	8.500	8.500
O.S.	6.000	6.250	6.500	7.125	7.250	7.688	8.375	8.750	8.750

16 Sleeve Nut Construction Side Tapped (Universal Mount)

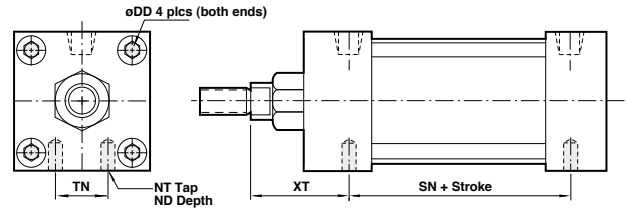

Bore	1-1/2"	2"	2-1/2"	3-1/4"	4"	5"	6"
BB	.500	.500	.500	.625	.625	.625	.750
DD	1/4-28	5/16-24	5/16-24	3/8-24	3/8-24	1/2-20	1/2-20
NT	1/4-20	5/16-18	3/8-16	1/2-13	1/2-13	5/8-11	3/4-10
ND	.375	.375	.500	.750	.750	.938	1.125
R	1.428	1.838	2.192	2.758	3.323	4.101	4.879
SN	2.250	2.250	2.375	2.625	2.625	2.875	3.125
TN	.625	.875	1.250	1.500	2.063	2.688	3.250
XT Std.	1.938	1.938	1.938	2.438	2.438	2.438	2.813
O.S.	2.313	2.313	2.313	2.688	2.688	2.688	3.063

NFPA (MF5) 20 Head Square Flange Mount

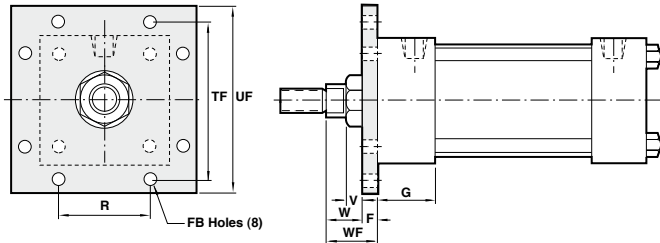

Bore	1-1/2"	2"	2-1/2"	3-1/4"	4"	5"	6"
F	.375	.375	.375	.625	.625	.625	.750
FB	.313	.375	.375	.438	.438	.563	.563
G	1.500	1.500	1.500	1.750	1.750	1.750	2.000
R	1.428	1.838	2.192	2.758	3.323	4.101	4.879
TF	2.750	3.375	3.875	4.688	5.438	6.625	7.625
UF	3.375	4.125	4.625	5.500	6.250	7.625	8.625
V Std.	.250	.250	.250	.250	.250	.250	.250
O.S.	.500	.500	.500	.375	.375	.375	.375
W Std.	.625	.625	.625	.750	.750	.750	.875
O.S.	1.000	1.000	1.000	1.000	1.000	1.000	1.125
WF Std.	1.000	1.000	1.000	1.375	1.375	1.375	1.625
O.S.	1.375	1.375	1.375	1.625	1.625	1.625	1.875

NFPA (MF6) 21 Cap Square Flange Mount

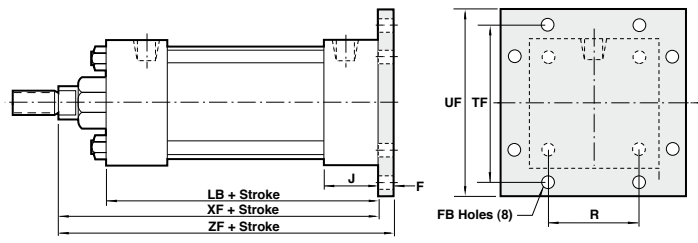

Bore	1-1/2"	2"	2-1/2"	3-1/4"	4"	5"	6"
F	.375	.375	.375	.625	.625	.625	.750
FB	.313	.375	.375	.438	.438	.563	.563
J	1.000	1.000	1.000	1.250	1.250	1.250	1.500
LB	3.625	3.625	3.750	4.250	4.250	4.500	5.000
R	1.428	1.838	2.192	2.758	3.323	4.101	4.879
TF	2.750	3.375	3.875	4.688	5.438	6.625	7.625
UF	3.375	4.125	4.625	5.500	6.250	7.625	8.625
XF Std.	4.625	4.625	4.750	5.625	5.625	5.875	6.625
O.S.	5.000	5.000	5.125	5.875	5.875	6.125	6.875
ZF Std.	5.000	5.000	5.125	6.250	6.250	6.500	7.375
O.S.	5.375	5.375	5.500	6.500	6.500	6.750	7.625

NFPA (MP2) 22 Detachable Cap Clevis Mount

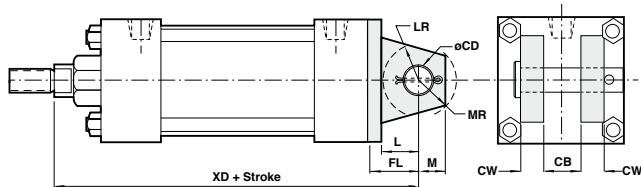

Bore	1-1/2"	2"	2-1/2"	3-1/4"	4"	5"	6"	7"	8"
CB	.750	.750	.750	1.250	1.250	1.250	1.500	1.500	1.500
CD	.500	.500	.500	.750	.750	.750	1.000	1.000	1.000
CW	.500	.500	.500	.625	.625	.625	.750	.750	.750
FL	1.125	1.125	1.125	1.875	1.875	1.875	2.250	2.250	2.250
L	.750	.750	.750	1.250	1.250	1.250	1.500	1.500	1.500
LR	.750	.750	.750	1.250	1.250	1.250	1.500	1.500	1.500
M	.500	.500	.500	.750	.750	.750	1.000	1.000	1.000
MR	.625	.625	.625	.938	.938	.938	1.188	1.188	1.188
XD Std.	5.750	5.750	5.875	7.500	7.500	7.750	8.875	9.000	9.000
O.S.	6.125	6.125	6.250	7.750	7.750	8.000	9.125	9.250	9.250

NFPA (MP4) 42 Detachable Cap Eye Mount

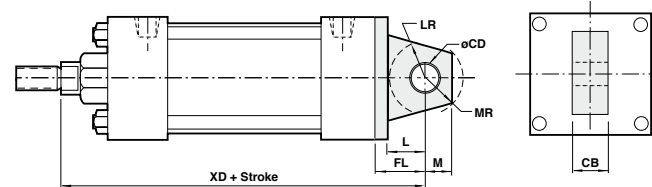

Bore	1-1/2"	2"	2-1/2"	3-1/4"	4"	5"	6"	7"	8"
CB	.750	.750	.750	1.250	1.250	1.250	1.500	1.500	1.500
CD	.500	.500	.500	.750	.750	.750	1.000	1.000	1.000
FL	1.125	1.125	1.125	1.875	1.875	1.875	2.250	2.250	2.250
L	.750	.750	.750	1.250	1.250	1.250	1.500	1.500	1.500
LR	.750	.750	.750	1.250	1.250	1.250	1.500	1.500	1.500
M	.500	.500	.500	.750	.750	.750	1.000	1.000	1.000
MR	.625	.625	.625	.938	.938	.938	1.188	1.188	1.188
XD Std.	5.750	5.750	5.875	7.500	7.500	7.750	8.875	9.000	9.000
O.S.	6.125	6.125	6.250	7.750	7.750	8.000	9.125	9.250	9.250

All dimensions ± .015 unless otherwise noted.

NFPA (MP3) 32 Cap Fixed Eye

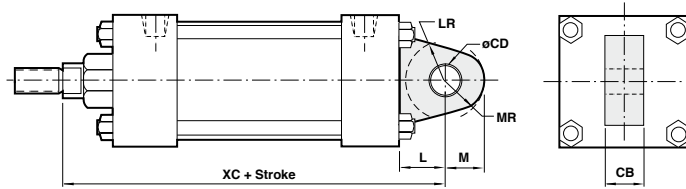

Bore	1-1/2"	2"	2-1/2"	3-1/4"	4"	5"	6"	7"	8"	10"	12"
CB	.750	.750	.750	1.250	1.250	1.250	1.500	1.500	1.500	2.000	2.500
CD	.500	.500	.500	.750	.750	.750	1.000	1.000	1.000	1.375	1.750
L	.750	.750	.750	1.250	1.250	1.250	1.500	1.500	1.500	2.125	2.250
LR	.750	.750	.750	1.250	1.250	1.250	1.500	1.500	1.500	1.875	2.125
M	.500	.500	.500	.750	.750	.750	1.000	1.000	1.000	1.375	1.750
MR	.625	.625	.625	.938	.938	.938	1.188	1.188	1.188	1.625	2.125
XC Std.	5.375	5.375	5.500	6.875	6.875	7.125	8.125	8.250	8.250	10.375	11.125
O.S.	5.750	5.750	5.875	7.125	7.125	7.375	8.375	8.500	8.500	10.500	11.375

52 (Not NFPA) Spherical Bearing Mount

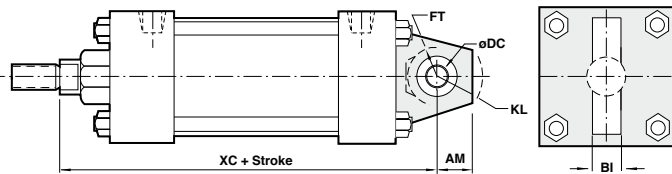

Bore	1-1/2"	2"	2-1/2"	3-1/4"	4"	5"	6"	7"	8"
AM	.750	.750	.750	1.000	1.000	1.000	1.250	1.250	1.250
BI	.438	.438	.438	.656	.656	.656	.875	.875	.875
CB	.375	.375	.375	.562	.562	.562	.75	.75	.75
DC	.500	.500	.500	.750	.750	.750	1.000	1.000	1.000
FT	.625	.625	.625	1.000	1.000	1.000	1.250	1.250	1.250
KL	.969	.969	.969	1.406	1.406	1.406	1.719	1.719	1.719
XC Std.	5.375	5.375	5.500	6.875	6.875	7.125	8.125	8.250	8.250
O.S.	5.750	5.750	5.875	7.125	7.125	7.375	8.375	8.500	8.500

60 Base (Not NFPA) Bar Mount

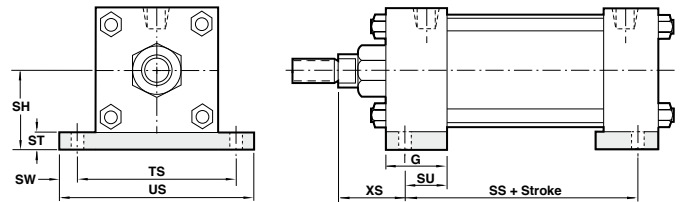

Bore	1-1/2"	2"	2-1/2"	3-1/4"	4"	5"	6"
G	1.500	1.500	1.500	1.750	1.750	1.750	2.000
SH	1.250	1.500	1.875	2.375	2.750	3.500	4.000
SS	2.875	2.875	3.000	3.250	3.250	3.125	3.625
ST	.250	.250	.375	.500	.500	.750	.750
SU	1.125	1.125	1.125	1.250	1.250	1.063	1.313
SW	.375	.375	.375	.500	.500	.688	.688
TS	2.750	3.250	3.750	4.750	5.500	6.875	7.875
US	3.500	4.000	4.500	5.750	6.500	8.250	9.250
XS Std.	1.375	1.375	1.375	1.875	1.875	2.063	2.313
O.S.	1.750	1.750	1.750	2.125	2.125	2.313	2.563

NFPA (MX0) 05 Basic with Double Rod End Cylinder

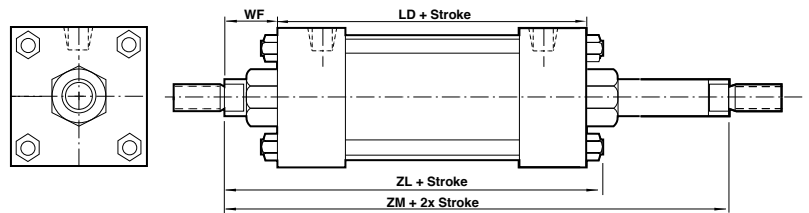

Bore	1-1/2"	2"	2-1/2"	3-1/4"	4"	5"	6"	7"	8"	10"	12"
LD	4.125	4.125	4.250	4.750	4.750	5.000	5.500	5.625	5.625	6.625	7.125
WF Std.	1.000	1.000	1.000	1.375	1.375	1.375	1.625	1.625	1.625	1.875	2.000
O.S.	1.375	1.375	1.375	1.625	1.625	1.625	1.875	1.875	1.875	2.000	2.250
ZL Std.	5.375	5.438	5.563	6.500	6.500	6.813	7.563	7.813	7.813	10.375	11.125
O.S.	5.750	5.813	5.938	6.750	6.750	7.063	7.813	8.125	8.125	10.625	11.625
ZM Std.	6.125	6.125	6.250	7.500	7.500	7.750	8.750	8.875	8.875	9.250	9.675
O.S.	6.875	6.875	7.000	8.000	8.000	8.250	9.250	9.375	9.375	9.375	10.375

All dimensions ± .015 unless otherwise noted.

NFPA Rod Clevis

Note: Rod Clevis Assembly 49102A and 49103A are supplied with NFPA Pin. All others are with Standard Pin

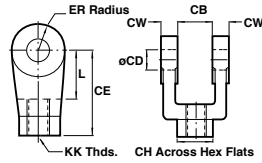

Rod Clevis	Rod Clevis Assy.	KK	CB	CD	CE	CH	CW	ER	L
49028	49028A	7/16 - 20	.750	.500	1.500	1.000	.500	.500	.750
49029	49029A	1/2 - 20	.750	.500	1.500	1.000	.500	.500	.750
49097	49097A	5/8 - 18	.750	.500	1.500	1.000	.500	.500	.750
49030	49030A	3/4 - 16	1.250	.750	2.375	1.250	.625	.750	1.250
49098	49098A	7/8 - 14	1.250	.750	2.375	1.250	.625	.750	1.250
49032	49032A	1 - 14	1.500	1.000	3.125	1.500	.750	1.000	1.500
49033	49033A	1-1/4 - 12	2.000	1.375	4.125	2.000	1.000	1.375	2.125
49099	49099A	1-3/8 - 12	2.000	1.375	4.125	2.000	1.000	1.000	2.125
49034	49034A	1-1/2 - 12	2.500	1.750	4.500	2.375	1.250	1.750	2.250
49100	49100A	1-3/4 - 12	2.500	1.750	4.500	2.375	1.250	1.750	2.250
49036	49036A	1-7/8 - 12	2.500	2.000	5.500	2.937	1.250	2.000	2.500
49101	49101A	2 - 12	2.500	2.000	5.500	2.937	1.250	2.000	2.500
49102	49102A	2-1/4 - 12	3.000	2.500	6.500	3.500	1.500	2.750	3.000
49103	49103A	2-1/2 - 12	3.000	3.000	6.750	3.875	1.500	2.750	3.250

Small Rod Clevis & Jam Nut

Note: Rod Clevis Assembly is supplied with Jam Nut and Standard Pin.

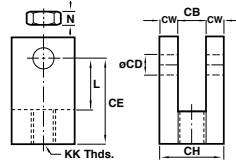

Rod Clevis	Rod Clevis Assy.	KK	CB	CD	CE	CH	CW	L	N
49218	49218A	1/2 - 20	.500	.500	1.375	1.000	.250	.750	.375
49219	49219A	3/4 - 16	.750	.750	1.750	1.500	.375	1.000	.500

Rod Jam Nut

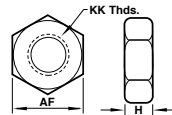

52025	52026	52027	52010	52029	52030	52085
KK 7/16 - 20	1/2 - 20	5/8 - 18	3/4 - 16	7/8 - 14	1 - 14	1-1/4 - 12
AF .688	.750	.938	1.125	1.313	1.500	1.875
H .250	.313	.375	.422	.484	.547	.719
52092	52068	52082	52070	52093	52083	52075
KK 1-3/8 - 12	1-1/2 - 12	1-3/4 - 12	1-7/8 - 12	2 - 12	2-1/4 - 12	2-1/2 - 12
AF 2.063	2.250	2.625	2.938	3.125	3.500	3.875
H .781	.844	.969	1.031	1.094	1.203	1.453

NFPA Rod Eye

Note: Rod Eye Assembly 49062A and 49096A are supplied with NFPA Pin. All others are supplied with Standard Pin

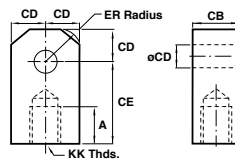

Rod Eye	Rod Eye Assy.	KK	A	CB	CD	CE	ER
49015	49015A	7/16 - 20	.750	.750	.500	1.500	.563
49014	49014A	1/2 - 20	.750	.750	.500	1.500	.563
49091	49091A	5/8 - 18	.750	1.250	.750	2.063	.500
49013	49013A	3/4 - 16	1.125	1.250	.750	2.063	.938
49092	49092A	7/8 - 14	1.125	1.250	.750	2.063	.750
49011	49011A	1 - 14	1.625	1.500	1.000	2.813	1.125
49010	49010A	1-1/4 - 12	2.000	2.000	1.375	3.438	1.563
49093	49093A	1-3/8 - 12	1.625	2.000	1.375	3.438	1.375
49009	49009A	1-1/2 - 12	2.250	2.500	1.750	4.000	2.500
49094	49094A	1-3/4 - 12	2.250	2.500	1.750	4.000	2.500
49007	49007A	1-7/8 - 12	3.000	2.500	2.000	5.000	2.875
49095	49095A	2 - 12	2.250	2.500	2.000	5.000	2.875
49062	49062A	2-1/4 - 12	3.000	3.000	2.500	5.813	3.250
49096	49096A	2-1/2 - 12	3.000	3.000	3.000	6.125	3.250

Spherical Rod Eye

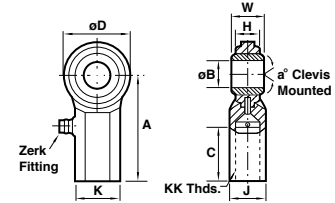

Spherical Rod Eye	49220	49221	49222
Spherical Rod Eye Assy.	49220A	49221A	49222A 6 & 8
Bore	1-1/2, 2 & 2-1/2	3-1/4, 4 & 5	1 - 14
KK UNF-2B	1/2 - 20	3/4 - 16	1 - 14
a° Misalignment Angle	12	14	14
A ± .015	2.125	2.875	4.125
B + .0025 / -.0005	.500	.750	1.000
C + .062 / -.031	1.063	1.563	2.125
D ± .010	1.313	1.750	2.750
H Reference	.453	.593	1.000
J ± .010	.750	1.000	1.500
K ± .010	.875	1.125	1.625
W + .000 / -.005	.625	.875	1.375

NFPA Eye Bracket

Note: NFPA Eye Bracket Assembly is supplied with Standard Pin.

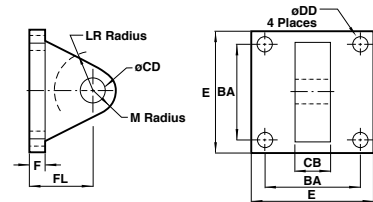

NFPA EyeBracket	49021	49020	49019	49016	49017	49018
Eye Bracket Assembly	49021A	49020A	49019A	49016A	49017A	49018A
BA	1.625	2.563	3.250	3.813	4.937	5.750
CB	.750	1.250	1.500	2.000	2.500	2.500
CD	.500	.750	1.000	1.375	1.750	2.000
DD	.406	.531	.656	.656	.906	1.062
E	2.500	3.500	4.500	5.000	6.500	7.500
F	.375	.625	.750	.875	.875	1.000
FL	1.125	1.875	2.250	3.000	3.125	3.500
LR	.750	1.250	1.500	2.125	2.250	2.500
M	.500	.750	1.000	1.375	1.750	2.000

Norgren Eye Bracket

Note: Norgren Eye Bracket Assembly is supplied with Standard Pin.

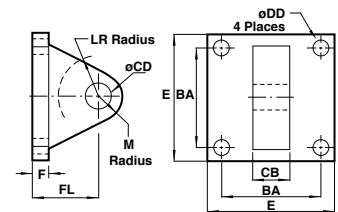

Eye Bracket	49240	49241	49242	49243	49244	49019	49016	49017	49018
Eye Bracket Assembly	49240A	49241A	49242A	49243A	49244A	49019A	49016A	49017A	49018A
BA	1.438	1.844	2.188	2.938	3.563	3.250	3.813	4.950	5.730
CB	.750	.750	.750	1.250	1.250	1.500	2.000	2.500	2.500
CD	.500	.500	.500	.750	.750	1.000	1.375	1.750	2.000
DD	.281	.344	.344	.469	.469	.656	.656	.906	1.062
E	2.000	2.500	3.000	3.750	4.500	4.500	5.000	6.500	7.500
F	.375	.375	.375	.500	.500	.750	.875	.875	1.000
FL	1.125	1.125	1.125	1.750	1.750	2.250	3.000	3.125	3.500
LR	.563	.563	.563	1.000	1.000	1.500	2.125	2.250	2.500
M	.625	.625	.625	.875	.875	1.000	1.375	1.750	2.000

All dimensions ± .015 unless otherwise noted.

NFPA Clevis Bracket

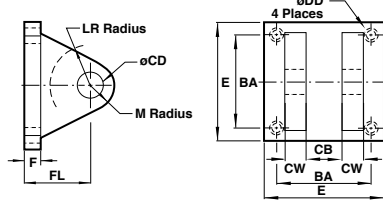

Note: NFPA Clevis Bracket Assembly is supplied with Standard Pin.

NFPA Clevis Bracket	49250	49251	49252
Clevis Bracket Assembly	49250A	49251A	49252A
BA	1.625	2.563	3.250
CB	.750	1.250	1.500
CD	.500	.750	1.000
CW	.500	.625	.750
DD	3/8 – 24	1/2 – 20	5/8 – 18
E	2.500	3.500	4.500
F	.375	.625	.750
FL	1.125	1.875	2.250
LR	.750	1.250	1.500
M	.500	.813	1.000

Norgren Clevis Bracket

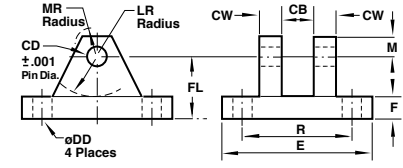

Note: Norgren Clevis Bracket Assembly is supplied with Standard Pin.

Norgren Clevis Bracket Clevis	49022	49023	49024	49027	49025	49026
Bracket Assembly	49022A	49023A	49024A	49027A	49025A	49026A
CB	.750	1.250	1.500	2.000	2.500	2.500
CD	.500	.750	1.000	1.375	1.750	2.000
CW	.500	.625	.750	1.000	1.250	1.500
DD	.406	.531	.656	.656	.906	1.026
E	3.500	5.000	6.500	8.000	10.000	12.000
F	.500	.625	.750	.875	.875	1.000
FL	1.500	1.875	2.250	3.000	3.625	4.520
LR	.750	1.188	1.500	2.000	2.750	3.188
M	.500	.750	1.000	1.375	1.750	2.250
MR	.625	.906	1.250	1.656	2.219	2.781
R	2.547	3.828	4.953	5.734	7.500	9.938

NFPA Pin

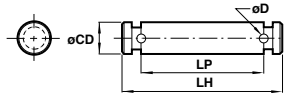

Note: ø.500, .750, 1.000 are Retainer type design ø1.375 and larger are Cotter Pin design.

NFPA Pin	49006-R	49005-R	49004-R	49003	49002	49001	49000	49126	49127
CD	.500	.750	1.000	1.375	1.750	2.000	2.000	2.500	3.000
LH	2.219	3.125	3.750	4.656	5.812	5.812	6.312	6.875	6.875
LP	1.875	2.750	3.250	4.250	5.250	5.281	5.770	6.312	6.344
D	-	-	-	.173	.173	.204	.204	.219	.250

Standard Pin

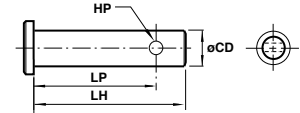

Std. Pin	49207*	49208*	49206	49205	49204	49203	49202	49201
CD	.500	.750	.500	.750	1.000	1.375	1.750	2.000
HP	.156	.156	.156	.156	.203	.250	.250	.250
LH	1.421	2.000	2.250	3.000	3.500	5.000	6.000	6.000
LP	1.266	1.843	2.093	2.843	3.297	4.500	5.500	5.500

* For small rod clevis only.

Rod Alignment Coupler

The Rod Alignment Coupler allows 1/16" of radial float and 2° of spherical movement. This prevents cylinder binding due to misalignment thus extending bearing and seal life, and permits greater tolerance between the centerline of the cylinder and mating part for simplified installation.

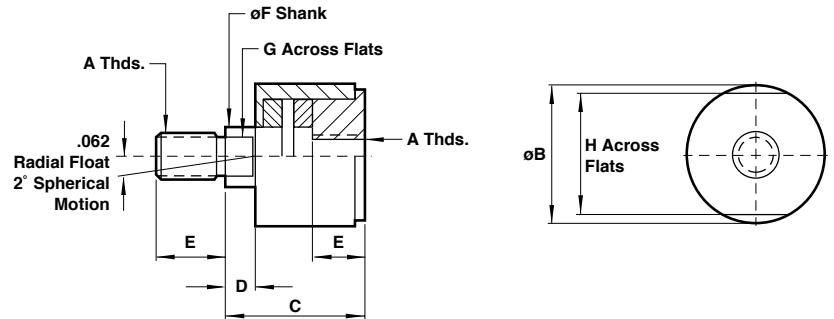

Rod Alignment Coupler Dimensions

	CC-1-07 7/16 – 20	CC-1-08 1/2 – 20	CC-1-10 5/8 – 18	CC-1-12 3/4 – 16	CC-1-14 7/8 – 14	CC-1-16 1 – 14	CC-1-20 1-1/4 – 12	CC-1-24 1-1/2 – 12	CC-1-28 1-3/4 – 12
A	1.250 (31.75)	1.250 (31.75)	1.250 (31.75)	1.750 (44.45)	1.750 (44.45)	2.500 (63.50)	2.500 (63.50)	3.250 (82.50)	3.250 (82.50)
B	2.000 (50.80)	2.000 (50.80)	2.000 (50.80)	2.312 (58.72)	2.312 (58.72)	2.937 (74.60)	2.937 (74.60)	4.375 (111.13)	4.375 (111.13)
C	.500 (12.70)	.500 (12.70)	.500 (12.70)	.500 (12.70)	.500 (12.70)	.500 (12.70)	.500 (12.70)	.812 (20.62)	.812 (20.62)
D	.750 (19.05)	.750 (19.05)	.750 (19.05)	1.125 (28.58)	1.125 (28.58)	1.625 (41.28)	1.625 (41.28)	2.250 (57.15)	2.250 (57.15)
E	.625 (28.58)	.625 (28.58)	.625 (28.58)	.969 (24.61)	.969 (24.61)	1.375 (34.93)	1.375 (34.93)	1.750 (44.45)	1.750 (44.45)
F	.500 (12.70)	.500 (12.70)	.500 (12.70)	.812 (20.62)	.812 (20.62)	1.156 (29.36)	1.156 (29.36)	1.500 (38.10)	1.500 (38.10)
G	1.125 (28.58)	1.125 (28.58)	1.125 (28.58)	1.500 (38.10)	1.500 (38.10)	2.250 (57.15)	2.250 (57.15)	3.000 (76.20)	3.000 (76.20)
H	10,000	14,000	19,000	34,000	39,000	64,000	78,000	134,000	134,000
Max Pull (lbs.)									

All dimensions ± .015 unless otherwise noted.

Air-Oil Tank

Available in 5 practical bore sizes: 1-1/8", 2", 3-1/4", 5", and 8", the Air-Oil Tank includes a translucent fiberglass tube which permits viewing of the tank oil level from any position, internal baffles that reduce foaming and aeration of the system oil resulting in maximum cylinder control, and standard angle mounting brackets (except 1-1/8" bore) easily removed for convenient fluid port positioning.

How to Figure Length of Volume

Use these equations to select the right air/oil tank volume for your particular application.

Volume of Cylinder:

Cap End Cylinder Bore Area x Stroke = Volume

Head End Cylinder Bore Area - (Piston Rod Area) x Stroke = Volume

Length of Tank = $\frac{\text{Volume of Cylinder} \times 1.3^*}{\text{Tank Bore Area}}$

(See chart below.) *30% minimum recommended reserve working volume.

Final Length of Volume of Tank = Working length of tank + 2" minimum safety factor to prevent aeration of oil. Note: Length must be at least 3".

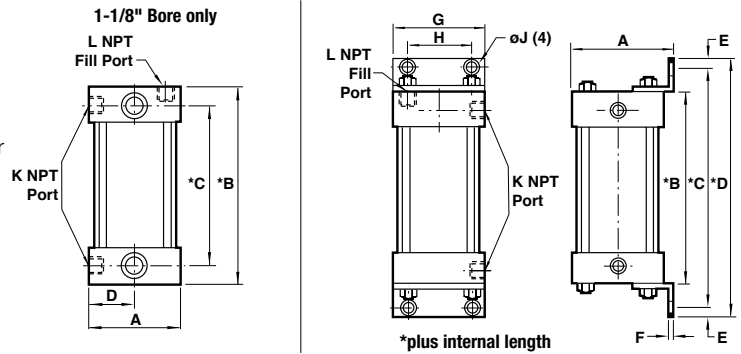

Air-Oil Tank Dimensions

Bore	1-1/8"	2"	3-1/4"	5"	8"
	AOT-225	AOT-04	AOT-065	AOT-10	AOT-16
A	1.500 (38.10)	2.687 (68.25)	4.000 (101.60)	5.625 (142.88)	8.625 (219.08)
B	1.250 (31.75)	2.000 (50.80)	2.500 (63.50)	2.500 (63.50)	3.000 (76.20)
C	.750 (19.05)	4.000 (101.60)	5.000 (127.00)	5.250 (127.00)	6.625 (168.28)
D	.750 (19.05)	4.750 (120.65)	6.000 (152.40)	6.500 (152.40)	8.000 (203.20)
E		.375 (9.53)	.500 (12.70)	.500 (12.70)	.687 (17.45)
F		.125 (3.18)	.187 (4.75)	.187 (4.75)	.250 (6.35)
G		2.500 (63.50)	3.750 (95.25)	5.500 (139.70)	8.500 (215.90)
H		1.750 (44.45)	2.750 (69.85)	4.25 (107.95)	7.125 (180.98)
øJ		.437 (11.10)	.562 (14.27)	.690 (17.53)	.812 (20.62)
K	.125 (3.18)	.375 (9.53)	.500 (12.70)	.500 (12.70)	.750 (19.05)
L	.125 (3.18)	.250 (6.35)	.375 (9.53)	.375 (9.53)	.500 (12.70)

Note: Maximum operating pressure 250 PSI.

Air-Oil Tank Volumes (cubic inches)

Internal Length of Tank	Bore Area	1-1/8"	2"	3-1/4"	5"	8"
		.995 sq."	3.14 sq."	8.30 sq."	19.64 sq."	50.26 sq."
6"	5.9	18.6	49.8	117.8	301.5	
8"	7.9	25.1	66.4	157.1	402.0	
10"	9.9	31.4	83.0	196.4	502.6	
12"	11.9	37.6	99.6	235.6	603.1	
14"	13.9	43.9	116.2	274.9	703.6	
16"	15.9	50.2	132.8	314.2	804.1	
18"	17.9	56.5	149.4	353.5	904.5	
20"	19.9	62.8	166.0	392.8	1005.2	

How to Order: Specify air-oil tank part number and internal length.
Example: 2" bore with 6" internal length = AOT-04 x 6

Cylinder Force and Volume Charts Extend Forces in pounds (newtons)

All Dimensions in Inches (mm)
All Forces in Pounds (Newtons)

Bore	Piston Area	Pressure PSIG (bar)								Volume Cu ft³ (cm³) Displacement Per Inch
		40 (3)	60 (4)	80 (6)	100 (7)	150 (10)	200 (14)			
1-1/2"	1.77 (11.40)	71 (315)	106 (472)	142 (629)	177 (786)	266 (1179)	353 (1570)	.00102 (29)		
2"	3.14 (20.27)	126 (559)	189 (839)	251 (1119)	314 (1398)	471 (2097)	628 (2793)	.00182 (52)		
2-1/2"	4.91 (31.67)	196 (874)	295 (1311)	393 (1748)	491 (2185)	737 (3277)	982 (4368)	.00284 (80)		
3-1/4"	8.30 (53.32)	332 (1477)	498 (2215)	664 (2953)	830 (3692)	1245 (5538)	1659 (7379)	.00480 (136)		
4"	12.57 (81.07)	503 (2237)	754 (3355)	1005 (4473)	1257 (5592)	1886 (8388)	2513 (11178)	.00727 (206)		
5"	19.64 (126.71)	785 (3491)	1178 (5240)	1571 (6988)	1964 (8736)	2946 (13104)	3928 (17472)	.01137 (322)		
6"	28.27 (182.39)	1130 (5026)	1696 (7544)	2262 (10061)	2827 (12574)	4240 (18860)	5654 (25149)	.01636 (463)		
7"	38.49 (247.91)	1540 (6831)	2309 (10242)	3079 (13658)	3849 (17074)	5774 (25613)	7698 (34148)	.02227 (631)		
8"	50.26 (324.26)	2010 (8940)	3015 (13411)	4020 (17881)	5026 (22356)	7539 (33533)	10052 (44711)	.02909 (829)		
10"	78.54 (506.74)	3141 (13974)	4712 (20961)	6283 (27948)	7854 (34935)	11781 (52402)	15700 (69834)	.04545 (1282)		
12"	113.10 (729.72)	4524 (20123)	6786 (30184)	9048 (40246)	11310 (50307)	16965 (75460)	22620 (100614)	.06545 (1852)		

Deduct these Forces for Retract Strokes

Rod	Rod Area	Pressure PSIG (bar)								Volume Cu ft³ (cm³) Displacement Per Inch
		40 (3)	60 (4)	80 (6)	100 (7)	150 (10)	200 (14)			
5/8"	.307 (1.98)	12 (53)	18 (80)	25 (111)	31 (138)	46 (205)	61 (271)	.00018 (5)		
1"	.785 (5.06)	31 (138)	47 (209)	63 (280)	78 (351)	118 (525)	157 (698)	.00045 (13)		
1-3/8"	1.485 (9.58)	59 (262)	89 (396)	119 (529)	149 (663)	222 (997)	297 (1321)	.00086 (24)		
1-3/4"	2.404 (15.51)	96 (423)	144 (641)	192 (854)	240 (1068)	360 (1601)	480 (2135)	.00139 (39)		
2"	3.142 (20.16)	126 (559)	189 (839)	251 (1118)	314 (1398)	471 (2096)	628 (2795)	.00182 (52)		
2-1/2"	4.909 (31.67)	196 (873)	295 (1310)	393 (1747)	491 (2184)	736 (3275)	981 (4367)	.00284 (80)		

- Precision operation maintains accurate positioning
- Large clamping surface ensures consistent performance
- Spring-engaged units engage in power-off situations
- Sealed to withstand harsh environments

Technical features

Bore sizes

NFPA cylinders: 1-1/2" to 6"
(see chart at right for bore/rod combinations)

Rod lock release pressure: 60 to 120 psi (4 to 8 bar)

Caution: Rodlock will not hold a load when mounted to cylinders with operating pressures in excess of 100 psi (7 bar). Refer to holding force for rod lock chart.

Temperature range: 33°F to 150°F (0.5°C to 66°C)

Rod lock mounting: Any position

Holding: Operates in both directions

Notes

If personal safety is required, an unrelated, redundant safety system should be used. Rod locks require clean, dry, pressure regulated air, lubrication is not required.

The rod must be kept clean and dry to maintain optimum holding forces. Rod rotation is not allowed when rod lock is engaged (not intended for torsional braking).

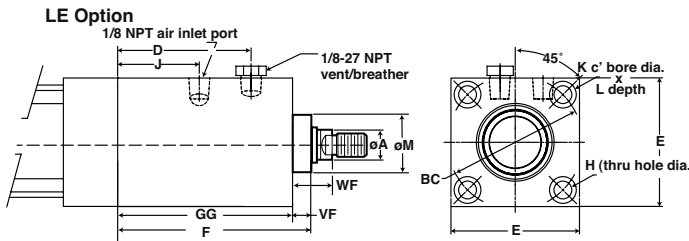

Holding force for rod lock

Rod Diameter	Bore Size	Holding* Force
0.625 in	1.500 in	180 lbs
0.625 in	2.000 in	314 lbs
0.625 in	2.500 in	491 lbs
1.000 in	3.250 in	830 lbs
1.000 in	4.000 in	1257 lbs
1.000 in	5.000 in	1960 lbs
1.375 in	6.000 in	2825 lbs

* Oversize rod diameters available upon request.

*CAUTION: Rated holding force corresponds to static load conditions. If the rated value is exceeded, slipping may occur.

LE Option

Bore Dia.	øA	øBC	E	EE	D	GG	F	VF	J	øH	K	L -.001/- .003	øM	WF
1.50	0.625	2.022	2.00	1/8 NPT	1.95	2.397	2.77	0.375	0.91	0.281	0.438	0.909	1.125	1.00
2.00	0.625	2.602	2.50	1/8 NPT	2.08	2.422	2.80	0.375	1.02	0.344	0.516	1.03	1.125	1.00
2.50	0.625	3.097	3.00	1/8 NPT	2.13	2.540	2.91	0.375	1.02	0.344	0.516	1.03	1.125	1.00
3.25	1.000	3.903	3.75	1/4 NPT	2.99	3.976	4.48	0.500	1.56	0.406	0.719	1.28	1.500	1.375
4.00	1.000	4.695	4.50	1/4 NPT	2.99	3.976	4.48	0.500	1.56	0.406	0.719	1.28	1.500	1.375
5.00	1.000	5.798	5.50	1/4 NPT	3.34	4.443	4.69	0.500	1.56	0.531	0.844	1.50	1.500	1.375
6.00	1.375	6.901	6.50	1/4 NPT	4.43	5.306	5.36	0.625	1.68	0.531	0.844	1.50	2.000	1.625

Dimensions in inches

System shown: Cylinder control using a 5/3 valve with the center open on the central port

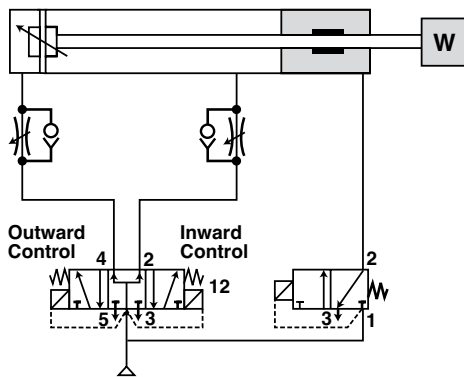

System shown: vertical mounting with the load beneath the cylinder

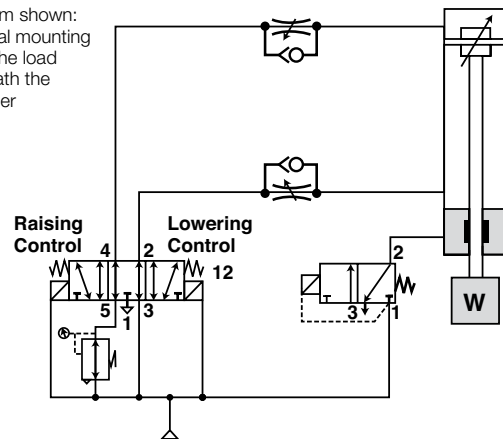

Cylinder Mounting Diagram Chart

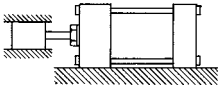
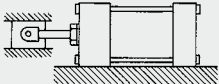
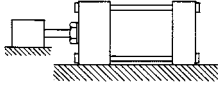
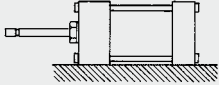
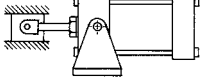
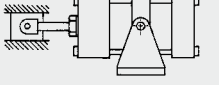
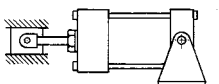
Cylinder Mounting	Rod End Connection	Mounting Style	Stroke Factor
Side Tapped, Head or Cap Flange, Tie Rod, Center or Side Lug	Fixed and Rigidly Guided		.50
Side Tapped, Head or Cap Flange, Tie Rod, Center or Side Lug	Pivoted and Rigidly Guided		.70
Side Tapped, Head or Cap Flange, Tie Rod, Center or Side Lug	Supported but not Rigidly Guided		2.00
Side Tapped, Head or Cap Flange, Tie Rod, Center or Side Lug	None		5.00
Head Trunnion	Pivoted and Rigidly Guided		1.00
Center Trunnion	Pivoted and Rigidly Guided		1.50
Cap Trunnion or Clevis	Pivoted and Rigidly Guided		2.00

Tie Rod Supports:

For long strokes, tie rod supports are provided. These supports are of the same envelope dimensions as the cylinder end caps.

NOTE: See chart for number of tie rod supports required.

Number of Tie Rod Supports Required

Cylinder Bore	Cylinder Stroke (in)				
	60	75	95	115	135
1-1/2"	1	1	2	2	3
2"	-	1	1	2	2
2-1/2"	-	-	1	1	1
3-1/4"	-	-	-	1	1
4"	-	-	-	-	1
5" and over	-	-	-	-	-

Tie Rod Tightening:

In order to reduce the possibility of cylinder binding or damage, tighten to quarter unit increments of the final torque value in the following order: #1, #2, #3, #4.

Then torque fully to the recommended foot pounds in the same order.

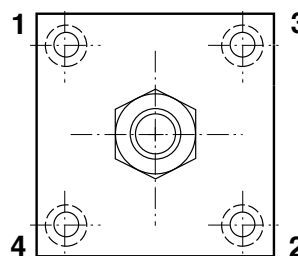

Recommended Torques for Tightening Tie Rods

Cylinder Bore	Standard Steel Tie Rods	Stainless Steel Tie Rods
1-1/2"	6.6 ft. lbs.	3.75 ft. lbs.
2"	11 ft. lbs.	7.5 ft. lbs.
2-1/2"	13 ft. lbs.	7.5 ft. lbs.
3-1/4"	20 ft. lbs.	13-14 ft. lbs.
4"	24 ft. lbs.	13-14 ft. lbs.
5"	40 ft. lbs.	33 ft. lbs.
6"	48 ft. lbs.	33 ft. lbs.
7" & 8"	100 ft. lbs.	65 ft. lbs.
10"	150 ft. lbs.	75 ft. lbs.
12"	175 ft. lbs.	87.5 ft. lbs.

Piston Rod Diameter Selection

Applications requiring long extend (push) strokes may require oversize piston rod diameters to prevent buckling.

To determine the correct rod diameter for your application follow these simple steps:

1. Select the force from the Cylinder Force and Volume Chart that is required for your application. For pressures not shown use:
Force = Piston Surface Area x Operating Pressure
2. From the Cylinder Mounting Diagram Chart (previous page) determine the Stroke Factor based on mounting style being used.
3. To obtain effective length "L", multiply cylinder stroke by appropriate Stroke Factor as determined in step 2. If cylinder has extra rod extension add this to the stroke length before obtaining effective length. **Effective Length = Actual Stroke x Stroke Factor**

4. To determine adequate rod diameter locate calculated effective length "L" on Rod Selection chart (below).
5. Selecting Stop Tubes: Stop tubes enhance the transverse load carrying capability of a long stroke cylinder by increasing the distance between the piston and rod bearing at full extension. When the value of L (calculated from the Adequate Rod Diameter Chart) is less than 40", a stop tube is **not** required. However, if L is 40" or more, 1" of stop tube is recommended for every 10" (or fraction thereof) over 40".

Stop Tube

Enhances the transverse load carrying capability of a long stroke cylinder by increasing the distance between the piston and rod bearing at full extension when placed on head end. Ideal for those applications requiring longer strokes or where additional rod stability is desired.

TO ORDER: Enter option code ST(-). Specify stop tube length.

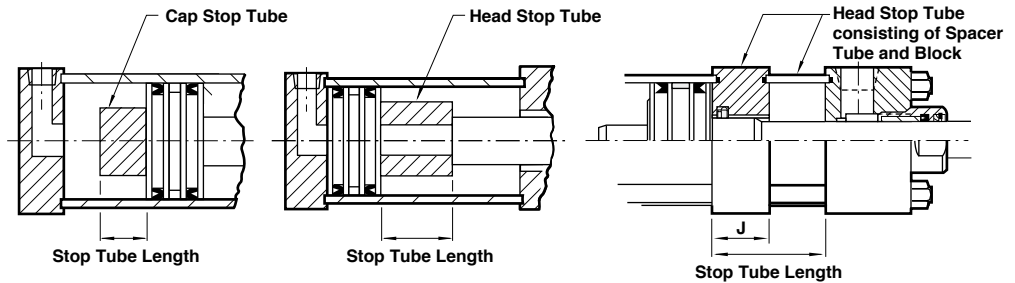

Rod Selection Chart

Extended Force (lbs)	Maximum effective length "L" recommended for rod diameters					
	5/8"	1"	1-3/8"	1-3/4"	2"	2-1/2"
50	95	-	-	-	-	-
100	65	170	-	-	-	-
150	50	135	260	-	-	-
200	43	115	220	-	-	-
300	34	93	180	300	-	-
500	25	70	135	250	-	-
750	20	56	110	185	250	-
1000	17	48	94	160	220	-
1500	13	38	80	130	170	260
2000	11	33	64	110	140	225
3000	9	26	51	90	115	180
4000	7	22	44	75	100	155
5000	-	20	39	66	88	140
6000	-	18	35	60	79	125
8000	-	15	30	52	68	110
10000	-	12	26	46	60	95
12500	-	10	22	41	52	86
15000	-	-	19	37	48	79
20000	-	-	14	29	41	68

Note: In some cases it may be necessary to use a larger bore cylinder than is required for force in order to obtain an adequate rod diameter.

Improved load carrying qualities
Ecology seal improves load dampening
Alignment coupler installed in tooling plate for self-alignment of cylinder rod to tooling plate connection prevents binding.

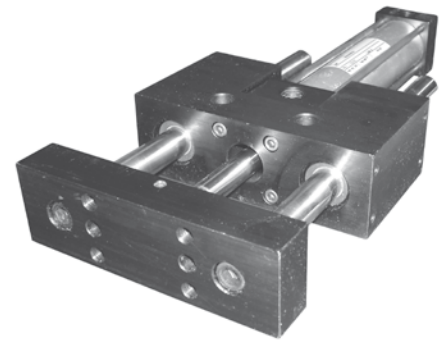

Technical features

NFPA tie rod cylinder
 Bore sizes: 1-1/2" and 2"
 Operating pressure: 250 psi max.
 Temperature range: -20°F to 200°F (-29°C to 107°C)
 Porting: 3/8 NPT
 Ecology piston seals available (fixed cushion, adjustable or extra long Decel-Air" cushions)
 Universal mounting (sleeve nut construction): Ease of cylinder removal (modular)

Linear thruster materials of construction

Body and tooling plate: Anodised aluminum alloy.
 Guide rods: Hardened high carbon bearing quality steel.
 Bushings: Composite (PTFE lined) self-lubricating or linear roller bearing.
 Felt washers: oil impregnated
 Retaining rings: to ensure bearing location.
 Alignment coupler: carbon steel

Cylinder materials of construction

Piston rod: Chrome plated high strength carbon steel
 Tie rods: High strength carbon steel
 Seals: Nitrile piston, piston rod and tube seals, Urethane piston rod wiper.
 Wearband: PTFE and graphite composite

Cylinder tube: Aluminum with hardcoat anodize
 Rod bearing: Oil impregnated sintered iron
 Endcaps: A and EA Series cylinder - aluminum
 J and EJ Series cylinder - steel

Decel-Air Cushions

Norgren's Decel cushioned cylinder was designed for applications where high velocity, low mass, material function or machine function is required, and where the kinetic energy to be absorbed during cushioning exceeds the parameters of standard cylinders equipped with Ecology piston seals and fixed or adjustable cushions. Decel cushions employ longer-than-standard air cushions to assist our Impact Dampening Piston Seal.

Energy Absorption Capacity of the Impact Dampening Seals

*Usable Pounds Stoppable at the Following Piston Speeds

This chart features the energy absorption capacity of the impact dampening piston seals with Non-Adjustable cushions.

Velocity In./Sec	1-1/2" Bore				2.0" Bore			
	Load (LBS.) Short Body Standard Guide Shaft	Load (LBS.) Short Body Oversize Guide Shaft	Load (LBS.) Long Body Standard Guide Shaft	Load (LBS.) Long Body Oversize Guide Shaft	Load (LBS.) Short Body Standard Guide Shaft	Load (LBS.) Short Body Oversize Guide Shaft	Load (LBS.) Long Body Standard Guide Shaft	Load (LBS.) Long Body Oversize Guide Shaft
6	151.3	149.1	150.8	148.2	267.0	261.9	265.7	259.4
12	34.1	31.9	33.6	31.0	59.6	54.5	58.3	52.0
18	12.4	10.2	11.9	9.3	7.8	16.1	20.0	13.6
24	4.9	2.7	4.44	1.8	7.8	2.7	6.5	0.2
30	1.3	0	0	0	1.5	0	0.2	0.0

*The weight of the cylinder piston has been deducted from the figures shown above.
 Note: The use of FPM Seals limits the absorption of the impact dampening seals by 50%.
 NOTE: The weight of a tooling plate, guide rods, and 1 extend and 1 retract stop collar has been added. (Guide rod weight is based on a 6.0" stroke cylinder.)

Dimensional data

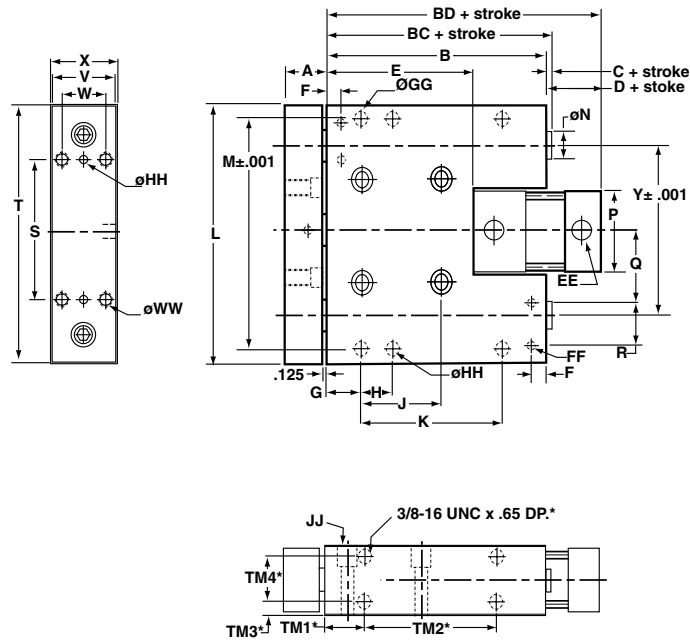

*Dimensions apply to
TM option only

Dimension	Size 3 (1-1/2" Bore)		Size 4 (2" Bore)	
	Long body	Short body	Long body	Short body
A	1.200	1.200	1.450	1.450
AA	2.375	NA	3.125	NA
B	5.765	3.650	8.000	5.000
BD	7.375	5.150	8.385	5.385
C	0.160	0.160	0.175	0.175
BC	5.925	3.810	8.175	5.175
D	1.450	1.340	0.385	0.385
E	3.750	1.500	4.760	1.760
EE	3/8 NPT	3/8 NPT	3/8 NPT	3/8 NPT
F	0.291	0.291	0.447	0.447
FF	1/4-20 x .40	1/4-20 x .40	1/4-20 x .50	1/4-20 x .50
G	0.875	0.875	1.000	1.000
GG	3/8-16 x .75DP	3/8-16 x .75DP	3/8-16 x .75DP	3/8-16 x .75DP
H	0.875	0.875	1.500	1.500
HH	.3764 x .47DP	.3764 x .47DP	.3764 x .50DP	.3764 x .50DP
J	2.375	2.375	3.125	3.125
JJ	.41 thru .59 C/B x .66DP		.53 thru .81 C/B x .66DP	
K	4.000	1.750	6.000	3.000
L	6.450	6.450	8.380	8.380
M	5.875	5.875	7.750	7.750
N (Standard)	0.750	0.750	1.000	1.000
N (Oversize)	1.000	1.000	1.375	1.375
P	2.000	2.000	2.500	2.500
Q	1.775	1.775	2.265	2.265
R	1.063	1.063	1.375	1.375
S	2.375	2.375	3.125	3.125
T	6.550	6.550	8.500	8.500
TM1*	1.313	1.313	1.500	1.500
TM2*	3.125	0.875	5.000	2.000
TM3*	0.350	0.350	0.375	0.375
TM4*	1.500	1.500	2.000	2.000
V	2.000	2.000	2.500	2.500
W	1.300	1.300	1.625	1.625
WW	3/8-16	3/8-16	1/2-13	1/2-13
X	2.200	2.200	2.750	2.750
Y	4.250	4.250	5.750	5.750
Z	2.375	2.375	3.125	3.125
ZZ	0.875	0.875	1.000	1.000

LS product ordering information

1 - Product	LS	1	2 - Size	3	2	3 - Cylinder Type	A	3	3	4	5	6	7	8	9	- Stroke - Options	
LS Linear slide unit			3 1-1/2"			A aluminum (NFPA tie rod)						S standard					
2 - Size			4 2"			EA aluminum (NFPA tie rod Ecology Seal)						S standard					
3 - Cylinder Type			J steel (NFPA tie rod)			EJ steel (NFPA tie rod Ecology Seal)						S standard					
4 - Cushions - Extend Stroke			3 non-cushioned*			7 adjustable cushions**						S standard					
			5 fixed cushions			9 decel adjustable cushions**						S standard					
5 - Cushions - Retract Stroke			7 adjustable cushions**			9 decel adjustable cushions**						S standard					
			9 decel adjustable cushions**									S standard					

9 - Guide Rod Diameter	S standard
O oversize	
8 - Guide Rod Bearing Type	C composite
R Roller +, ++	
7 - Slide Body Length	S short
L long	
6 - Slide Body Width	S standard

Options

- AE = stroke adjustment (collar & bumper) - extend stroke
- AR = stroke adjustment (collar & bumper) - retract stroke
- CR = corrosion resistance (includes linear slide and cylinder)
- GL = guide rod lubrication (includes oiler cups installed)
- GM = guide rod lubrication modification for oiler cups
- L() = non-standard port location
- ME = shock absorber mounting block - extend stroke
- MR = shock absorber mounting block- retract stroke
- N() = non-standard adjustable cushion needle location
- P() = non-standard port size (down one size = 1/4 NPT, up one size = 1/2 NPT)
- PS = magnetic piston (cylinder)
- PX() = tooling plate extension
- TM = side tapped mounting
- WC = linear thruster assembly without cylinder
- WS = replacement cylinder without slide
- V = high temperature FPM seals

Maximum Stroke

size 3 (1-1/2" bore)	size 4 (2" bore)
short body 18" 22"	
long body 24" 28"	

* Non-cushioned cylinders will have U-cup seals as standard. Ecology seals are not available as non-cushioned.
 ** Standard cushion adjustment location is side 1 and adds 1" to the overall length of the cylinder per end with standard port sizes.
 + Roller bearings are not available with oversized guide rods.
 ++ Roller bearing not available with chloroprene (corrosion resistance) option.

Load and Deflection Graphs

1-1/2" bore, 3/4 inch guide rod, short body, composite bearing

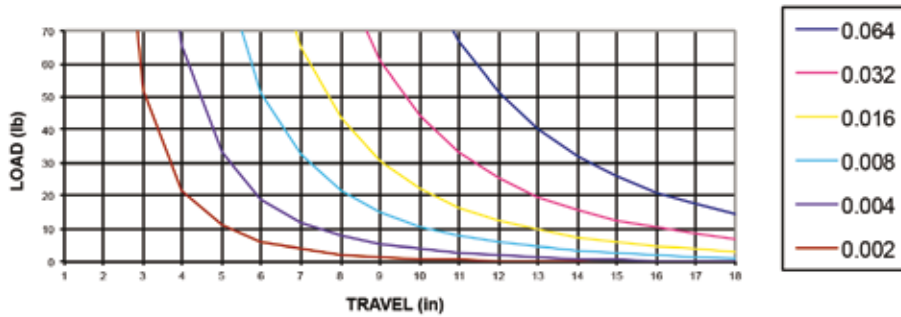

1-1/2" bore, 3/4 inch guide rod, short body, roller bearing

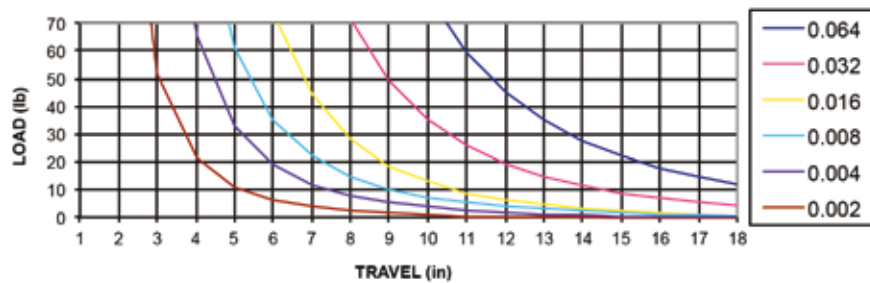

1-1/2" bore, 1 inch guide rod, short body, composite bearing

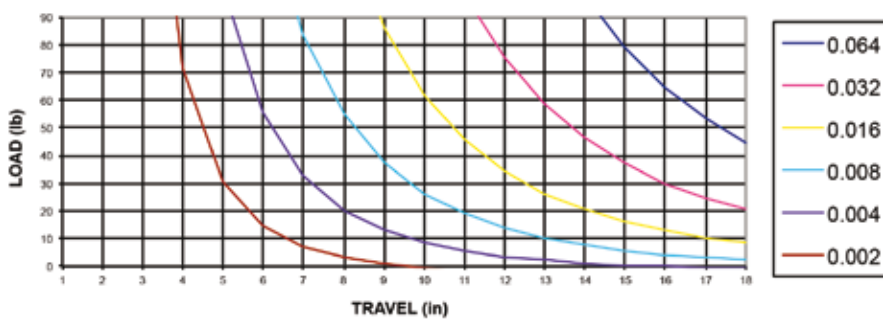

Load and Deflection Graphs

1-1/2" bore, 3/4 inch guide rod, long body, roller bearing

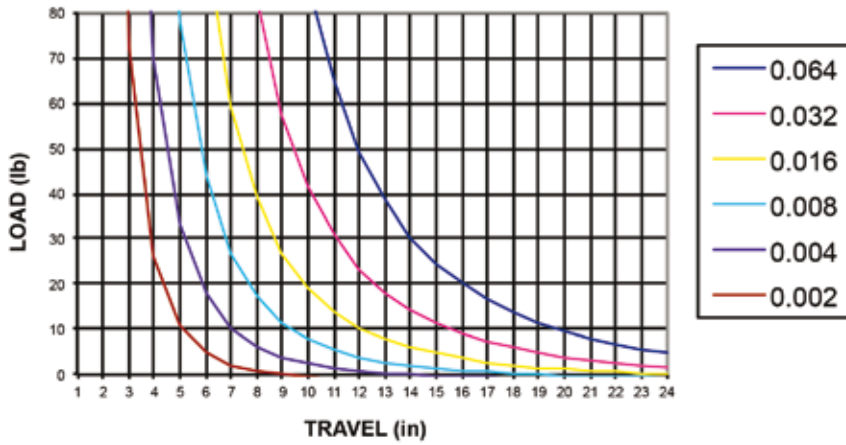

1-1/2" bore, 3/4 inch guide rod, long body, composite bearing

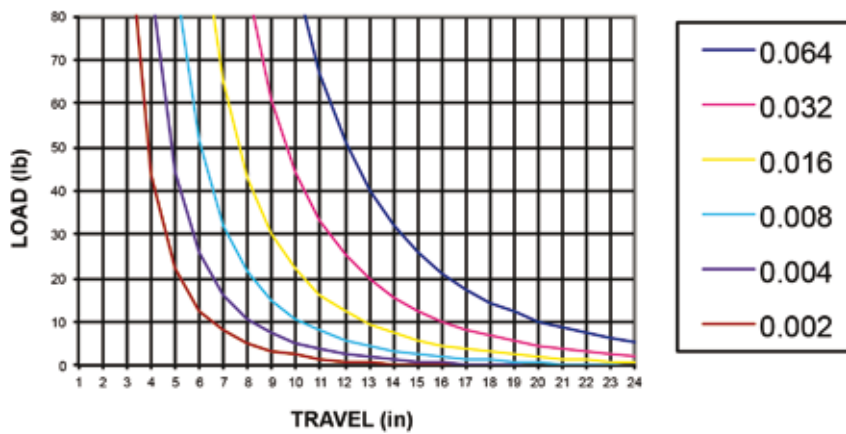

1-1/2" bore, 1 inch guide rod, long body, composite bearing

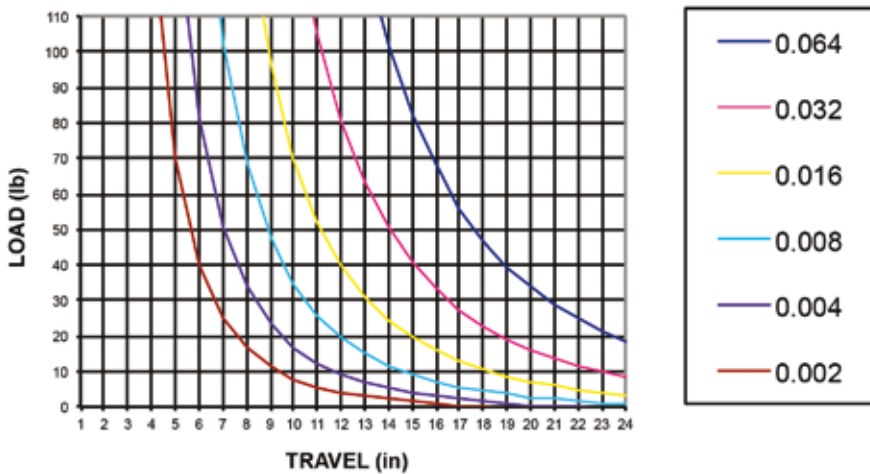

Load and Deflection Graphs

2.0" bore, 1 inch guide rod, long body, composite bearing

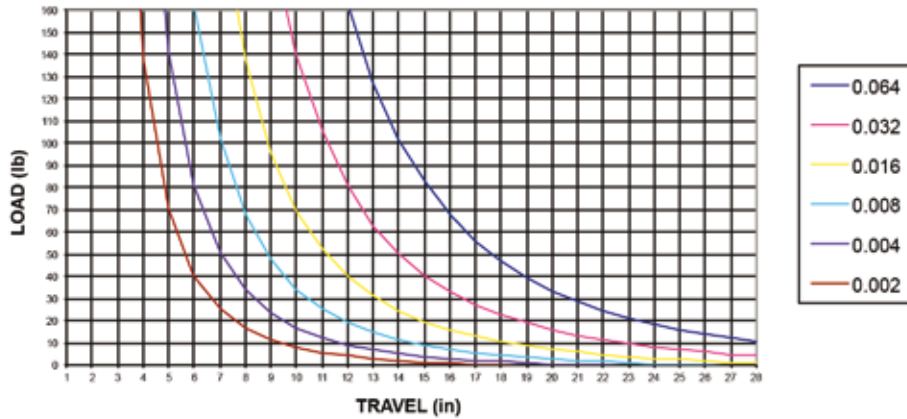

2.0" bore, 1 inch guide rod, long body, roller bearing

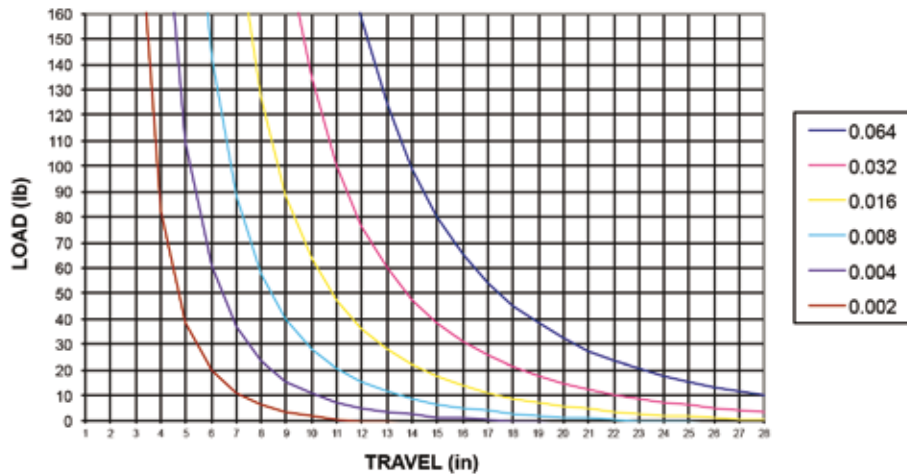

2.0" bore, 1-3/8 inch guide rod, long body, composite bearing

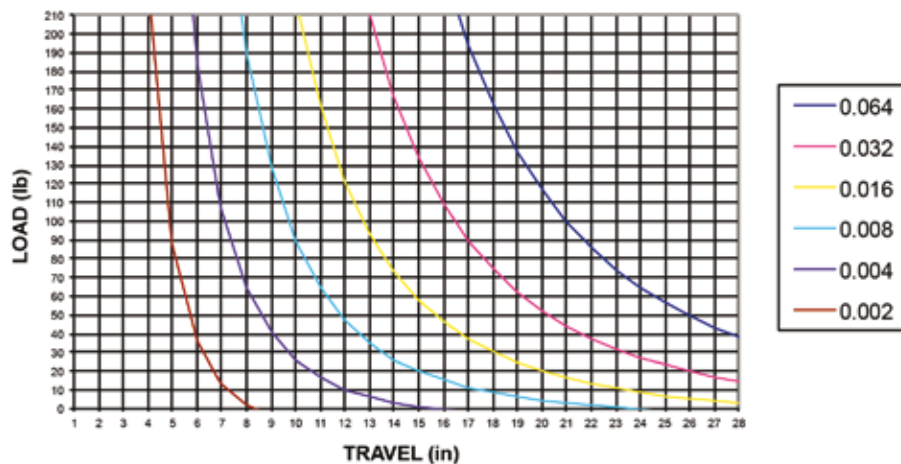

Load and Deflection Graphs

2.0" bore, 1 inch guide rod, short body, roller bearing

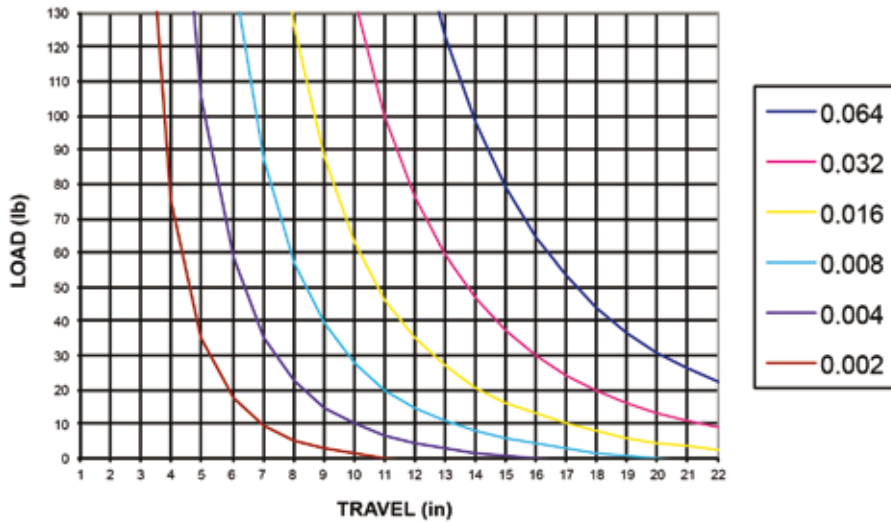

2.0" bore, 1 inch guide rod, short body, composite bearing

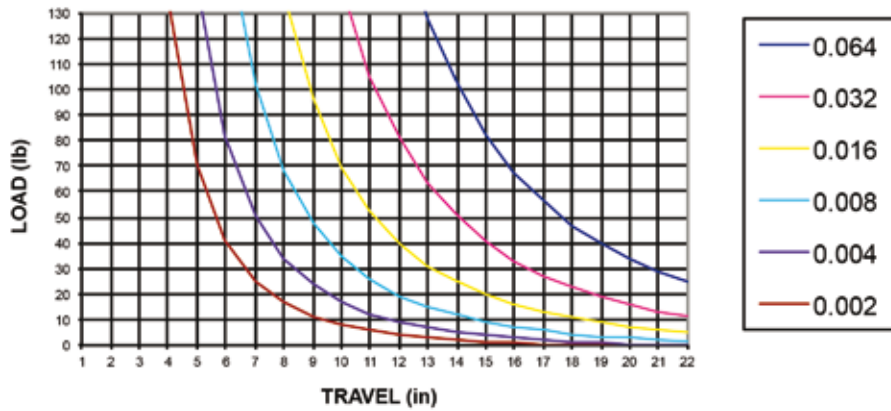

2.0" bore, 1-3/8 inch guide rod, short body, composite bearing

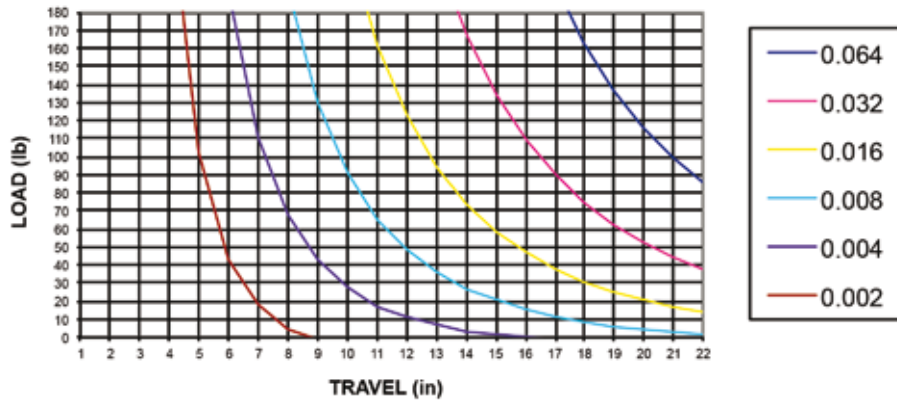

Competitively priced

Magnetic piston standard

Adjustable cushion standard

Sleeve nut construction standard



Technical features

Medium:

Filtered compressed air

Operating temperature:

-25°F to 140°F (-5°C to 60°C)
 With FPM Seals: -23°F to 300°F
 (-5°C to 150°C)

Operating Pressure:

Minimum 7 psi (.5 bar)
 Maximum 140 psi (9.7 bar)

Bore Sizes: 1-1/2", 2", 2-1/2",
 3-1/4", 4"

Rod Diameter: 5/8" diameter
 piston rod in 1-1/2", 2", 2-1/2"
 bore 1" diameter piston rod in
 3-1/4" and 4" bore

Lubrication: None required
 Norgren Air Cylinders are rated for
 "no lube added" service.

Materials

Head and End Caps: Die cast
 aluminum painted for corrosion
 protection.

Tube: Aluminum alloy, hard coat
 anodised

Piston: machined high-strength
 aluminum casting.

Rod Bearing: clean metal PTFE
 composite

Seals: nitrile rod seal/wiper, nitrile
 piston seals, nitrile tube end seals

Tie Rods: Nickel plated high-
 tensile strength steel.

1 Piston Rod: Hard chrome plated carbon steel, ground and polished.

2 Head Bearing Housing and cap: Die cast aluminum

3 Tie-Rods: Nickel plated steel

4 Piston: Machined aluminum.

5 Captive Cushion Needle Adjustment: Provides safe and precise cushion adjustment.

6 Wear Ring: PTFE material provides supreme wear and excellent bearing support.

7 Cylinder Tube: Hard anodised aluminum alloy, with corrosion and score resistant surface finish.

8 Piston Rod Wiper/Seal: Abrasion resistant nitrile.

9 Piston Seal: Single Nitrile bi-directional piston seal.

12 Cushion Seal: Nitrile cushion seal is captured within a precision machined groove allowing for linear and radial float eliminating misalignment.

11 Rod Bearing: A composite of PTFE and polyphenylene sulfide and bronze molded to a steel backing provides low friction and excellent linear features.

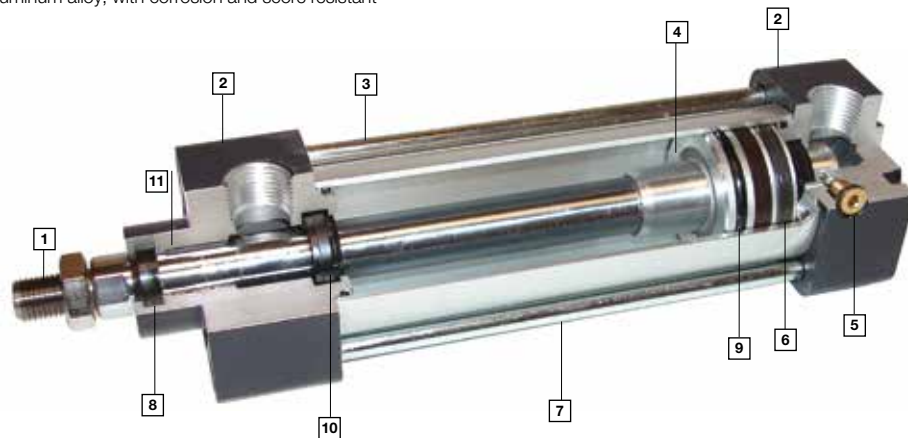

NEN "Add-a-mount" flexibility

NEN cylinders allow you to add NFPA mounts shown below when you order the cylinder from the factory, or add the mounts later.



NFPA MF1



NFPA MF2



NFPA MP1



NFPA MP2

Cylinder Order Information

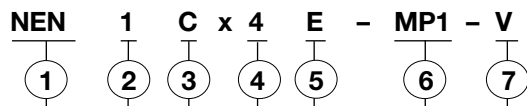

Series	
NEN	
Piston Rod Threads	
Small Male (Solid) (std)	1
Intermediate Thread Male (Solid)	2
Female	3
Bore	Single rod
1-1/2"	C
2.0"	D
2-1/2"	E
3-1/4"	F
4.0"	G
Stroke (whole inches)	
All bores max.*	48"

* Contact factory for strokes longer than 48".

Fraction of Stroke length	
0	Blank
0.125"	C
0.250	E
0.375	G
0.500	J
0.625	M
0.750	P
0.875	S

Additional Options	
FPM Seals	V
Rod Extension	RX
Non-standard piston rod thread	T
Piston Rod thread extension	TX
Stainless steel piston rod	SS
Mounting Options**	
MS4 (standard)	Blank
Head Rectangular Flange	MF1
Cap Rectangular Flange	MF2
Detachable Cap Clevis	MP2
Cap Fixed Clevis	MP1
Tie Rod Extended both ends	MX1
Tie Rod Extended Cap	MX2
Tie Rod Extended Head	MX3
Side Lug Mount	MS2

** For factory installed mounts specify mounting option in position 6. If no mount required leave position 6 blank. Mounting kits can be ordered separately. Contact factory for mounting kits, or visit www.norgren.com

NFPA (MS4) Side tap mount standard

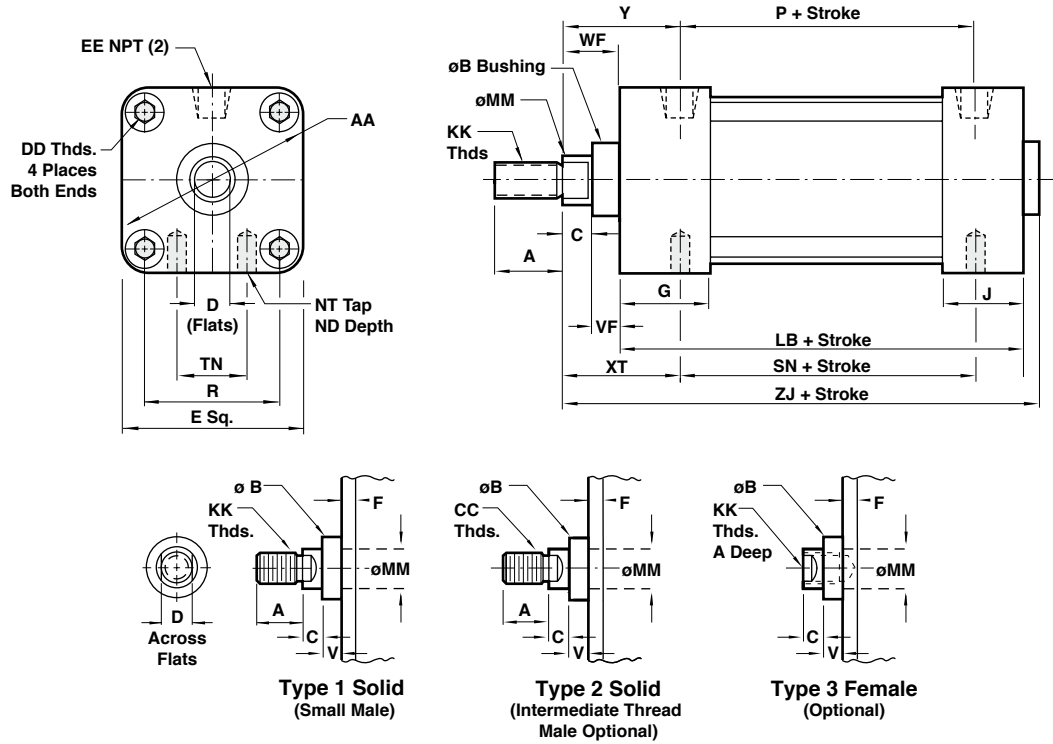

Bore	1-1/2"	2"	2-1/2"	3-1/4"	4"
ø Rod	5/8"	5/8"	5/8"	1"	1"
A	0.750	0.750 (19.05)	0.750 (19.05)	1.125 (28.58)	1.125 (28.58)
AA	2.020	2.600 (66.04)	3.100 (78.74)	3.900 (99.06)	4.700 (119.38)
B	1.124	1.124 (28.55)	1.124 (28.55)	1.500 (38.07)	1.499 (38.07)
BA	1.125 (28.58)	1.125 (28.58)	1.125 (28.58)	1.250 (28.58)	1.250 (28.58)
C	0.375 (9.53)	0.375 (9.53)	0.375 (9.53)	0.500 (12.70)	0.500 (12.70)
CC	1/2-20	1/2-20	1/2-20	7/8-14	7/8-14
D	0.562 (14.27)	0.562 (14.27)	0.562 (14.27)	0.875 (22.23)	0.875 (22.23)
DD	1/4-28	5/16-24	5/16-24	3/8-24	3/8-24
E	2.000 (50.80)	2.500 (63.50)	3.000 (76.20)	3.750 (95.25)	4.500 (114.30)
EE	3/8	3/8	3/8	1/2	1/2
G	1.260 (32.00)	1.260 (32.00)	1.300 (33.02)	1.570 (39.88)	1.570 (39.88)
J	1.010 (25.65)	1.060 (26.92)	1.060 (26.92)	1.180 (29.97)	1.180 (29.97)
KK	7/16-20	7/16-20	7/16-20	3/4-16	3/4-16
LB	3.625 (92.08)	3.625 (92.08)	3.750 (95.25)	4.250 (107.95)	4.250 (107.95)
MM	0.625 (15.88)	0.625 (15.88)	0.625 (15.88)	1.000 (25.40)	1.000 (25.40)
NT	1/4-20	5/16-18	3/8-16	1/2-13	1/2-13
ND	0.281 (7.14)	0.438 (11.13)	0.593 (15.06)	0.625 (15.88)	0.625 (15.88)
P	2.360 (59.94)	2.400 (60.96)	2.480 (62.99)	2.720 (69.09)	2.720 (69.09)
R	1.430 (36.32)	1.840 (46.74)	2.190 (55.63)	2.760 (70.10)	3.320 (84.33)
SN	2.250 (57.15)	2.250 (57.15)	2.375 (60.33)	2.625 (66.68)	2.625 (66.68)
TN	0.625 (15.88)	0.875 (22.23)	1.250 (31.75)	1.500 (38.10)	2.063 (52.40)
VF	0.625 (15.88)	0.625 (15.88)	0.625 (15.88)	0.875 (22.23)	0.875 (22.23)
WF	1.000 (25.40)	1.000 (25.40)	1.000 (25.40)	1.375 (34.93)	1.375 (34.93)
XT	1.938 (49.23)	1.938 (49.23)	1.938 (49.23)	2.438 (61.93)	2.438 (61.93)
Y	1.710 (43.43)	1.710 (43.43)	1.750 (44.45)	2.340 (59.44)	2.340 (59.44)
ZJ	4.750 (120.65)	4.750 (120.65)	4.870 (123.95)	5.820 (147.83)	5.820 (147.83)

All Dimensions in Inches

NFPA (MF1) Head Rectangular Flange Mount

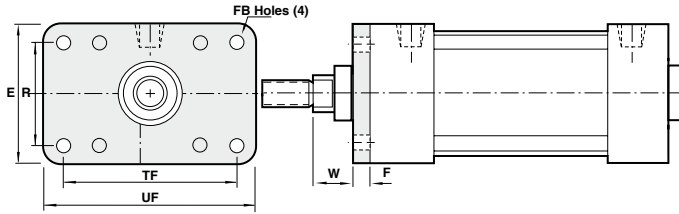

Bore	1-1/2"	2"	2-1/2"	3-1/4"	4"
E	2.000	2.500	3.000	3.750	4.500
F	.375	.375	.375	.625	.625
FB	.313	.375	.375	.438	.438
R	1.428	1.838	2.192	2.758	3.323
TF	2.750	3.375	3.875	4.688	5.438
UF	3.375	4.125	4.625	5.500	6.250
W	.625	.625	.625	.750	.750

NFPA (MF2) Cap Rectangular Flange Mount

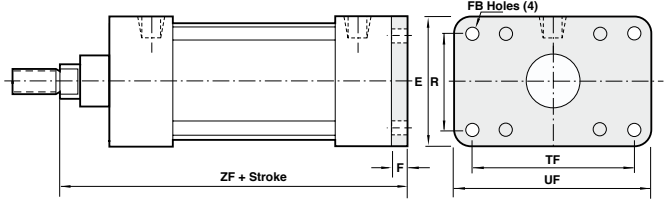

Bore	1-1/2"	2"	2-1/2"	3-1/4"	4"
E	2.000	2.500	3.000	3.750	4.500
F	.375	.375	.375	.625	.625
FB	.313	.375	.375	.438	.438
R	1.428	1.838	2.192	2.758	3.323
TF	2.750	3.375	3.875	4.687	5.438
UF	3.375	4.125	4.625	5.500	6.250
ZF	5.000	5.000	5.125	6.250	6.250

MP1 Mount

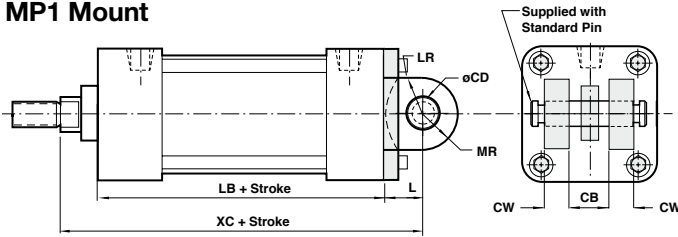

Bore	1-1/2"	2"	2-1/2"	3-1/4"	4"
CB	0.750	0.750	0.750	1.250	1.250
CD	0.500	0.500	0.500	0.750	0.750
CW	0.500	0.500	0.500	0.625	0.625
L	0.750	0.750	0.750	1.250	1.250
LB	3.625	3.625	3.750	4.250	4.250
LR	0.625	0.625	0.625	0.875	0.875
MR	0.625	0.625	0.625	0.875	0.875
XC	5.375	5.375	5.500	6.875	6.875

MP2 Mount

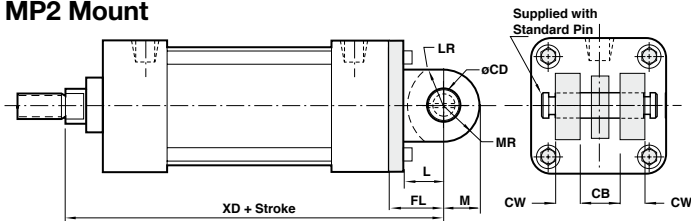

Bore	1-1/2"	2"	2-1/2"	3-1/4"	4"
CB	0.750	0.750	0.750	1.250	1.250
CD	0.500	0.500	0.500	0.750	0.750
CW	0.500	0.500	0.500	0.625	0.625
FL	1.125	1.125	1.125	1.875	1.875
L	0.750	0.750	0.750	1.250	1.250
LR	0.750	0.750	0.750	1.250	1.250
M	0.500	0.500	0.500	0.875	0.750
MR	0.625	0.625	0.625	0.875	0.875
XD	5.750	5.750	5.875	7.500	7.500

NFPA (MX1) (4) Extended Tie Rods Both Ends Mount
NFPA (MX2) Cap Tie Rods Extended Mount
NFPA (MX3) Head Tie Rods Extended Mount

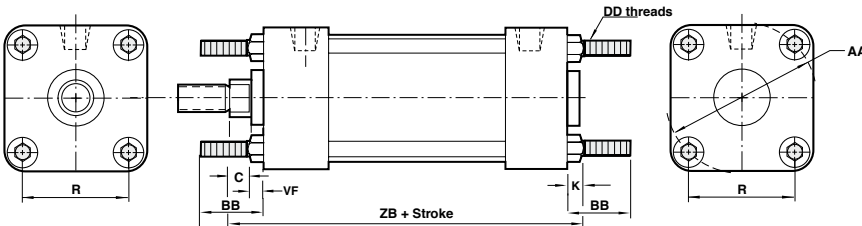

Bore	1-1/2"	2"	2-1/2"	3-1/4"	4"
AA	2.020	2.600	3.100	3.900	4.700
BB	1.000	1.125	1.125	1.375	1.375
C	0.375	0.375	0.375	0.500	0.500
DD	1/4 - 28	5/16 - 24	5/16 - 24	3/8 - 24	3/8 - 24
K	0.250	0.313	0.313	0.375	0.375
R	1.428	1.838	2.192	2.758	3.323
VF	0.625	0.625	0.625	0.875	0.875
ZB	4.875	4.938	5.063	6.000	6.000

All Dimensions in Inches

MS2 Mount

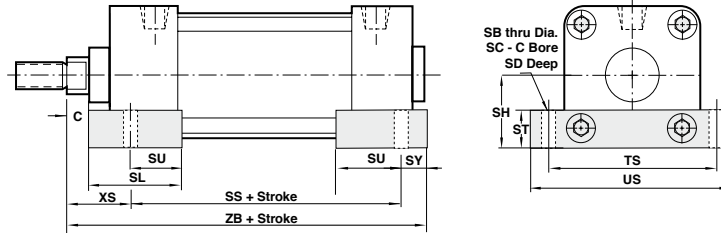

Bore	1-1/2"	2"	2-1/2"	3-1/4"	4"
SB	0.438	0.438	0.438	0.563	0.563
SC	0.690	0.690	0.690	0.800	0.800
SD	0.030	0.030	0.030	0.030	0.030
SH	1.000	1.250	1.500	1.875	2.250
SL	1.875	1.875	1.875	2.500	2.500
SY	0.940	0.940	0.940	1.250	1.250
SS	2.875	2.875	3.000	3.250	3.250
ST	0.620	0.620	0.750	1.000	1.000
SU	0.940	0.940	0.940	1.250	1.250
TS	2.750	3.250	3.750	4.750	5.500
US	3.500	4.000	4.500	5.750	6.500
XS	1.375	1.375	1.375	1.875	1.875
ZB	5.190	5.190	5.310	6.380	6.380

NEN Cylinder Accessories and Kits

RC (rod clevis)

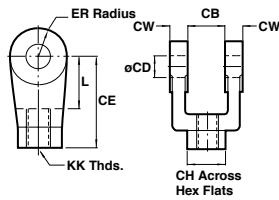

Kit number	KK	CB	CD	CE	CH	CW	ER	L
NENC-RC	7/16-20	0.750	0.500	1.500	1.000	0.500	0.500	0.750
NENF-RC	3/4-16	1.250	0.750	2.375	1.250	0.625	0.750	1.250

RC and RE rod accessories come complete with pivot pin and retaining clips.

RE (rod eye)

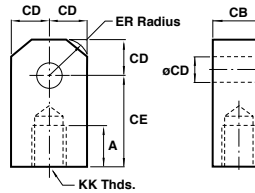

Kit number	KK	A	CB	CD	CE	ER
NENC-RE	7/16-20	0.750	0.750	0.500	1.500	0.563
NENF-RE	3/4-16	1.125	1.250	0.750	2.063	0.875

MS2 Mounting Kit

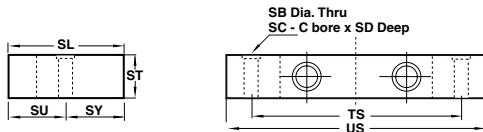

Kit number	SB	SC	SD	SY	ST	SU	TS	US
MK-NENC-MS2	0.41	0.69	0.03	0.94	0.62	0.94	2.75	3.50
MK-NEND-MS2	0.41	0.69	0.03	0.94	0.62	0.94	3.25	4.00
MK-NENE-MS2	0.41	0.69	0.03	0.94	0.75	0.94	3.75	4.50
MK-NENF-MS2	0.52	0.80	0.03	1.25	1.00	1.25	4.75	5.75
MK-NENG-MS2	0.52	0.80	0.03	1.25	1.00	1.25	5.50	6.50

NFPA MF1 / MF2 Mounting Kit - MK-NEN-MF1

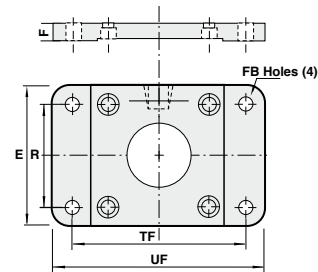

Kit number	UF	TF	FB	E	R	F
MK-NENC-MF1	3-3/8	2-3/4	5/16	2.00	1.43	3/8
MK-NEND-MF1	4-1/8	3-3/8	3/8	2-1/2	1.84	3/8
MK-NENE-MF1	4-5/8	3-7/8	3/8	3.00	2.19	3/8
MK-NENF-MF1	5-1/2	4-11/16	7/16	3-3/4	2.76	5/8
MK-NENG-MF1	6-1/4	5-7/16	7/16	4-1/2	3.32	5/8

All Dimensions in Inches

EB (eye bracket)

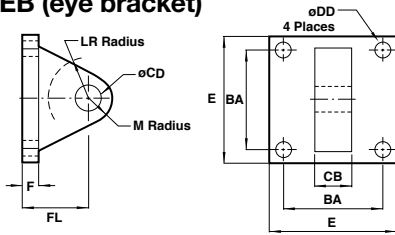

NFPA Eye Bracket	NENC-EB	NENF-EB
BA	1.625	2.563
CB	0.750	1.250
CD	0.500	0.750
DD	0.406	0.531
E	2.500	3.500
F	0.375	0.625
FL	1.125	1.875
LR	0.750	1.250
M	0.500	0.750

All dimensions ± .015 unless otherwise noted.

MP1 Mount kit - MK-NEN-MP1

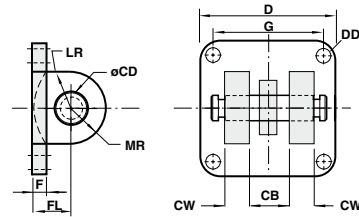

Kit number	CD	FL	F	B	CW	D	MR	G	LR	DD
MK-NENC-MP1	0.502	0.75	0.38	0.76	0.50	2.00	0.62	1.43	0.62	0.28
MK-NEND-MP1	0.502	0.75	0.38	0.76	0.50	2.50	0.62	1.84	0.62	0.34
MK-NENE-MP1	0.502	0.75	0.38	0.76	0.50	3.00	0.62	2.19	0.62	0.34
MK-NENF-MP1	0.752	1.25	0.63	1.26	0.62	3.75	0.87	2.77	0.87	0.41
MK-NENG-MP1	0.752	1.25	0.63	1.26	0.62	4.50	0.87	3.32	0.87	0.41

MP1 and MP2 kits come complete with mounting hardware, pivot pin and retaining clips.

MX1 Mount kit

Kit includes 8 threaded studs and hex nuts.

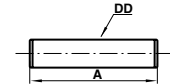

Kit number	DD	A
MK-NENC-MX1	1/4-28	1.500
MK-NEND-MX1	5/16-24	1.500
MK-NENE-MX1	5/16-24	1.500
MK-NENF-MX1	3/8-24	2.000
MK-NENG-MX1	3/8-24	2.000

MP2 Mount kit - MK - NEN - MP2

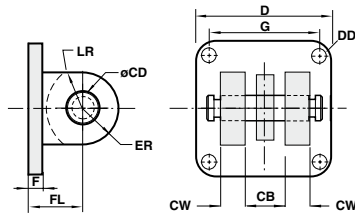

Kit number	CD	FL	F	B	CW	D	ER	G	DD
MK-NENC-MP2	0.502	1.13	0.38	0.76	0.50	2.00	0.62	1.43	0.28
MK-NEND-MP2	0.502	1.13	0.38	0.76	0.50	2.50	0.62	1.84	0.34
MK-NENE-MP2	0.502	1.13	0.38	0.76	0.50	3.00	0.62	2.19	0.34
MK-NENF-MP2	0.752	1.88	0.63	1.26	0.62	3.75	0.87	2.77	0.41
MK-NENG-MP2	0.752	1.88	0.63	1.26	0.62	4.50	0.87	3.32	0.41

P (pin)

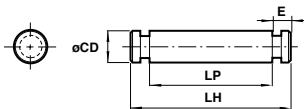

NFPA Pin	NEN-5	NEN-7
CD	0.500	0.750
E	0.109	0.125
LH	2.094	2.875
LP	1.875	2.625

All Dimensions in Inches