

Part No.	Type	Nominal diameter	Withdraw. force	Rated current	Contact resistance
----------	------	------------------	-----------------	---------------	--------------------

24.0231 SPP 4

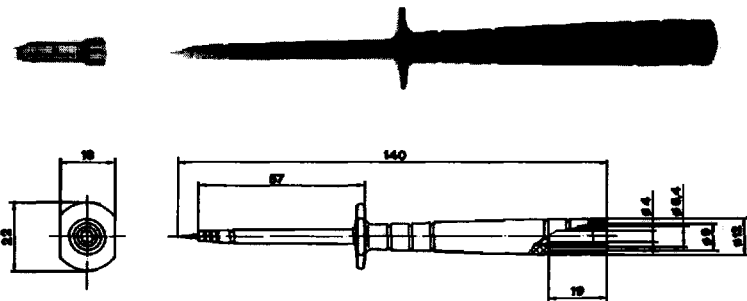

4 mm - - -



1:2.5

Test probe with steel needle and 4 mm (.160 in) dia. in-line safety socket, polyamide insulated.  
Test probe includes transparent protective cap  
SchK-SPP 4, ..... # 24.5075

Ratings:  
 • Rated voltage: ..... 1000 V, CAT III  
 • Insulation coordination: ..... 8000 V/3 (applies only to handle between collar and socket)  
 • Test voltage: ..... 4350 V  
 • Operating temperature: ..... -40°C to 80°C (-40°F to 176°F)

Colors: 21, 22

24.0235 SPP 4-S



4 mm - - -

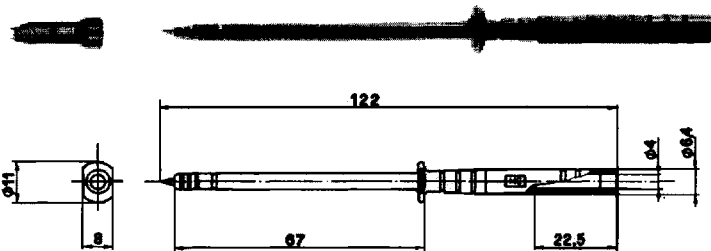

1:2

Test probe with steel needle and 4 mm (.160 in) dia. in-line socket for spring-loaded 4 mm (.160 in) dia. plugs. Polyamide insulated.  
Test probe includes transparent protective cap  
SchK-SPP 4, ..... # 24.5075

Ratings:  
 • Rated voltage: ..... 1000 V, CAT III  
 • Insulation coordination: ..... 8000 V/3 (applies only to handle between collar and socket)  
 • Test voltage: ..... 3250 V  
 • Operating temperature: ..... -40°C to +80°C (-40°F to 176°F)

Colors: 21, 22

24.0238 SPP 4-S/F



4 mm - - -

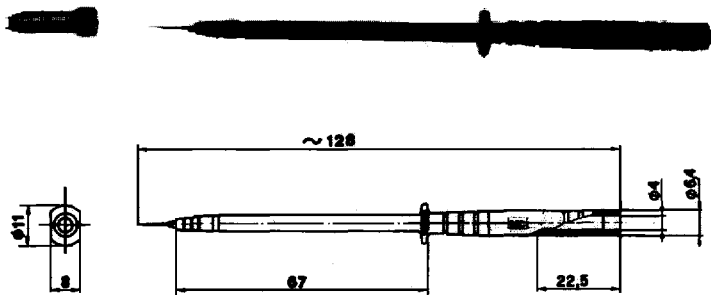

1:2

Test probe with spring-loaded steel needle and in-line safety socket 4 mm (.160 in) dia. accepts safety plugs, patch cords or any spring-loaded plugs. Polyamide insulated.  
Test probe includes transparent protective cap  
SchK-SPP 4, ..... # 24.5075

Ratings:  
 Rated voltage: ..... 1000 V, CAT III  
 Insulation coordination: ..... 8000 V/3 (applies only to handle between collar and socket)  
 Test voltage: ..... 3250 V  
 Operating temperature: ..... -40°C to 80°C (-40°F to 176°F)

Colors: 21, 22

20 - green/yellow 21 - black 22 - red 23 - blue 24 - yellow 25 - green 26 - violet 27 - brown 28 - gray 29 - white 33 - transparent

Nominal diameter    Withdraw. force    Rated current    Contact resistance

Type

Part No

4 mm                    -                    -                    0.8 mΩ



SPP 4-L

24.0231

Test probe with 4 mm (.160 in) dia. plug, machined brass, nickel plated with nickel plated MC®-Multilam™ and 4 mm (.160 in) dia. in-line safety socket, polyamide insulated. Matching MC sockets, jacks and binding posts, accepting safety plugs/patch cords or any spring-loaded plugs.



Test probe includes transparent protective cap  
SchK-SPP 4, ..... # 24.5075

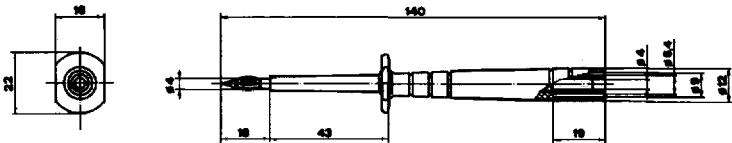

Ratings:

- Rated voltage: ..... 1000 V, CAT III
- Insulation coordination: ..... 8000 V/3 (applies only to handle between collar and socket)
- Test voltage: ..... 4350 V
- Operating temperature: ..... -40°C to 80°C (-40°F to 176°F)

Colors: 21 - 26

1:2.8

4 mm                    -                    -                    0.8 mΩ



SAPP 4-L

24.0234

Solder-on test probe and 4 mm (.160 in) dia. plug made of machined brass and nickel plated with spring-loaded MC®-Multilam™. Suitable for sockets 4 mm (.160 in). Polyamide insulated.



Solder connection suitable for wires up to 2.5 mm² (13 AWG).

Test probe includes transparent protective cap  
SchK-SPP 4, ..... # 24.5075

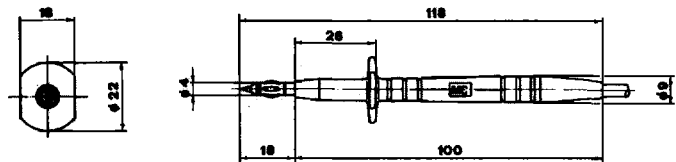

Ratings:

- Rated voltage: ..... 1000 V, CAT II
- Insulation coordination: ..... 8000 V/2 (applies only to handle portion between collar and wire)
- Test voltage: ..... 4350 V
- Operating temperature: ..... -40°C to +80°C (-40°F to 176°F)

Colors: 21, 22

1:2.5

SchK-SPP 4

24.5075

Transparent protective cap supplied with test probes SPP 4, SPP 4-S/2 and test lead SMK 425-L. Cap has integrated IC probe head for 2.54 mm (.100 in) matrix (DIL).

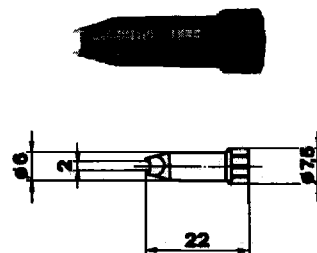

1:1

20 - green/yellow    21 - black    22 - red    23 - blue    24 - yellow    25 - green    26 - violet    27 - brown    28 - gray    29 - white    33 - transparent

Part No.	Type	Nominal diameter	Withdraw. force	Rated current	Contact resistance
----------	------	------------------	-----------------	---------------	--------------------

6.9640 XPP-80/2-16  
 XPP-80/2-19  
 XPP-80/4

4 mm - 10 A -

6.9644 XPP-80/2-19  
 XPP-80/4

6.9642 XPP-80/4

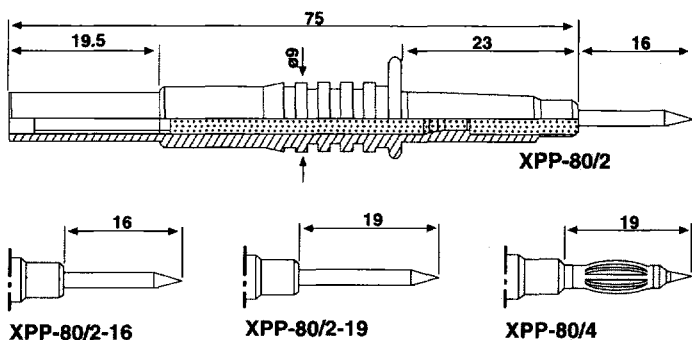

Safety plug-on test probe, rated 1000 V, CAT II, with a 4 mm safety socket for connection onto safety leads. The polyamide 6.6 insulating body incorporates an anti-roll finger guard which defines the limit of the handling area. The probe is available with a 2 mm refined steel tip (XPP-80/2) or a 4 mm Multilam™ plug tip (XPP-80/4).

Colors: 21 - 25



1:1

6.9643 XPP-80/U

4 mm - - -

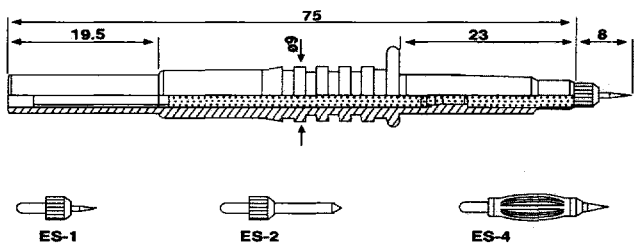

Safety plug-on test probe, rated 1000 V, CAT II, with a 4 mm safety socket on one end and a replaceable 1 mm stainless steel tip screwed into a M2 internal thread on the other. The polyamide 6.6 insulating body incorporates an anti-roll finger guard which defines the limit of the handling area.

Accessories:

- ES-1: 1mm stainless steel tip (1A) ..... # 66.9620
- ES-2: 2mm brass tip (10A) ..... # 66.9621
- ES-4: 4mm Multilam™ plug tip (20A) ..... # 66.9622
- ES-K: Kit with 1/2/4 tips ..... # 66.9619



1:1

Colors: 21 - 23

6.9112 PP-115/4  
 PP-115/2

4 mm - 10 A  
 20 A -

6.9115 PP-115/2

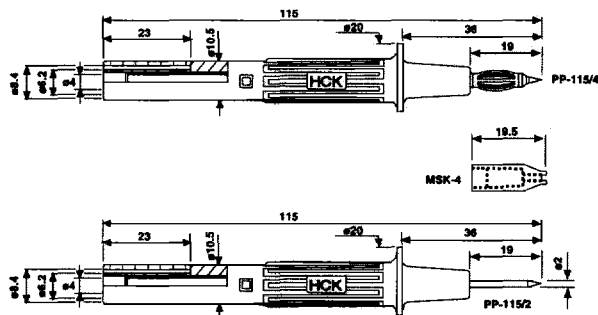

Safety plug-on probes, rated 1000 V, CAT III, is available with 2 mm rigid stainless steel tip (PP-115/2) rated at 10 A, or with 4 mm Multilam™ plug tip (PP-115/4) rated at 20 A. The polyamide 6.10 body houses a 4 mm safety socket for connection to test leads and features a molded finger guard which defines the limit of the safe handling area. PP-115/4 is supplied with a protective cap (MSK-4) for taking discrete readings from IC-pins.

Accessories:

- MSK-4: Protective cap ..... # 66.9108



2:1

Colors: 21

20 - green/yellow 21 - black 22 - red 23 - blue 24 - yellow 25 - green 26 - violet 27 - brown 28 - gray 29 - white 33 - transparent

Nominal diameter      Withdraw. force      Rated current      Contact resistance

Type

Part No

4 mm      -      5 A      -

HP-150/A  
HP-150/B

66.9113  
(HP-150/A)

Safety plug-on probes, rated 1000 V, CAT III, 5 A, has a refined steel tip for piercing insulation and lacquer and is available with the 4 mm safety socket flush with the rear of the grip (HP-150/B) or recessed 4 mm (HP-150/A). The HP-150/A is only suitable for use with in-line safety plugs. The probe features a molded finger guard which defines the limit of the safe handling area and is supplied with a protective cap (MSK-150) for taking discrete readings from IC-pins. The insulation material is TPE which has very good mechanical and dielectric properties.

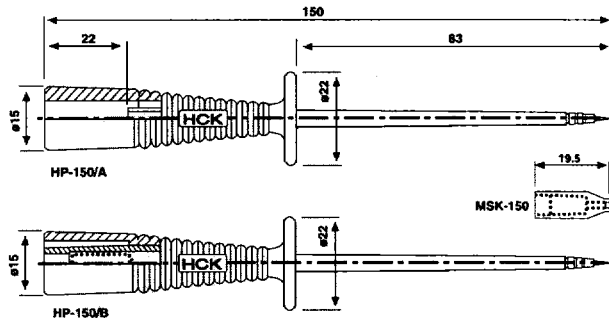

66.9114  
(HP-150/B)

Accessories:

- MSK-150: Protective cap ..... # 66.9107



Colors: 21 - 23

1:2

4 mm      -      1 A      -

MGA-4

64.9740

Mini plug-on test probe, rated 1 A with a 4 mm socket and a replacable 1 mm steel tip. This probe is especially suitable for standard test leads FML and SML on page 132.

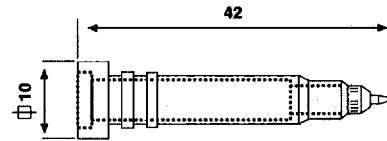

Colors: 21 - 26

1:1

4 mm      -      -      -

PP-130

64.9200

4 mm plug-on probe with high-grade steel tip which can pierce oxide layers and lacquer or plastic insulation. This probe features an anti-roll 16 mm square finger guard and insulation which can be cut back to bare a suitable length tip. A 4 mm brass nickel-plated socket is situated in the grip to accept standard test leads.

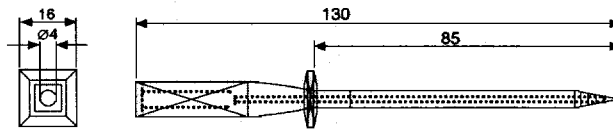

Colors: 21 - 26

1:2

4 mm      -      -      -

PP-140

64.9200

4 mm test probe, rated 250 V, CAT II, with a high-grade steel tip which can pierce oxide layers and lacquer or plastic insulation. This probe features a hexagonal anti-roll finger guard and insulation which can be cut back to bare a suitable length of tip. A recessed 4 mm brass nickel-plated socket is situated in the grip to accept standard test leads.

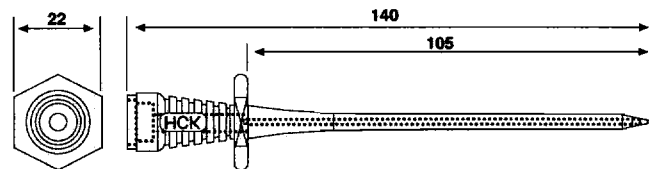

Colors: 21 - 23

1:2

20 - green/yellow    21 - black    22 - red    23 - blue    24 - yellow    25 - green    26 - violet    27 - brown    28 - gray    29 - white    33 - transparent

Part No.	Type	Nominal diameter	Withdraw. force	Rated current	Contact resistance
----------	------	------------------	-----------------	---------------	--------------------

19.0145-100  
100 cm)

SMK 425-AR



4 mm - 32 A 0.8 mΩ

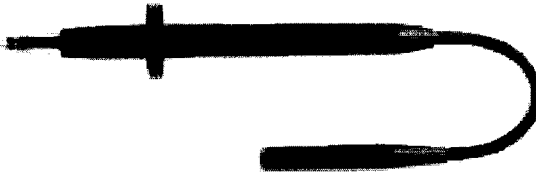

Test probe with 4 mm (.160 in) dia. safety plug. Needle of test probe spring-loaded with MC®-Multilam™ matching 4 mm (160 in) dia. sockets and jacks.

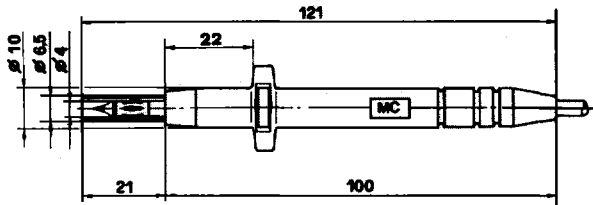

Ratings:

- Rated voltage: ..... 600 V, CAT III
- Insulation coordination: ..... 6000 V/2 (applies only to handle portion between collar and wire / safety plug).
- Test voltage: ..... 3250 V
- Operating temperature: ..... -10°C to +70°C (14°F to 158°F)

Retractable protecting sleeve at the needle.

Colors: 21, 22, 24, 25, 27

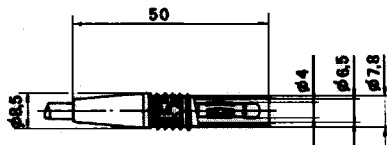

1:2

18.0111-100  
100 cm)

SMK 425-L

(SMK 425-L only)



4 mm - 32 A / 19 A 0.8 mΩ

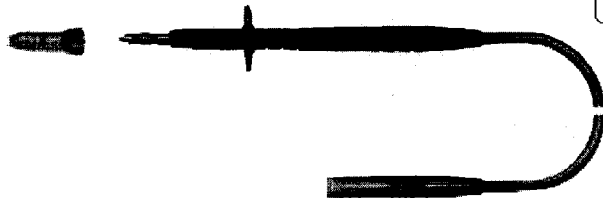

Test probe with 4 mm (.160 in) dia. safety plug. Needle of test probe spring-loaded with MC®-Multilam™ matching 4 mm (160 in) dia. sockets and jacks.

Components and ratings for SMK 425-L:

- Test probe SAPP 4-L ..... # 24.0234
- Multilam™ plug LS 425-SL ..... # 22.1025
- Insulator KT 425-SL ..... # 22.2260
- Wire Flexi-2V/HK 2.5-D ..... # 60.7033
- Rated voltage: ..... 1000 V
- Insulation coordination: ..... 6000 V/2
- Test voltage: ..... 3250 V
- Operating temperature: ..... -10°C to +70°C (14°F to 158°F)

Components and ratings for SMK 410-L:

- Test probe SAPP 4-L ..... # 24.0234
- Multilam™ plug LS 425-SL ..... # 22.1025
- Insulator KT 425-SL ..... # 22.2260
- Wire Flexi-2V/HK 1-D ..... # 60.7036
- Rated voltage: ..... 1000 V
- Insulation coordination: ..... 6000 V/2
- Test voltage: ..... 3250 V
- Operating temperature: ..... -10°C to +70°C (14°F to 158°F)

18.0108-100  
100 cm)

SMK 410-L

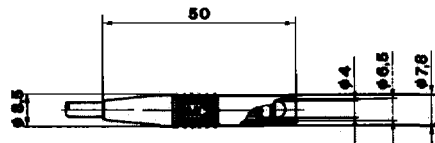
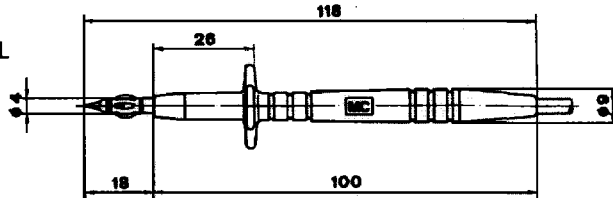

1:2

Colors: 21, 22

20 - green/yellow 21 - black 22 - red 23 - blue 24 - yellow 25 - green 26 - violet 27 - brown 28 - gray 29 - white 33 - transparent

Nominal diameter    Withdraw. force    Rated current    Contact resistance

Type    Part No

4 mm    -    15 A    0.8 mΩ

Safety probe lead, rated 1000 V, CAT II, 15 A assembled with a 4 mm safety probe on one end and a in-line safety plug on the other. The lead is highly flexible 0.75<sup>2</sup> cable in double insulated PVC insulation.

- Accessories: ..... see page 154
- Protective cap MSK-4 ..... 66.9108

Colors: 21 - 23

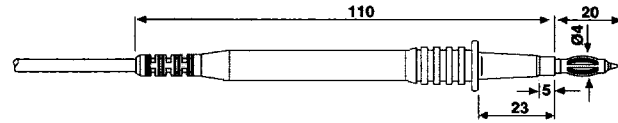
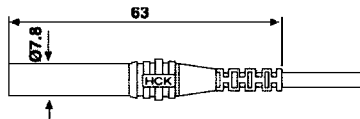

**XPF-402/4**    66.9616-10I (100 cm)  
66.9616-15I (150 cm)  
66.9616-20I (200 cm)  
66.9616-30I (300 cm)

1:2

4 mm    -    15 A    0.8 mΩ

Safety probe lead, rated 1000 V, CAT II, 15 A assembled with a 4 mm safety probe on one end and a in-line safety plug on the other. The lead is extremely flexible 0.75<sup>2</sup> cable in reinforced silicone insulation.

- Accessories: ..... see page 154
- Protective cap MSK-4 ..... 66.9108

Colors: 21 - 23

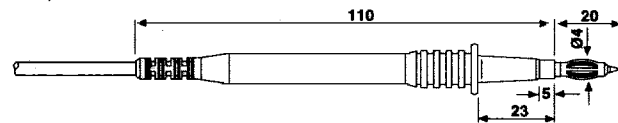
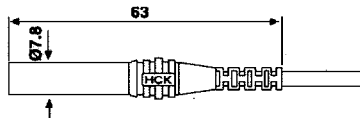

**XPS-402/4**    66.9617-10I (100 cm)  
66.9617-15I (150 cm)  
66.9617-20I (200 cm)  
66.9617-30I (300 cm)

1:2

4 mm    -    15 A    0.8 mΩ

Safety probe lead, rated 1000 V, CAT II, 15 A assembled with a 4 mm safety probe on one end and a right-angled safety plug on the other. The lead is highly flexible 0.75<sup>2</sup> cable in double insulated PVC insulation.

- Accessories: ..... see page 154
- Protective cap MSK-4 ..... 66.9108

Colors: 21 - 23

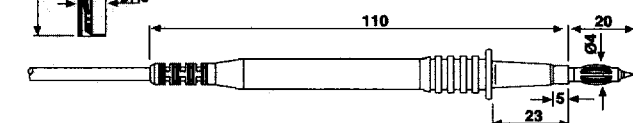
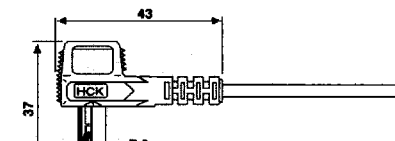

**XPF-482/4**    66.9627-10I (100 cm)  
66.9627-15I (150 cm)  
66.9627-20I (200 cm)  
66.9627-30I (300 cm)

1:2

4 mm    -    15 A    0.8 mΩ

Safety probe lead, rated 1000 V, CAT II, 15 A assembled with a 4 mm safety probe on one end and a right-angled safety plug on the other. The lead is extremely flexible 0.75<sup>2</sup> cable in reinforced silicone insulation.

- Accessories: ..... see page 154
- Protective cap MSK-4 ..... 66.9108

Colors: 21 - 23

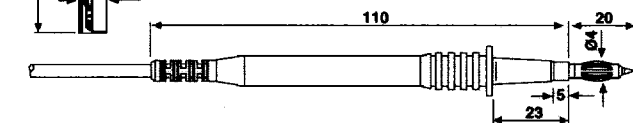
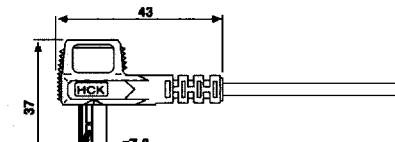

**XPS-482/4**    66.9628-10I (100 cm)  
66.9628-15I (150 cm)  
66.9628-20I (200 cm)  
66.9628-30I (300 cm)

1:2

20 - green/yellow    21 - black    22 - red    23 - blue    24 - yellow    25 - green    26 - violet    27 - brown    28 - gray    29 - white    33 - transparent

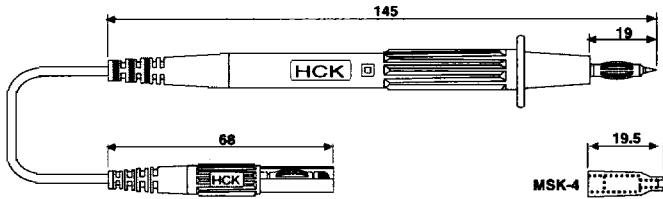
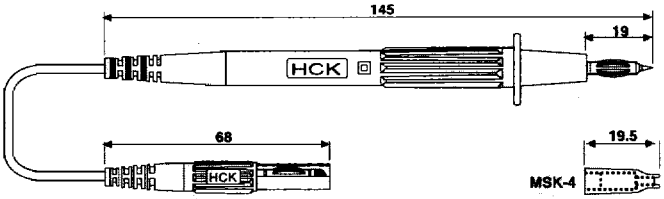
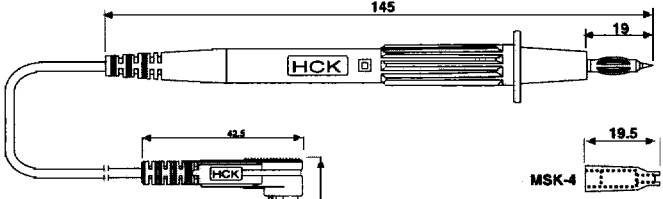
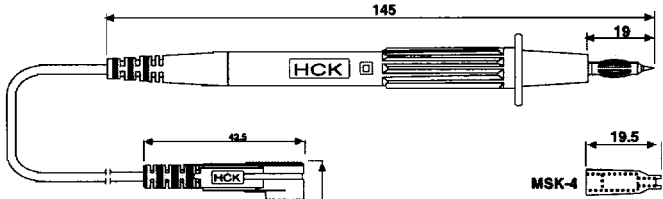
Part No.	Type	Nominal diameter	Withdraw. force	Rated current	Contact resistance
i6.9023-100 (100 cm)	<b>XPF-414</b> 	4 mm	-	19 A	0.8 mΩ
i6.9023-150 (150 cm)					
i6.9023-200 (200 cm)					
i6.9023-300 (300 cm)					
i6.9024-100 (100 cm)	<b>XPS-414</b> 	4 mm	-	19 A	0.8 mΩ
i6.9024-150 (150 cm)					
i6.9024-200 (200 cm)					
i6.9024-300 (300 cm)					
i6.9008-100 (100 cm)	<b>XPF-484</b> 	4 mm	-	19 A	0.8 mΩ
i6.9008-150 (150 cm)					
i6.9008-200 (200 cm)					
i6.9008-300 (300 cm)					
i6.9007-100 (100 cm)	<b>XPS-484</b> 	4 mm	-	19 A	0.8 mΩ
i6.9007-150 (150 cm)					
i6.9007-200 (200 cm)					
i6.9007-300 (300 cm)					

Safety probe lead, rated 1000 V, CAT III, 19 A, have on one end a safety probe with 4 mm Multilam™ plug tip and an in-line 4mm safety plug on the other. The lead is highly flexible 1.0 mm<sup>2</sup> cable in double insulated PVC insulation. The lead is supplied with a protective cap (MSK-4) for taking discrete reading from IC-pins.

• Accessories: ..... see page 154

1:2 Colors: 21 - 23

Safety probe lead, rated 1000 V, CAT III, 19 A, have on one end a safety probe with 4 mm Multilam™ plug tip and an in-line 4mm safety plug on the other. The lead is extremely flexible 1.0 mm<sup>2</sup> cable in reinforced silicone insulation. The lead is supplied with a protective cap (MSK-4) for taking discrete reading from IC-pins.

• Accessories: ..... see page 154

1:2 Colors: 21 - 23

Safety probe lead, rated 1000 V, CAT III, 19 A, have on one end a safety probe with 4 mm Multilam™ plug tip and a right-angled 4mm safety plug on the other. The lead is highly flexible 1.0 mm<sup>2</sup> cable in double insulated PVC insulation. The lead is supplied with a protective cap (MSK-4) for taking discrete reading from IC-pins.

• Accessories: ..... see page 154







1:2 Colors: 21 - 23

Safety probe lead, rated 1000 V, CAT III, 19 A, have on one end a safety probe with 4 mm Multilam™ plug tip and a right-angled 4mm safety plug on the other. The lead is extremely flexible 1.0 mm<sup>2</sup> cable in reinforced silicone insulation. The lead is supplied with a protective cap (MSK-4) for taking discrete reading from IC-pins.

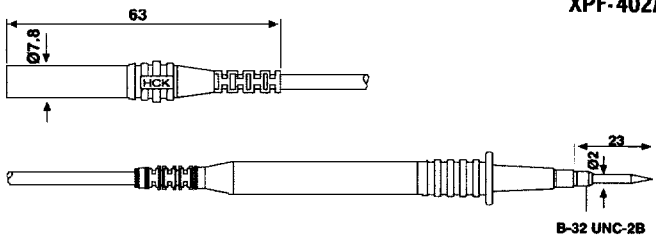
• Accessories: ..... see page 154

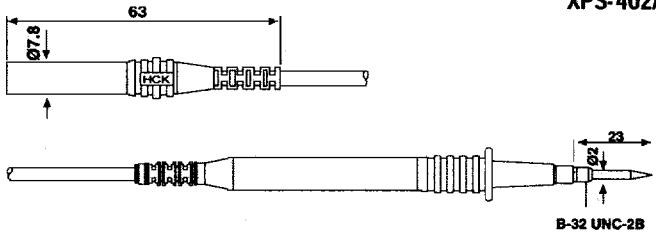
1:2 Colors: 21 - 23

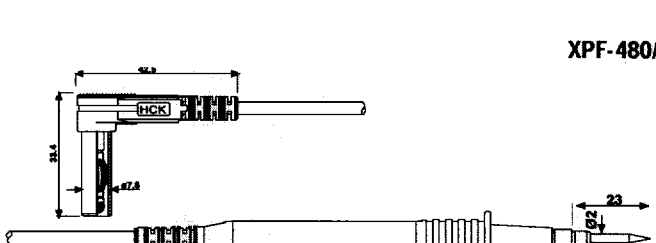
20 - green/yellow 21 - black 22 - red 23 - blue 24 - yellow 25 - green 26 - violet 27 - brown 28 - gray 29 - white 33 - transparent

Nominal diameter	Withdraw. force	Rated current	Contact resistance	Type	Part No
4 mm	-	15 A	0.8 mΩ	   1:2	XPF-402/2G 66.9614-100 (100 cm) 66.9614-150 (150 cm) 66.9614-200 (200 cm) 66.9614-300 (300 cm)
Safety probe lead, rated 1000 V, CAT II, has a 2 mm safety probe with a thread for use with screw-on accessories PSA on one end, and an in-line safety plug on the other. The lead is highly flexible 0.75 <sup>2</sup> cable in double insulated PVC insulation.					
• Accessories: ..... see page 154 Protective cap SK-2 ..... 66.9686-21 Colors: 21 - 23					
4 mm	-	15 A	0.8 mΩ		
Safety probe lead, rated 1000 V, CAT II, has a 2 mm safety probe with a thread for use with screw-on accessories PSA on one end, and an in-line safety plug on the other. The lead is extremely flexible 0.75 <sup>2</sup> cable in double insulated, reinforced silicone insulation.					
• Accessories: ..... see page 154 Protective cap SK-2 ..... 66.9686-21 Colors: 21 - 23					
4 mm	-	15 A	0.8 mΩ	   1:2	XPS-402/2G 66.9615-100 (100 cm) 66.9615-150 (150 cm) 66.9615-200 (200 cm) 66.9615-300 (300 cm)
Safety probe lead, rated 1000 V, CAT II, has a 2 mm safety probe with a thread for use with screw-on accessories PSA on one end, and an in-line safety plug on the other. The lead is extremely flexible 0.75 <sup>2</sup> cable in double insulated, reinforced silicone insulation.					
• Accessories: ..... see page 154 Protective cap SK-2 ..... 66.9686-21 Colors: 21 - 23					
4 mm	-	15 A	0.8 mΩ		
Safety probe lead, rated 1000 V, CAT II, has a 2 mm safety probe with a thread for use with screw-on accessories PSA on one end, and a right-angled safety plug on the other. The lead is highly flexible 0.75 <sup>2</sup> cable in double insulated PVC insulation.					
• Accessories: ..... see page 154 Protective cap SK-2 ..... 66.9686-21 Colors: 21 - 23					
4 mm	-	15 A	0.8 mΩ	   1:2	XPF-480/2G 66.9645-100 (100 cm) 66.9645-150 (150 cm) 66.9645-200 (200 cm) 66.9645-300 (300 cm)
Safety probe lead, rated 1000 V, CAT II, has a 2 mm safety probe with a thread for use with screw-on accessories PSA on one end, and a right-angled safety plug on the other. The lead is highly flexible 0.75 <sup>2</sup> cable in double insulated PVC insulation.					
• Accessories: ..... see page 154 Protective cap SK-2 ..... 66.9686-21 Colors: 21 - 23					
4 mm	-	15 A	0.8 mΩ		
Safety probe lead, rated 1000 V, CAT II, has a 2 mm safety probe with a thread for use with screw-on accessories PSA on one end, and a right-angled safety plug on the other. The lead is extremely flexible 0.75 <sup>2</sup> cable in double insulated, reinforced silicone insulation.					
• Accessories: ..... see page 154 Protective cap SK-2 ..... 66.9686-21 Colors: 21 - 23					