

**Features**

Timer modules for use in conjunction with relay & socket.

**86.00 - Multi-function & multi-voltage timer module**

**86.30 - Bi-function & multi-voltage timer module**

- Timer module type 86.00 for 90, 92, 96 series sockets and type 86.30 for 90, 92, 94, 95, 96, 97 series sockets
- Wide supply voltage range: 12...240 V AC/DC (86.00) 12...24 V AC/DC or 230...240 V AC (86.30)
- LED indicator

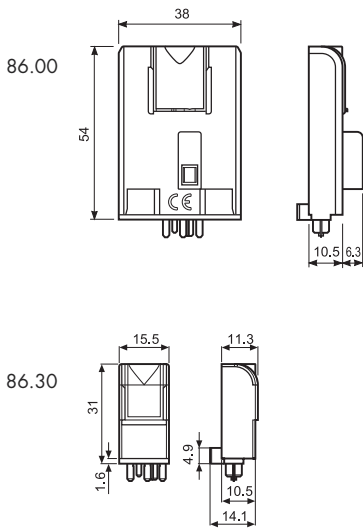

**86.00**



- Time scale: from 0.05s to 100h
- Multi-function
- Plug-in for use with 90.02, 90.03, 92.03 and 96.04 sockets

**86.30**



- Time scale: from 0.05s to 100h
- Bi-function
- Plug-in for use with 90.02, 90.03, 92.03, 94.02, 94.03, 94.04, 94.54, 95.03, 95.05, 95.55, 96.02, 96.04, 97.01, 97.02, 97.51 and 97.52 sockets

- AI:** On-delay  
**DI:** Interval  
**SW:** Symmetrical flasher (starting pulse on)  
**BE:** Off-delay with control signal  
**CE:** On- and off-delay with control signal  
**DE:** Interval with control signal on  
**EE:** Interval with control signal off  
**FE:** Interval with control signal on and off

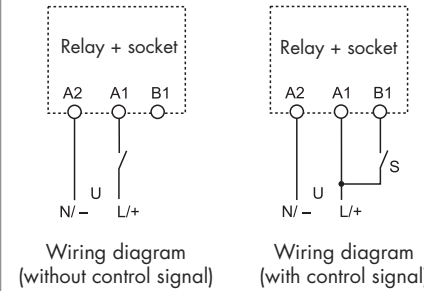

- AI:** On-delay  
**DI:** Interval

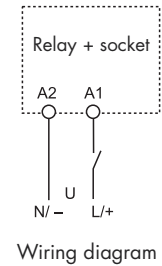

**Contact specification**

Contact configuration	
Rated current/Maximum peak current	A
Rated voltage/Maximum switching voltage V AC	
Rated load AC1	VA
Rated load AC15 (230 V AC)	VA
Single phase motor rating (230 V AC)	kW
Breaking capacity DC1: 30/110/220 V	A
Minimum switching load	mW (V/mA)
Standard contact material	

**Supply specification**

Nominal voltage (U <sub>N</sub> )	V AC (50/60 Hz)			
	V DC			
Rated power AC/DC	W			
Operating range	V AC (50/60 Hz)			
	DC			

**Technical data**

Specified time range				
Repeatability	%			
Recovery time	ms			
Minimum control impulse	ms			
Setting accuracy full range	%			
Electrical life at rated load in AC1	cycles			
Ambient temperature range	°C			
Protection category				

See 56, 60 and 62 series relays  
 Note: Do not use with relays 62.3x.x012.x300 and 62.3x.x012.x600

See 40, 44, 46, 55, 56, 60 and 62 series relays

**Approvals** (according to type)



### Ordering information

Example: 86 series multi-function timer module, (12...240)V AC/DC supply voltage.

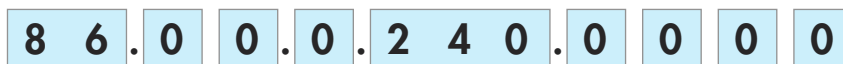

**Series** —————  
**Type** —————  
 0 = Multi-function (AI, DI, SW, BE, CE, DE, EE, FE)  
 3 = Bi-function (AI, DI)  
**No. of poles** —————  
 See 40, 44, 46, 55, 56, 60 and 62 series relays  
 Poles for chosen relay/socket combination -  
 according to chart below

**Supply voltage**  
 024 = (12...24)V AC/DC (86.30 only)  
 120 = (110...125)V AC (86.30 only)  
 240 = (12...240)V AC/DC (86.00 only)  
 240 = (230...240)V AC (86.30 only)  
**Supply version**  
 0 = AC (50/60 Hz)/DC  
 8 = AC (50/60 Hz)

### Combinations

Number of poles	Relay type	Socket type	Timer module
1	40.31	95.03	86.30
1	40.61	95.05	86.30
1	46.61	97.01/97.51	86.30
2	40.52/44.52/44.62	95.05/95.55	86.30
2	46.52	97.02/97.52	86.30
2	55.32	94.02/94.54	86.30
2	56.32	96.02	86.30
2	60.12	90.02	86.00/86.30
2	62.32	92.03	86.00/86.30
3	55.33	94.03	86.30
3	60.13	90.03	86.00/86.30
3	62.33	92.03	86.00/86.30
4	55.34	94.04/94.54	86.30
4	56.34	96.04	86.00/86.30

### Technical data

#### EMC specifications

Type of test	Reference standard	86.00	86.30	
Electrostatic discharge	contact discharge	EN 61000-4-2	4 kV	n.a.
	air discharge	EN 61000-4-2	8 kV	8 kV
Radio-frequency electromagnetic field (80 ÷ 1,000 MHz)	EN 61000-4-3	10 V/m	10 V/m	
Fast transients (burst) (5-50 ns, 5 kHz) on Supply terminals	EN 61000-4-4	4 kV	2 kV	
Surges (1.2/50 µs) on Supply terminals	common mode	EN 61000-4-5	4 kV	2 kV
	differential mode	EN 61000-4-5	4 kV	1 kV
Radio-frequency common mode (0.15 ÷ 80 MHz) on Supply terminals	EN 61000-4-6	10 V	10 V	
Radiated and conducted emission	EN 55022	class B	class B	
<b>Other data</b>	<b>86.00</b>	<b>86.30</b>		
Current absorption on signal control (B1)	mA	1	—	
Power lost to the environment	without contact current	W	0.1 (12 V) - 1 (230 V)	0.2
	with rated current		See 56, 60 and 62 series relays	See 40, 44, 46, 55, 56, 60, 62 series relays

### Time scales

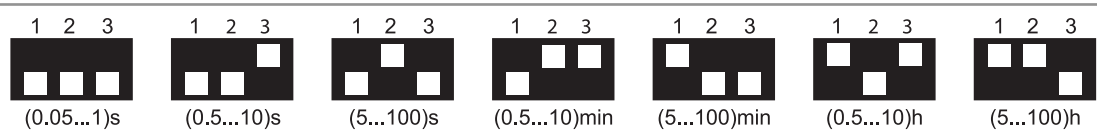

NOTE: Time scales and functions must be set before energising the timer.  
 To achieve the minimum time setting of 0.05 seconds it is necessary to use one of the functions with control signal.  
 When setting very short times it may be necessary to take into account the operate time of the relay used.

Functions

- U = Supply voltage
- S = Signal switch
- = Output contact

LED Type 86.00	LED Type 86.30	Supply voltage	NO output contact
		OFF	Open
		ON	Open
		ON	Open (timing in progress)
		ON	Closed

Without control signal = Start via contact in supply line (A1).  
 With control signal = Start via contact into control terminal (B1).

Wiring diagram

Type 86.00

Without control signal

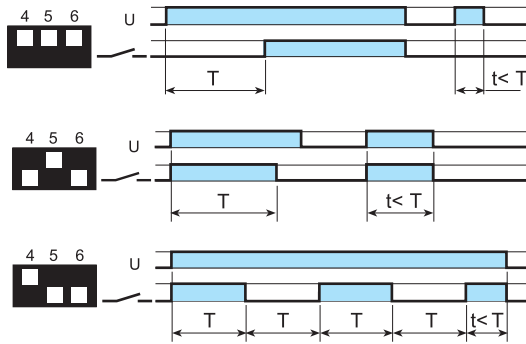
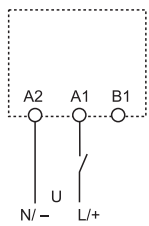

- (AI) On-delay.**  
Apply power to timer. Output contacts transfer after preset time has elapsed. Reset occurs when power is removed.
- (DI) Interval.**  
Apply power to timer. Output contacts transfer immediately. After the preset time has elapsed, contacts reset.
- (SW) Symmetrical flasher (starting pulse on).**  
Apply power to timer. Output contacts transfer immediately and cycle between ON and OFF for as long as power is applied. The ratio is 1:1 (time on = time off).

With control signal

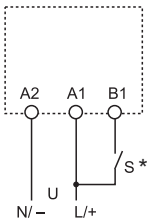

\* With DC supply, positive polarity has to be connected to B1 terminal (according to EN 60204-1). Switch S should be exclusively used to provide the control signal to terminal B1. (Do not connect any other load at this point).

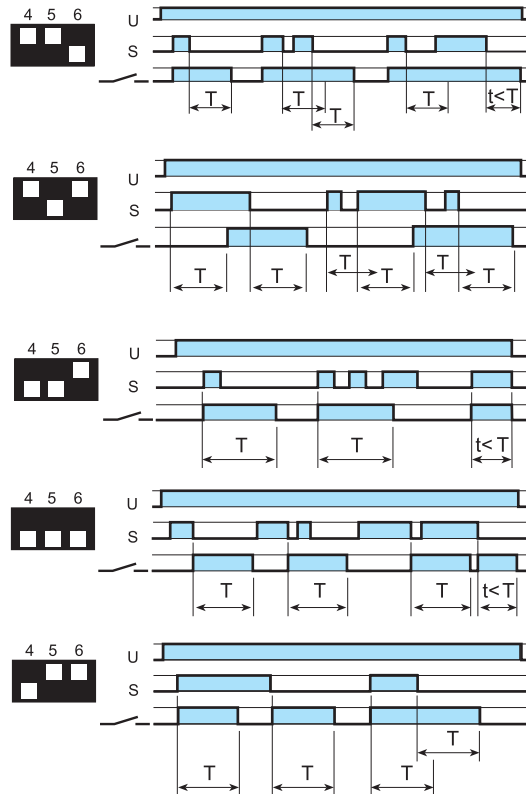

- (BE) Off-delay with control signal.**  
Power is permanently applied to the timer. The output contacts transfer immediately on closure of the Signal Switch (S). Opening the Signal Switch initiates the preset delay, after which time the output contacts reset.
- (CE) On- and off-delay with control signal.**  
Power is permanently applied to the timer. Closing the Signal Switch (S) initiates the preset delay, after which time the output contacts transfer. Opening the Signal switch initiates the same preset delay, after which time the output contacts reset.
- (DE) Interval with control signal on.**  
Power is permanently applied to the timer. On momentary or maintained closure of Signal Switch (S), the output contacts transfer, and remain so for the duration of the preset delay, after which they reset.
- (EE) Interval with control signal off.**  
Power is permanently applied to the timer. On opening of the Signal Switch (S) the output contacts transfer, and remain so for the duration of the preset delay, after which they reset.
- (FE) Interval with control signal on and off.**  
Power is permanently applied to the timer. Both the opening and closing of the Signal Switch (S) initiates the transfer of the output contacts. In both instances the contacts reset after the delay period has elapsed.

Wiring diagram

Type 86.30

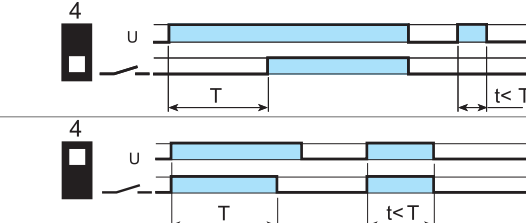
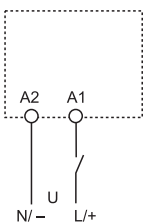

- (AI) On-delay.**  
Apply power to timer. Output contacts transfer after preset time has elapsed. Reset occurs when power is removed.
- (DI) Interval.**  
Apply power to timer. Output contacts transfer immediately. After the preset time has elapsed, contacts reset.



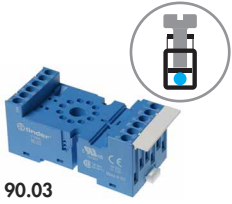

90.03

Approvals  
(according to type):



<b>Screw terminal (Box clamp) socket</b> panel or 35 mm rail (EN 60715) mount For relay type	<b>90.02</b> <b>Blue</b>	<b>90.02.0</b> <b>Black</b>	<b>90.03</b> <b>Blue</b>	<b>90.03.0</b> <b>Black</b>
	60.12		60.13	
<b>Accessories</b>				
Metal retaining clip	090.33			
6-way jumper link	090.06			
Identification tag	090.00.2			
Timer module	86.00, 86.30			
<b>Technical data</b>				
Double terminal A1 (for easy start connection)				
Rated values	10 A - 250 V			
Dielectric strength	2 kV AC			
Protection category	IP 20			
Ambient temperature	°C -40...+70			
⊕ Screw torque	Nm 0.6			
Wire strip length	mm 10			
Max. wire size for 90.02 and 90.03 sockets	solid wire		stranded wire	
	mm <sup>2</sup>	1x6 / 2x2.5	1x4 / 2x2.5	
	AWG	1x10 / 2x14	1x12 / 2x14	

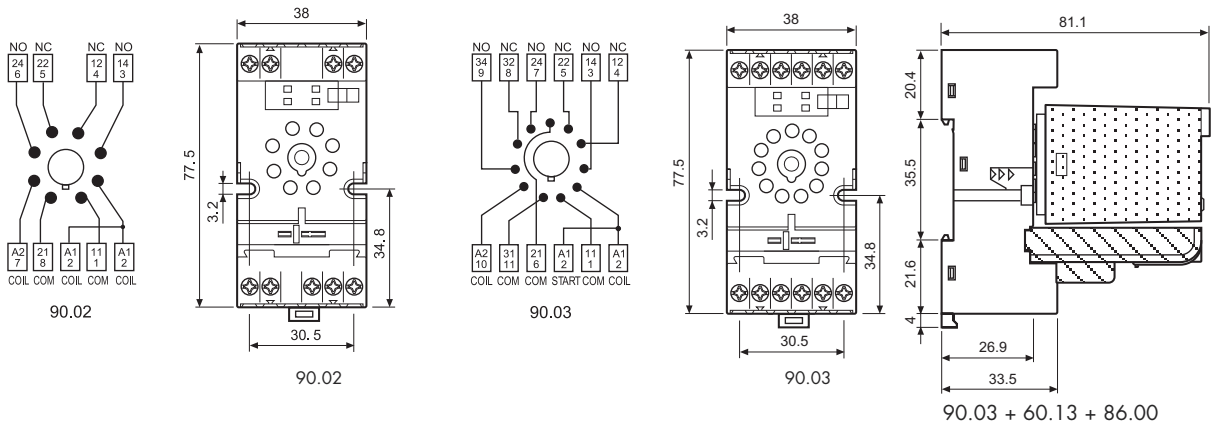

H

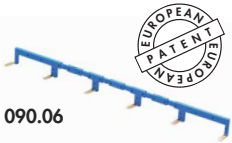

090.06

Approvals  
(according to type):



<b>6-way jumper link</b> for 90.02 and 90.03 sockets	090.06
Rated values	10 A - 250 V

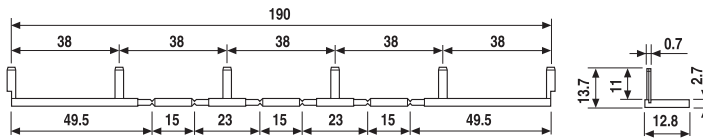

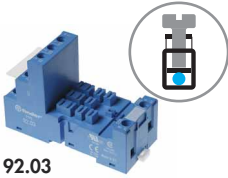

**92.03**

Approvals  
(according to type):



<b>Screw terminal (Box clamp) socket</b>	<b>92.03</b>	<b>92.03.0</b>	
panel or 35 mm rail (EN 60715) mount	<b>Blue</b>	<b>Black</b>	
For relay type	62.32, 62.33		
<b>Accessories</b>			
Metal retaining clip (supplied with socket - packaging code SMA)	092.71		
Identification tag	092.00.2		
Timer modules	86.00, 86.30		
<b>Technical data</b>			
Rated values	16 A - 250 V		
Dielectric strength	6 kV (1.2/50 μs) between coil and contacts		
Protection category	IP 20		
Ambient temperature	°C	-40...+70 (see diagram L92)	
⊕ Screw torque	Nm	0.8	
Wire strip length	mm	10	
Max. wire size for 92.03 socket	solid wire	stranded wire	
	mm <sup>2</sup>	1x10 / 2x4	1x6 / 2x4
	AWG	1x8 / 2x12	1x10 / 2x12

**L 92 - Rated current vs ambient temperature**

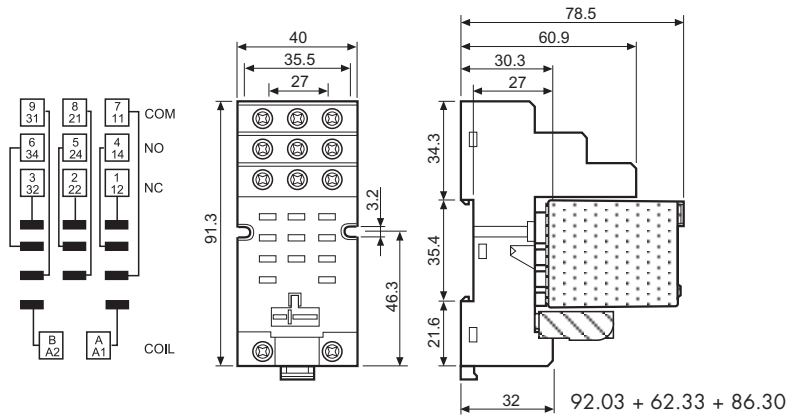
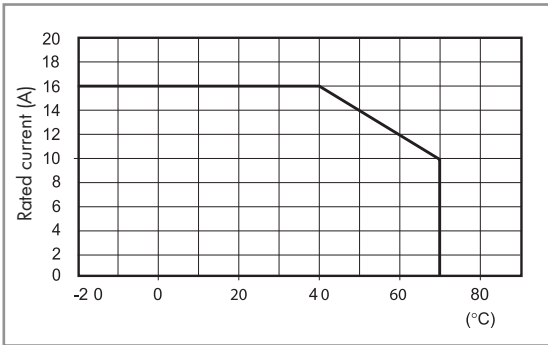

86 Series - Sockets and accessories



94.04

Approvals  
(according to type):



094.91.3



060.72

Screw terminal (Box clamp) socket	94.02	94.02.0	94.03	94.03.0	94.04	94.04.0
panel or 35 mm rail (EN 60715) mount	Blue	Black	Blue	Black	Blue	Black
For relay type	55.32		55.33		55.32, 55.34	
<b>Accessories</b>						
Metal retaining clip	094.71					
Plastic retaining and release clip (supplied with socket - packaging code SPA)	094.91.3	094.91.30	094.91.3	094.91.30	094.91.3	094.91.30
6-way jumper link	094.06	094.06.0	094.06	094.06.0	094.06	094.06.0
Identification tag	094.00.4					
Timer modules	86.30					
Sheet of marker tags for retaining and release clip 094.01 plastic, 72 tags, 6x12 mm	060.72					
<b>Technical data</b>						
Rated values	10 A - 250 V					
Dielectric strength	2 kV AC					
Protection category	IP 20					
Ambient temperature	°C -40...+70					
⊕ Screw torque	Nm 0.5					
Wire strip length	mm 8					
Max. wire size for 94.02/03/04 sockets	solid wire		stranded wire			
	mm <sup>2</sup> 1x6 / 2x2.5		1x4 / 2x2.5			
	AWG 1x10 / 2x14		1x12 / 2x14			

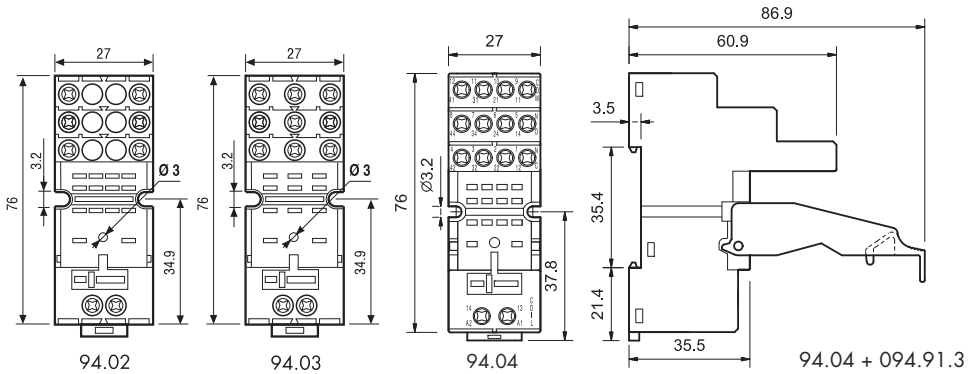
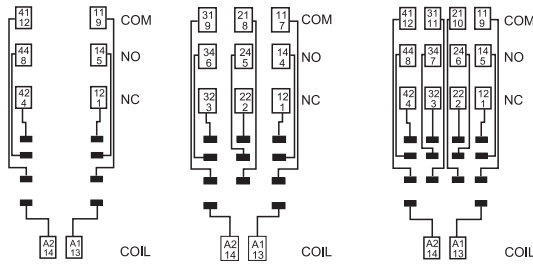

094.06



6-way jumper link for 94.02, 94.03 and 94.04 sockets	094.06 (blue)	094.06.0 (black)
Rated values	10 A - 250 V	

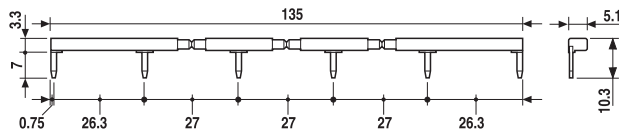



94.54

Approvals  
(according to type):



094.91.3



060.72

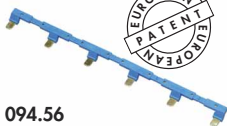
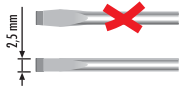

094.56



<b>Screwless terminal socket</b> 35 mm rail (EN 60715) mount	<b>94.54 (blue)</b>	
For relay type	55.32, 55.34	
<b>Accessories</b>		
Metal retaining clip	094.71	
Plastic retaining and release clip	094.91.3	
6-way jumper link	094.56	
Modules (see table below)	99.02, 86.30	
Sheet of marker tags, 72 tags, 6x12 mm	060.72	
<b>Technical data</b>		
Rated values	10 A - 250 V	
Dielectric strength	2 kV AC	
Protection category	IP 20	
Ambient temperature	°C -25...+70	
Wire strip length	mm 10	
Max. wire size for 94.54 socket	solid wire	stranded wire
	mm <sup>2</sup>	2x(0.2...1.5)
	AWG	2x(24...14)

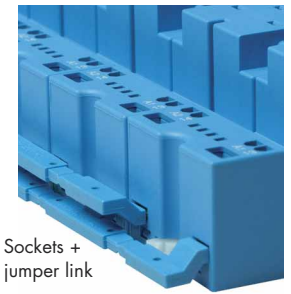
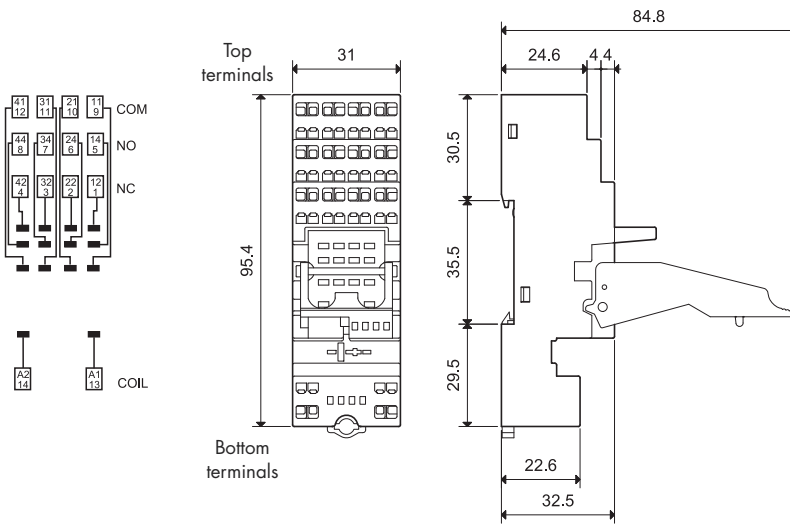

Sockets + jumper link

<b>6-way jumper link</b>	<b>094.56 (blue)</b>
Rated values	10 A - 250 V

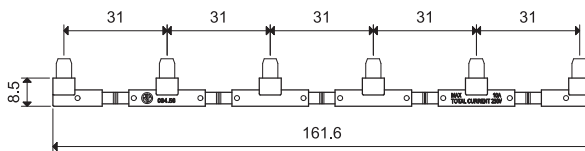

H

86 Series - Sockets and accessories



95.05

Approvals  
(according to type):



095.01

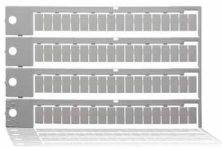

060.72

Screw terminal (Box clamp) socket	95.03	95.03.0	95.05	95.05.0
panel or 35 mm rail (EN 60715) mount	Blue	Black	Blue	Black
For relay type	40.31		40.51/ 52/ 61, 44.52/62	
<b>Accessories</b>				
Metal retaining clip	095.71			
Plastic retaining and release clip (supplied with socket - packaging code SPA)	095.01	095.01.0	095.01	095.01.0
8-way jumper link	095.18	095.18.0	095.18	095.18.0
Identification tag	095.00.4			
Timer modules	86.30			
Sheet of marker tags for retaining and release clip 095.01 plastic, 72 tags, 6x12 mm	060.72			
<b>Technical data</b>				
Rated values	10 A - 250 V *			
Dielectric strength	6 kV (1.2/50 μs) between coil and contacts			
Protection category	IP 20			
Ambient temperature	°C -40...+70			
⊕ Screw torque	Nm 0.5			
Wire strip length	mm 8			
Max. wire size for 95.03 and 95.05 sockets	solid wire		stranded wire	
	mm <sup>2</sup>	1x6 / 2x2.5	1x4 / 2x2.5	
	AWG	1x10 / 2x14	1x12 / 2x14	

\* For currents >10 A, contact terminals must be connected in parallel (21 with 11, 24 with 14, 22 with 12).

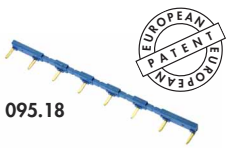
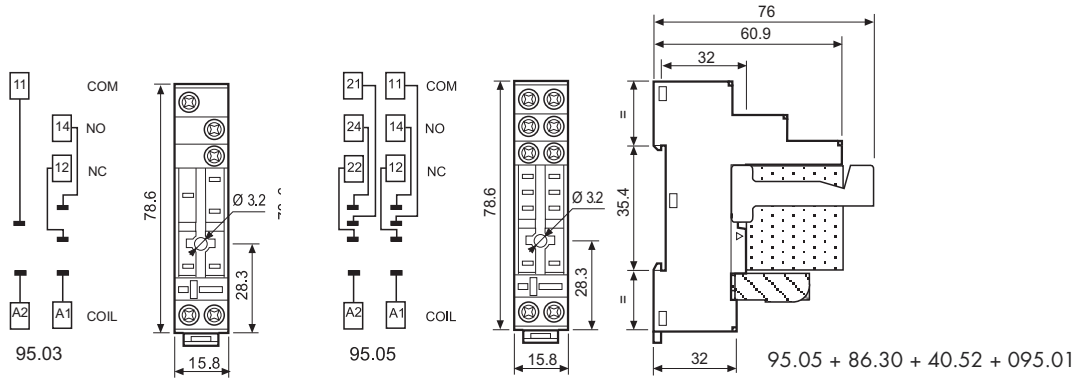

095.18



8-way jumper link for 95.03 and 95.05 sockets	095.18 (blue)	095.18.0 (black)
Rated values	10 A - 250 V	

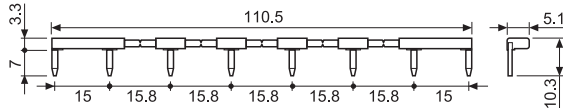





**95.55**

Approvals  
(according to type):



**095.91.3**



**060.72**

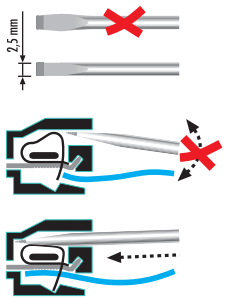

<b>Screwless terminal socket</b>	<b>95.55</b>	<b>95.55.0</b>
panel or 35 mm rail (EN 60715) mount	<b>Blue</b>	<b>Black</b>
For relay type	40.51/52/61, 44.52/62	
<b>Accessories</b>		
Metal retaining clip		095.71
Plastic retaining and release clip (supplied with socket - packaging code SPA)	095.91.3	095.91.30
Timer modules		86.30
Sheet of marker tags for retaining and release clip 095.91.3 plastic, 72 tags, 6x12 mm		060.72
<b>Technical data</b>		
Rated values	10 A - 250 V	
Dielectric strength	6 kV (1.2/50 μs) between coil and contacts	
Protection category	IP 20	
Ambient temperature	°C	-25...+70
Wire strip length	mm	8
Max. wire size for 95.55 socket	solid wire	stranded wire
	mm <sup>2</sup>	2x(0.2...1.5)
	AWG	2x(24...18)

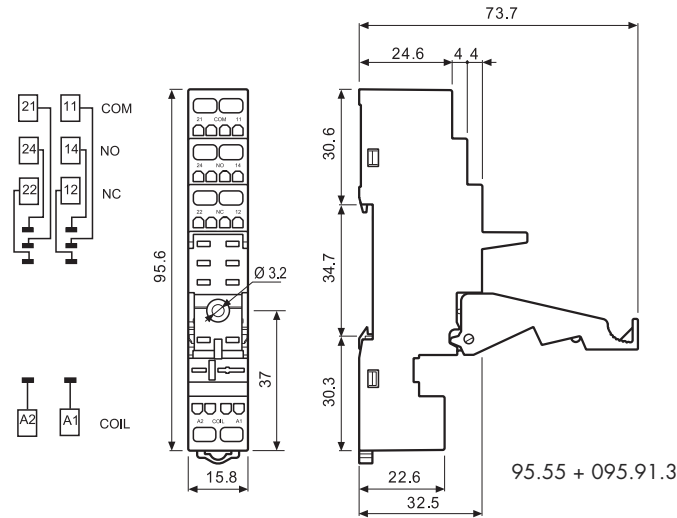



96.02  
Approvals  
(according to type):

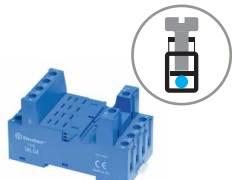

96.04  
Approvals  
(according to type):



094.91.3

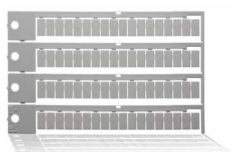

060.72

Screw terminal (Box clamp) socket	96.02	96.02.0	96.04	96.04.0
panel or 35 mm rail (EN 60715) mount	Blue	Black	Blue	Black
For relay type	56.32		56.34	
<b>Accessories</b>				
Metal retaining clip (supplied with socket - packaging code SMA)	094.71		096.71	
Plastic retaining and release clip (supplied with socket - packaging code SPA)	094.91.3	094.91.30	—	—
6-way jumper link	094.06	094.06.0	—	—
Identification tag	095.00.4		090.00.2	
Timer modules	86.30		86.00, 86.30	
Sheet of marker tags for retaining and release clip 094.91.3 plastic, 72 tags, 6x12 mm	060.72		—	
<b>Technical data</b>				
Rated values	12 A - 250 V			
Dielectric strength	2 kV AC			
Protection category	IP 20			
Ambient temperature	°C -40...+70			
⊕ Screw torque	Nm 0.8			
Wire strip length	mm 8			
Max. wire size for 96.02/04 sockets	solid wire		stranded wire	
	mm <sup>2</sup> 1x6 / 2x2.5		1x4 / 2x2.5	
	AWG 1x10 / 2x14		1x12 / 2x14	

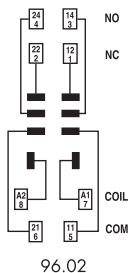

96.02

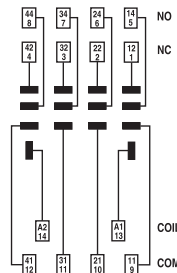

96.04

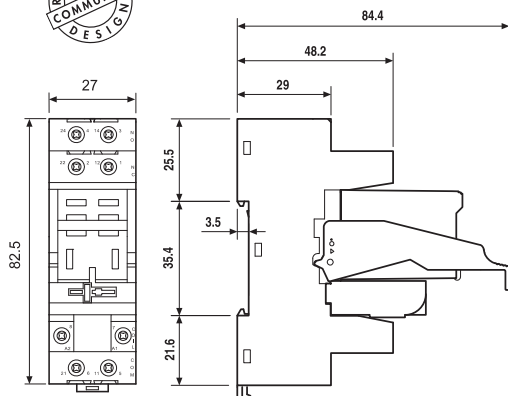

96.02

96.02 + 56.32 + 094.91.3 + 86.30

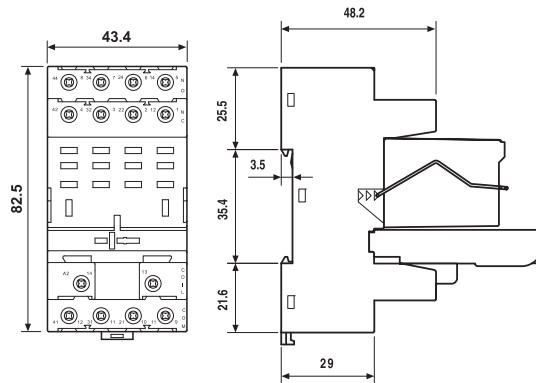

96.04

96.04 + 56.34 + 096.71 + 86.00

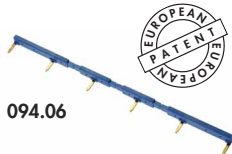

094.06



6-way jumper link for 96.02 socket	094.06 (blue)	094.06.0 (black)
Rated values	10 A - 250 V	

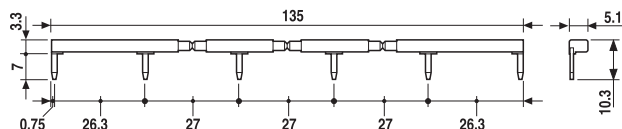

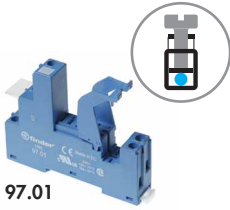

97.01  
Approvals  
(according to type):



<b>Screw terminal socket</b>	<b>97.01</b>	<b>97.02</b>
panel or 35 mm rail (EN 60715) mount	<b>Blue</b>	<b>Blue</b>
For relay type	46.61	46.52
<b>Accessories</b>		
Plastic retain and eject clip (supplied with socket - packaging code SPA)	097.01	
8-way jumper link	095.18 (blue)	095.18.0 (black)
Identification tag	095.00.4	
Timer modules	86.30	
<b>Technical data</b>		
Rated current	16 A - 250 V AC	8 A - 250 V AC
Dielectric strength	6 kV (1.2/50 μs) between coil and contacts	
Protection category	IP 20	
Ambient temperature	°C -40...+70 (see diagram L97)	
⊕ Screw torque	Nm 0.8	
Wire strip length	mm 8	
Max. wire size for 97.01 and 97.02 sockets	solid wire	stranded wire
	mm <sup>2</sup> 1x6 / 2x2.5	1x4 / 2x2.5
	AWG 1x10 / 2x14	1x12 / 2x14

L 97 - Rated current vs ambient temperature  
(for 46.61 relay / 97.01 socket combination)

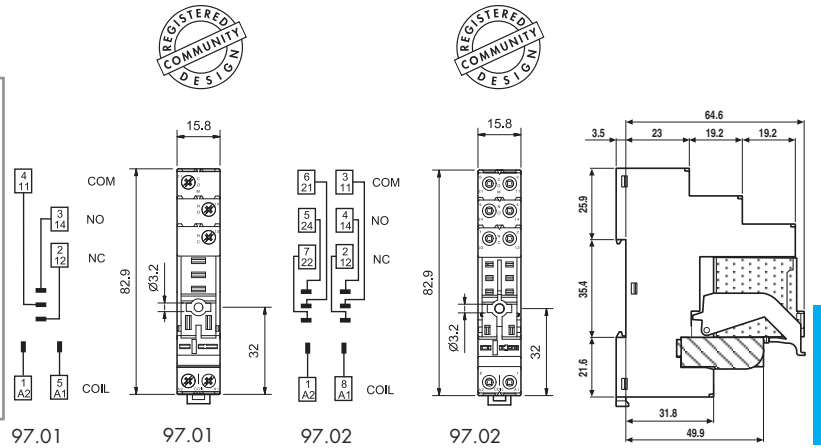
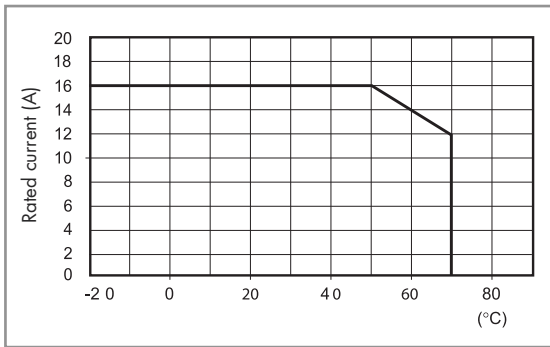

97.02 + 46.52 + 097.01 + 86.30

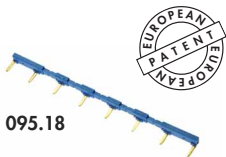

095.18

<b>8-way jumper link for 97.01 and 97.02 sockets</b>	<b>095.18 (blue)</b>	<b>095.18.0 (black)</b>
Rated values	10 A - 250 V	

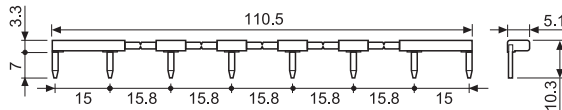

86 Series - Sockets and accessories

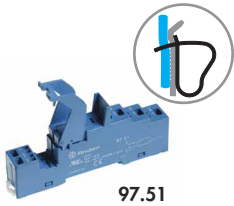

97.51

Approvals  
(according to type):



097.01

<b>Screwless terminal socket</b>	<b>97.51</b>	<b>97.52</b>
panel or 35 mm rail (EN 60715) mount	<b>Blue</b>	<b>Blue</b>
For relay type	46.61	46.52
<b>Accessories</b>		
Plastic retain and eject clip (supplied with socket - packaging code SPA)	097.01	
Timer modules	86.30	
<b>Technical data</b>		
Rated current	10 A - 250 V AC	8 A - 250 V AC
Dielectric strength	6 kV (1.2/50 μs) between coil and contacts	
Protection category	IP 20	
Ambient temperature	°C -25...+70	
Wire strip length	mm 8	
Max. wire size for 97.51 and 97.52 sockets	solid wire	stranded wire
	mm <sup>2</sup> 2x(0.2...1.5)	2x(0.2...1.5)
	AWG 2x(24...18)	2x(24...18)

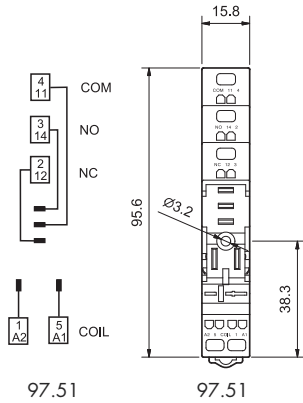
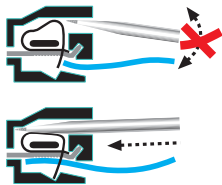
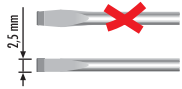

97.51

97.51

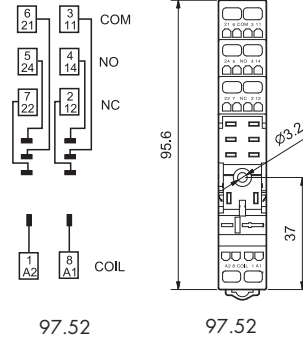

97.52

97.52

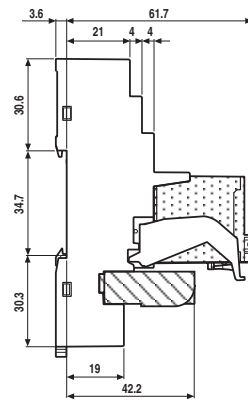

97.52 + 46.52 + 097.01 + 86.30