

## Features

### Plug-in mount 10 A General purpose relay

- 2 & 3 pole changeover contacts
- Cadmium Free contacts (preferred version)
- AC coils & DC coils
- UL Listing (certain relay/socket combinations)
- Contact material options
- Lockable test button with mechanical flag indicator (preferred version)
- 90 series sockets
- Coil EMC suppression
- Timer accessories 86 series
- European Patent

60.12



- 2 pole, 10 A power contacts
- 8 pin plug-in

60.13



- 3 pole, 10 A power contacts
- 11 pin plug-in

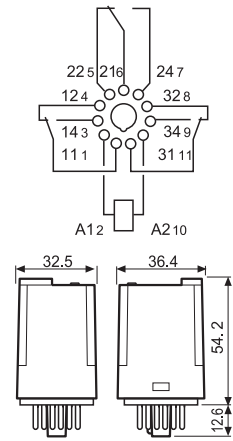
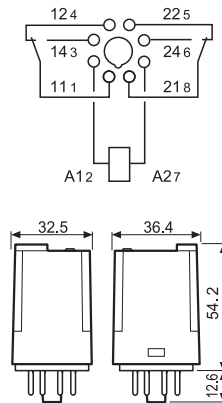

FOR UL RATINGS SEE:  
"General technical information" page V

Contact specification		60.12	60.13
Contact configuration		2 CO (DPDT)	3 CO (3PDT)
Rated current/Maximum peak current	A	10/20	10/20
Rated voltage/Maximum switching voltage	V AC	250/400	250/400
Rated load AC1	VA	2,500	2,500
Rated load AC15 (230 V AC)	VA	500	500
Single phase motor rating (230 V AC)	kW	0.37	0.37
Breaking capacity DC1: 30/110/220 V	A	10/0.4/0.15	10/0.4/0.15
Minimum switching load	mW (V/mA)	500 (10/5)	500 (10/5)
Standard contact material		AgNi	AgNi
Coil specification		60.12	60.13
Nominal voltage (U <sub>N</sub> )	V AC (50/60 Hz)	6 - 12 - 24 - 48 - 60 - 110 - 120 - 230 - 240 - 400	
	V DC	6 - 12 - 24 - 48 - 60 - 110 - 125 - 220	
Rated power AC/DC	VA (50 Hz)/W	2.2/1.3	2.2/1.3
Operating range	AC	(0.8...1.1)U <sub>N</sub>	(0.8...1.1)U <sub>N</sub>
	DC	(0.8...1.1)U <sub>N</sub>	(0.8...1.1)U <sub>N</sub>
Holding voltage	AC/DC	0.8 U <sub>N</sub> /0.5 U <sub>N</sub>	0.8 U <sub>N</sub> /0.5 U <sub>N</sub>
Must drop-out voltage	AC/DC	0.2 U <sub>N</sub> /0.1 U <sub>N</sub>	0.2 U <sub>N</sub> /0.1 U <sub>N</sub>
Technical data		60.12	60.13
Mechanical life AC/DC	cycles	20 · 10 <sup>6</sup> /50 · 10 <sup>6</sup>	20 · 10 <sup>6</sup> /50 · 10 <sup>6</sup>
Electrical life at rated load AC1	cycles	200 · 10 <sup>3</sup>	200 · 10 <sup>3</sup>
Operate/release time	ms	11/4	11/4
Insulation between coil and contacts (1.2/50 μs)	kV	4	3.6
Dielectric strength between open contacts	V AC	1,000	1,000
Ambient temperature range	°C	-40...+70	-40...+70
Environmental protection		RT I	RT I

Approvals (according to type)



## Features

### Plug-in mount - 6 A

### Bifurcated contacts for low level switching

- 2 & 3 pole changeover contacts
- Cadmium Free contacts (Gold plated Silver Nickel)
- AC coils & DC coils
- Lockable test button with mechanical flag indicator (preferred version)
- 90 series sockets
- Coil EMC suppression
- Timer accessories 86 series
- European Patent

60.12 - 5200



- 2 pole, 6 A bifurcated contacts
- 8 pin plug-in

60.13 - 5200



- 3 pole, 6 A bifurcated contacts
- 11 pin plug-in

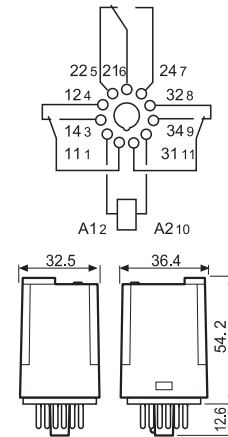
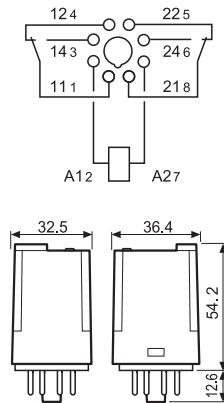

FOR UL RATINGS SEE:  
"General technical information" page V

Contact specification		60.12 - 5200	60.13 - 5200
Contact configuration		2 CO (DPDT)	3 CO (3PDT)
Rated current/Maximum peak current	A	6/10	6/10
Rated voltage/Maximum switching voltage	V AC	250/400	250/400
Rated load AC1	VA	1,500	1,500
Rated load AC15 (230 V AC)	VA	250	250
Single phase motor rating (230 V AC)	kW	0.185	0.185
Breaking capacity DC1: 30/110/220 V	A	6/0.3/0.12	6/0.3/0.12
Minimum switching load	mW (V/mA)	50 (5/5)	50 (5/5)
Standard contact material		AgNi + Au (5 µm) bifurcated contacts	AgNi + Au (5 µm) bifurcated contacts
Coil specification		60.12 - 5200	60.13 - 5200
Nominal voltage (U <sub>N</sub> )	V AC (50/60 Hz)	6 - 12 - 24 - 48 - 60 - 110 - 120 - 230 - 240 - 400	
	V DC	6 - 12 - 24 - 48 - 60 - 110 - 125 - 220	
Rated power AC/DC	VA (50 Hz)/W	2.2/1.3	2.2/1.3
Operating range	AC	(0.8...1.1)U <sub>N</sub>	
	DC	(0.8...1.1)U <sub>N</sub>	
Holding voltage	AC/DC	0.8 U <sub>N</sub> /0.5 U <sub>N</sub>	0.8 U <sub>N</sub> /0.5 U <sub>N</sub>
Must drop-out voltage	AC/DC	0.2 U <sub>N</sub> /0.1 U <sub>N</sub>	0.2 U <sub>N</sub> /0.1 U <sub>N</sub>
Technical data		60.12 - 5200	60.13 - 5200
Mechanical life AC/DC	cycles	20 · 10 <sup>6</sup> /50 · 10 <sup>6</sup>	20 · 10 <sup>6</sup> /50 · 10 <sup>6</sup>
Electrical life at rated load AC1	cycles	250 · 10 <sup>3</sup>	250 · 10 <sup>3</sup>
Operate/release time	ms	11/4	11/4
Insulation between coil and contacts (1.2/50 µs)	kV	4	3.6
Dielectric strength between open contacts	V AC	1,000	1,000
Ambient temperature range	°C	-40...+70	-40...+70
Environmental protection		RT I	RT I

Approvals (according to type)



## Features

### Flange mount - General purpose relay 10 A

- Faston 187, 4.8x0.8 mm
- 2 & 3 pole changeover contacts
- AC coils & DC coils
- Cadmium Free contacts (preferred version)
- Contacts material options

60.62



- 2 pole, 10 A power contacts
- Flange mount/Faston 187

60.63



- 3 pole, 10 A power contacts
- Flange mount/Faston 187

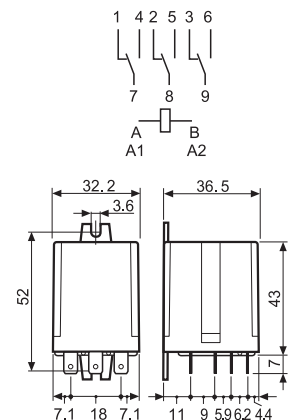
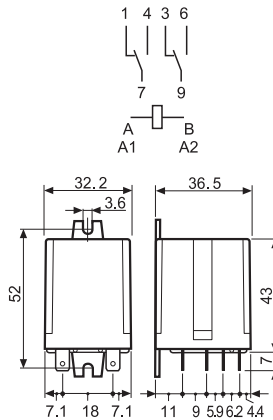

FOR UL RATINGS SEE:  
"General technical information" page V

Contact specification		60.62	60.63
Contact configuration		2 CO (DPDT)	3 CO (3PDT)
Rated current/Maximum peak current	A	10/20	10/20
Rated voltage/Maximum switching voltage	V AC	250/400	250/400
Rated load AC1	VA	2,500	2,500
Rated load AC15 (230 V AC)	VA	500	500
Single phase motor rating (230 V AC)	kW	0.37	0.37
Breaking capacity DC1: 30/110/220 V	A	10/0.4/0.15	10/0.4/0.15
Minimum switching load	mW (V/mA)	500 (10/5)	500 (10/5)
Standard contact material		AgNi	AgNi
Coil specification		60.62	60.63
Nominal voltage (U <sub>N</sub> )	V AC (50/60 Hz)	6 - 12 - 24 - 48 - 60 - 110 - 120 - 230 - 240 - 400	
	V DC	6 - 12 - 24 - 48 - 60 - 110 - 125 - 220	
Rated power AC/DC	VA (50 Hz)/W	2.2/1.3	2.2/1.3
Operating range	AC	(0.8...1.1)U <sub>N</sub>	(0.8...1.1)U <sub>N</sub>
	DC	(0.8...1.1)U <sub>N</sub>	(0.8...1.1)U <sub>N</sub>
Holding voltage	AC/DC	0.8 U <sub>N</sub> /0.5 U <sub>N</sub>	0.8 U <sub>N</sub> /0.5 U <sub>N</sub>
Must drop-out voltage	AC/DC	0.2 U <sub>N</sub> /0.1 U <sub>N</sub>	0.2 U <sub>N</sub> /0.1 U <sub>N</sub>
Technical data		60.62	60.63
Mechanical life AC/DC	cycles	20 · 10 <sup>6</sup> /50 · 10 <sup>6</sup>	20 · 10 <sup>6</sup> /50 · 10 <sup>6</sup>
Electrical life at rated load AC1	cycles	200 · 10 <sup>3</sup>	200 · 10 <sup>3</sup>
Operate/release time	ms	11/4	11/4
Insulation between coil and contacts (1.2/50 μs)	kV	4	3.6
Dielectric strength between open contacts	V AC	1,000	1,000
Ambient temperature range	°C	-40...+70	-40...+70
Environmental protection		RT I	RT I

Approvals (according to type)



## Ordering information

Example: 60 series plug-in relay, 3 CO (3PDT), 12 V DC coil, test button and mechanical indicator.

<b>6</b>	<b>0</b>	<b>.</b>	<b>1</b>	<b>.</b>	<b>3</b>	<b>.</b>	<b>9</b>	<b>.</b>	<b>0</b>	<b>1</b>	<b>2</b>	<b>.</b>	<b>0</b>	<b>A</b>	<b>0</b>	<b>B</b>	<b>0</b>	<b>.</b>	<b>4</b>	<b>C</b>	<b>0</b>	<b>D</b>
<b>Series</b>		<b>Type</b>		<b>No. of poles</b>		<b>Coil version</b>		<b>Coil voltage</b>		<b>A: Contact material</b>		<b>B: Contact circuit</b>		<b>C: Options</b>		<b>D: Special versions</b>						
1 = 8/11 pin plug-in 6 = Faston 187 (4.8x0.8 mm) with flange mount		2 = 2 pole 3 = 3 pole		4 = Current sensing (60.12/13 only) 8 = AC (50/60 Hz) 9 = DC		0 = Standard 2 = AgCdO 5 = AgNi + Au (5 µm)		0 = CO (nPDT) 2 = Bifurcated contacts 60.12/13 - 6 A only		0 = None 2 = Mechanical indicator 3 = LED (AC) 4 = Lockable test button + mechanical indicator 5* = Lockable test button + LED (AC) 54* = Lockable test button + LED (AC) + mechanical indicator 6* = LED + diode (DC, polarity positive to pin 2) 7* = Lockable test button + LED + diode (DC, polarity positive to pin 2) 74* = Lockable test button + LED + diode (DC, polarity positive to pin 2) + mechanical indicator		0 = Standard		* Options not available for 220 V DC and 400 V AC versions.								

**Selecting features and options: only combinations in the same row are possible.**  
Preferred selections for best availability are shown in **bold**.

Type	Coil version	A	B	C	D
60.12/13	AC	<b>0 - 2</b>	<b>0</b>	0 - 2 - 3 - <b>4</b> - 5	<b>0</b>
	AC	0 - 2	0	54	/
	AC	5	0 - 2	0 - 2 - 3 - 4 - 5	0
	AC	5	0 - 2	54	/
	DC	<b>0 - 2</b>	<b>0</b>	0 - 2 - <b>4</b> - 6 - 7	<b>0</b>
	DC	0 - 2	0	74	/
	DC	5	0 - 2	0 - 2 - 4 - 6 - 7	0
	DC	5	0 - 2	74	/
	current sensing	0	0	4	0
60.62/63	AC-DC	<b>0 - 2 - 5</b>	<b>0</b>	<b>0</b>	<b>0</b>

### Descriptions: Options and Special versions

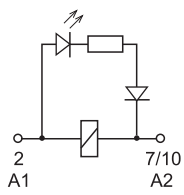

**C: Option 3, 5, 54**  
LED (AC)

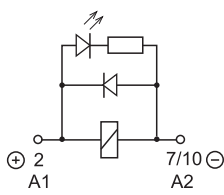

**C: Option 6, 7, 74**  
LED + diode (DC, polarity positive to pin 2)



### Lockable test button and mechanical flag indicator (0040, 0050, 0054, 0070, 0074)

The dual-purpose Finder test button can be used in two ways:

**Case 1)** The plastic pip (located directly above the test button) remains intact. In this case, when the test button is pushed, the contacts operate. When the test button is released the contacts return to their former state.

**Case 2)** The plastic pip is broken-off (using an appropriate cutting tool). In this case, (in addition to the above function), when the test button is pushed and rotated, the contacts are latched in the operating state, and remain so until the test button is rotated back to its former position. In both cases ensure that the test button actuation is swift and decisive.



## Technical data

Insulation according to EN 61810-1		2 pole		3 pole	
Nominal voltage of supply system	V AC	230/400		230/400	
Rated insulation voltage	V AC	250	400	250	400
Pollution degree		3	2	3	2
<b>Insulation between coil and contact set</b>					
Type of insulation		Basic		Basic	
Overtoltage category		III		III	
Rated impulse voltage	kV (1.2/50 $\mu$ s)	4		3.6	
Dielectric strength	V AC	2,000		2,000	
<b>Insulation between adjacent contacts</b>					
Type of insulation		Basic		Basic	
Overtoltage category		III		III	
Rated impulse voltage	kV (1.2/50 $\mu$ s)	4		3.6	
Dielectric strength	V AC	2,000		2,000	
<b>Insulation between open contacts</b>					
Type of disconnection		Micro-disconnection		Micro-disconnection	
Dielectric strength	V AC/kV (1.2/50 $\mu$ s)	1,000/1.5		1,000/1.5	
<b>Conducted disturbance immunity</b>					
Burst (5...50)ns, 5 kHz, on A1 - A2		EN 61000-4-4		level 4 (4 kV)	
Surge (1.2/50 $\mu$ s) on A1 - A2 (differential mode)		EN 61000-4-5		level 4 (4 kV)	
<b>Other data</b>					
Bounce time: NO/NC	ms	1/4			
Vibration resistance (5...55)Hz: NO/NC	g	22/22			
Shock resistance	g	20			
Power lost to the environment	without contact current	W	1.3	1.3	
	with rated current	W	2.7 (60.12, 60.62)	3.4 (60.13, 60.63)	

## Contact specification

F 60 - Electrical life (AC) v contact current

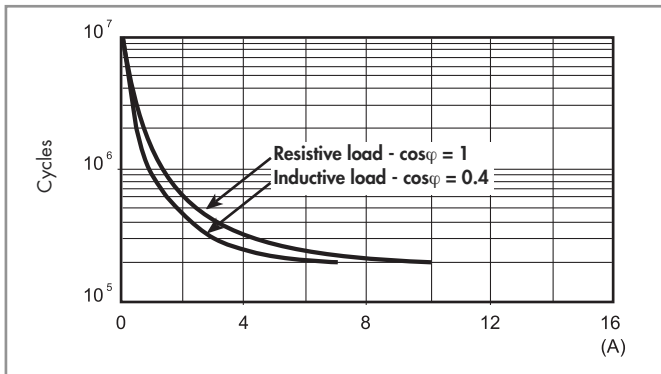

H 60 - Maximum DC1 breaking capacity

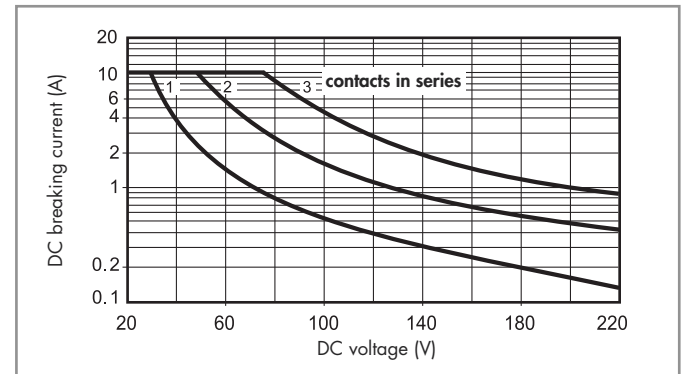

- When switching a resistive load (DC1) having voltage and current values under the curve, an electrical life of  $\geq 100 \cdot 10^3$  can be expected.
- In the case of DC13 loads, the connection of a diode in parallel with the load will permit a similar electrical life as for a DC1 load.  
Note: the release time for the load will be increased.

## Coil specifications

DC coil data

Nominal voltage $U_N$ V	Coil code	Operating range		Resistance R $\Omega$	Rated coil consumption I at $U_N$ mA
		$U_{min}$ V	$U_{max}$ V		
6	9.006	4.8	6.6	28	214
12	9.012	9.6	13.2	110	109
24	9.024	19.2	26.4	445	53.9
48	9.048	38.4	52.8	1,770	27.1
60	9.060	48	66	2,760	21.7
110	9.110	88	121	9,420	11.7
125	9.125	100	138	12,000	10.4
220	9.220	176	242	37,300	5.8

AC coil data

Nominal voltage $U_N$ V	Coil code	Operating range		Resistance R $\Omega$	Rated coil consumption I at $U_N$ (50Hz) mA
		$U_{min}$ V	$U_{max}$ V		
6	8.006	4.8	6.6	4.6	367
12	8.012	9.6	13.2	19	183
24	8.024	19.2	26.4	74	90
48	8.048	38.4	52.8	290	47
60	8.060	48	66	450	37
110	8.110	88	121	1,600	20
120	8.120	96	132	1,940	18.6
230	8.230	184	253	7,250	10.5
240	8.240	192	264	8,500	9.2
400	8.400	320	440	19,800	6

## Coil specifications

R 60 - DC coil operating range v ambient temperature

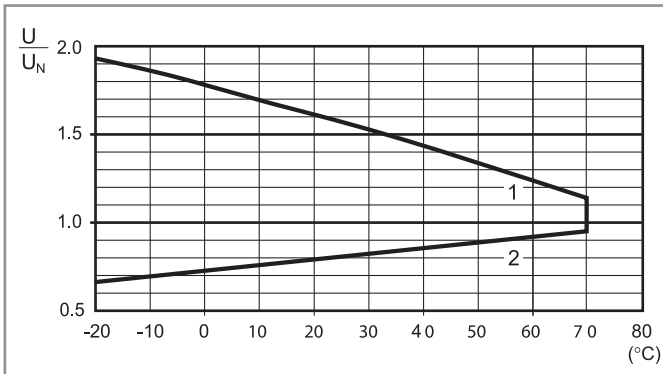

- 1 - Max. permitted coil voltage.
- 2 - Min. pick-up voltage with coil at ambient temperature.

R 60 - AC coil operating range v ambient temperature

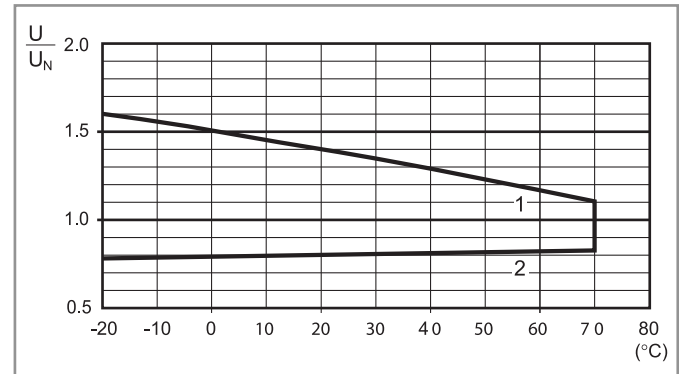

- 1 - Max. permitted coil voltage.
- 2 - Min. pick-up voltage with coil at ambient temperature.

## Current sensing version

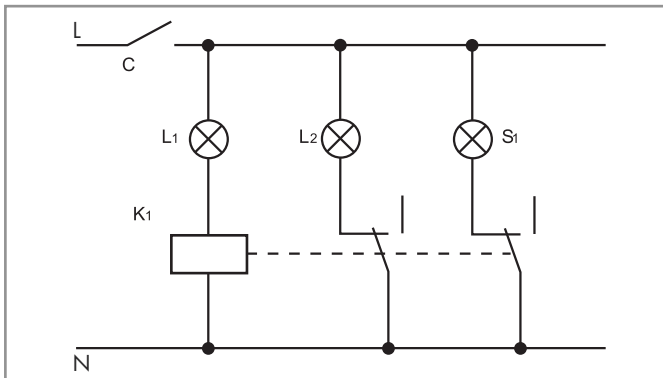

Typical application with current sensing relays.  
An open circuit filament of lamp L1 is detected by the current sensing relay coil (K1) which causes the back-up safety lamp L2 to be energised, and indication of failure at the control panel via lamp S1.

Example: navigation light.

- L1 = Light
- L2 = Safety light
- S1 = Control light
- K1 = Relay

Current sensing DC coil data

Coil code	$I_{min}$ (A)	$I_N$ (A)	$I_{max}$ (A)	R ( $\Omega$ )
4202	1.7	2.0	2.4	0.15
4182	1.5	1.8	2.2	0.19
4162	1.4	1.6	1.9	0.24
4142	1.2	1.4	1.7	0.31
4122	1.0	1.2	1.4	0.42
4102	0.85	1.0	1.2	0.61
4092	0.8	0.9	1.1	0.75
4062	0.5	0.6	0.7	1.70
4032	0.25	0.3	0.4	6.70
4012	0.085	0.1	0.15	61

Current sensing AC coil data

Coil code	$I_{min}$ (A)	$I_N$ (A)	$I_{max}$ (A)	R ( $\Omega$ )
4251	2.1	2.5	3.0	0.05
4181	1.5	1.8	2.2	0.10
4161	1.4	1.6	1.9	0.12
4121	1.0	1.2	1.4	0.22
4101	0.85	1.0	1.2	0.32
4051	0.42	0.5	0.6	1.28
4041	0.34	0.4	0.5	2.00
4031	0.25	0.3	0.4	3.57
4021	0.17	0.2	0.25	8.0
4011	0.085	0.1	0.15	32.1

Other types of current sensing relays are available on request.

## Accessories

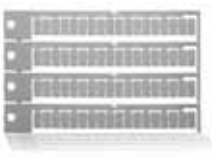

060.72

Sheet of marker tags for relay types 60.12 and 60.13, plastic, 72 tags, 6x12 mm

060.72



Module	Socket	Relay	Description	Mounting	Accessories
99.02	90.02	60.12	Screw terminal (Box clamp) socket Double A1 terminal	Panel or 35 mm rail (EN 60715) mount	<ul style="list-style-type: none"> <li>- Coil indication and EMC suppression modules</li> <li>- Jumper link</li> <li>- Timer modules</li> <li>- Metal retaining clip</li> </ul>
	90.03	60.13			



Module	Socket	Relay	Description	Mounting	Accessories
99.01	90.20	60.12	Screw terminal (Box clamp) socket	Panel or 35 mm rail (EN 60715) mount	<ul style="list-style-type: none"> <li>- Coil indication and EMC suppression modules</li> <li>- Metal retaining clip</li> </ul>
	90.21	60.13			

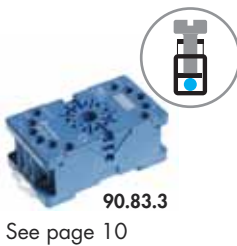

Module	Socket	Relay	Description	Mounting	Accessories
—	90.82.3	60.12	Screw terminal (Box clamp) socket	Panel or 35 mm rail (EN 60715) mount	- Metal retaining clip
—	90.83.3	60.13			



Module	Socket	Relay	Description	Mounting	Accessories
—	90.22	60.12	Screw terminal (Box clamp) socket	Panel or 35 mm rail (EN 60715) mount	- Metal retaining clip
—	90.23	60.13			

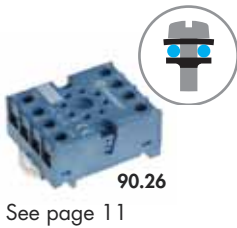

Module	Socket	Relay	Description	Mounting	Accessories
—	90.26	60.12	Screw terminal (Plate clamp) socket	Panel or 35 mm rail (EN 60715) mount	- Metal retaining clip
—	90.27	60.13			



Module	Socket	Relay	Description	Mounting	Accessories
—	90.12	60.12	Flange mount solder socket	M3 screw fixing	—
—	90.13	60.13			



Module	Socket	Relay	Description	Mounting	Accessories
—	90.14	60.12	PCB socket	PCB	—
—	90.14.1	60.12			
—	90.15	60.13			
—	90.15.1	60.13			





**90.03**  
Approvals  
(according to type):



**cUL US** Certain relay/socket combinations

Screw terminal (Box clamp) socket	90.02 Blue	90.02.0 Black	90.03 Blue	90.03.0 Black
panel or 35 mm rail (EN 60715) mount				
For relay type	60.12		60.13	
<b>Accessories</b>				
Metal retaining clip			090.33	
6-way jumper link			090.06	
Identification tag			090.00.2	
Modules (see table below)			99.02	
Timer modules (see table below)			86.00, 86.30	
<b>Technical data</b>				
Rated values	10 A - 250 V			
Dielectric strength	2 kV AC			
Protection category	IP 20			
Ambient temperature	°C -40...+70			
Ⓜ Screw torque	Nm 0.6			
Wire strip length	mm 10			
Max. wire size for 90.02 and 90.03 sockets	solid wire		stranded wire	
	mm <sup>2</sup> 1x6 / 2x2.5		1x4 / 2x2.5	
	AWG 1x10 / 2x14		1x12 / 2x14	

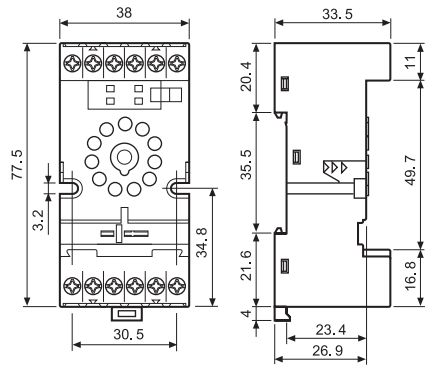
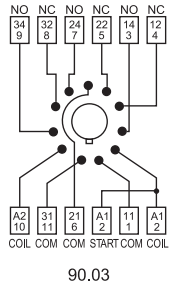
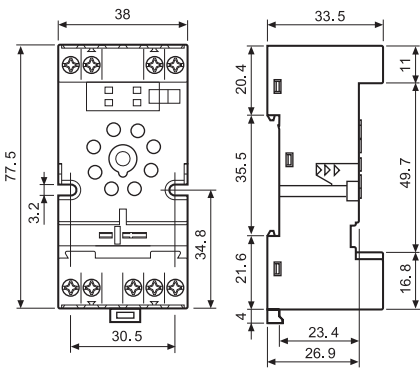
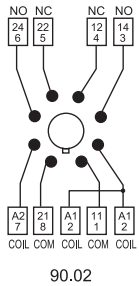

**090.06**

6-way jumper link for 90.02 and 90.03 sockets	090.06 (blue)	090.06.0 (black)
Rated values	10 A - 250 V	

Approvals (according to type):

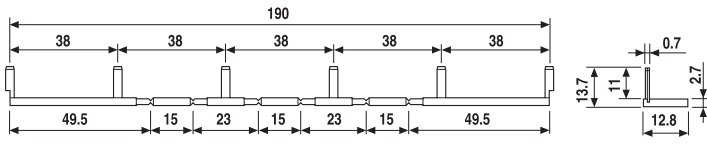

**86.00**



**86.30**

86 series timer modules		
Multi-voltage: (12...240)V AC/DC;		
Multi-functions: AI, DI, SW, BE, CE, DE, EE, FE; (0.05 s...100 h)		86.00.0.240.0000
(12...24)V AC/DC; Bi-function: AI, DI; (0.05 s...100 h)		86.30.0.024.0000
(110...125)V AC; Bi-function: AI, DI; (0.05s...100h)		86.30.8.120.0000
(230...240)V AC; Bi-function: AI, DI; (0.05 s...100 h)		86.30.8.240.0000

Approvals (according to type):



**99.02**

Approvals (according to type):



99.02 coil indication and EMC suppression modules for 90.02 and 90.03 sockets		
Diode (+A1, standard polarity)	(6...220)V DC	99.02.3.000.00
LED	(6...24)V DC/AC	99.02.0.024.59
LED	(28...60)V DC/AC	99.02.0.060.59
LED	(110...240)V DC/AC	99.02.0.230.59
LED + Diode (+A1, standard polarity)	(6...24)V DC	99.02.9.024.99
LED + Diode (+A1, standard polarity)	(28...60)V DC	99.02.9.060.99
LED + Diode (+A1, standard polarity)	(110...220)V DC	99.02.9.220.99
LED + Varistor	(6...24)V DC/AC	99.02.0.024.98
LED + Varistor	(28...60)V DC/AC	99.02.0.060.98
LED + Varistor	(110...240)V DC/AC	99.02.0.230.98
RC circuit	(6...24)V DC/AC	99.02.0.024.09
RC circuit	(28...60)V DC/AC	99.02.0.060.09
RC circuit	(110...240)V DC/AC	99.02.0.230.09
Residual current by-pass	(110...240)V AC	99.02.8.230.07

DC Modules with non-standard polarity (+A2) on request.





**90.21**

Approvals  
(according to type):



Screw terminal (Box clamp) socket	<b>90.20</b>	<b>90.20.0</b>	<b>90.21</b>	<b>90.21.0</b>
panel or 35 mm rail (EN 60715) mount	<b>Blue</b>	<b>Black</b>	<b>Blue</b>	<b>Black</b>
For relay type	60.12		60.13	
<b>Accessories</b>				
Metal retaining clip (supplied with socket - packaging code SMA)			090.33	
Modules (see table below)			99.01	
<b>Technical data</b>				
Rated values	10 A - 250 V			
Dielectric strength	2 kV AC			
Protection category	IP 20			
Ambient temperature	°C -40...+70			
⊕ Screw torque	Nm 0.5			
Wire strip length	mm 10			
Max. wire size for 90.20 and 90.21 sockets	solid wire		stranded wire	
	mm <sup>2</sup> 1x6 / 2x2.5		1x6 / 2x2.5	
	AWG 1x10 / 2x14		1x10 / 2x14	

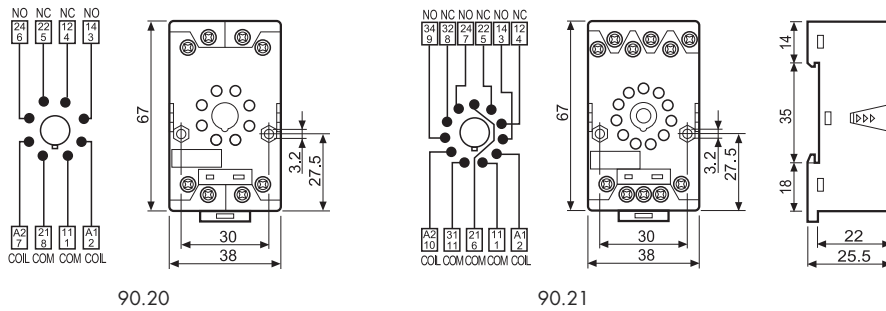

**99.01**

Approvals  
(according to type):



<b>99.01 coil indication and EMC suppression modules for 90.20 and 90.21 sockets</b>		<b>Blue*</b>
See technical data page 215/216		
Diode (+A1, standard polarity)	(6...220)V DC	99.01.3.000.00
Diode (+A2, non-standard polarity)	(6...220)V DC	99.01.2.000.00
LED	(6...24)V DC/AC	99.01.0.024.59
LED	(28...60)V DC/AC	99.01.0.060.59
LED	(110...240)V DC/AC	99.01.0.230.59
LED + Diode (+A1, standard polarity)	(6...24)V DC	99.01.9.024.99
LED + Diode (+A1, standard polarity)	(28...60)V DC	99.01.9.060.99
LED + Diode (+A1, standard polarity)	(110...220)V DC	99.01.9.220.99
LED + Diode (+A2, non-standard polarity)	(6...24)V DC	99.01.9.024.79
LED + Diode (+A2, non-standard polarity)	(28...60)V DC	99.01.9.060.79
LED + Diode (+A2, non-standard polarity)	(110...220)V DC	99.01.9.220.79
LED + Varistor	(6...24)V DC/AC	99.01.0.024.98
LED + Varistor	(28...60)V DC/AC	99.01.0.060.98
LED + Varistor	(110...240)V DC/AC	99.01.0.230.98
RC circuit	(6...24)V DC/AC	99.01.0.024.09
RC circuit	(28...60)V DC/AC	99.01.0.060.09
RC circuit	(110...240)V DC/AC	99.01.0.230.09
Residual current by-pass	(110...240)V AC	99.01.8.230.07

\* Modules in Black housing are available on request.

Green LED is standard. Red LED available on request.



90.83.3

Approvals  
(according to type):



Screw terminal (Box clamp) socket panel or 35 mm rail (EN 60715) mount	90.82.3 Blue	90.82.30 Black	90.83.3 Blue	90.83.30 Black
For relay type	60.12		60.13	
<b>Accessories</b>				
Metal retaining clip	090.33			
<b>Technical data</b>				
Rated values	10 A - 250 V			
Dielectric strength	2 kV AC			
Protection category	IP 20			
Ambient temperature	°C -40...+70			
⊕ Screw torque	Nm 0.8			
Max. wire size for 90.82.3 and 90.83.3 sockets	solid wire		stranded wire	
	mm <sup>2</sup> 1x6 / 2x4		1x6 / 2x4	
	AWG 1x10 / 2x14		1x10 / 2x14	

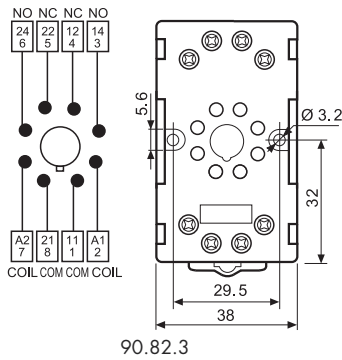

90.82.3

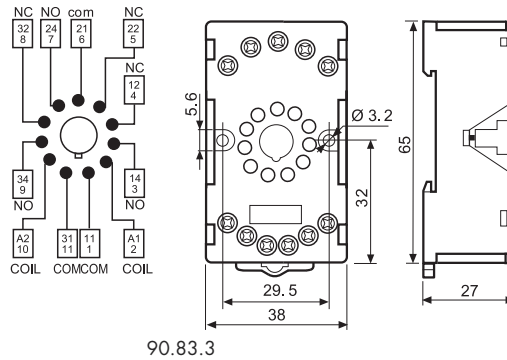

90.83.3



90.23

Approvals  
(according to type):



Screw (Box clamp) terminal socket panel or 35 mm rail (EN 60715) mount	90.22 Blue	90.23 Blue
For relay type	60.12	
<b>Accessories</b>		
Metal retaining clip (supplied with socket - packaging code SMA)	090.33	
<b>Technical data</b>		
Rated values	10 A - 250 V	
Dielectric strength	2 kV AC	
Protection category	IP 20	
Ambient temperature	°C -40...+70	
⊕ Screw torque	Nm 0.5	
Wire strip length	mm 7	
Max wire size for 90.22 and 90.23 sockets	solid wire	
	mm <sup>2</sup> 1x6 / 2x2.5	
	AWG 1x10 / 2x14	

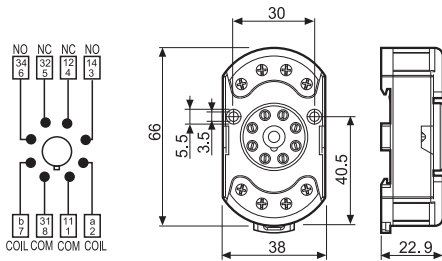

90.22

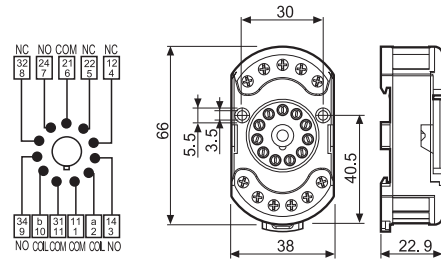

90.23

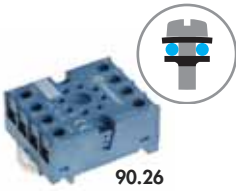

90.26

Approvals  
(according to type):



Screw terminal (Plate clamp) socket	90.26	90.26.0	90.27	90.27.0
panel or 35 mm rail (EN 60715) mount	Blue	Black	Blue	Black
For relay type	60.12		60.13	
<b>Accessories</b>				
Metal retaining clip (supplied with socket - packaging code SMA)				090.33
<b>Technical data</b>				
Rated values	10 A - 250 V			
Dielectric strength	2 kV AC			
Protection category	IP 20			
Ambient temperature	°C -40...+70			
⊕ Screw torque	Nm	0.8		
Wire strip length	mm	10		
Max. wire size for 90.26 and 90.27 sockets	solid wire			stranded wire
	mm <sup>2</sup>	1x4 / 2x2.5		1x4 / 2x2.5
	AWG	1x12 / 2x14		1x12 / 2x14

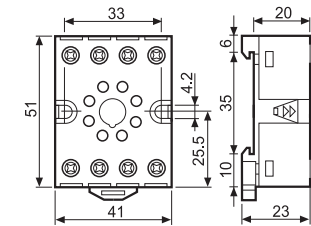

90.26

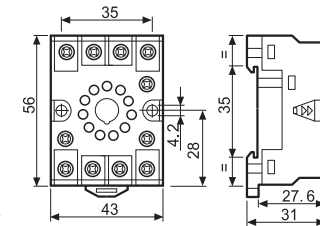
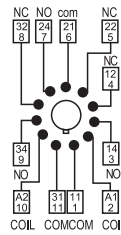

90.27



90.12

Approvals  
(according to type):



Flange mount solder socket	mount with M3 screw	90.12 (black)	90.13 (black)
For relay type		60.12	60.13
<b>Technical data</b>			
Rated values		10 A - 250 V	
Dielectric strength		2 kV AC	
Ambient temperature	°C	-40...+70	

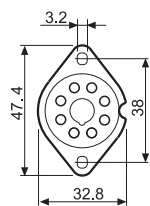

90.12

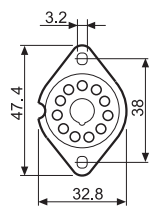

90.13

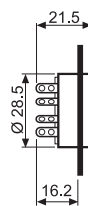



90.15

Approvals  
(according to type):



PCB socket	Blue	90.14 (Ø 20.5 mm)	90.15 (Ø 22 mm)
	Blue	90.14.1 (Ø 17.5 mm)	90.15.1 (Ø 19 mm)
For relay type		60.12	60.13
<b>Technical data</b>			
Rated values		10 A - 250 V	
Dielectric strength		2 kV AC	
Ambient temperature	°C	-40...+70	

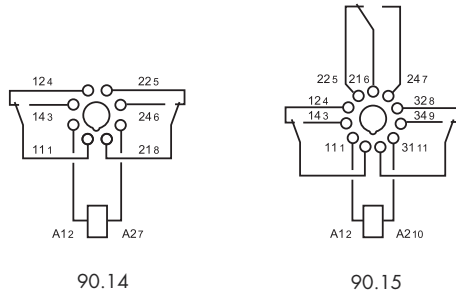
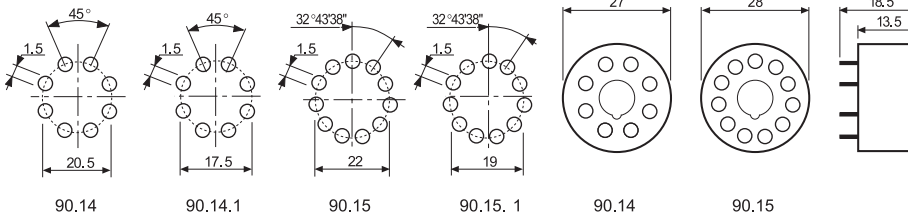

## Packaging code

How to code and identify retaining clip and packaging options for sockets.

Example:

