

WLS27 Dual Color LED Strip Light



Datasheet

Banner's WLS27 LED Strip Light has a sturdy aluminum housing and is encased in a shatterproof, UV-stabilized, copolyester shell, making it ideal for harsh indoor and outdoor applications. Having two colors in one device make these ideal for mobile vehicle, machine status, and vision lighting applications.

- Rugged, water-resistant IP69K rating
- Available in eight lengths from 145 mm to 1130 mm
- Daisy chain power to multiple lights
- Automatic temperature protection built into the unit. Above 50 °C, the light dims to manage heat and protect product lifetime



Stand-Alone Light or End Light in a Cascade—QD



First or Middle of a Cascade—QD

These Work Light Strips are available as either stand-alone models, or as cascade models that can be "daisy-chained" together for a continuous length of lighting, with a minimum of wiring.

Stand-alone models have a male quick disconnect (QD) at one end for power connection and no connections at opposite end. A stand-alone model may be used as the last in the cascade series.

Cascade models have a male quick disconnect (QD) at one end for power connection, and a female QD at the opposite end for connecting to other lights in the cascade. A double-ended accessory cordset must be used between each pair of lights in a cascade.

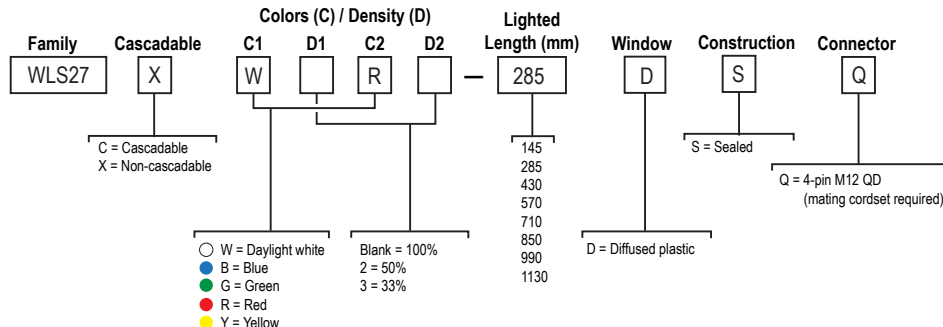

Density (D) is defined by the quantity of LEDs populated on the circuit. For example, at 100% density, there are 18 LEDs per 285 mm, and at 50% density, there are 9 LEDs per 285 mm. The lumen output decreases proportionally with density.

Sample Model Number	Description
WLS27XWR-285DSQ	Non Cascade, White (100% Density), Red (100% Density), 285 mm, 4-pin M12 quick disconnect connector
WLS27CWR-850DSQ	Cascadable, White (100% Density), Red (100% Density), 850 mm, 4-pin M12 quick disconnect connector
WLS27XWR2-285DSQ	Non-Cascade, White (100% Density), Red (50% Density), 285 mm, 4-pin M12 quick disconnect connector



Specifications

Supply Voltage

12 to 30 V dc

Use only with suitable Class 2 power supply (UL) or a SELV power supply (CE).

Light Length (mm)	Typical Current (A)			Max. Current A
	12 V dc	24 V dc	30 V dc	
145	0.33	0.15	0.12	0.4
285	0.66	0.30	0.24	0.8
430	1.01	0.46	0.36	1.2
570	1.36	0.61	0.48	1.6
710	1.75	0.77	0.60	2.0
850	2.13	0.92	0.73	2.4
990	2.59	1.08	0.85	2.8
1130	3.04	1.24	0.97	3.2

Light Characteristics - Other Colors

Color	Typical Wavelength or Color Temperature	Typical Intensity (per 285 mm)
Red	625 nm	200
Yellow	590 nm	150
Green	525 nm	300
Blue	470 nm	110

Mounting

Bracket LMBWLS27EC included (2 for lights up to 570 mm or 3 for lights 710 mm and longer)

Construction

Copolyester outer housing

Connections

Integral 4-pin M12 male quick disconnect (QD) (4-pin connecting cordset required)

Light Characteristics - Daylight White

Color Temperature (CCT): 4700-5300K

Lumen output: 475 (± 5%) per 285 mm, typical at 25 °C (77 °F)

CRI: 83, typical

Application Notes

When connecting cascadable lights in series it is important not to exceed maximum current limitations:

Maximum length of light at 12 V dc: 1.4 m (4.6 ft)

Maximum length of light at 24 V dc: 3.0 m (9.8 ft)

Maximum length of light at 30 V dc: 3.1 m (10.2 ft)

Certifications



NOTE: Do not spray cable with high-pressure sprayer, or cable damage will result.

Environmental Rating

Rated IEC IP66, IP67, and IP69K, per DIN 40050

Vibration and Mechanical Shock

Vibration 10-55 Hz 1.0 mm p-p amplitude per IEC 60068-2-6

Shock 15G 11 ms duration, half sine wave per IEC 60068-2-27

Operating Temperature

-40 °C to +70 °C (-40 °F to +158 °F)

Light output begins to decrease above 50 °C (122 °F) and will be approximately 65% of max intensity at 60 °C (140 °F) and 30% of max intensity at 70 °C (158 °F)

Storage Temperature

-40 °C to +70 °C (-40 °F to +158 °F)

Performance

145 mm Models

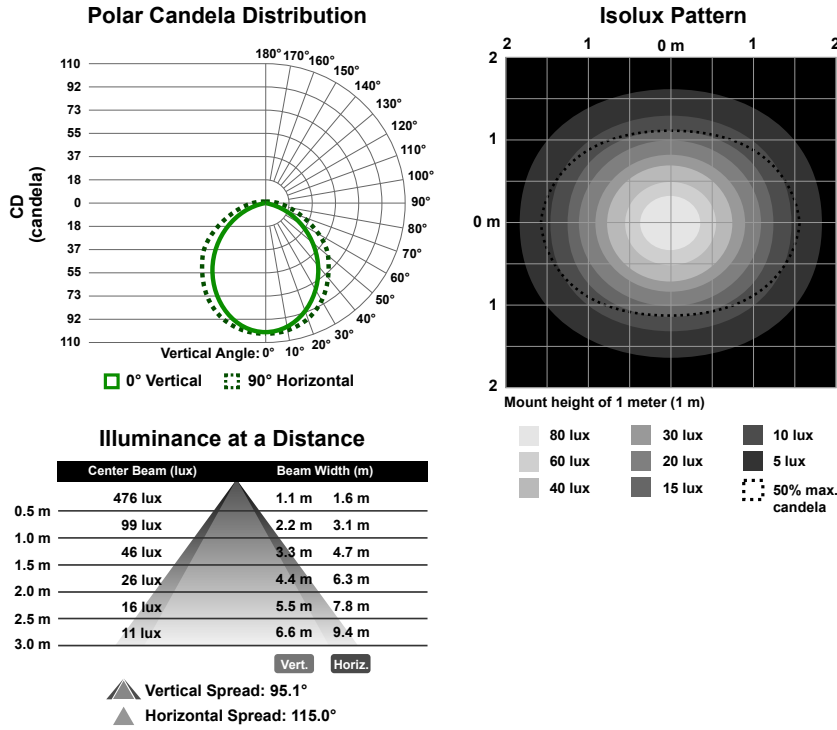

285 mm Models

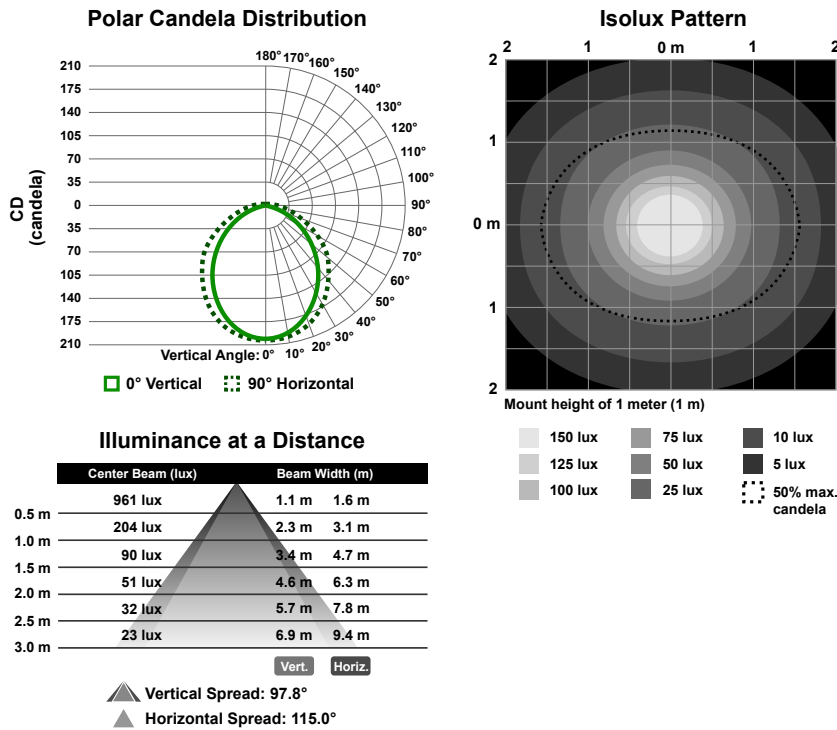

430 mm Models

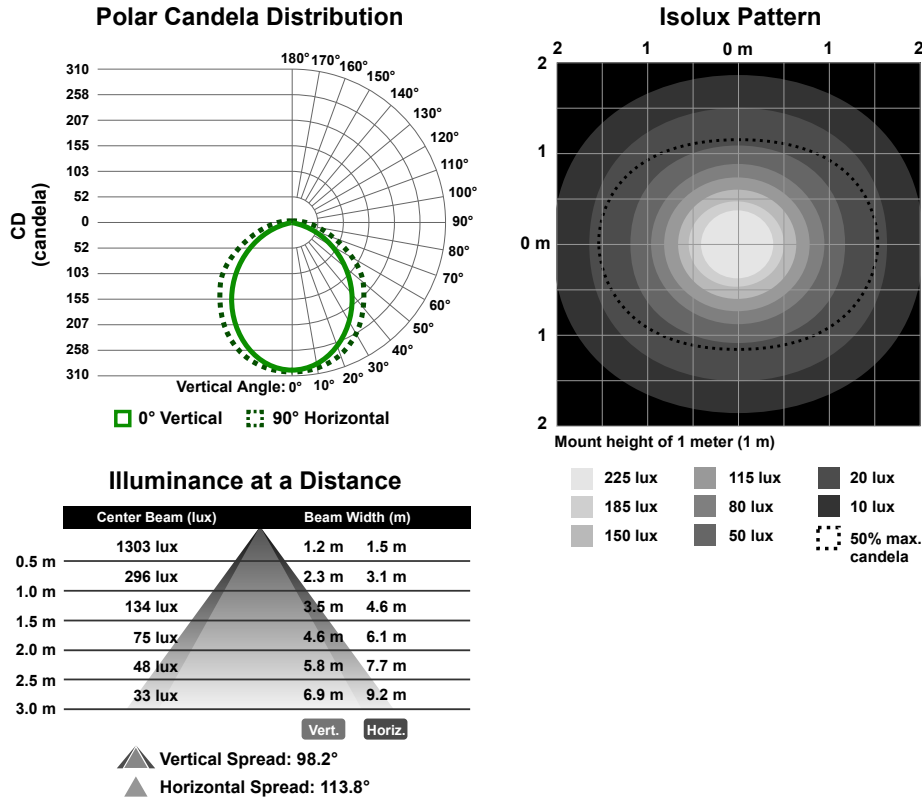

570 mm Models

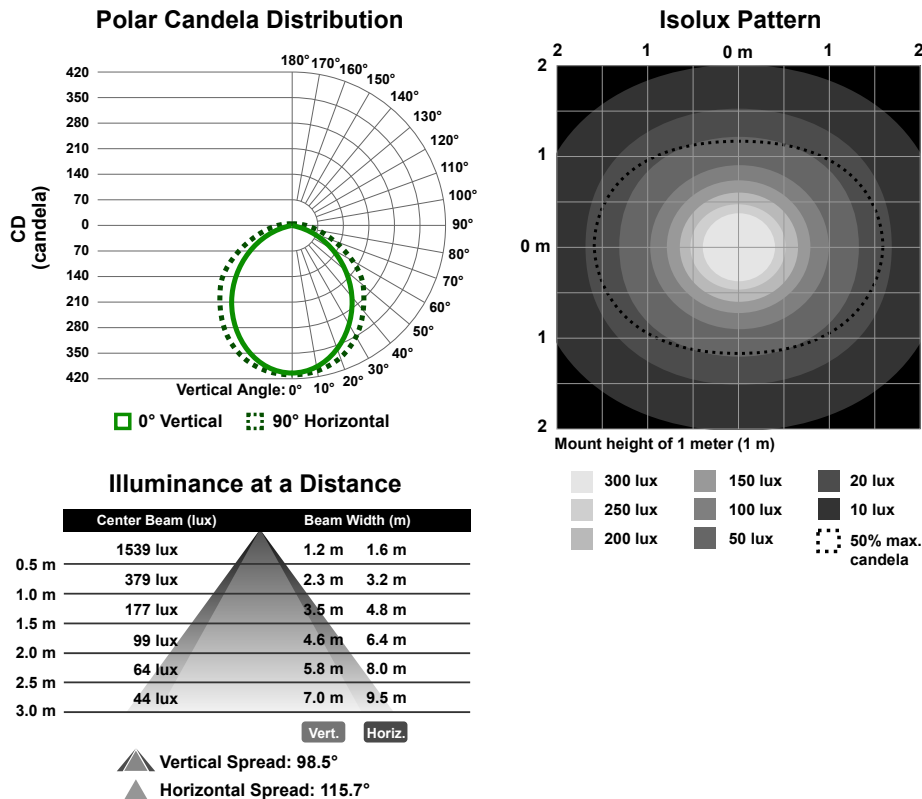

710 mm Models

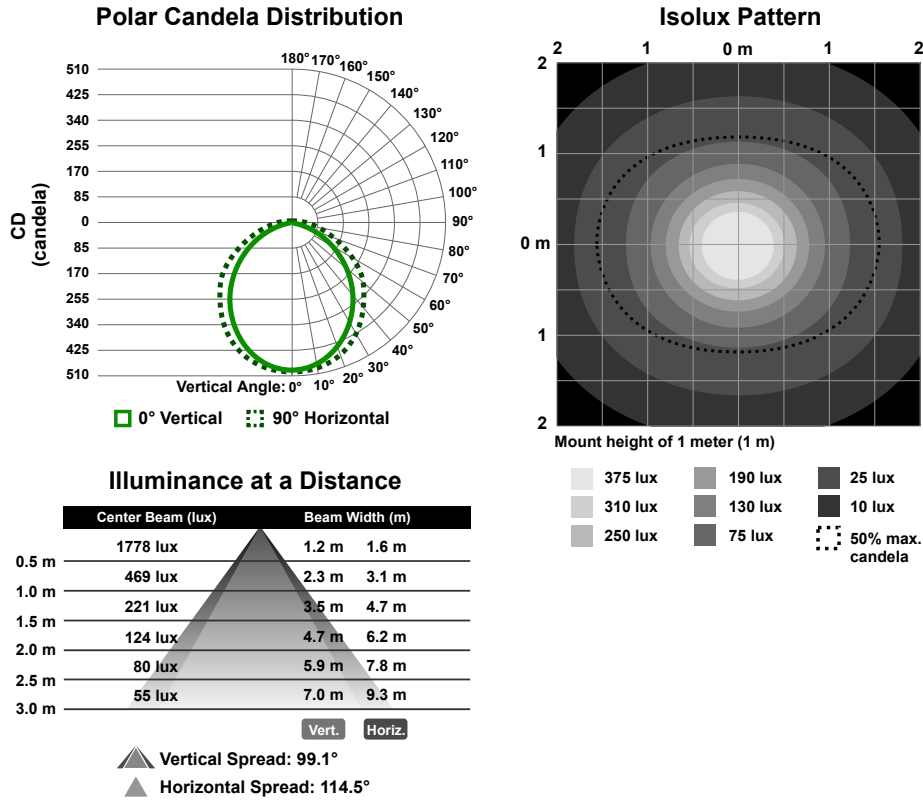

850 mm Models

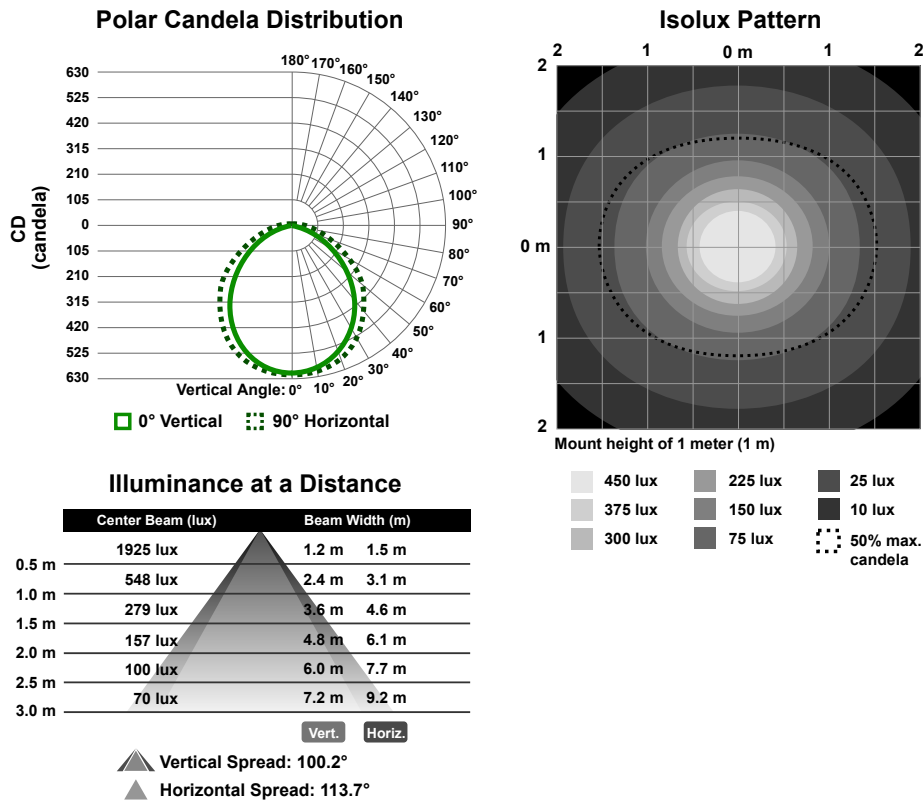

990 mm Models

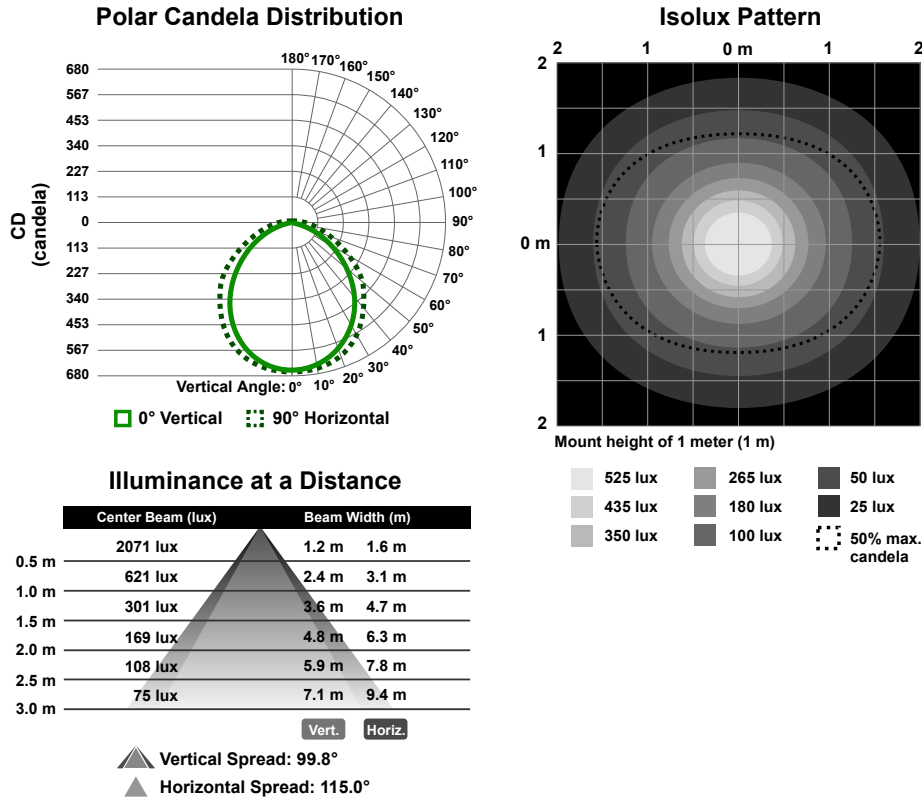

1130 mm Models

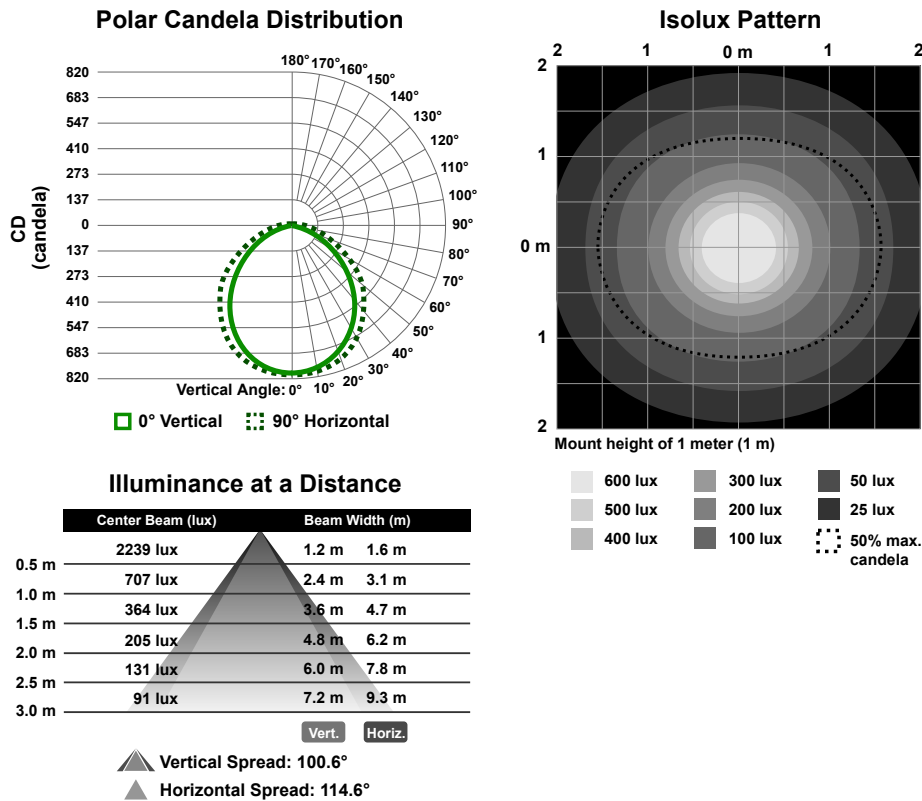

Dimensions

Quick Disconnect Models

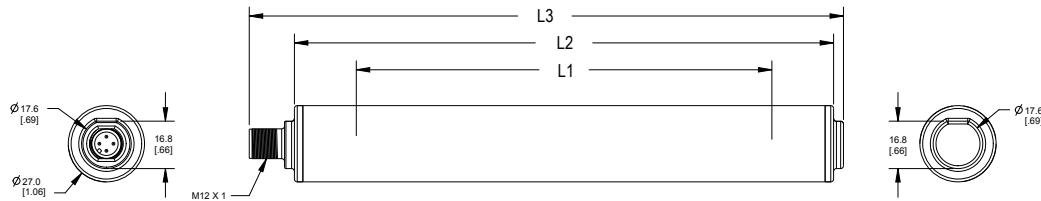

Cascade Models

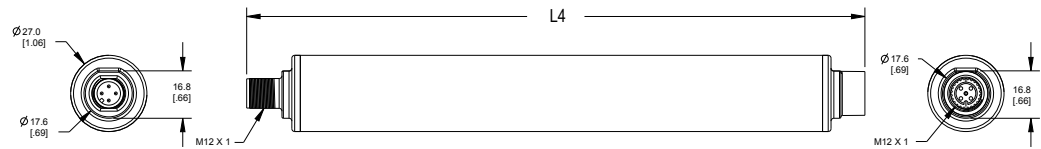

Models	L1	L2	L3	L4
WLS27..145..	145 mm (5.7 in)	189 mm (7.4 in)	208.5 mm (8.2 in)	217 mm (8.5 in)
WLS27..285..	286 mm (11.3 in)	330 (13 in)	349.5 mm (13.8 in)	358 mm (14.1 in)
WLS27..430..	427 mm (16.8 in)	471 mm (18.5 in)	490.5 mm (13.3 in)	499 mm (19.6 in)
WLS27..570..	569 mm (22.4 in)	612 mm (24.1 in)	631.5 mm (24.9 in)	640 mm (25.2 in)
WLS27..710..	708 mm (27.9 in)	752 mm (29.6 in)	771.5 mm (30.4 in)	780 mm (30.7 in)
WLS27..850..	849 mm (33.4 in)	893 mm (35.2 in)	912.5 mm (35.9 in)	921 mm (36.2 in)
WLS27..990..	991 mm (39 in)	1035 mm (40.8 in)	1054.5 mm (41.5 in)	1063 mm (41.8 in)
WLS27..1130..	1120 mm (44.1 in)	1164 mm (45.8 in)	1183.5 mm (46.4 in)	1192 mm (46.9 in)

Wiring Diagram

Male	Female	Pin	Wire Color	Connection
		1	brown	Color 1: 12 to 30 V dc
		3	blue	dc common
		4	black	Color 2: 12 to 30 V dc (color 2 overrides color 1)
		2	white	Not used

Accessories

Cordsets

Use single-ended cordsets between the power source and the QD connection of a stand-alone light or the first light in a cascade. Use double-ended cordsets between lights in a cascade.

4-Pin Threaded M12/Euro-Style Cordsets				
Model	Length	Style	Dimensions	Pinout (Female)
MQDC-406	1.83 m (6 ft)	Straight		
MQDC-415	4.57 m (15 ft)			
MQDC-430	9.14 m (30 ft)			
MQDC-450	15.2 m (50 ft)			
MQDC-406RA	1.83 m (6 ft)	Right-Angle		<p>1 = Brown 2 = White 3 = Blue 4 = Black</p>
MQDC-415RA	4.57 m (15 ft)			
MQDC-430RA	9.14 m (30 ft)			
MQDC-450RA	15.2 m (50 ft)			

4-Pin Threaded M12/Euro-Style Cordsets—Double Ended				
Model	Length	Style	Dimensions	Pinout
MQDEC-401SS	0.31 m (1 ft)	Male Straight/ Female Straight		Female
MQDEC-403SS	0.91 m (3 ft)			
MQDEC-406SS	1.83 m (6 ft)			Male
MQDEC-412SS	3.66 m (12 ft)			
MQDEC-420SS	6.10 m (20 ft)			<p>1 = Brown 2 = White 3 = Blue 4 = Black</p>
MQDEC-430SS	9.14 m (30 ft)			
MQDEC-450SS	15.2 m (50 ft)			

4-Pin Threaded M12/Euro-Style Cordsets—Washdown, Stainless Steel				
Model	Length	Style	Dimensions	Pinout (Female)
MQDC-WDSS-0406	1.83 m (6 ft)	Straight		
MQDC-WDSS-0415	4.57 m (15 ft)			
MQDC-WDSS-0430	9.14 m (30 ft)			
				<p>1 = Brown 2 = White 3 = Blue 4 = Black</p>

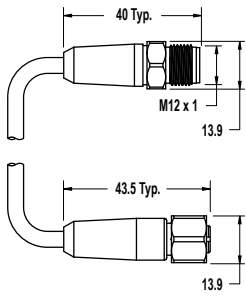
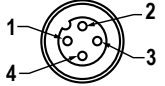
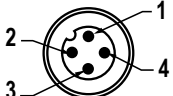
4-Pin Threaded M12/Euro-Style Cordsets—Double Ended, Washdown, Stainless Steel				
Model	Length	Style	Dimensions	Pinout
MQDEC-WDSS-401SS	0.3 m (1 ft)	Male Straight/ Female Straight		Female
MQDEC-WDSS-403SS	0.91 m (3 ft)			
MQDEC-WDSS-406SS	1.83 m (6 ft)			Male
MQDEC-WDSS-412SS	3.66 m (12 ft)			 <p>1 = Brown 2 = White 3 = Blue 4 = Black</p>

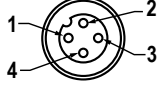
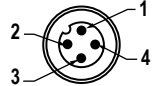
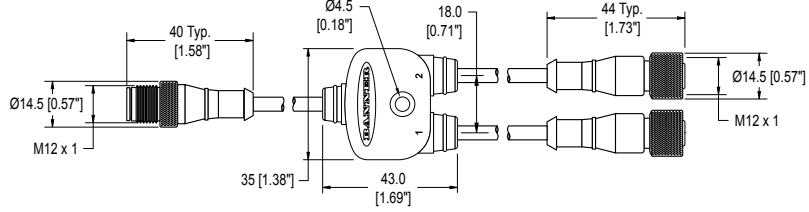
4-Pin Threaded M12/Euro-Style Splitter Cordsets—Flat Junction			
Model	Branches (Female)	Trunk (Male)	Pinout
CSB-M1240M1240	No branch	No trunk	<p>Female</p>  <p>Male</p>  <p>1 = Brown 2 = White 3 = Blue 4 = Black</p>
CSB-M1240M1241	2 x 0.30 m (1 ft)	No trunk	
CSB-M1241M1241		0.30 m (1 ft)	
CSB-M1248M1241		2.50 m (8 ft)	
CSB-M12415M1241		4.57 m (15 ft)	
CSB-M12425M1241		7.60 m (25 ft)	
CSB-UNT425M1241		7.60 m (25 ft) Unterminated	
			

Brackets

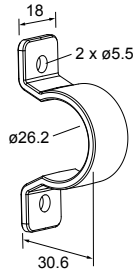
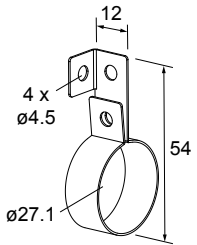
<p>LMBWLS27EC</p> <ul style="list-style-type: none"> • Clear copolyester • Clearance for M5 or #10 hardware 	<p>LMBWLS27H</p> <ul style="list-style-type: none"> • Stainless steel mounting brackets • M4 stainless steel hardware included 
---	--

LMBWLS27SP

- Clear copolyester
- Clearance for M5 or #10 hardware
- Snap bracket for light duty applications

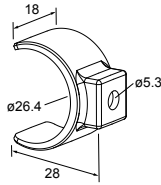

LMBWLS27U

- Clear copolyester
- Clearance for M5 or #10 hardware
- Clamps securely around the light body

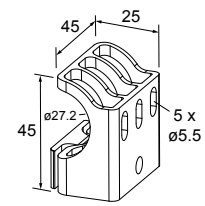

Banner Engineering Corp. Limited Warranty

Banner Engineering Corp. warrants its products to be free from defects in material and workmanship for one year following the date of shipment. Banner Engineering Corp. will repair or replace, free of charge, any product of its manufacture which, at the time it is returned to the factory, is found to have been defective during the warranty period. This warranty does not cover damage or liability for misuse, abuse, or the improper application or installation of the Banner product.

THIS LIMITED WARRANTY IS EXCLUSIVE AND IN LIEU OF ALL OTHER WARRANTIES WHETHER EXPRESS OR IMPLIED (INCLUDING, WITHOUT LIMITATION, ANY WARRANTY OF MERCHANTABILITY OR FITNESS FOR A PARTICULAR PURPOSE), AND WHETHER ARISING UNDER COURSE OF PERFORMANCE, COURSE OF DEALING OR TRADE USAGE.

This Warranty is exclusive and limited to repair or, at the discretion of Banner Engineering Corp., replacement. IN NO EVENT SHALL BANNER ENGINEERING CORP. BE LIABLE TO BUYER OR ANY OTHER PERSON OR ENTITY FOR ANY EXTRA COSTS, EXPENSES, LOSSES, LOSS OF PROFITS, OR ANY INCIDENTAL, CONSEQUENTIAL OR SPECIAL DAMAGES RESULTING FROM ANY PRODUCT DEFECT OR FROM THE USE OR INABILITY TO USE THE PRODUCT, WHETHER ARISING IN CONTRACT OR WARRANTY, STATUTE, TORT, STRICT LIABILITY, NEGLIGENCE, OR OTHERWISE.

Banner Engineering Corp. reserves the right to change, modify or improve the design of the product without assuming any obligations or liabilities relating to any product previously manufactured by Banner Engineering Corp. Any misuse, abuse, or improper application or installation of this product or use of the product for personal protection applications when the product is identified as not intended for such purposes will void the product warranty. Any modifications to this product without prior express approval by Banner Engineering Corp will void the product warranties. All specifications published in this document are subject to change; Banner reserves the right to modify product specifications or update documentation at any time. Specifications and product information in English supersede that which is provided in any other language. For the most recent version of any documentation, refer to: www.bannerengineering.com.