



EFit **User Guide**

Power Controller

HA031980ENG issue 1
February 2014

Restriction of Hazardous Substances (RoHS)

Product group

EFit

Table listing restricted substances

Chinese

| 限制使用材料一览表 | | | | | | |
|-----------|---|---|---|-----|------|-------|
| 产品 | 有毒有害物质或元素 | | | | | |
| EFit | 铅 | 汞 | 镉 | 六价铬 | 多溴联苯 | 多溴二苯醚 |
| 功率模块 16安培 | X | X | O | O | O | O |
| 功率模块 25安培 | X | X | O | O | O | O |
| 功率模块 40安培 | X | X | O | O | O | O |
| 功率模块 50安培 | X | X | O | O | O | O |
| O | 表示该有毒有害物质在该部件所有均质材料中的含量均在SJ/T11363-2006 标准规定的限量要求以下。 | | | | | |
| X | 表示该有毒有害物质至少在该部件的某一均质材料中的含量超出SJ/T11363-2006 标准规定的限量要求。 | | | | | |

English

| Restricted Materials Table | | | | | | |
|---|--|----|----|--------|-----|------|
| Toxic and hazardous substances and elements | | | | | | |
| Product | Pb | Hg | Cd | Cr(VI) | PBB | PBDE |
| EFit | | | | | | |
| Power Module 16A | X | X | O | O | O | O |
| Power Module 25A | X | X | O | O | O | O |
| Power Module 40A | X | X | O | O | O | O |
| Power Module 50A | X | X | O | O | O | O |
| O | Indicates that this toxic or hazardous substance contained in all of the homogeneous materials for this part is below the limit requirement in SJ/T11363-2006. | | | | | |
| X | Indicates that this toxic or hazardous substance contained in at least one of the homogeneous materials used for this part is above the limit requirement in SJ/T11363-2006. | | | | | |

Approval

| Name: | Position: | Signature: | Date: |
|------------|--------------|--------------|--------------------|
| Kevin Shaw | R&D Director | <i>KShaw</i> | 27th February 2014 |

Thyristor power controllers

EFit Series

For the control of heating elements up to 25 Kw

User Manual

Before installation, please read this manual thoroughly.

Eurotherm cannot be held responsible for any damage to persons or property, or for any financial loss or costs arising from incorrect use of the product or failure to observe the instructions given in this manual.

In order to maintain its 'leading edge' Eurotherm may have to make changes to its specifications without advance notice.

For any further information, or if in doubt, please contact Invensys Eurotherm, where qualified staff are available to advise or assist you with the commissioning of your installation.

Guarantee

Two years parts and labour guarantee

Contents List

| | |
|---|----|
| 1. Safety notes | 1 |
| 1.1 Warnings | 1 |
| 1.2 SELV | 4 |
| 1.3 Symbols used on the instrument labeling | 4 |
| 2. Technical specifications | 5 |
| 3. Codification | 8 |
| 3.1 Ordering code | 8 |
| 3.2 Fuses | 9 |
| 4. Mechanical installation | 10 |
| 4.1 Dimensional details | 10 |
| 4.2 Front fascia | 11 |
| 5. Electrical Installation | 12 |
| 5.1 Terminals and connectors | 12 |
| 5.2 Connector view | 13 |
| 5.2.1 View on lower face | 13 |
| 5.2.2 View on upper face | 13 |
| 6. Control wiring | 14 |
| 6.1 Input signal wiring | 14 |
| 6.1.1 Remote Control | 14 |
| 6.1.2 Local control by potentiometer | 15 |
| 6.1.3 Local control by contacts | 15 |
| 6.2 Auxiliary power supply (option) | 16 |
| 7. Current limit option | 17 |
| 7.1 Operations | 17 |
| 7.2 Adjustment | 17 |

| | |
|---|----|
| 8. Thyristors firing modes | 18 |
| 8.1 Fast cycle | 18 |
| 8.2 Single-cycle | 19 |
| 8.3 Advanced Single-cycle | 20 |
| 8.4 Phase angle | 21 |
| 9. Power control | 22 |
| 9.1 Description | 22 |
| 9.2 Compensation of power supply fluctuations | 22 |
| 10. Current derating | 23 |

1. SAFETY NOTES

1.1 WARNING

BRANCH-CIRCUIT PROTECTION AND SAFETY OVERLOAD PROTECTION

This product does not contain any branch-circuit protection or internal safety overload protection. It is the responsibility of the user to add branch-circuit protection upstream of the unit. It is also the responsibility of the user to provide external or remote safety overload protection to the end installation.

Such branch-circuit and safety overload protection must comply with applicable local regulations.

UL: The above mentioned branch-circuit protection is necessary for compliance with National Electric Code (NEC) requirements. If opening of the branch circuit protective or the supplemental fuses (high speed fuse) EFit shall be examined and replaced if damaged.

It is strongly recommended that the installing authority includes independent, system-safety mechanisms to protect both personnel and equipment against injury or damage, and that such safety mechanisms be regularly inspected and maintained. Consult the EFit supplier for advice.

The instrument shall have one of the following as a disconnecting device, fitted within easy reach of the operator, and labelled as the disconnecting device.

- a. A branch-circuit protection (circuit breaker or fuse which complies with the requirements of IEC60947-1).
- b. A separable coupler which can be disconnected without the use of a tool.

1. Any interruption of the protective conductor outside the equipment, or disconnection of the protective earth terminal is likely to make the device dangerous under some fault conditions. Intentional interruption is prohibited.
2. Before carrying out any wiring to the unit it must be ensured that all relevant power and control cables, leads or harnesses are isolated from voltage sources. Wire conductor cross sections must comply with table 9 of IEC60947-1 (or NEC, Article 310 Table 310-16).
3. This equipment is not suitable for isolation applications, within the meaning of IEC60947-1.
4. The heatsink becomes hot whilst the unit is running, and it can take up to 15 minutes to cool after the unit is shut down. The heatsink temperature may rise above 50 degrees Celsius. If operators are likely to come into contact with such heatsinks, adequate warnings and barriers must be put in place in order to prevent injury.

Before any other connection is made, the protective earth terminal shall be connected to a protective conductor by a listed ring crimp. Whenever it is likely that protection has been impaired, the unit shall be made inoperative, and secured against accidental operation. The manufacturer's nearest service centre should be contacted for advice.

Any adjustment, maintenance and repair of the opened apparatus under voltage, is forbidden for safety reasons.

Units are designed to be installed in a cabinet connected to the protective earth according to IEC60364-1 and IEC60364-5-54 or applicable national standards. The cabinet must be closed under normal operating conditions. Adequate air conditioning/ filtering/ cooling equipment must be fitted to the cabinet in order to prevent the ingress of conductive pollution, the formation of condensation etc.









5. Units are designed to be mounted vertically. There must be no obstructions (above or below) which could reduce or hamper airflow. If more than one set of units is located in the same cabinet, they must be mounted in such a way that air from one unit is not drawn into another.
6. Signal and power voltage wiring must be kept separate from one another. Where this is impractical, shielded cables should be used for the signal wiring.
7. If the equipment is used in a manner not specified by the manufacturer, the protection provided by the equipment might be impaired.
8. This product has been designed for environment A (Industrial). Use of this product in environment B (domestic, commercial and light industrial) may cause unwanted electromagnetic disturbances in which cases the user may be required to take adequate mitigation measures.

1.2 SELV

Safety Extra Low Voltage. This is defined (in IEC60947-1) as an electrical circuit in which the voltage cannot exceed 'ELV' under normal conditions or under single fault conditions, including earth faults in other circuits. The definition of ELV is complex as it depends on environment, signal frequency etc. See IEC 61140 for further details. The input connector (pin 5 to 7) is compliant to the SELV requirements.

1.3 SYMBOLS USED IN THE INSTRUMENT LABELING

One or more of the symbols below may appear as a part of the instrument labeling.

| | | | |
|---|---|---|---|
|  | Protective conductor terminal |  | Risk of electric shock |
|  | AC supply only |  | Precautions against static electrical discharge must be taken when handling this unit |
|  | Underwriters Laboratories listed mark for Canada and the US |  | Refer to the manual for instructions |
|  | Do not touch Heatsink Hot Surface |  | Declaration of conformity to European standard |

2. Technical specifications

| General | | | | | |
|------------------------------------|---|-------|------------------------------|-----------------------|-----|
| Directive | EMC directive 2004/108/EC Low Voltage Directive 2006/95/EC | | | | |
| Safety specification | EN 60947-4-3:2000 (2000-01-12) + EN 60947-4-3:2000/A1:2006 (2006-12-08) + EN 60947-4-3:2000/A2:2011 (2011-09-02) | | | | |
| EMC emissions specification | EN 60947-4-3:2000 (2000-01-12) + EN 60947-4-3:2000/A1:2006 (2006-12-08) + EN 60947-4-3:2000/A2:2011 (2011-09-02) Class A product | | | | |
| EMC immunity specification | EN 60947-4-3:2000 (2000-01-12) EN 60947-4-3:2000/A1:2006 (2006-12-08) EN 60947-4-3:2000/A2:2011 (2011-09-02) | | | | |
| Vibration tests | EN60947-1 annex Q category E | | | | |
| Shock tests | EN60947-1 annex Q category E | | | | |
| Approvals | | | | | |
| cUL | UL60947-4-1A and UL60947-1 | | | | |
| CE | EN60947-4-3 and EN 60947-1 A certificate of conformity can be provided on simple request | | | | |
| CCC (China Compulsory Certificate) | Product not listed in catalogue of Products Subject to Compulsory Certification | | | | |
| Protection | IP20 According to EN60529 - CE, Open type - UL | | | | |
| Installation Category | | | | | |
| | Rated impulse withstand voltage (U imp) | | Rated insulated voltage (Ui) | Installation Category | |
| | CE | UL | | CE | UL |
| Control | 0,5kV | 0,8kV | 50V | II | III |
| Auxiliary Supply | 2,5kV | 4kV | 230V | II | III |
| Power terminals | 4kV | 6kV | 500V | II | III |

| Condition of use | |
|---|--|
| Atmosphere | Non-corrosive, non-explosive, non-conductive |
| Usage temperature | 0 to 45°C without derating |
| Storage temperature | -25°C to 70°C (maximum) |
| Altitude | 1000m maximum at 45 °C 2000 m maximum at 40°C |
| Degree of pollution | Degree 2 |
| Humidity limits | 5% to 95% RH (non-condensing) |
| Mechanical Details | |
| Dimensions | |
| Model 16 amps | 115 mm (Height) x 52.5 mm (Width) x 92.5 mm (Depth) |
| Model 25 amps | 115 mm (Height) x 70 mm (Width) x 92.5 mm (Depth) |
| Model 40 amps | 115 mm (Height) x 105 mm (Width) x 92.5 mm (Depth) |
| Model 50 amps | 115 mm (Height) x 122.5 mm (Width) x 92.5 mm (Depth) |
| Mounting | DIN rail |
| Power | |
| Nominal current | 16 to 50 A |
| Nominal voltage | 100V to 500V (+10%/-15%). Refer to 'Codification' for more details |
| Frequency | 47Hz to 63Hz |
| Rated short-circuit conditional current | 100KA (coordination type 1) (see 3.2) |
| Type of loads | |
| AC51 | Pure resistive |
| AC-56a | Transformer Primary (Phase Angle product only with current limit) |

| Control | |
|---|--|
| Supply of electronics | Self powered product: 100Vac to 500Vac Auxiliary supply: 115Vac or 230Vac. Auxiliary supply must be in phase with the line. The control circuit shall be protected by a ATM2 fuse rated 600Vac/dc, 2A, 100kA |
| Control setpoint | Either analogue (analogue input or potentiometer) or logic |
| <ul style="list-style-type: none"> Analogue input signal | DC voltage : 0-5V, 0-10V, Input impedance 100k ohms DC current : 4-20mA Burden resistor 250 ohms |
| <ul style="list-style-type: none"> Potentiometer | A '5V user' voltage is available between terminals 5 and 7 to be used with an external potentiometer of 10Kohm. One potentiometer per unit should be used |
| <ul style="list-style-type: none"> Logic | Contact for On/Off logic operation |
| Control Performance | |
| Linearity | Better than $\pm 2\%$ of the full range |
| Stability | Better than $\pm 2\%$ of the full range with constant resistance Automatic compensation for supply fluctuation (variation: between -10% and +10% of the nominal voltage). |
| Firing modes | Burst - Burst variable (16 periods) - Single cycle - Advanced single cycle Phase angle - With or Without current limit |

3. Codification

Ordering Code

Model /Current/Voltage/Input /Firing /Manual language/Supply
Current limit /Fuse/00

| Model | |
|-----------------|-------|
| EFit | EFIT |
| Nominal Current | |
| 16 amps | 16A |
| 25 amps | 25A |
| 40 amps | 40A |
| 50 amps | 50A |
| Nominal Voltage | |
| 100 volts | 100V |
| 115 volts | 115V |
| 200 volts | 200V |
| 230 volts | 230V |
| 240 volts | 240V |
| 277 volts | 277V |
| 380 volts | 380V |
| 400 volts | 400V |
| 415 volts | 415V |
| 440 volts | 440V |
| 480 volts | 480V |
| 500 volts | 500V |
| Input | |
| 0-5Vdc | 0V5 |
| 4-20mA | 4mA20 |
| 0-10V | 0V10 |

⁽¹⁾ See 3.2

| Firing mode | |
|--------------------------------------|--------|
| Burst Variable | FC |
| Single cycle | FC1 |
| Advanced single cycle | SCA |
| Phase angle | PA |
| Language | |
| English | ENG |
| French | FRA |
| German | GER |
| Supply | |
| Self-powered | SELF |
| Aux power supply 115 volts | 115V |
| Aux power supply 230 volts | 230V |
| Current limit | |
| Without current limit | XX |
| With current limit (only with PA) | CL |
| Fuse | |
| Without fuse ⁽¹⁾ | NOFUSE |
| With fuse without microswitch | FUSE |
| With fuse with microswitch | MSFUSE |

3.2 Fuses

According to the CE and UL certifications, high speed fuses are necessary for the protection of the EFit power controller against short circuit.

The power circuit shall be protected by a supplemental fuse as described in the table below. These should be used in conjunction with suitable fuse holders and contact kits (if required) as shown in this table.

With supplemental fuse (high speed fuse), EFit is suitable for use on a circuit capable of delivering not more than 100kA rms symmetrical amperes, 500 Volts Maximum. (coordination Type 1)

Warning : if opening of the branch circuit protective or the supplemental fuse (high speed fuse) EFit shall be examined and replaced if damaged.

| | | Fuse body size (mm) | Fuse holder part no. | Fuse part no. | Contact kit part no. |
|-----|---------|---------------------|----------------------|---------------|----------------------|
| 16A | w/o MS | 10x38 | CP018525 | CS031505U002 | |
| | with MS | 14x51 | CP171480 | CS031506U002 | CP177220 |
| 25A | w/o MS | 10x38 | CP018525 | CS031505U002 | |
| | with MS | 14x51 | CP171480 | CS031506U002 | CP177220 |
| 40A | w/o MS | 14x51 | CP171480 | CS031509U002 | |
| | with MS | 14x51 | CP171480 | CS031510U002 | CP177220 |
| 50A | w/o MS | 22x58 | CP173083 | CS031511U002 | |
| | with MS | 22x58 | CP173083 | CS031512U002 | CP177221 |

4. Mechanical installation

4.1 Dimensional details

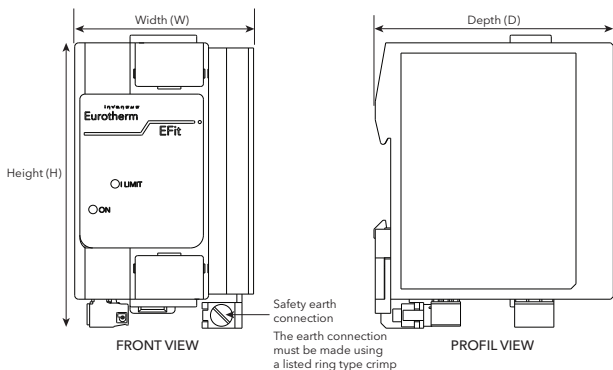

| Model | Height (mm) | Width (mm) | Depth (mm) |
|-------|-------------|------------|------------|
| 16A | 115 | 52,5 | 92,5 |
| 25A | 115 | 70 | 92,5 |
| 40A | 115 | 105 | 92,5 |
| 50A | 115 | 122,5 | 92,5 |

Minimum spacing (width) between two EFit units:

- 10mm up to 45°C (ambient temperature)

Safety earth: For EMC compliance ensure that the DIN rail is electrically bonded to the reference ground (panel or bulkhead)

4.2 Front fascia

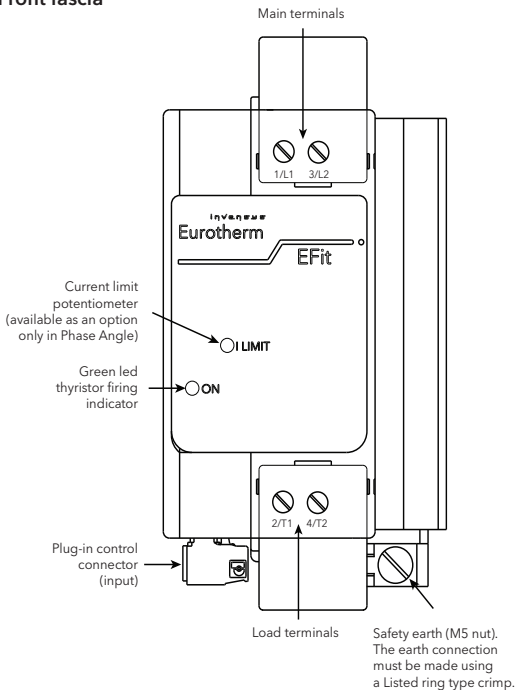

FRONT FASCIA

5. Electrical Installation

5.1 Terminals and connectors

Tables below, give details of wire sizes and tightening torques for both power supply and signal wiring connection. Where a range of wire sizes is given it is up to the user to select the correct cross sectional area required for the application. The safety earth cable should be, as a minimum, of the same cross sectional area as the cables used for the load (i.e. the cables terminated at the 1/L1, 3/L2, 2/T1 and 4/T2 terminals. "The earth connection must be made using a listed ring type crimp."

POWER TERMINALS

| Terminal | Function | Terminal type | Cable | Stripping | Tightening torque | Screw driver details |
|---|------------------------------|---------------|--|--|---------------------|----------------------|
| 1/L1 | Mains - Controlled phase | Cage | 1.5mm ² to 16mm ² (14 to 6 AWG) rated 90°C | 16mm | 2.3N.m (20.4 Lb.In) | 1x5,5mm |
| 3/L2 | Mains - Direct phase/Neutral | | | | | |
| 2/T1 | Load - Controlled phase | | | | | |
| 4/T2 | Load - Direct phase/Neutral | | | | | |
|  | Safety earth | M5 screw | Same section as power minimum rated 90°C | The earth connection must be made using a listed ring type crimp | | |

CONTROL BOARD CONNECTORS

| Terminal | Function | Connector type | Cable | Stripping | Tightening torque | Screw driver details |
|----------|---------------------------------|----------------|---|-----------|----------------------|----------------------|
| 5 | 0V of control signal | Plug-in | 0.5 to 2.5mm ² (24 to 12 AWG) rated 75°C | 7mm | 0.6N.m (5.31 Lb.In) | 0,6 x3,5mm |
| 6 | '+' of control signal | | | | | |
| 7 | User 5V | | | | | |
| 8 & 10 | Auxiliary power supply (option) | Plug-in | 0.5 to 1.5mm ² (24 to 14 AWG) rated 75°C | 7mm | 0.25N.m (2.25 Lb.In) | 0,4 x2,5mm |
| 9 | Not used | | | | | |

5.2 Connectors

5.2.1 View on lower face

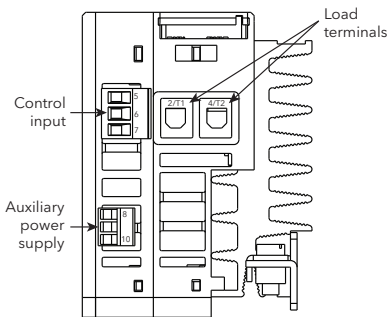

5.2.2 View on upper face

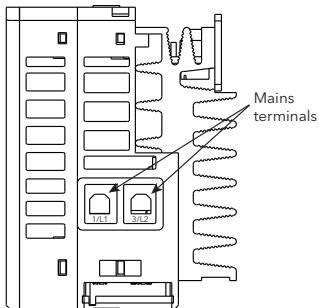

6. Control wiring

6.1 Input signal wiring

6.1.1 Remote Control

Example with an EFit driven by an analogue signal coming from the temperature controller

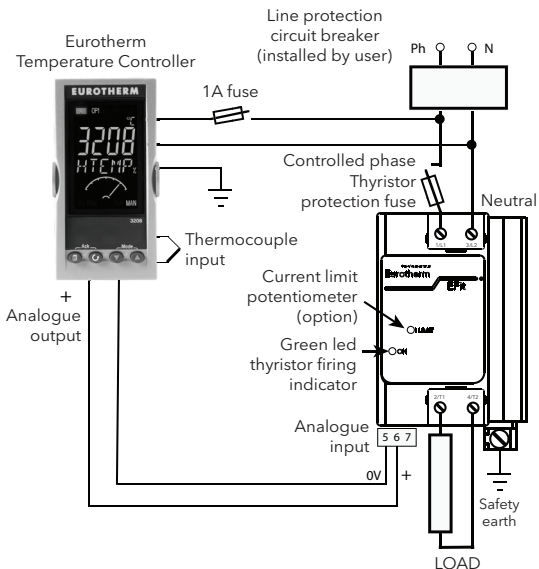

6.1.2 Local control by potentiometer

The input must be configured as 0 to 5V (code 0V5)

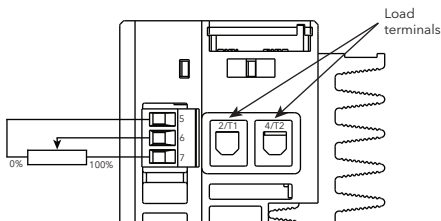

Wiring of the External potentiometer
(view on lower face)

6.1.3 Local control by contacts

The input must be configured as 0 to 5V (code 0V5).

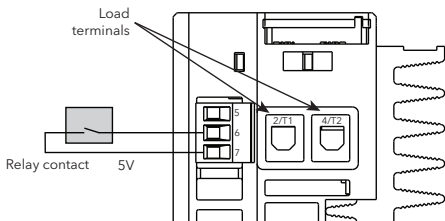

Wiring of the Relay Contact input
(view on lower face)

6.2 Auxiliary power supply (option)

In the case of non-standard mains, the auxiliary power supply must be in phase with the power supply voltage.

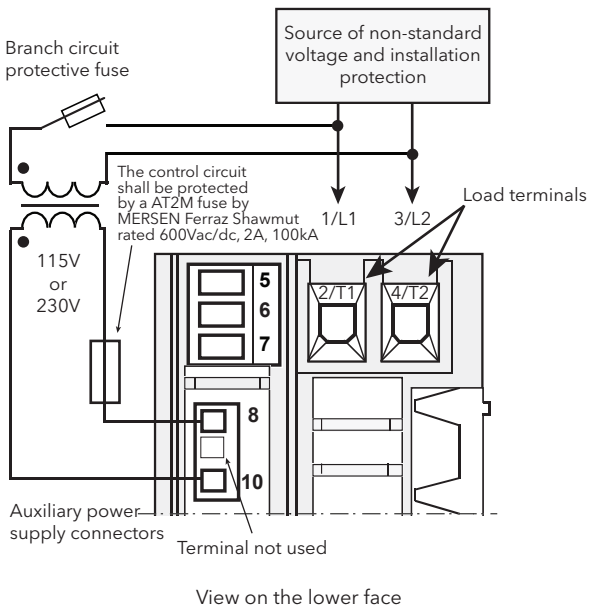

7. Current limit option (only available with phase angle firing mode)

7.1 Operation

The EFit controller features an adjustable rms load current limit. This function enables the user to limit the load current to a desired value independent of variation in load resistance. The current limit threshold can be set from 30% to 100% of the nominal current of the controller using the potentiometer labelled 'I LIMIT' on the front fascia.

7.2 Adjustment

Warning: This operation must be performed by suitable qualified and trained person.

Current limit adjustment is achievable if the rms load current is greater than or equal to 30% of the nominal current of the power controller. For this adjustment, use a flat bladed screw driver 2,5x0,4mm and a true rms ampmeter in order to minimise errors, which could otherwise amount to as much as 50% of the value of the current. For current limit adjustment, proceed as follows:

- Check that the load circuit is connected but not supplied
- Turn the potentiometer (labelled 'I LIMIT' on the front fascia) fully anti-clockwise (minimum position)
- Apply a 0% setpoint to the controller input
- If you have the 'Auxiliary power supply' option, switch on the auxiliary power supply
- Switch on the power circuit.
- Set the input signal at 100%.
- Turn slowly the current limit potentiometer clockwise and check that the current increases
- Adjust the potentiometer in order to reach the current limit value in the load.

8. THYRISTORS FIRING MODES

Four firing modes are proposed: Variable burst (or Fast cycle), Single-cycle, advanced Single-cycle and Phase Angle. For the burst modes (FC, FC1 and SCA codes), Thyristor firing and quenching occurs at **zero voltage** which reduce the interferences on the supply network.

8.1 Variable burst (or Fast cycle)

Variable burst (or Fast cycle) mode consists in supplying series of whole mains cycles to the load.

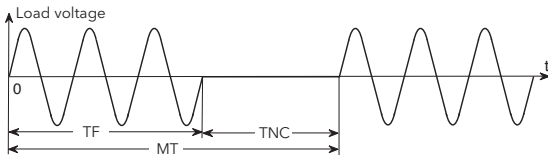

The load power is proportional to the ratio of the firing time (TF) to the modulation time (TM). The OFF time (TNF) is also a series of whole mains cycles. $TM = TF + TNF$

The period of modulation is **variable** according to the output power demand.

- At 50% of nominal power the thyristors are on for 16 periods and are off for 16 periods
- For a setpoint less than 50%, the **non-firing** period increases, and the firing period is fixed (16 periods)
- For a setpoint greater than 50%, the **firing** period increases, and it is the non-firing period which is fixed (16 periods)

8.2 Single-cycle

The mode of firing with only one firing or non-firing mains cycle is called **Single-cycle**.

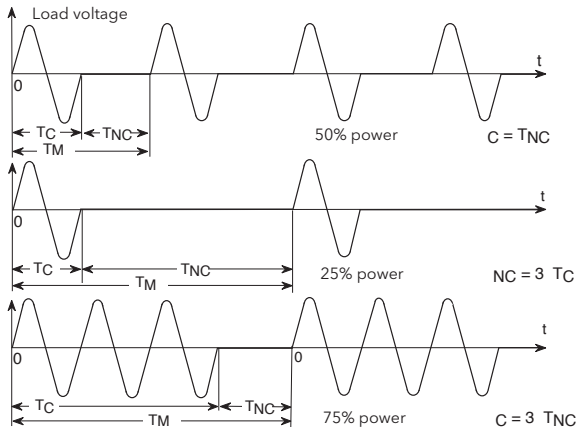

- At 50% of nominal power the thyristors are on for 20ms and are off for 20ms (at 50Hz)
- For a setpoint less than 50% the non-firing period increases and the **firing period is fixed** at 20ms
- For a setpoint greater than 50% the firing period increases and it is the **non-firing period which is fixed** at 20ms

8.3 Advanced Single-cycle

In order to minimise power fluctuation during the modulation period, the advanced Single-cycle mode uses half-cycles for non-firing duration.

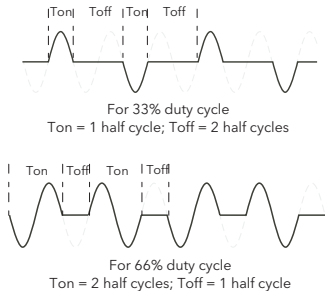

Examples of firing in Single-cycle (a) and in advanced Single-cycle (b) modes at 66.6% of nominal power.

- For a setpoint less than 50%, firing is effected on mains halfcycles. The firing time is fixed at one cycle (20ms at 50Hz)
- For a setpoint greater than 50%, **non-firing** is reduced to **one halfcycle**. Firing is effected over whole cycles.

The use of half-cycles for non-firing allows the reduction in flicker and brightness of infrared elements compared with Single-cycle.

8.4 Phase angle

In 'phase angle' thyristor firing mode the power transmitted to the load is controlled by firing the thyristors over part of the supply voltage half cycles.

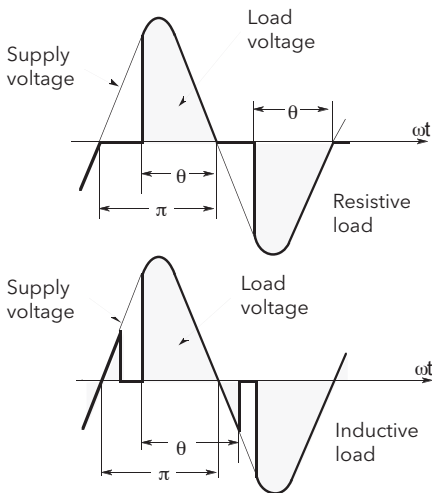

Load voltage in 'phase angle' firing mode (θ : thyristor firing angle)

9. Power control

9.1 Description

EFit controls on the square of the rms load voltage. Control precision is guaranteed at $\pm 2\%$ of the maximum voltage. The power controlled varies linearly from 0% to 100% of maximum power for an input signal variation from 4% to 96% of full scale. Linearity is better than $\pm 2\%$ of full scale.

9.2 Compensation of power supply fluctuations

Automatic compensation of supply variation is effective for fluctuations between +10 and -10% of the nominal voltage of the controller.

Control with this compensation device enable constant output power to be maintained on a constant load, despite variations in supply voltage.

Without compensation for supply variations, a reduction, for example, of 10% in supply voltage would result in a reduction of 20% in load power. Thanks to this compensation device the variation will be less than $\pm 2\%$.

10. Current derating

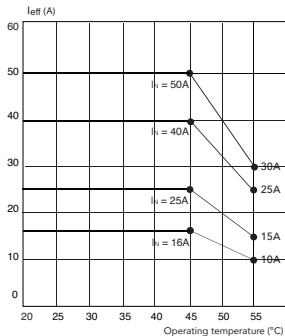

Current derating curves as a function of ambient temperature (I_N = nominal current at 45°C) for an altitude up to 1000m.

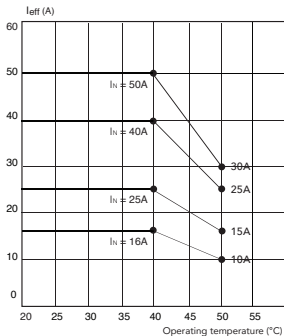

Current derating curves as a function of ambient temperature (I_N = nominal current at 40°C) for an altitude up to 2000m.

Eurotherm: International sales and service

ASEAN (Indonesia, Malaysia, Philippines, Singapore, Thailand, Vietnam)

Invensys Process Systems (S) Pte Ltd
T (+65) 6829 8888
F (+65) 6829 8401
E info.eurotherm.asean@invensys.com

AUSTRALIA Melbourne

Invensys Process Systems Australia Pty. Ltd.
T (+61 0) 8562 9800
F (+61 0) 8562 9801
E info.eurotherm.au@invensys.com

AUSTRIA Vienna

Eurotherm GmbH
T (+43 1) 7987601
F (+43 1) 7987605
E info.eurotherm.at@invensys.com

BELGIUM & LUXEMBOURG Moha

Eurotherm S.A./N.V.
T (+32) 85 274080
F (+32) 85 274081
E info.eurotherm.be@invensys.com

BRAZIL Campinas-SP

Eurotherm Ltda.
T (+5519) 3112 5333
F (+5519) 3112 5345
E info.eurotherm.br@invensys.com

CHINA

Eurotherm China
T (+86 21) 61451188
F (+86 21) 61452602
E info.eurotherm.cn@invensys.com
Beijing Office
T (+86 10) 5909 5700
F (+86 10) 5909 5709/10
E info.eurotherm.cn@invensys.com

FRANCE Lyon

Eurotherm Automation SA
T (+33 478) 664500
F (+33 478) 352490
E info.eurotherm.fr@invensys.com

GERMANY Limburg

Invensys Systems GmbH
>EUROTHERM<
T (+49 6431) 2980
F (+49 6431) 298119
E info.eurotherm.de@invensys.com

INDIA Mumbai

Invensys India Pvt. Ltd.
T (+91 22) 67579800
F (+91 22) 67579999
E info.eurotherm.in@invensys.com

IRELAND Dublin

Eurotherm Ireland Limited
T (+353 1) 4691800
F (+353 1) 4691300
E info.eurotherm.ie@invensys.com

ITALY Como

Eurotherm S.r.l.
T (+39 031) 975111
F (+39 031) 977512
E info.eurotherm.it@invensys.com

JAPAN Tokyo

Invensys Process Systems Japan, Inc.
T (+81 3) 6450 1092
F (+81 3) 5408-9220
E info.eurotherm.jp@invensys.com

KOREA Seoul

Invensys Operations Management Korea
T (+82 2) 2090 0900
F (+82 2) 2090 0800
E info.eurotherm.kr@invensys.com

NETHERLANDS Alphen a/d Rijn

Eurotherm B.V.
T (+31 172) 411752
F (+31 172) 417260
E info.eurotherm.nl@invensys.com

MIDDLE EAST AND NORTH AFRICA

UAE Dubai

Invensys Middle East FZE
T (+971 4) 8074700
F (+971 4) 8074777
E marketing.mena@invensys.com

POLAND Katowice

Invensys Eurotherm Sp z o.o.
T (+48 32) 7839500
F (+48 32) 7843608/7843609
E info.eurotherm.pl@invensys.com
Warsaw
Invensys Systems Sp z o.o.
T (+48 22) 8556010
F (+48 22) 8556011
E biuro@invensys-systems.pl

SPAIN Madrid

Eurotherm España SA
T (+34 91) 6616001
F (+34 91) 6619093
E info.eurotherm.es@invensys.com

SWEDEN Malmo

Eurotherm AB
T (+46 40) 384500
F (+46 40) 384545
E info.eurotherm.se@invensys.com

SWITZERLAND Wollerau

Eurotherm Produkte (Schweiz) AG
T (+41 44) 7871040
F (+41 44) 7871044
E info.eurotherm.ch@invensys.com

TAIWAN Kaohsiung

Invensys Taiwan
T (+886 7) 811-2269
F (+886 7) 811-9249
E apmarketing.iom@invensys.com
Taipei City Office

T (+886 2) 8797 1001

F (+886 2) 2799 7071

E apmarketing.iom@invensys.com

UNITED KINGDOM Worthing

Eurotherm Limited
T (+44 1903) 268500
F (+44 1903) 265982
E info.eurotherm.uk@invensys.com

U.S.A. Ashburn VA

Invensys Eurotherm
T (+1 703) 724 7300
F (+1 703) 724 7301
E info.eurotherm.us@invensys.com

ED70

Contact details correct at time of print

© Copyright Eurotherm Limited 2013

Invensys, Eurotherm, the Eurotherm logo, Chessell, EurothermSuite, Mini8, EPower, nanodac, piccolo, Eycen, Eyriss, versadac, optivis, Foxboro and Wonderware are trademarks of Invensys plc, its subsidiaries and affiliates. All other brands may be trademarks of their respective owners.

All rights are strictly reserved. No part of this document may be reproduced, modified or transmitted in any form by any means, neither may it be stored in a retrieval system other than for the purpose to act as an aid in operating the equipment to which the document relates, without the prior written permission of Eurotherm Limited.

Eurotherm Limited pursues a policy of continuous development and product improvement. The specifications in this document may therefore be changed without notice. The information in this document is given in good faith, but is intended for guidance only.

Eurotherm Limited will accept no responsibility for any losses arising from errors in this document