



AP1080 (Single Trip, DPDT, 5A)  
AP1090 (Single/Dual Trip, 2 SPDT, 5A)

# Action PAK® AP1080 & AP1090

## DC Input, Field Configurable Limit Alarms

Provides Relay Contact Closures  
at a Preset DC Input Level



- Field Configurable Input Ranges for DC Voltage and Current
- Exclusive “Dynamic Deadband” Prevents False Trips
- Setpoints Programmable HI or LO
- Selectable Failsafe/Latching Operation
- Selectable 120/240VAC Input Power (9 to 30 VDC Available)

### Description

Action Pak models AP1080 single setpoint and AP1090 dual setpoint limit alarms offer flexible, wide-ranging DC input capability. Voltage spans from 10mV to 200 volts and current spans from 1mA to 100mA can be field configured. Bipolar inputs are also accepted. Both models offer configurable latching, failsafe and HI/LO operation. The AP1080 and AP1090 also include 0.25%-50% adjustable deadbands and selectable 120/240VAC input power.

### Diagnostic LED

Models AP1080-2000 and AP1090-2000 are equipped with a dual function diagnostic LED. The green center LED indicates line power and input signal status. Active line power is indicated by an illuminated LED. If the center LED is off, check line power and the wiring connection. If the input signal is above 100% full scale, the LED will flash at approximately 8Hz. Below 0%, the flash rate is approximately 4Hz.

### Output Selection

The single setpoint AP1080 and the dual setpoint AP1090 provide the following relay outputs:

- AP1080** Single Trip (DPDT, 5A)
- AP1090** Single/Dual Trip (2 SPDT, 5A)

Setpoints are top accessed multi-turn potentiometers or option "P" provides top mounted ten-turn dials.

### Operation

The field configurable AP1080 and AP1090 limit alarm setpoints can be configured for HI, LO, latching or failsafe trip operation. Non-latching HI and LO setpoints have respective HI and LO deadbands. In a tripped condition, the setpoint is exceeded and the appropriate red LED will illuminate. The trip will reset only when the process falls below the HI deadband or rises above the LO deadband (see figure 1). To reset a latched setpoint the signal must be in the safe region and the line power turned off for at least 5 seconds. For proper deadband operation, a HI setpoint must always be set above a LO setpoint.

In failsafe operation, the relay is energized when the process is below the HI setpoint or above the LO setpoint (opposite for non-failsafe). In the failsafe mode, the relays go to the tripped condition when the power fails.

### Dynamic Deadband

The input must remain beyond the setpoint for 100 milliseconds, uninterrupted, to qualify as a valid trip condition. Likewise, the input must fall outside the deadband and remain there for 100 milliseconds to return the alarm to an untripped condition. This effectively results in a “dynamic deadband” - based on time - in addition to the normal deadband.

### Options

- U** Urethane coating of internal circuitry for protection from corrosive atmospheres.
- P** Top Mounted, Ten-Turn Dial(s) for setpoint adjustment.
- C620** Factory calibration to input range, setpoints and output relays. Not available with option P.

### Configuration

The factory presets models AP1080 and AP1090 as follows:

	AP1080	AP1090
Input	0-20mA	0-20mA
Output	Single, DPDT	Dual, SPDT
Trip	HI	A: HI, B: LO
Latching	No	No
Failsafe	Yes	No
Deadband	0.25%	A/B: 0.25%
Power	120VAC	120VAC

For other I/O ranges, remove the four base screws and case to access the configuration switches.

Replace the cover before applying power.

Refer to Figure 5 for switch locations.

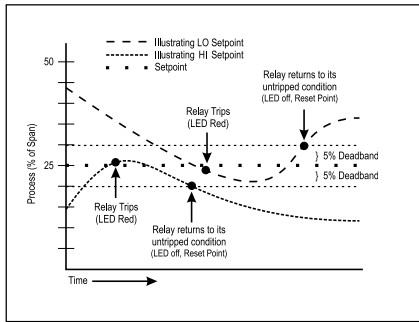

Figure 1: Limit alarm operation and effect of deadband.

### Input

1. Position input jumper “W2” for Current or Voltage inputs.



2. Set position 1 of the Mode Selector for Unipolar or Bipolar operation. Unipolar is the default.

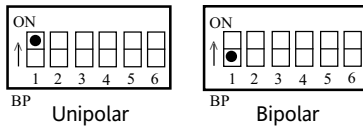

Note: A bipolar span selection will double any span from Table 1 (e.g., 10V unipolar span = ±10V bipolar span)

3. Using Table 1, configure positions 1 through 4 of the Input Range Selector for the desired maximum setpoint input. Round desired maximum input values to the next highest range (e.g., 0-120V = 200V range).

### Output

Configure the Mode Selector for the required function. See Figure 6.

### Power

Configure the AC jumpers for either 120 or 240 VAC operation. See Figure 4.

### Calibration

Note: To maximize thermal stability, final calibration should be performed in the operating installation, allowing approximately 1-2 hours for warmup and thermal equilibrium of the system.

**Setpoint:** Set deadband at its minimum (factory default - 20 turns Counter Clockwise) before adjusting the setpoint. With the specified trip voltage or current input applied, adjust setpoint until the relay trips. For HI trip calibration, start with the setpoint above the desired trip. For LO trip calibration, start below the desired trip.

**Deadband:** Set deadband to its minimum (factory default - fully CCW). Set setpoint to desired trip. Adjust voltage/current input until relay trips. Readjust deadband to 50% (20 turns CW). Set voltage/current input to desired deadband position. Slowly adjust deadband until relay untrips.

Note that Custom Calibration (option C620) is available from the factory (settings **MUST** be within specifications):

a) Setpoint A: Type (HI/LO); Units (mA, mV, V); Deadband (%)

b) Setpoint B (1090 only): Type (HI/LO); Units (mA, mV, V); Deadband (%)

c) Latching (ON/OFF)

d) Failsafe (ON/OFF)

Note that if a deadband entry is not specified, the default entry will be used.

### Relay Protection and EMI Suppression

When switching inductive loads, maximum relay life and transient EMI suppression is achieved using external protection (see Figures 2 & 3). Place all protection devices directly across the load and minimize all lead lengths. For AC inductive loads, place a properly-rated MOV across the load in parallel with a series RC snubber. Use a 0.01 to 0.1mF pulse film capacitor (foil polypropylene recommended) of sufficient voltage, and a 47ohm, 1/2W carbon resistor. For DC inductive loads, place a diode across the load (PRV > DC supply, 1N4006 recommended) with (+) to cathode and (-) to anode (the RC snubber is an optional enhancement).

Table 1: AP1080-2000 and 1090-2000 Input Ranges

*Voltage	*Current	Input Range Selector
10mV	1mA	
20mV	2mA	
50mV	5mA	
100mV	10mA	
200mV	20mA	
500mV	50mA	
1V	100mA	
2V		
5V		
10V		
20V		
50V		
100V		
200V		

\*Note: Use Jumper (W2) to configure either voltage or current input. All unipolar input ranges are zero based.

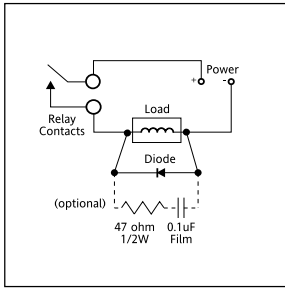

Figure 2: DC Inductive Loads

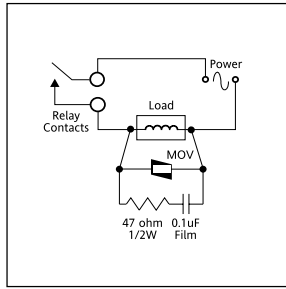
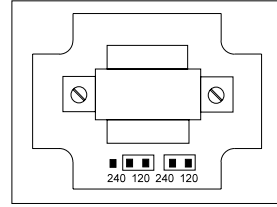
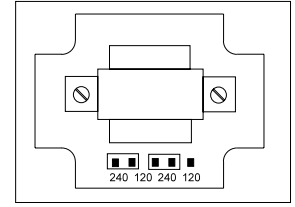

Figure 3: AC Inductive Loads



120 VAC Operation



240 VAC Operation

Figure 4: 120/240 VAC Selection

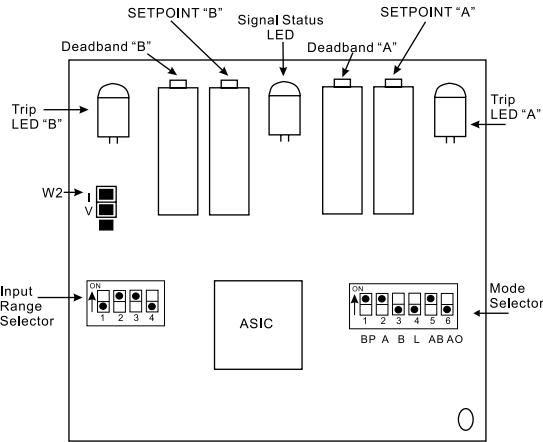

Figure 5: AP1090-2000 Factory Calibration 0-20mA, Dual HI/LO, Non-Latching, Non-Failsafe.

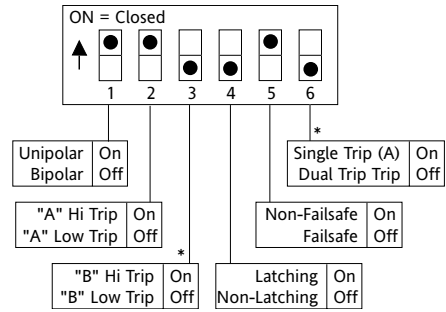

Figure 6: Mode Selection Dual Trip/A: HI, B: LO, Non-Latching, Non-Failsafe \*AP1090-2000 only.

**Mounting**

All Action Paks feature plug-in installation. Models AP1080 and AP1090 use an 11-pin base, either molded socket (M011) or DIN rail socket (MD11).

**Dimensions**

Dimensions are in millimeters (inches)

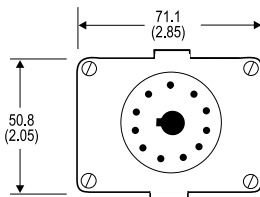
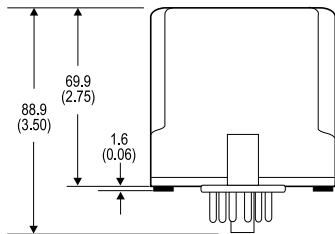

Mark III

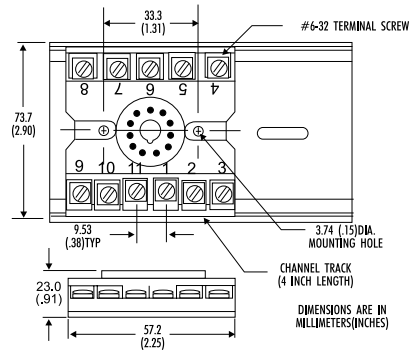

M011 (Track/Surface)

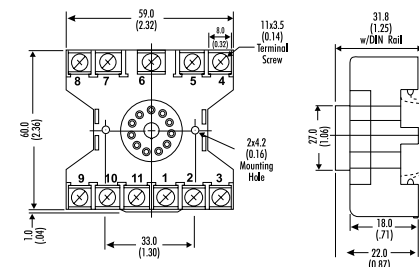

MD11 (DIN Rail)

## Specifications

### Inputs:

Voltage Input:  
Range: 10mV to 200V  
Impedance: >100Kohms  
Overvoltage: 400V, max  
Current Input:  
Range: 1mA to 100mA  
Impedance: 20ohms, typical  
Overcurrent: 200mA, max  
Overvoltage: 60VDC  
Common Mode (Input to Ground):  
1000VDC, max

### LED Indications:

Input Range (Green)  
>100% input: 8Hz flash  
<0% input: 4Hz flash  
Setpoint (Red)  
Tripped: Solid red  
Safe: Off

### Limit Differential (Deadband):

>50mV/5mA: 0.25% to 50% of span  
<50mV/5mA: 1% to 50% of span

### Response Time:

Dynamic Deadband:  
Relay status will change when proper setpoint/process condition exists uninterrupted for 100msec.  
Normal Mode (analog filtering):  
<250msec, (10-90%)

### Setpoint:

Effectivity:  
Setpoints are adjustable over 100% of the selected input span.  
Repeatability (constant temp):  
>50mV/5mA: 0.1% of full scale  
<50mV/5mA: 0.2% of full scale

### Stability:

Line Voltage:  $\pm 0.01\%/%$ , max.  
Temperature:  $\pm 0.05\%$  of full scale/ $^{\circ}\text{C}$ , max.

### Common Mode Rejection:

DC to 60Hz: 120dB

### Isolation:

1000VDC between contacts, input & power

### ESD Susceptibility:

Meets IEC 801-2, Level 2 (4KV)

### Humidity:

Operating: 15 to 95% (@45 $^{\circ}\text{C}$ )  
Soak: 90% for 24 hours (@65 $^{\circ}\text{C}$ )

### Temperature Range:

Operating: 0 to 60 $^{\circ}\text{C}$  (32 to 140 $^{\circ}\text{F}$ )  
Storage: -15 to 70 $^{\circ}\text{C}$  (5 to 158 $^{\circ}\text{F}$ )

### Power:

Consumption: 2W typical, 5W max.  
Standard:  
Selectable 120/ 240VAC ( $\pm 10\%$ , 50-60Hz)  
Optional:  
9 to 30VDC, Inverter-Isolated

### Relay Contacts:

AP1080: DPDT (2 Form C)  
AP1090: 1 SPDT (1 Form C) per setpoint  
Current Rating (resistive)  
120VAC: 5A; 240VAC: 2A; 28VDC: 5A  
Material: Silver-Cadmium Oxide  
Electrical Life: 10<sup>5</sup> operations at rated load  
*Note: External relay contact protection is required for use with inductive loads. See relay protection section (Fig 2 & 3).*  
Mechanical Life: 10<sup>7</sup> operations

### Latch Reset Time:

5 seconds

### Weight:

AP1080: 0.46lbs; AP1090: 0.62lbs

### Agency Approvals:

UL recognized per standard UL508,  
(File No. E99775)

## Ordering Information

### Specify:

1. Model: **AP1080-2000, AP1090-2000**
2. Options: U, P (see text)
3. Line Power (see specs.)(All power supplies are transformer-isolated from the internal circuitry.)
4. C620 Custom Calibration? (see Options)

### Accessories:

M801-0000 Retaining Spring  
M011-A 11 pin Track Mount Socket  
M004-0000 4 ft Long Channel Track  
MD11-0000 11 pin DIN Mount Socket

## Pin Connections

- 1 AC Power (Hot)
- 2 No Connection
- 3 AC Power (Neu)
- 4 Input (+)
- 5 Input (-)
- 6 (A) N.O.
- 7 (A) C
- 8 (A) N.C.
- 9 (B) N.O.
- 10 (B) C
- 11 (B) N.C.

### Key:

N.O. = Normally Open  
C = Common  
N.C. = Normally Closed  
DC Power: Pin 1 = (+)  
Pin 3 = (-)

\*Contacts are in the "normal" state when the relay is de-energized.



### Eurotherm, Inc

741-F Miller Drive  
Leesburg, VA 20175-8993  
703-443-0000

[info@eurotherm.com](mailto:info@eurotherm.com) or [www.eurotherm.com/actionio](http://www.eurotherm.com/actionio)



Printed on recycled paper

## Factory Assistance

For additional information on calibration, operation and installation contact our Technical Services Group:

**703-669-1318**

[actionsupport@eurotherm.com](mailto:actionsupport@eurotherm.com)

721-0479-00-0 02/09 Copyright© Eurotherm, Inc 2009