

BDN C-D11-DN-EDN-01-060M
BCC0765

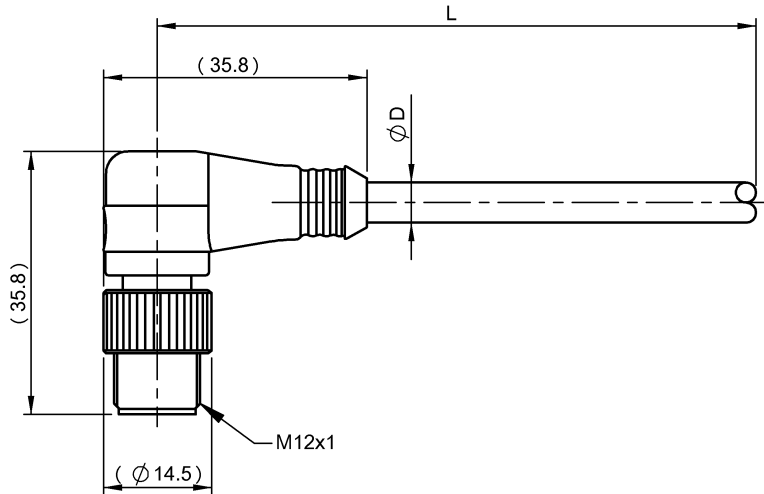

Electrical connection

Bending radius min., fixed cable	3 x D
Bending radius min., flexible cable	12 x D
Cable	PVC Shielded gray, 6.00 m
Cable diameter D	6.90 mm
Conductor cross-section	AWG 22
Number of conductors	4
Number of pins	5
System	Molded

Electrical data

Conductor construction	2x2 twisted-pair
Rated current (40 °C)	4.0 A

Environmental conditions

Ambient temperature	-20... 105 °C
Protection type IEC 60529	IP68

General data

Application	DeviceNet Thin
Approval/Conformity	cCSAus

Material

Material contact carrier	PVC
Material contacts	Brass
Material cover nut	Zincepoxy coated
Material grip	PVC

Mechanical data

Tightening torque pigtail	0.6 Nm
---------------------------	--------

Remarks

Enclosure rating per IEC 60529, only in screwed state with the associated mating piece.

BDN C-D11-DN-EDN-01-060M
BCC0765

Connector view

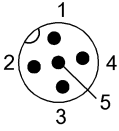

Wiring Diagram

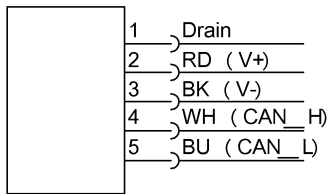

L