

Professionally approved products.

Datasheet

8P 270 DIN Socket Chassis Mount

RS Stock number 491-106



Specifications:

Rating:	100V AC 4A max.
Contact Resistance:	pins-30m Ω max; shell-50m Ω max.
Insulation Resistance:	100M Ω min. at 500V DC
Dielectric Strength:	250V AC R.M.S. for 1 minute

Dimensions(mm)

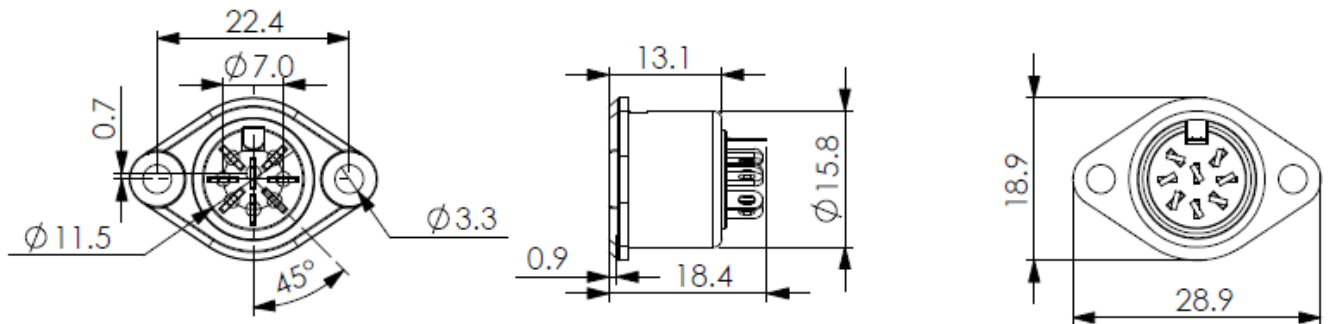

Professionally approved products. Datasheet

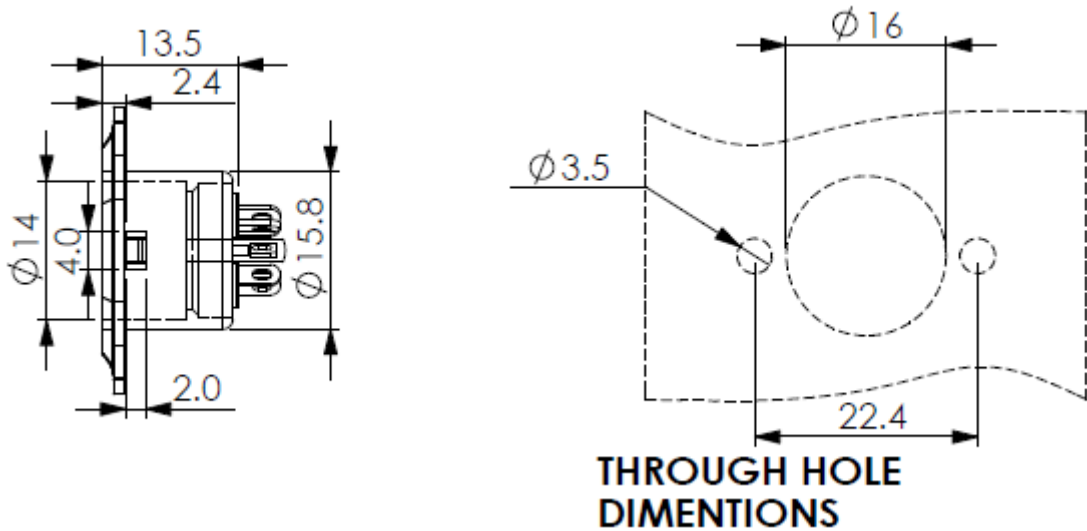

No.	Description	Material	Treat
1	Shield Cover	Zn Alloy	Nickel Ptd.
2	Negative Contact	Copper	Nickel Ptd.
3	Terminals	Brass	Silver Ptd.
4	Housing	ABS	